

# **Vancouver Building By-law 2025**

**Book I: General  
(Volume 2)**

# Part 9

## Housing and Small Buildings

### Section 9.1. General

#### 9.1.1. Application

##### 9.1.1.1. Application

1) The application of this Part shall be as described in Subsection 1.3.3. of Division A. (See Note A-9.1.1.1.(1) regarding application to seasonally and intermittently occupied *buildings*.)

2) When an *existing building* is altered and the *alteration* triggers upgrading as determined in Division B Section 11.2., the alternative *acceptable* solutions provided in Division B, Part 11 may apply in lieu of the requirements of this Part. (See Article 1.1.1.2. of Division A.)

#### 9.1.2. Reserved

### Section 9.2. Definitions

#### 9.2.1. General

##### 9.2.1.1. Defined Words

1) Words in italics are defined in Article 1.4.1.2. of Division A.

### Section 9.3. Materials, Systems and Equipment

#### 9.3.1. Concrete

##### 9.3.1.1. General

1) Except as provided in Sentence (2) and Articles 9.3.1.6. and 9.3.1.7., unreinforced and nominally reinforced concrete shall be designed, mixed, placed, cured and tested in accordance with the requirements for “R” class concrete stated in Section 9 of CSA A23.1, “Concrete materials and methods of concrete construction.”

2) Unreinforced and nominally reinforced site-batched concrete shall be designed, mixed, placed and cured in accordance with Articles 9.3.1.2. to 9.3.1.9.

3) Except as provided in Sentence (4), reinforced concrete shall be designed to conform to the requirements of Part 4.

4) For flat insulating concrete form walls not exceeding 2 *storeys* in *building height* and having a maximum floor to floor height of 3 m, in *buildings* of light-frame construction, the concrete and reinforcing shall comply with Part 4 or

a) the concrete shall conform to CSA A23.1, “Concrete materials and methods of concrete construction,” with a maximum aggregate size of 19 mm, and

b) the reinforcing shall

i) conform to CSA G30.18, “Carbon steel bars for concrete reinforcement,”

ii) have a minimum specified yield strength of 400 MPa, and

iii) be lapped a minimum of 450 mm for 10M bars and 650 mm for 15M bars (see also Articles 9.15.4.5. and 9.20.17.2. to 9.20.17.4.).

#### **9.3.1.2. Cement**

1) Cement shall meet the requirements of CSA A3001, "Cementitious Materials for Use in Concrete."

#### **9.3.1.3. Concrete in Contact with Sulphate Soil**

1) Concrete in contact with sulphate *soil*, which is deleterious to normal cement, shall conform to the requirements in Clause 4.1.1.6 of CSA A23.1, "Concrete materials and methods of concrete construction."

#### **9.3.1.4. Aggregates**

1) Aggregates shall

a) consist of sand, gravel, crushed *rock*, crushed air-cooled blast *furnace* slag, expanded shale or expanded clay conforming to CSA A23.1, "Concrete materials and methods of concrete construction," and

b) be clean, well-graded and free of injurious amounts of organic and other deleterious material.

#### **9.3.1.5. Water**

1) Water shall be clean and free of injurious amounts of oil, organic matter, sediment or any other deleterious material.

#### **9.3.1.6. Compressive Strength**

(See also Article 9.12.4.1., Sentence 9.15.4.2.(1) and Article 9.18.6.1.)

1) Except as provided elsewhere in this Part, the compressive strength of unreinforced concrete after 28 days shall be not less than

a) 15 MPa for walls, columns, fireplaces and *chimneys*, footings, *foundation* walls, grade beams and piers,

b) 20 MPa for floors other than those in garages and carports, and

c) for garage and carport floors, and the exterior steps,

i) 32 MPa, or

ii) 30 MPa where indigenous aggregates do not achieve 32 MPa with a 0.45 water to cementing material ratio.

2) Site-batched concrete used for garage and carport floors and exterior steps shall have air entrainment of 5 to 8%.

#### **9.3.1.7. Concrete Mixes**

(See Note A-9.3.1.7.)

1) For pre-mixed concrete and for the site-batched concrete mixes described in Table 9.3.1.7., the maximum ratio of water to cementing materials measured by weight shall not exceed

a) 0.70 for walls, columns, fireplaces and *chimneys*, footings, *foundation* walls, grade beams and piers,

b) 0.65 for floors other than those in garages and carports, and

c) 0.45 for garage and carport floors, and exterior steps.

**Table 9.3.1.7.**  
**Site-Batched Concrete Mixes**  
**Forming Part of Sentence 9.3.1.7.(1)**

Maximum Size of Coarse Aggregate, mm	Materials, volume					
	Cementing Material		Fine Aggregate (damp average coarse sand)		Coarse Aggregate (gravel or crushed stone)	
	Parts <sup>(1)</sup>	L	Parts	L	Parts	L
14	1	28	1.75	49	2	56
20	1	28	1.75	49	2.5	70
28	1	28	2	56	3	84
40	1	28	2	56	3.5	98

**Notes to Table 9.3.1.7.:**

<sup>(1)</sup> 1 part cementing material = 1 × 40 kg bag

2) The size of aggregate in unreinforced site-batched concrete mixes referred to in Sentence (1) shall not exceed

- a) 1/5 the distance between the sides of vertical forms, or
- b) 1/3 the thickness of flatwork.

**9.3.1.8. Admixtures**

1) Admixtures shall conform to ASTM C260, “Standard Specification for Air-Entraining Admixtures for Concrete,” or ASTM C494/C494M, “Standard Specification for Chemical Admixtures for Concrete,” as applicable.

**9.3.1.9. Cold Weather Requirements**

- 1) When the air temperature is below 5°C, concrete shall be
  - a) kept at a temperature of not less than 10°C or more than 25°C while being mixed and placed, and
  - b) maintained at a temperature of not less than 10°C for 72 h after placing.
- 2) No frozen material or ice shall be used in concrete described in Sentence (1).

**9.3.2. Lumber and Wood Products**

**9.3.2.1. Grade Marking**

1) Lumber for joists, rafters, trusses and beams and for the uses listed in Table 9.3.2.1. shall be identified by a grade stamp to indicate its grade as determined by NLGA 2017, “Standard Grading Rules for Canadian Lumber.” (See Note A-9.3.2.1.(1).)

**Table 9.3.2.1.**  
**Minimum Lumber Grades for Specific End Uses**  
**Forming Part of Sentence 9.3.2.1.(1)**

Use	Boards <sup>(1)</sup>	Framing
	Paragraph in the NLGA Grading Rules under which boards are graded	

	All Species		Eastern White Pine & Red Pine	All Species
	Para 113	Para 114	Para 118	
Stud wall framing ( <i>loadbearing</i> members)	—	—	—	Stud, Standard, No. 2
Stud wall framing ( <i>non-loadbearing</i> members)	—	—	—	Stud, Utility, No. 3
Plank frame construction ( <i>loadbearing</i> members)	No. 3 Common	—	No. 3 Common	No. 2
Plank frame construction ( <i>non-loadbearing</i> members)	No. 5 Common	—	No. 5 Common	Economy, No. 3
Posts and beams less than 114 mm in thickness	—	—	—	Standard, No. 2
Posts and beams not less than 114 mm in thickness	—	—	—	Standard
Roof sheathing	No. 3 Common	Standard	No. 4 Common	—
Subflooring	No. 3 Common	Standard	No. 3 Common	—
Wall sheathing when required as a nailing base	No. 4 Common	Utility	No. 4 Common	—
Wall sheathing not required as a nailing base	No. 5 Common	Economy	No. 5 Common	—

**Notes to Table 9.3.2.1.:**

<sup>(1)</sup> See Note A-Table 9.3.2.1.

**9.3.2.2. Lumber Grades**

1) Except for joists, rafters, trusses and beams, visually graded lumber shall conform to the grades in Table 9.3.2.1. (See Article 9.23.4.2. for joists, rafters and beams and Article 9.23.14.11. for trusses.)

**9.3.2.3. Machine Stress Rated Lumber**

1) Machine stress rated lumber shall conform to the requirements of Subsection 4.3.1.

**9.3.2.4. OSB, Waferboard and Plywood Marking**

1) OSB, waferboard and plywood used for roof sheathing, wall sheathing and subflooring shall be legibly identified on the face of the material indicating

- a) the manufacturer of the material,
- b) the standard to which it is produced, and
- c) that the material is of an exterior type.

**9.3.2.5. Moisture Content**

1) Moisture content of lumber shall be not more than 19% at the time of installation.

**9.3.2.6. Lumber Dimensions**

1) Lumber dimensions referred to in this Part are actual dimensions determined in conformance with CSA O141, "Softwood Lumber."

### **9.3.2.7. Panel Thickness Tolerances**

1) The thicknesses specified in this Part for plywood, hardboard, particleboard, OSB and waferboard shall be subject to the tolerances permitted in the standards referenced for these products unless specifically indicated herein.

### **9.3.2.8. Undersized Lumber**

1) Joist, rafter, lintel and beam members up to 5% less than the actual Canadian standard sizes are permitted to be used provided the allowable spans for the grade and species of lumber under consideration are reduced 5% from those shown in the Span Tables for full size members. (See Note A-9.3.2.8.(1).)

### **9.3.2.9. Termite and Decay Protection**

1) In localities where termites are known to occur,

a) clearance between structural wood elements and the finished ground level directly below them shall be not less than 450 mm and, except as provided in Sentence (2), all sides of the supporting elements shall be visible to permit inspection, or

b) structural wood elements, supported by elements in contact with the ground or exposed over bare soil, shall be pressure-treated with a chemical that is toxic to termites.

(See Note A-9.3.2.9.(1).)

2) In localities where termites are known to occur and *foundations* are insulated or otherwise finished in a manner that could conceal a termite infestation,

a) a metal or plastic barrier shall be installed through the insulation and any other separation or finish materials above finished ground level to control the passage of termites behind or through the insulation, separation or finish materials, and

b) all sides of the finished supporting assembly shall be visible to permit inspection.

3) Structural wood elements shall be pressure-treated with a preservative to resist decay,

a) where the vertical clearance between structural wood elements and the finished ground level is less than 150 mm (see also Articles 9.23.2.2. and 9.23.2.3.), or

b) where

i) the wood elements are not protected from exposure to precipitation,

ii) the configuration is conducive to moisture accumulation, and

iii) the moisture index is greater than 1.00.

(See Note A-9.3.2.9.(3).)

4) Structural wood elements used in retaining walls and cribbing shall be pressure-treated with a preservative to resist decay, where

a) the retaining wall or cribbing supports ground that is critical to the stability of *building foundations*, or

b) the retaining wall or cribbing is greater than 1.2 m in height.

(See Note A-9.3.2.9.(4).)

5) Where wood is required by this Article to be treated to resist termites or decay, such treatment shall be in accordance with Table 2, Use Categories for Specific Products, Uses, and Exposures, of CAN/CSA-O80.1, "Specification of treated wood," as follows:

- a) Use Category 1 (UC1), where the wood member is used in
  - i) interior *construction*,
  - ii) above-ground applications, and
  - iii) applications where the wood member remains dry,
- b) Use Category 2 (UC2), where the wood member is used in
  - i) interior *construction*,
  - ii) above-ground applications, and
  - iii) applications where the wood member may be subjected to occasional sources of moisture,
- c) Use Category 3.2 (UC3.2), where the wood member is used in
  - i) exterior *construction*,
  - ii) above-ground applications, and
  - iii) applications where the wood member is uncoated or is used in a configuration conducive to moisture accumulation,
- d) Use Category 4.1 (UC4.1), where
  - i) the wood member is in contact with the ground,
  - ii) the wood member is in contact with fresh water, or
  - iii) the vertical clearance between the wood element and the finished ground level is less than 150 mm and the wood elements are not separated from permeable supporting materials by a moisture barrier, or
- e) Use Category 4.2 (UC4.2), where the wood member is used in critical structural components, including permanent wood *foundations*.
- 6) Where wood is protected in accordance with UC1 or UC2 using an inorganic boron preservative, the wood shall be
  - a) protected from direct exposure to water during and after the completion of construction, and
  - b) separated from permeable supporting materials by a moisture barrier that is resistant to all expected mechanisms of deterioration in the service environment if the vertical clearance to the ground is less than 150 mm.
- 7) Wood that is required by this Article to be treated to resist termites or decay shall be identified by a mark to indicate the type of preservative used and conformance to the relevant required Use Category.

### **9.3.3. Metal**

#### **9.3.3.1. Sheet Metal Thickness**

1) Minimum thicknesses for sheet metal material that are stated in this Part refer to the actual minimum base metal thicknesses measured at any point of the material and, in the case of galvanized steel described in Sentence 9.3.3.2.(1), include the thickness of the galvanizing coating unless otherwise indicated.

#### **9.3.3.2. Galvanized Sheet Steel**

1) Where sheet steel is required to be galvanized, it shall be metallic-coated with zinc or an alloy of 55% aluminum-zinc meeting the requirements of

a) ASTM A653/A653M, "Standard Specification for Steel Sheet, Zinc-Coated (Galvanized) or Zinc-Iron Alloy-Coated (Galvannealed) by the Hot-Dip Process," or

b) ASTM A792/A792M, "Standard Specification for Steel Sheet, 55% Aluminum-Zinc Alloy-Coated by the Hot-Dip Process."

2) Where galvanized sheet steel is intended for use in locations exposed to the weather or as a flashing material, it shall have a zinc coating not less than the G90 [Z275] coating designation or an aluminum-zinc alloy coating not less than the AZM150 coating designation, as referred to in Sentence (1).

## **Section 9.4. Structural Requirements**

### **9.4.1. Structural Design Requirements and Application**

#### **Limitations**

##### **9.4.1.1. General**

(See Note A-9.4.1.1. and Article 2.2.7.6. of Division C. )

1) Subject to the application limitations defined elsewhere in this Part, structural members and their connections shall

a) conform to requirements provided elsewhere in this Part,

b) be designed according to good engineering practice such as that provided in the CWC, "Engineering Guide for Wood Frame Construction," or

c) be designed according to Part 4 using the loads and deflection and vibration limits specified in

i) Part 9, or

ii) Part 4.

2) Where floor framing is designed in accordance with Clause (1)(b) or (c), and where supporting wall framing and fastenings, or footings are designed according to Clause (1)(a), the maximum specified *live load* on the floor according to Table 4.1.5.3. shall not exceed 2.4 kPa.

3) Location-specific information for structural design, including snow and wind loads and seismic design parameter, shall be determined according to Subsection 1.1.3.

4) A *registered professional* who undertakes design work and *field review* for the structural design of a *building of residential occupancy* containing not more than two principal *dwelling units* shall provide a note on the structural drawings which provides assurance that the design of the structure has been reviewed for resistance to the structural requirements of Division B Section 9.4.

### **9.4.2. Specified Loads**

#### **9.4.2.1. Application**

(See Note A-9.4.2.1. and 9.4.2.2.)

1) This Subsection applies to light-frame constructions whose wall, floor and roof planes are generally comprised of frames of small repetitive structural members, and where

a) the roof and wall planes are clad, sheathed or braced on at least one side,



- b) the small repetitive structural members are spaced not more than 600 mm o.c.,
- c) the clear span of any structural member does not exceed 12.2 m,
- d) the maximum deflection of the structural roof members conforms to Article 9.4.3.1.,
- e) the maximum total roof area, notwithstanding any separation of adjoining *buildings* by *firewalls*, is 4 550 m<sup>2</sup>, and
- f) for flat roofs, there are no significant obstructions on the roof, such as parapet walls, spaced closer than the distance calculated by

$$D_o = 10(H_o - 0.8S_s/\gamma)$$

where

$D_o$  = minimum distance between obstructions, m,

$H_o$  = height of the obstruction above the roof, m,

$S_s$  = ground snow load, kPa, and

$\gamma$  = specific weight of snow taken as 4.0 kN/m<sup>3</sup> or 0.43 $S_s$  + 2.2 kN/m<sup>3</sup>, whichever is lesser.

#### 9.4.2.2. Specified Snow Loads

(See Note A-9.4.2.1. and 9.4.2.2.)

- 1) Except as provided in Sentences (2) to (4), specified snow loads shall be not less than those calculated using the following formula:

$$S = C_b S_s + S_r$$

where

$S$  = specified snow load,

$C_b$  = basic snow load roof factor, which is 0.45 where the entire width of the roof does not exceed 4.3 m and 0.55 for all other roofs,

$S_s$  = 1-in-50-year ground snow load in kPa, determined according to Subsection 1.1.3., and

$S_r$  = associated 1-in-50-year rain load in kPa, determined according to Subsection 1.1.3.

- 2) In no case shall the specified snow load be less than 1 kPa.
- 3) Bow string, arch or semi-circular roof trusses having an unsupported span greater than 6 m shall be designed in conformance with the snow load requirements in Subsection 4.1.6.
- 4) Where the height of a roof step at the intersection of an upper level roof and a lower level roof is greater than 2 m, and the upper level roof has a slope less than 1 in 6 and an area greater than 600 m<sup>2</sup>, the specified snow load on the lower level roof shall be
  - a) for distances from the roof step that are less than or equal to the drift length,  $x_d$ , calculated in accordance with Sentence (5), not less than 1.5 times the specified snow load,  $S$ , calculated using the formula in Sentence (1) with  $C_b$  equal to 0.55, and
  - b) for distances from the roof step that are greater than the drift length,  $x_d$ , calculated in accordance with Sentence (5), as specified in Sentence (1).
- 5) For the purposes of Sentence (4), the drift length,  $x_d$ , in m, shall be calculated as follows:

$$x_d = 5 \left( h - \frac{0.55 S_s}{\gamma} \right)$$

where

$h$  = height of the roof step, in m, and

$\gamma$  = specific weight of snow as specified in Clause 9.4.2.1.(1)(f).

**9.4.2.3. Platforms Subject to Snow and Occupancy Loads**

1) Balconies, decks and other accessible exterior platforms intended for an *occupancy* and subject to snow loads shall be designed to carry the specified roof snow load or 1.9 kPa, whichever is greater, where the platform, or each segregated area of the platform, serves a single *dwelling unit*. (See Note A-9.4.2.3.(1).)

**9.4.2.4. Attics and Roof Spaces**

1) The ceiling joists or truss bottom chords in residential *attic or roof spaces* having limited accessibility that precludes the storage of equipment or material shall be designed for a total specified load of not less than 0.35 kPa, where the total specified load is the sum of the specified *dead load* plus the specified *live load* of the ceiling. (See Note A-9.4.2.4.(1).)

**9.4.2.5. Seismic Design Parameter**

(See Note A-9.4.2.5.)

1) Except as provided in Sentence (2) and unless otherwise indicated, the value of the seismic design parameter,  $S_{max}$ , at a location listed in Table C-3 of Appendix C shall be taken as  $S_{max}$  for unknown Site Class.

2) Where the Site Class is determined in accordance with Sentence 4.1.8.4.(3), the value of the seismic design parameter,  $S_{max}$ , at a location listed in Table C-3 of Appendix C, is permitted to be taken as  $S_{max}$  for the value for the determined Site Class. (See Note A-9.4.2.5.(2).)

**9.4.3. Deflections**

**9.4.3.1. Deflections**

- 1) The maximum deflection of structural members shall conform to Table 9.4.3.1.
- 2) *Dead loads* need not be considered in computing deflections referred to in Sentence (1).

**Table 9.4.3.1.**

**Maximum Deflections**

**Forming Part of Sentence 9.4.3.1.(1)**

Structural Members	Type of Ceiling Supported	Max. Allowable Deflection as an Expressed Ratio of the Clear Span
Roof rafters, roof joists and roof beams	No ceiling	1/180
	Other than plaster or gypsum board	1/240
	Plaster or gypsum board	1/360
Ceiling joists	Other than plaster or gypsum board	1/240
	Plaster or gypsum board	1/360
Floor beams, floor joists and floor decking	All cases	1/360
Beams, joists and decking for balconies, decks and other accessible exterior platforms	Serving a single <i>dwelling unit</i>	1/240
	Other	1/360

## 9.4.4. Foundation Conditions

### 9.4.4.1. Allowable Bearing Pressures

- 1) Footing sizes for *shallow foundations* shall be
  - a) determined in accordance with Section 9.15., or
  - b) designed in accordance with Section 4.2. using
    - i) the maximum allowable bearing pressures in Table 9.4.4.1., or
    - ii) allowable bearing pressures determined from *subsurface investigation*.

Table 9.4.4.1.

#### Allowable Bearing Pressure for Soil or Rock

##### Forming Part of Sentence 9.4.4.1.(1)

Type and Condition of Soil or Rock	Maximum Allowable Bearing Pressure, kPa
Dense or compact sand or gravel <sup>(1)</sup>	150
Loose sand or gravel <sup>(1)</sup>	50
Dense or compact silt <sup>(1)</sup>	100
Stiff clay <sup>(1)</sup>	150
Firm clay <sup>(1)</sup>	75
Soft clay <sup>(1)</sup>	40
Till	200
Clay shale	300
Sound rock	500

Notes to Table 9.4.4.1.:

<sup>(1)</sup> See Note A-Table 9.4.4.1.

### 9.4.4.2. Foundation Capacity in Weaker Soil and Rock

1) Where a *soil* or *rock* within a distance equal to twice the footing width below the *bearing surface* has a lower allowable bearing pressure than that at the *bearing surface* as shown in Article 9.4.4.1., the design capacity of the *foundation* shall not be greater than would cause the weakest *soil* or *rock* to be stressed beyond its allowable bearing pressure.

2) In calculating subsurface pressures referred to in Sentence (1), the loads from the footings shall be assumed to be distributed uniformly over a horizontal plane within a frustum extending downward from the footing at an angle of 60° to the horizontal.

### 9.4.4.3. High Water Table

1) Where a *foundation* bears on gravel, sand or silt, and the water table is within a distance below the *bearing surface* equal to the width of the *foundation*, the allowable bearing pressure shall be 50% of that determined in Article 9.4.4.1.

### 9.4.4.4. Soil Movement

1) Where a *foundation* is located in an area where *soil* movement caused by changes in *soil* moisture content, freezing, or chemical-microbiological oxidation is known to occur to the extent that it will damage a *building*, measures shall be taken to preclude such movement or to reduce

its effects on the *building* so that the *building's* stability and the performance of assemblies will not be adversely affected. (See Note A-9.4.4.4.(1).)

2) The potential for slope instability and its consequences, such as slope displacement, shall be evaluated based on site-specific material properties and ground motion parameters referenced in Subsection 1.1.3. and shall be taken into account in the design of the structure and its *foundations*.

#### **9.4.4.5. Retaining Walls**

1) Walls shall be designed to resist the lateral pressure of the retained material.

#### **9.4.4.6. Walls Supporting Drained Earth**

(See Note A-9.4.4.6. and 9.15.1.1.)

1) Except where constructed in accordance with Section 9.15., walls supporting drained earth shall be designed

a) for a pressure equivalent to that exerted by a fluid that has a density of not less than 480 kg/m<sup>3</sup> and a depth equal to that of the retained earth, or

b) in accordance with Section 4.2. so as to be able to resist the loads and effects described in Article 4.1.2.1.

2) Walls supporting other than drained earth shall be designed

a) for the pressure described in Clause (1)(a) plus the fluid pressure of the surcharge, or

b) in accordance with Section 4.2. so as to be able to resist the loads and effects described in Article 4.1.2.1.

## **Section 9.5. Design of Areas and Spaces**

### **9.5.1. General**

#### **9.5.1.1. Method of Measurement**

1) Unless otherwise indicated herein, dimensions of rooms or spaces shall be measured between finished wall surfaces and between finished floor and ceiling surfaces.

#### **9.5.1.2. Combination Rooms**

(See Note A-9.5.1.2.)

1) Two or more areas may be considered as a combination room if the opening between the areas occupies the larger of 3 m<sup>2</sup> or 40% or more of the area of the wall measured on the side of the dependent area.

2) Where the dependent area is a bedroom, direct passage shall be provided between the two areas.

### **9.5.2. Accessible Design**

#### **9.5.2.1. General**

1) Except as provided in Articles 9.5.2.3. and 3.8.2.1., every *building* shall be designed in conformance with Section 3.8.

#### **9.5.2.2. Protection on Floor Areas with an Accessible Path of Travel**

1) Where an *accessible* path of travel required in Article 9.5.2.1. is provided to any *storey* above the *first storey*, the requirements in Article 3.3.1.7. shall apply.

**9.5.2.3. Apartment Buildings**

1) Except as provided in Sentence (2), in a *building of residential occupancy* that contains multiple *dwelling units* and common interior space served by a common *building* entrance, *access* described in Section 3.8. shall be provided from the entrances, required by Sentence 3.2.1.1.(1) to be *accessible*, throughout all common spaces of entrance *storeys* and within all other common spaces including rooftop *occupancies* serving *adaptable dwelling units*.

2) *Access* required by Sentence (1) need not be provided on a floor level that

a) is not served by a ramp, passenger elevator, a platform-equipped passenger-elevating device, an escalator or an inclined moving walk,

b) is not a *building* entrance level, and

c) does not contain common facilities that are not also provided on an *accessible* level.

**9.5.2.4. Visible Signal Devices**

1) Visible signal devices shall be installed in conformance with Articles 3.2.4.19. and 3.2.4.20.

**9.5.2.5. Lighting**

1) Notwithstanding the requirements of Subsection 9.34.2., illumination shall be provided in accordance with Article 3.2.7.1.

**9.5.3. Ceiling Heights**

**9.5.3.1. Ceiling Heights of Rooms or Spaces**

1) Except as provided in Sentences (2) and (3), the ceiling heights and clear heights in rooms or spaces in *residential occupancies* shall conform to Table 9.5.3.1.

2) Reserved.

3) Reserved.

4) Areas in rooms or spaces over which ceiling height and clear height are not less than the minimum specified in Table 9.5.3.1. or Sentence (2) or (3) shall be contiguous with the entry or entries to those rooms or spaces.

**Table 9.5.3.1.**

**Room Ceiling Heights**

**Forming Part of Sentences 9.5.3.1.(1) and (4)**

Room or Space	Minimum Ceiling Height, m	Minimum Clear Height, m	Minimum Area Over Which Minimum Ceiling Height Shall Be Provided <sup>(1)</sup>
Living room or space	2.1	2.0	Lesser of area of the space or 10.0 m <sup>2</sup>
Dining room or space	2.1		Lesser of area of the space or 5.2 m <sup>2</sup>
Kitchen or kitchen space	2.1		Lesser of area of the space or 3.2 m <sup>2</sup>
Master bedroom or bedroom space	2.1		Lesser of area of the space or 4.9 m <sup>2</sup>
Other bedroom or sleeping space	2.1		Lesser of area of the space or 3.5 m <sup>2</sup>

Unfinished <i>basement</i> including laundry area therein			Clear height under beams and in any location that would normally be used for passage
Bathroom, water-closet room or laundry area above <i>grade</i>	2.1		Lesser of area of the space or 2.2 m <sup>2</sup>
Passage, hall or main entrance vestibule	2.1		Area of the space
Habitable rooms and spaces not specifically mentioned above	2.1		Lesser of area of the space or 2.2 m <sup>2</sup>

**Notes to Table 9.5.3.1.:**

<sup>(1)</sup> Area of the space shall be measured at floor level.

**9.5.3.2. Mezzanines**

1) The ceiling height above and below a *mezzanine* floor assembly in *occupancies* other than *residential occupancies* shall be not less than 2.1 m.

**9.5.3.3. Storage Garages**

1) The clear height in a *storage garage* shall be not less than 2 m.

**9.5.4. Hallways**

**9.5.4.1. Hallway Width**

1) The unobstructed width of a hallway within a *dwelling unit* shall be not less than 860 mm, except that the hallway width is permitted to be 710 mm where

- a) there are only bedrooms and bathrooms at the end of the hallway furthest from the living area, and
- b) a second *exit* is provided
  - i) in the hallway near the end farthest from the living area, or
  - ii) in each bedroom served by the hallway.

**9.5.5. Doorway Sizes**

**9.5.5.1. Doorway Opening Sizes**

1) Except as provided in Articles 9.5.5.3., 9.9.6.2. and 9.9.6.3., doorway openings within *dwelling units* and within a ~~house~~ principal *dwelling unit* with an *ancillary residential unit* including their common spaces shall be designed to accommodate at least the door sizes given in Table 9.5.5.1. for swing-type and folding doors.

2) Reserved.

**Table 9.5.5.1.**

**Size of Doors**

**Forming Part of Sentence 9.5.5.1.(1)**

At Entrance to:	Minimum Width, mm	Minimum Height, mm
<i>Dwelling unit</i> or principal <i>dwelling unit</i> with an <i>ancillary residential unit</i> including common spaces (required entrance)	810	1 980
Vestibule or entrance hall		
Stairs to a floor level that contains a finished space	810	

All doors in at least one line of passage from the exterior to the <i>basement</i>		1 980
Utility rooms		
Walk-in closet	610	1 980
Bathroom, water-closet room, shower room <sup>(1)</sup>	610	1 980
Rooms located off hallways that are permitted to be 710 mm wide	610	1 980
Rooms not mentioned above, exterior balconies	760	1 980

**Notes to Table 9.5.5.1.:**

<sup>(1)</sup> See Article 9.5.5.3.

### **9.5.5.2. Doorways to Public Water-Closet Rooms**

1) Doorways to public water-closet rooms shall be not less than 810 mm wide and 2 030 mm high.

### **9.5.5.3. Doorways to Rooms with a Bathtub, Shower or Water Closet**

(See Note A-9.5.5.3.)

1) This Article applies where a hallway of not less than 860 mm wide serves one or more rooms containing a bathtub, shower or water closet.

2) At least one doorway in a hallway described in Sentence (1) shall be constructed

a) so that access is provided to not less than 1 of each type of fixture described in Sentence (1), and

b) to accommodate a door not less than 760 mm wide.

### **9.5.6. Automatic Overhead Garage Doors**

#### **9.5.6.1. Automatic Overhead Garage Doors**

1) Automatic overhead garage doors equipped with openers shall be designed in accordance with Articles 3.3.7.6. and 3.3.7.7.

## **Section 9.6. Glass**

### **9.6.1. General**

#### **9.6.1.1. Application**

1) This Section applies to glass, and the protection of glass, in

a) doors, including closet doors and sidelights for doors,

b) windows,

c) skylights as defined in Sentence 9.7.1.1.(2),

d) shower or bathtub enclosures,

e) glazed panels and partitions, and

f) glass guards.

(See Note A-9.6.1.1.(1).)

#### **9.6.1.2. Material Standards for Glass**

1) Glass shall conform to

- a) CAN/CGSB-12.1, "Safety Glazing,"
- b) CAN/CGSB-12.2-M, "Flat, Clear Sheet Glass,"
- c) CAN/CGSB-12.3-M, "Flat, Clear Float Glass,"
- d) CAN/CGSB-12.4-M, "Heat Absorbing Glass,"
- e) CAN/CGSB-12.8, "Insulating glass units,"
- f) CAN/CGSB-12.9, "Spandrel glass,"
- g) CAN/CGSB-12.10-M, "Glass, Light and Heat Reflecting,"
- h) CAN/CGSB-12.11-M, "Wired Safety Glass," or
- i) ASTM E2190, "Standard Specification for Insulating Glass Unit Performance and Evaluation."

2) Mirrored glass doors are only permitted to be used at the entrance to clothes closets and shall conform to the requirements of CAN/CGSB-82.6-M, "Doors, Mirrored Glass, Sliding or Folding, Wardrobe." (See Note A-9.6.1.2.(2).)

**9.6.1.3. Structural Sufficiency of Glass**

- 1) Except as provided in Sentence (3), glass shall be designed in conformance with
  - a) CAN/CGSB-12.20-M, "Structural Design of Glass for Buildings," or
  - b) ASTM E1300, "Standard Practice for Determining Load Resistance of Glass in Buildings." (See also Article 4.3.6.1.)
- 2) Reserved.
- 3) Individual panes of glass conforming to Table 9.6.1.3. that are used in doors need not comply with Sentence (1).

**Table 9.6.1.3.  
Glass Area for Doors  
Forming Part of Sentence 9.6.1.3.(3)**

Glass Thickness, mm	Maximum Glass Area, m <sup>2(1)</sup>						
	Type of Glass						
	Annealed	Annealed, Multiple-Glazed, Factory-Sealed Units	Laminated	Wired	Heat-Strengthened	Fully Tempered	Fully Tempered, Multiple-Glazed, Factory-Sealed
3	0.50	0.70	(2)	(2)	1.00	1.00	2.00
4	1.00	1.50	(2)	(2)	1.50	4.00	4.00
5	1.50	1.50	(2)	(2)	1.50	No limit	No limit
6	1.50	1.50	1.20	1.00	1.50	No limit	No limit

Notes to Table 9.6.1.3.:

(1) See Note A-Table 9.6.1.3.

(2) Not generally available.

**9.6.1.4. Types of Glazing and Protection of Glazing**



- 1) Glass sidelights and windows located within 915 mm of doors, and greater than 500 mm wide that could be mistaken for doors, glass in storm doors and glass in sliding doors within or at every entrance to a *dwelling unit* and in public areas shall be
  - a) safety glazing of the tempered or laminated type conforming to CAN/CGSB-12.1, "Safety Glazing," or
  - b) wired glass conforming to CAN/CGSB-12.11-M, "Wired Safety Glass."
- 2) Except as provided in Sentence (4), glass in entrance doors to *dwelling units* and in public areas, other than the entrance doors described in Sentence (1), shall be safety glazing or wired glass of the type described in Sentence (1) where the glass area exceeds 0.5 m<sup>2</sup> and extends to less than 900 mm from the bottom of the door.
- 3) Except as provided in Sentence (4), transparent panels that could be mistaken as a *means of egress* shall be protected by barriers or railings.
- 4) Sliding glass *partitions* that separate a *public corridor* from an adjacent *occupancy* and that are open during normal working hours need not conform to Sentences (2), (3) and (5), except that such *partitions* shall be suitably marked to indicate their existence and position.
- 5) Except as provided in Sentence (4), every glass or transparent door accessible to the public shall be equipped with hardware, bars or other permanent fixtures designed so that the existence and position of such doors is readily apparent.
- 6) Glazing used for a shower or bathtub enclosure shall conform to Class A of CAN/CGSB-12.1, "Safety Glazing."
- 7) All skylights shall be glazed with wired glass, laminated safety glass or combustible glazing, which is anchored to the skylight frame and to the building structure. (See Note A-3.1.14.3.)

## **Section 9.7. Windows, Doors and Skylights**

(See Note A-9.7. and Note A-9.7.4.)

### **9.7.1. General**

#### **9.7.1.1. Application**

- 1) This Section applies to
  - a) windows, doors and skylights separating *conditioned space* from unconditioned space or the exterior, and
  - b) entrance doors to *dwelling units*.
- 2) For the purpose of this Section, the term "skylight" refers to unit skylights, roof windows and tubular daylighting devices.
- 3) For the purpose of this Section, the term "doors" includes glazing in doors and sidelights for doors but does not include vehicular access doors.

### **9.7.2. Required Windows, Doors and Skylights**

#### **9.7.2.1. Entrance Doors**

- 1) A door shall be provided at each entrance to a *dwelling unit*.
- 2) Main entrance doors to *dwelling units* shall be provided with
  - a) a door viewer or transparent glazing in the door, or

- b) a sidelight.

#### **9.7.2.2. Reserved**

### **9.7.3. Performance of Windows, Doors and Skylights**

#### **9.7.3.1. General**

- 1) Reserved
- 2) Skylights and their components shall be designed, constructed and installed so that they resist snow loads.

- 3) Reserved

- 4) Reserved

- 5) Reserved

#### **9.7.3.2. Heat Transfer Performance**

- 1) Windows, doors and skylights and their components described in Sentence 9.7.1.1.(1) shall be designed, constructed and installed to

- a) minimize surface condensation on the warm side of the component (see Note A-9.7.3.2.(1)(a)), and

- b) ensure comfortable conditions for occupants.

- 2) Compliance with the heat transfer performance requirements described in Sentence (1) shall be demonstrated by

- a) complying with the requirements in Article 9.7.3.3., or

- b) design and construction conforming to Part 5.

- 3) Windows, doors and skylights shall conform to the energy efficiency requirements of Part 10.

#### **9.7.3.3. Thermal Characteristics of Windows, Doors and Skylights**

- 1) Except as permitted in Sentence (2), metal frames and sash of windows, doors and skylights shall incorporate a thermal break.

- 2) Windows and doors described in Sentence (1) do not require a thermal break where they are installed as

- a) reserved,

- b) are installed as storm windows and doors, or

- c) are required to have a *fire-protection rating*.

- 3) Windows, doors and skylights with or without storm doors or sash that are installed in portions of *buildings* where the intended use of the interior space will result in high moisture generation shall be designed in conformance with Section 5.3. (See Note A-9.25.5.2.)

- 4) Reserved.

### **9.7.4. Design and Construction**

#### **9.7.4.1. General**

- 1) Except as provided by Sentence (2), windows, doors, skylights and their components shall be designed and constructed in accordance with

- a) Article 9.7.4.2., or
- b) Part 5.
- 2) Windows, doors, skylights and their components that are required to have a *fire-protection rating* need not conform to this Subsection.

#### **9.7.4.2. Standards**

- 1) Except as permitted by Sentence (2) and Article 9.7.4.3., windows, doors and skylights and their components shall conform to
  - a) AAMA/WDMA/CSA 101/I.S.2/A440, “North American Fenestration Standard/Specification for windows, doors, and skylights” (Harmonized Standard), and
  - b) CSA A440S1, “Canadian Supplement to AAMA/WDMA/CSA 101/I.S.2/A440-17, North American Fenestration Standard/Specification for windows, doors, and skylights,”(See Note A-9.7.4.2.(1).)
  - 2) A door designated as a “Limited Water” door in accordance with the standard referenced in Clause (1)(a) shall not be used unless the door
    - a) separates a *dwelling unit* from an unconditioned *storage garage* or a carport,
    - b) is designed with a clear width, a clear and level space, a door-opening device and a door closer in conformance with Subsection 3.8.3. (see Article 3.8.3.6.), or
    - c) meets the criteria in Sentence 9.27.3.8.(3) such that flashing would not be required.

#### **9.7.4.3. Performance Requirements**

- 1) For the purposes of compliance with the standard referenced in Clause 9.7.4.2.(1)(b), windows, doors and their components in a building of no more than 10 m in height, measured from *grade*, may conform to the design pressure, performance grade and water resistance values in Table C-5 of Appendix C instead of the values calculated in the CSA A440S1, “Canadian Supplement to AAMA/WDMA/CSA 101/I.S.2/A440, NAFS - North American Fenestration Standard/Specification for Windows, Doors, and Skylights,”
- 2) For *buildings* described in Sentence 1.3.3.3.(1) of Division A, where design pressure, performance grade and water resistance values are calculated in accordance with the standard referenced in Clause 9.7.4.2.(1)(b), the driving rain wind pressure (DRWP) values in Table A.1 of CSA A440S1, “Canadian Supplement to AAMA/WDMA/CSA 101/I.S.2/A440, NAFS - North American Fenestration Standard/Specification for Windows, Doors, and Skylights,” shall be used.

(See Note A-9.7.4.3.(2).)

- 3) Reserved
- 4) Reserved

### **9.7.5. Resistance to Forced Entry**

#### **9.7.5.1. Resistance to Forced Entry for Sliding Doors**

- 1) This Article applies to sliding doors serving *dwelling units*, other than exterior doors to garages and to other ancillary spaces.
- 2) Sliding doors shall not permit the removal of the sliding panel when in the locked position.
- 3) Exterior doors shall

- a) have a pin type locking mechanism, with a minimum 9 mm throw into the frame, or an equivalent locking mechanism, operable from the interior without the use of keys, special devices or specialized knowledge of the locking mechanism, or
- b) conform to at least Grade 10 in ASTM F842, "Standard Test Methods for Measuring the Forced Entry Resistance of Sliding Door Assemblies, Excluding Glazing Impact."

#### **9.7.5.2. Resistance to Forced Entry for Swinging Doors**

- 1) Except for exterior doors to ancillary spaces other than garages, this Article applies to
  - a) swinging entrance doors to *dwelling units*,
  - b) swinging doors between *dwelling units* and attached garages or other ancillary spaces,
  - c) swinging doors that provide access directly or indirectly from a *storage garage* to a *dwelling unit*, and
  - d) swinging entrance doors to detached storage garages ancillary to a *dwelling unit*.

(See Note A-9.7.5.2.(1).)

2) Doors, frames and hardware that conform to a security level of at least Grade 10 as described in the Annex to ASTM F476, "Standard Test Methods for Security of Swinging Door Assemblies," are not required to conform to Sentences (3) to (7). (See Note A-9.7.5.2.(2).)

- 3) Except as permitted in Sentence (2), wood doors as described in Sentence (1) shall
  - a) be solid core or stile-and-rail type,
  - b) be not less than 45 mm thick, and
  - c) if of the stile-and-rail type, have a panel thickness of not less than 19 mm, with a total panel area not more than half of the door area.

- 4) Except as permitted in Sentence (2), doors described in Sentence (1) shall be provided with
  - a) a deadbolt lock with a cylinder having no fewer than 5 pins, and
  - b) a bolt throw not less than 25 mm long, protected with a solid or hardened free-turning ring or beveled cylinder housing.

(See Article 9.9.6.7.)

5) Except as permitted in Sentence (2), an inactive leaf in double doors used in locations specified in Sentence (1) shall be provided with heavy-duty bolts top and bottom having an engagement of not less than 15 mm.

- 6) Except as permitted in Sentence (2), hinges for doors described in Sentence (1) shall be fastened
  - a) to wood doors with wood screws not less than 25 mm long and to wood frames with wood screws so that at least 2 screws per hinge penetrate not less than 30 mm into solid wood, or
  - b) to metal doors and metal frames with machine screws not smaller than No. 10 and not less than 10 mm long.

(See Note A-9.7.5.2.(6).)

7) Strikeplates for deadbolts described in Sentence (4) shall be fastened

- a) to wood frames with wood screws that penetrate not less than 30 mm into solid wood, or

b) to metal frames with machine screws not smaller than No. 8 and not less than 10 mm long.

(See Note A-9.7.5.2.(6))

8) Except for storm or screen doors, doors described in Sentence (1) that swing outward shall be provided with hinges or pins so that the doors cannot be removed when they are in the closed position. (See Note A-9.7.5.2.(8).)

9) Solid blocking shall be provided on both sides at the lock height between the jambs for doors described in Sentence (1) and the structural framing so that the jambs will resist spreading by force.

10) Except as permitted by Sentences (11) and (12), a door frame reinforcement plate shall be installed between the jack stud and door frame, and shall be:

a) constructed of minimum 18 gauge steel plate;

b) provided with an integral metal tongue that is:

i) at right angles to the plate located and designed so as to resist the inwards movement of the door when the deadbolt is engaged, and

ii) inset into the door frame to a minimum 15.9 mm depth; and

c) screwed into the door frame or adjacent jack stud with wood screws that are:

i) are not smaller than No. 10,

ii) penetrate at least 50 mm into wood studs,

iii) have at least two points of attachment on each side of the deadbolt, and

iv) are located at least 38 mm away from the deadbolt throw.

(See Notes A-9.7.5.2.(10) and (11).)

11) Except as permitted by Sentence (12), strikeplates required by Clause 9.7.5.2.(7)(a) and installed in a wood door frame without the reinforcement plate of Sentence (10), shall be:

a) constructed from minimum 18 gauge steel plate;

b) provided with an integral door reinforcement by means of a minimum 13 mm long metal tongue inset into the frame at right angles to the strike plate and arranged so as to resist forced entry when the deadbolt is engaged; and

c) attached to the door frame by means of wood screws penetrating at least 30 mm into the wood at least two points of attachment on each side of the deadbolt, at least 38 mm away from the deadbolt throw.

(See Note A-9.7.5.2.(10) and (11).)

12) A door provided with a multi-point locking system is not required to comply with Sentences (10) or (11).

### **9.7.5.3. Resistance to Forced Entry for Windows**

1) In *dwelling units*, windows, any part of which is located within 2 m of adjacent ground level, shall conform to the requirements for resistance to forced entry as described in Clause 5.3.6 of AAMA/WDMA/CSA 101/IS.2/A440, "North American Fenestration Standard/Specification for windows, doors, and skylights." (See Note A-9.7.5.3.(1).)

### **9.7.5.4. Resistance to Forced Entry for Skylights**

1) All openable skylights shall be designed to prevent opening from the outside when in the closed and locked position.

2) All exterior skylight fasteners shall be tamperproof.

### **9.7.6. Installation**

#### **9.7.6.1. Installation of Windows, Doors and Skylights**

1) Except as provided by Sentence (2), the installation of manufactured and pre-assembled windows, doors and skylights and the field assembly of manufactured window and door combination units shall conform to the instructions, if any, provided by the manufacturer.

2) In case of conflict between the provisions of this By-law and instructions referred to in Sentence (1), the provisions of this By-law shall govern.

3) Windows, doors and skylights shall be sealed to air barriers.

#### **9.7.6.2. Sealants, Trim and Flashing**

1) The sealing compound used to seal the glass component of an insulating glazing unit to the sash component shall be compatible with the sealing compound used to edge seal the glass component.

2) Flashing used to protect openings shall conform to Articles 9.27.3.7. and 9.27.3.8.

3) Sealants shall be applied between window frames or trim and the exterior cladding or masonry in conformance with Subsection 9.27.4.

4) All unfinished portions of the frame and other components of aluminum windows, doors or skylights in contact with the edges of masonry, concrete, stucco or plaster shall be protected with an alkali-resistant coating.

## **Section 9.8. Stairs, Ramps, Landings, Handrails and Guards**

### **9.8.1. Application**

#### **9.8.1.1. General**

1) This Section applies to the design and construction of interior and exterior stairs, steps, ramps, handrails and guards.

#### **9.8.1.2. Stairs, Ramps, Landings, Handrails and Guards in Garages**

1) Where stairs, ramps, landings, handrails or guards are installed in garages that serve a single dwelling unit or a principal dwelling unit with an ancillary residential unit including their common spaces, the garage shall be considered to be part of the dwelling unit and the requirements for stairs, ramps, landings, handrails and guards within dwelling units shall apply.

#### **9.8.1.3. Exit Stairs, Ramps and Landings**

1) Where a stair, ramp or landing forms part of an exit, the appropriate requirements in Sections 9.9. and 9.10. shall also apply.

#### **9.8.1.4. Escalators and Moving Walkways**

1) Escalators and moving walkways shall conform to the appropriate requirements in Part 3.

#### **9.8.1.5. Tactile Walking Surface Indicators**

1) Tactile attention indicators shall be installed in conformance with Article 3.3.1.19.

## **9.8.2. Stair Dimensions**

### **9.8.2.1. Stair Width**

1) Except as provided in Sentence (2), required *exit* stairs and public stairs serving *buildings* of *residential occupancy* shall have a width of not less than 900 mm.

2) *Exit* stairs serving a single *dwelling unit* or a single detached house including their common spaces shall have a width of not less than 860 mm.

3) Required *exit* stairs and public stairs serving *buildings* of other than *residential occupancy* shall have a width of not less than the greater of

a) 900 mm, or

b) 8 mm per person based on the *occupant load* limits specified in Table 3.1.17.1.

4) At least one stair between each floor level within a *dwelling unit*, and exterior stairs serving a single *dwelling unit* except required *exit* stairs, shall have a width of not less than 860 mm.

### **9.8.2.2. Height over Stairs**

1) The clear height over stairs shall be measured vertically, over the clear width of the stair, from a straight line tangent to the tread and landing nosings to the lowest point above. (See Note A-3.4.3.4. and Note A-9.5.3.1.)

2) Except as provided in Sentences (3), the clear height over stairs shall not be less than 2 050 mm.

3) The clear height over stairs serving a single *dwelling unit* or a single detached house shall not be less than 1 950 mm.

4) Reserved

## **9.8.3. Stair Configurations**

### **9.8.3.1. Permitted Configurations**

(See Note A-9.8.4.)

1) Except as provided by Sentence (2), stairs in *buildings* other than *dwelling units* and single detached houses, shall consist of

a) straight *flights*, or

b) except as provided in Sentence (4), curved *flights*.

2) Stairs within *dwelling units* and single detached houses, shall consist of

a) straight *flights*,

b) except as provided in Sentence (4), curved *flights*,

c) reserved,

d) except as provided in Sentence (3), *flights* with rectangular treads and winders, or

e) reserved.

3) Only one set of winders described in Article 9.8.4.6. shall be permitted between floor levels.

4) Curved *flights* in *exits* shall comply with Sentence 3.4.6.9.(2).

5) All *tapered treads* within a *flight* shall turn in the same direction.

**9.8.3.2. Minimum Number of Risers**

1) Except for stairs within a *dwelling unit*, at least 3 risers shall be provided in interior *flights*.

**9.8.3.3. Maximum Height of Stairs**

1) The vertical height of any *flight* of stairs shall not exceed 3.7 m.

**9.8.4. Step Dimensions**

(See Note A-9.8.4.)

**9.8.4.1. Dimensions for Risers**

(See Note A-9.8.4.)

1) Except for stairs serving areas only used as *service rooms* or *service spaces*, the rise, which is measured as the vertical nosing-to-nosing distance, shall comply with Table 9.8.4.1.

**Table 9.8.4.1.**

**Rise for Rectangular Treads, Tapered Treads and Winders**

**Forming Part of Sentence 9.8.4.1.(1)**

Stair Type	Rectangular Treads, <i>Tapered Treads</i> and Winders	
	Rise, mm	
	Max.	Min.
Private <sup>(1)</sup>	200	125
Public <sup>(2)</sup>	180	125

**Notes to Table 9.8.4.1.:**

<sup>(1)</sup> Private stairs are exterior and interior stairs that serve

- (a) single *dwelling units*,
- (b) single detached houses, or
- (c) garages that serve *dwelling units* described in Clause a) or b).

<sup>(2)</sup> Public stairs are all stairs not described as service stairs or private stairs.

**9.8.4.2. Dimensions for Rectangular Treads**

(See Note A-9.8.4.)

1) Except for stairs serving areas only used as *service rooms* or *service spaces*, the *run* shall comply with Table 9.8.4.2.

**Table 9.8.4.2.**

**Run for Rectangular Treads**

**Forming Part of Sentence 9.8.4.2.(1)**

Stair Type	Rectangular Treads	
	Run, mm	
	Max.	Min.
Private <sup>(1)</sup>	355	255
Public <sup>(2)</sup>	No limit	280

**Notes to Table 9.8.4.2.:**

<sup>(1)</sup> Private stairs are exterior and interior stairs that serve

- (a) single *dwelling units*,
- (b) single detached houses, or



(c) garages that serve *dwelling units* described in Clause a) or b).

<sup>(2)</sup> Public stairs are all stairs not described as service stairs or private stairs.

2) The depth of a rectangular tread shall be not less than its *run* and not more than its *run* plus 25 mm.

#### **9.8.4.3. Dimensions of Tapered Treads**

(See Note A-9.8.4.)

1) Except as provided in Sentence (3) and Article 9.8.4.6., *tapered treads* shall have a *run* that

a) is not less than 150 mm at the narrow end of the tread, and

b) complies with the dimensions stated in Table 9.8.4.2. when measured at a point 300 mm from the centre line of the handrail at the narrow end of the tread.

2) *Tapered treads* in required *exit* stairs shall conform to the requirements in Article 3.4.6.9.

3) The depth of a *tapered tread* shall be not less than its *run* at any point and not more than its *run* at any point plus 25 mm.

#### **9.8.4.4. Uniformity and Tolerances for Risers, Runs and Treads**

1) Except as provided in Sentence (2), risers shall be of uniform height in any one *flight*, with a maximum tolerance of

a) 5 mm between adjacent treads or landings, and

b) 10 mm between the tallest and shortest risers in a *flight*.

2) Except for required *exit* stairs, where the top or bottom riser in a stair adjoins a sloping finished walking surface, such as a garage floor, driveway or sidewalk, the height of the riser across the stair shall vary by not more than 1 in 12.

3) Rectangular treads shall have a uniform *run* with a maximum tolerance of

a) 5 mm between adjacent treads, and

b) 10 mm between the deepest and shallowest treads in a *flight*.

4) *Tapered treads* in a *flight* shall have a uniform *run* in accordance with the construction tolerances stipulated in Sentence (3) when measured at a point 300 mm from the centre line of the handrail as described in Sentence 9.8.7.1.(5).

5) The slope of treads shall not exceed 1 in 50.

#### **9.8.4.5. Reserved**

#### **9.8.4.6. Winders**

(See Note A-9.8.4.6.)

1) Individual treads in winders shall turn through an angle of

a) 30° with no deviation above or below 30°, or

b) 45° with no deviation above or below 45°.

2) Where winders are incorporated into a stair, each set shall not turn through more than 90°.

3) Treads in winders shall have a *run*, measured at a point 200 mm from the narrow end of the tread, conforming to the minimum *run* requirements for a private stair in Table 9.8.4.2.

#### **9.8.4.7. Reserved**

#### **9.8.4.8. Tread Nosings**

(See Notes A-9.8.4.8. and A-9.8.4.)

- 1) Except as permitted by Sentence (2), the top of the nosings of stair treads shall have a rounded or beveled edge extending not less than 6 mm and not more than 14 mm measured horizontally from the front of the nosing.
- 2) If resilient material is used to cover the nosing of a stair tread, the minimum extension of the rounded or beveled edge required by Sentence (1) is permitted to be reduced to 3 mm.

#### **9.8.4.9. Open Risers**

- 1) Except as provided in Sentence (2), stairs shall have no open risers.
- 2) Open risers are permitted in
  - a) interior and exterior stairs that serve a single *dwelling unit* or a single detached house,
  - b) fire escape stairs,
  - c) stairs that are principally used for maintenance,
  - d) stairs that serve *service rooms*, and
  - e) stairs that serve *industrial occupancies* other than *storage garages*.

#### **9.8.5. Ramps**

##### **9.8.5.1. Application**

- 1) This Subsection applies to pedestrian *ramps*, except *ramps* in an *accessible* path of travel.
- 2) *Ramps* in an *accessible* path of travel shall conform to the requirements in Article 3.8.3.5.

##### **9.8.5.2. Ramp Width**

(See also Article 9.9.3.2.)

- 1) Except as provided in Sentence (2), *ramps* shall be not less than 1 100 mm wide.
- 2) *Ramps* serving a single *dwelling unit* or a single detached house shall be not less than 860 mm wide.

##### **9.8.5.3. Height over Ramps**

- 1) Except as permitted by Sentence (2), the clear height over *ramps* shall be not less than 2 050 mm.
- 2) The clear height over *ramps* serving a single *dwelling unit* or a single detached house shall be not less than 1 950 mm.

##### **9.8.5.4. Ramp Slope**

- 1) The slope of *ramps* shall be not more than
  - a) 1 in 10 for exterior *ramps*,
  - b) 1 in 10 for interior *ramps* serving *residential occupancies*,
  - c) 1 in 6 for *industrial occupancies*, and
  - d) 1 in 8 for all other *occupancies*.

#### **9.8.6. Landings**

##### **9.8.6.1. Application**

- 1) This Subsection applies to landings, except landings for *ramps* in an *accessible* path of travel.
- 2) Landings for *ramps* in an *accessible* path of travel shall conform to the requirements in Article 3.8.3.5.
- 3) Finished floors, and ground surfaces with a slope not exceeding 1 in 50, at the top and bottom of stairs or *ramps* shall be considered as landings.

#### **9.8.6.2. Required Landings**

- 1) Except as provided in Sentences (2) to (4) and Sentence 9.9.6.6.(2), a landing shall be provided
  - a) at the top and bottom of each *flight* of interior and exterior stairs, including stairs in garages,
  - b) at the top and bottom of every *ramp* with a slope greater than 1 in 50,
  - c) where a doorway opens onto a stair or *ramp*,
  - d) where a *ramp* opens onto a stair, and
  - e) where a stair opens onto a *ramp*.
- 2) Where a door at the top of a stair within a *dwelling unit* swings away from the stair, no landing is required between the doorway and the stair. (See Note A-9.8.6.2.(2).)
- 3) A landing may be omitted at the top of an exterior *flight* serving a secondary entrance to a single *dwelling unit* or a single detached house-, provided
  - a) the stair does not contain more than 3 risers,
  - b) the principal door is a sliding door or swings away from the stair, and
  - c) only a storm or screen door, if any, swings over the stair and is equipped with hardware to hold it open.
- 4) A landing may be omitted at the bottom of an exterior stair or *ramp*, provided there is no obstruction, such as a gate or door, within the lesser of the width of the stair or *ramp* or
  - a) 900 mm for stairs or *ramps* serving a single *dwelling unit* or a single detached, and
  - b) 1 100 mm for stairs or *ramps* not described in Clause (a).

#### **9.8.6.3. Dimensions of Landings**

(See Note A-3.4.6.4.) (See also Articles 9.9.6.1. and 9.9.6.6. regarding landings in *exits*.)

- 1) Except as provided in Sentences (2) to (7), landings shall be at least as wide and as long as the width of the stair or *ramp* in which they occur.
- 2) Where the landing in a stairway or *ramp* does not turn or turns less than 90°, the length of the landing need not be more than the lesser of
  - a) the required width of the stair or *ramp*, or
  - b) 1 100 mm.
- 3) The length of a landing shall be measured perpendicular to the nosings of adjacent steps or to the end of the *ramp*, at a distance equal to half the length required in Sentence (2) from the narrow edge of the landing.

- 4) Where stair *flights* or *ramps* of different widths adjoin a single landing, the minimum width of the landing shall be
- a) where one or more of the stair or *ramp* widths do not exceed their respective required widths, not less than the greater required stair or *ramp* width, or
  - b) where all of the widths of the stairs or *ramps* exceed their respective required widths, not less than the lesser actual stair or *ramp* width.
- 5) Where a door swings toward a stair, the full arc of the swing shall be over the landing.
- 6) The slope of landings shall not exceed 1 in 50.
- 7) Where a doorway or stairway opens onto the side of a *ramp*, the landing shall extend for a distance of not less than 300 mm on either side of the doorway or stairway, except on a side abutting an end wall.

**9.8.6.4. Height over Landings**

- 1) Except as permitted by Sentence (2), the clear height over landings shall be not less than 2 050 mm.
- 2) The clear height over landings serving a single *dwelling unit* or a single detached house shall be not less than 1 950 mm.

**9.8.7. Handrails**

**9.8.7.1. Required Handrails**

- 1) Except as provided in Sentences (2) to (4), handrails shall be installed on stairs and *ramps* in accordance with Table 9.8.7.1.

**Table 9.8.7.1.**

**Number of Sides of Stair or Ramp Required to Have a Handrail  
Forming Part of Sentence 9.8.7.1.(1)**

Location of Stair or Ramp	Handrails Serving Stairs			Handrails Serving Ramps	
	Stairs < 1 100 mm Wide		Stairs ≥ 1 100 mm Wide	Ramps < 1 100 mm Wide	Ramps ≥ 1 100 mm Wide
	Straight	Curved	All	Straight or Curved	All
	Number of Sides Required to Have a Handrail				
Within a <i>dwelling unit</i> , <i>single detached house</i> or an <i>ancillary residential unit</i>	1	1	1	1	2
All other locations	1	2	2	2	2

- 2) Except where a stair or *ramp* serves not more than two *dwelling units*, at least one handrail shall be located not more than 750 mm from the natural path of travel on the stair or *ramp*. (See Note A-9.8.7.1.(2).)

- 3) Handrails are not required for stairs and *ramps* serving a single *dwelling unit* or a single detached house, where

- a) interior stairs have not more than 2 risers,

- b) exterior stairs have not more than 3 risers, or
  - c) *ramps* rise not more than 400 mm.
- 4) Only one handrail is required on exterior stairs having more than 3 risers provided such stairs serve not more than one *dwelling unit* or a single detached house.
- 5) Except for stairs with winders, where a *flight* of stairs within a *dwelling unit* or a single detached consists of *tapered treads*, or a mix of *tapered treads* and rectangular treads, one handrail shall be installed along the narrow end of the treads.

#### **9.8.7.2. Continuity of Handrails**

(See Note A-9.8.7.2.)

- 1) Except as provided in Sentence (3), required handrails shall be continuously graspable throughout the length of
- a) *ramps*, and
  - b) *flights* of stairs, from the bottom riser to the top riser.
- 2) Except for stairs or *ramps* serving a single *dwelling unit* or a single detached house, at least one required handrail shall be continuous throughout the length of the stair or *ramp*, including at the landing except where interrupted by doorways. (See Note A-3.4.6.5.(11).)
- 3) For stairs or *ramps* serving a single *dwelling unit* or a single detached house, a handrail is permitted to start from a newel post or volute installed on the bottom tread.

#### **9.8.7.3. Termination of Handrails**

- 1) Handrails shall be terminated in a manner that will not obstruct pedestrian travel or create a hazard. (See Note A-9.8.7.3.(1).)
- 2) Except for stairs and *ramps* serving only one *dwelling unit* or a single dwelling, at least one handrail at the sides of a stair or *ramp* shall extend horizontally not less than 300 mm beyond the top and bottom of each *flight* or *ramp*. (See Note A-9.8.7.3.(2).)

#### **9.8.7.4. Height of Handrails**

(See Note A-9.8.7.4.)

- 1) The height of handrails on stairs and *ramps* shall be measured vertically from the top of the handrail to
- a) a straight line drawn tangent to the tread nosings of the stair served by the handrail, or
  - b) the surface of the *ramp*, floor or landing served by the handrail.
- 2) Except as provided in Sentence (3) and Clause 3.8.3.5.(1)(e), required handrails shall be 865 mm to 1 070 mm high.
- 3) Handrails installed in addition to required handrails need not comply with Sentence (2).

#### **9.8.7.5. Ergonomic Design**

- 1) The clearance between a handrail and the surface behind it shall be not less than
- a) 50 mm, or
  - b) where said surface is rough or abrasive, 60 mm.
- 2) All handrails shall be constructed so as to be continually graspable along their entire length with no obstruction on or above them to break a handhold. (See Note A-9.8.7.5.(2).)

#### **9.8.7.6. Projections into Stairs and Ramps**

1) Handrails and constructions below handrails, including handrail supports and stair stringers, shall not project more than 100 mm into the required width of a stair or *ramp* (See note A-9.8.7.6.(1)) (See also Articles 9.8.2.1. and 9.8.5.2.).

#### **9.8.7.7. Design and Attachment of Handrails**

(See Note A-9.8.7.7.)

1) Handrails and their supports shall be designed and constructed to withstand the following loads, which need not be considered to act simultaneously:

a) a concentrated load of not less than 0.9 kN applied at any point and in any direction for all handrails, and

b) for handrails other than those serving a single *dwelling unit*, a uniform load of not less than 0.7 kN/m.

2) Where exterior or interior handrails serving a single *dwelling unit* or a single detached house are attached to wood studs or blocking, the attachment shall be deemed to comply with Sentence (1), where

a) the attachment points are spaced not more than 1.2 m apart measured on the horizontal plane,

b) the first attachment point at either end is located no more than 300 mm from the end of the handrail, and

c) the fasteners consist of not less than 2 No. 8 wood screws at each point, penetrating not less than 32 mm into solid wood.

#### **9.8.8. Guards**

##### **9.8.8.1. Required Guards**

(See Note A-9.8.8.1.)

1) Except as provided in Sentence (2) and except at the leading edge at the top of a *flight*, every surface to which access is provided, including but not limited to *flights* of steps and *ramps*, exterior landings, porches, balconies, *mezzanines*, galleries and raised *walkways*, shall be protected by a *guard* on each side that is not protected by a wall for the length where the difference in elevation is more than 600 mm between the walking surface and the adjacent surface within 1.2 m.

2) *Guards* are not required

a) at loading docks,

b) at floor pits in *repair garages*, or

c) where access is provided for maintenance purposes only.

3) Doors in *buildings* of *residential occupancy*, where the finished floor on one side of the door is more than 600 mm above the floor or other constructed surface or ground level on the other side of the door, shall be protected by

a) a *guard*, or

b) a mechanism capable of controlling the free swinging or sliding of the door so as to limit any clear unobstructed opening to not more than 100 mm.

4) Except as provided in Sentence (5), openable windows in *buildings of residential occupancy* shall be protected by

a) a *guard*, or

b) a mechanism that can only be released with the use of tools or special knowledge to control the free swinging or sliding operation of the openable part of the window so as to limit any clear unobstructed opening to not more than 100 mm measured either vertically or horizontally.

(See Note A-9.8.8.1.(4).)

5) Windows need not be protected in accordance with Sentence (4), where the bottom edge of the openable portion of the window is located

a) more than 900 mm above the finished floor, or

b) less than 1 800 mm above the floor or ground on the other side of the window.

(See Note A-9.8.8.1.(4).)

6) Except as provided in Sentence (7), glazing installed over stairs, *ramps* and landings that extends to less than 1 070 mm above the surface of the treads, *ramp* or landing shall be

a) protected by *guards*, in accordance with this Subsection, or

b) non-openable and designed to withstand the specified lateral loads for balcony *guards* as provided in Article 4.1.5.14.

7) In *dwelling units* and single detached houses, glazing installed over stairs, *ramps* and landings that extends to less than 900 mm above the surface of the treads, *ramp* or landing shall be

a) protected by *guards*, in accordance with this Subsection, or

b) non-openable and designed to withstand the specified lateral loads for balcony *guards* as provided in Article 4.1.5.14.

8) Glazing installed in public areas that extends to less than 1 m from the floor and is located above the second *storey* in *buildings of residential occupancy* shall be

a) protected by *guards* in accordance with this Subsection, or

b) non-openable and designed to withstand the specified lateral loads for balcony *guards* as provided in Article 4.1.5.14.

9) Swimming pools greater than 450 mm deep shall be enclosed within a sturdy fence no less than 1.5 ~~1.22~~ m in height, with no openings in it greater than 100 mm, and with no member, attachment, or opening located between 100 mm and 900 mm above ground level which could facilitate climbing, except that heavy gauge chain link fencing with a maximum opening size of 35 mm square may be considered *acceptable* fencing for this purpose. (See Note A-9.8.8.1.(9) and (10).)

10) The fence described in Sentence (9)

a) shall enclose the pool and the principle *building* on the premises, except that the fence may enclose the pool separately if the pool is entirely visible from the principle *building* or through the fence, and

b) shall be continuous, except for points of access which shall be equipped with a self-closing gate, secured by a spring lock located no less than 1 070 mm above grade, and only openable from the pool side of the fence.

### 9.8.8.2. Loads on Guards

(See Note A-9.8.8.2.)

1) Except as provided in Sentences (2), (3) and (5), *guards* shall be designed to resist the specified loads prescribed in Table 9.8.8.2.

**Table 9.8.8.2.**  
**Specified Loads for Guards**  
**Forming Part of Sentence 9.8.8.2.(1)**

Location of <i>Guard</i>	Minimum Specified Loads		
	Horizontal Load Applied Inward or Outward at any Point at the Minimum Required Height of the <i>Guard</i>	Horizontal Load Applied Outward on Elements Within the <i>Guard</i> , Including Solid Panels and Balusters	Evenly Distributed Vertical Load Applied at the Top of the <i>Guard</i>
<i>Guards</i> within <i>dwelling units</i> and exterior <i>guards</i> serving not more than two <i>dwelling units</i>	0.5 kN/m OR concentrated load of 1.0 kN applied at any point <sup>(1)</sup>	0.5 kN applied over a maximum width of 300 mm and a height of 300 mm <sup>(2)</sup>	1.5 kN/m
<i>Guards</i> serving access ways to equipment platforms and similar areas where the gathering of many people is improbable	Concentrated load of 1.0 kN applied at any point	Concentrated load of 0.5 kN applied over an area of 100 mm by 100 mm located at any point on the element or elements so as to produce the most critical effect	1.5 kN/m
All other <i>guards</i>	0.75 kN/m OR concentrated load of 1.0 kN applied at any point <sup>(1)</sup>	Concentrated load of 0.5 kN applied over an area of 100 mm by 100 mm located at any point on the element or elements so as to produce the most critical effect	1.5 kN/m

**Notes to Table 9.8.8.2.:**

<sup>(1)</sup> The load that creates the most critical condition shall apply.

<sup>(2)</sup> See Sentence (3).

2) The size of the opening between any two adjacent vertical elements within a *guard* shall not exceed the limits required by Sentence 9.8.8.5.(1) when each of these elements is subjected to a specified *live load* of 0.1 kN applied in opposite directions in the in-plane direction of the *guard* so as to produce the most critical effect.

3) For *guards* within *dwelling units* and within principal *dwelling units* with an *ancillary residential unit* including their common spaces and for exterior *guards* serving not more than two *dwelling units*, where the width and spacing of balusters are such that three balusters can be engaged by a load imposed over a 300 mm width, the load shall be imposed so as to engage three balusters.

4) None of the loads specified in Table 9.8.8.2. need be considered to act simultaneously.

5) For *guards* within *dwelling units* and within single detached houses and for exterior *guards* serving not more than two *dwelling units*, Table 9.8.8.2. need not apply where the *guard* construction used has been demonstrated to provide effective performance.

### 9.8.8.3. Height of Guards

(See Note A-9.8.8.3.)



- 1) Except as provided in Sentences (2) and (3), all *guards* shall be not less than 1 070 mm high.
- 2) All *guards* within *dwelling units* or within single detached houses shall be not less than 900 mm high.
- 3) Exterior *guards* serving not more than one *dwelling unit* or a single detached house shall be not less than 900 mm high where the walking surface served by the *guard* is not more than 1 800 mm above the finished ground level.
- 4) The height of *guards* for *flights* of steps shall be measured vertically from the top of the *guard* to a line drawn through the tread nosing served by the *guard*.

#### **9.8.8.4. Guards for Floors and Ramps in Garages**

- 1) Except for floors of garages referred to in Section 9.35., where garage floors or ramps are 600 mm or more above the adjacent ground or floor level, every opening through a garage floor and the perimeter of floors and ramps that have no exterior walls shall be provided with
  - a) a continuous curb not less than 140 mm in height, and
  - b) a *guard* not less than 1 070 mm above the floor level.
- 2) Vehicle guardrails shall be designed and constructed to withstand the loading values stipulated in Sentence 4.1.5.15.(1). (See Note A-4.1.5.14. and 4.1.5.15.(1).)

#### **9.8.8.5. Openings in Guards**

- 1) Except as permitted in Sentences (3) and (4), openings through *guards* shall be of a size that prevents the passage of a spherical object having a diameter of 100 mm. (See Note A-9.8.8.5.(1) and (3).)
- 2) Except for *guards* that serve *industrial occupancies*, the triangular openings formed by stair risers, stair treads and the bottom element of a required *guard* shall be of a size that prevents the passage of a 150 mm diam sphere.
- 3) Except where they serve *storage garages*, *guards* in *industrial occupancies* are permitted to consist of
  - a) a top railing, and
  - b) one or more horizontal intermediate rails spaced such that the size of the openings through the *guard* prevents the passage of a spherical object having a diameter of 535 mm.(See Note A-9.8.8.5.(1) and (3).)
- 4) Openings through any *guard* that is not required by Article 9.8.8.1. and that serves an *occupancy* other than an *industrial occupancy* shall be of a size that
  - a) prevents the passage of a spherical object having a diameter of 100 mm, or
  - b) permits the passage of a spherical object having a diameter of 200 mm.(See Note A-9.8.8.5.(4).)

#### **9.8.8.6. Design of Guards to Not Facilitate Climbing**

- 1) Except for *guards* in *industrial occupancies*, *guards* required by Article 9.8.8.1. that protect a level located more than 4.2 m above the adjacent level shall be designed so that no member, attachment or opening located between 140 mm and 900 mm above the level protected by the *guard* facilitates climbing. (See Note A-9.8.8.6.(1).)

#### **9.8.8.7. Glass in Guards**

- 1) Glass in *guards* shall be
  - a) safety glazing of the laminated or tempered type conforming to CAN/CGSB-12.1, "Safety Glazing," or
  - b) wired glass conforming to CAN/CGSB-12.11-M, "Wired Safety Glass."

#### **9.8.8.8. Glass Guards**

1) All glass guards shall have a top rail capable of transferring the guard loads to adjacent glass panels or, in the event of the failure of a glass panel, to the structural component of the *building*.

### **9.8.9. Construction**

#### **9.8.9.1. Loads on Stairs and Ramps**

- 1) Except as specified in Articles 9.8.9.4. and 9.8.9.5., stairs and *ramps* shall be designed for strength and rigidity under uniform loading criteria to support specified loads of
  - a) 1.9 kPa for stairs and *ramps* serving not more than one *dwelling unit* or a single detached house, and
  - b) 4.8 kPa for other stairs and *ramps*.

#### **9.8.9.2. Exterior Concrete Stairs**

- 1) Exterior concrete stairs with more than 2 risers and 2 treads shall be
  - a) supported on unit masonry or concrete walls or piers not less than 150 mm in cross section, or
  - b) cantilevered from the main *foundation wall*.
- 2) Stairs described in Sentence (1), when cantilevered from the *foundation wall*, shall be constructed and installed in conformance with Subsection 9.8.10.
- 3) The depth below ground level for *foundations* for exterior steps shall conform to the requirements in Section 9.12.

#### **9.8.9.3. Exterior Wood Steps**

1) Exterior wood steps shall not be in direct contact with the ground unless suitably treated with a wood preservative.

#### **9.8.9.4. Wooden Stair Stringers**

- 1) Wooden stair stringers shall
  - a) have a minimum effective depth of 90 mm, measured perpendicularly to the bottom of the stringer at the point of minimum cross-section, and an overall depth of not less than 235 mm,
  - b) be supported and secured top and bottom,
  - c) be not less than 25 mm actual thickness if supported along their length and 38 mm actual thickness if unsupported along their length, and
  - d) except as permitted in Sentence (2), be spaced not more than 900 mm o.c. in stairs serving not more than one *dwelling unit* or a single detached-house, and 600 mm o.c. in other stairs.
- 2) For stairs serving not more than one *dwelling unit* or a single detached-house, where risers support the front portion of the tread, the space between stringers shall be not more than 1 200 mm.

#### **9.8.9.5. Treads**

1) Stair treads of lumber, plywood or OSB within *dwelling units* shall be not less than 25 mm actual thickness, except that, where open risers are permitted and the distance between stringers exceeds 750 mm, the treads shall be not less than 38 mm actual thickness.

2) Stair treads of plywood or OSB that are not continuously supported by the riser shall have their face grain or direction of face orientation at right angles to the stringers.

#### **9.8.9.6. Finish for Treads and Landings**

1) The finish for treads and landings of interior stairs in *dwelling units*, other than stairs to unfinished *basements*, shall consist of hardwood, vertical grain softwood, resilient flooring or other material providing equivalent performance.

2) Treads and landings of interior and exterior stairs and *ramps*, other than those within *dwelling units* or within houses with a *secondary suite* including their common spaces, shall have a slip-resistant finish or be provided with slip-resistant strips that extend not more than 1 mm above the surface.

### **9.8.10. Cantilevered Precast Concrete Steps**

#### **9.8.10.1. Design**

1) Exterior concrete steps and their anchorage system that are cantilevered from a *foundation* wall shall be designed and installed to support the loads to which they may be subjected.

#### **9.8.10.2. Anchorage**

1) Cantilevered concrete steps referred to in Article 9.8.10.1. shall be anchored to concrete *foundation* walls not less than 200 mm thick.

#### **9.8.10.3. Prevention of Damage Due to Frost**

1) Suitable precautions shall be taken during backfilling and grading operations to ensure that subsequent freezing of the *soil* will not cause uplift forces on the underside of cantilevered concrete steps to the extent that the steps or the walls to which they are attached will be damaged.

## **Section 9.9. Means of Egress**

### **9.9.1. General**

#### **9.9.1.1. Application**

1) Stairways, handrails and *guards* in a *means of egress* shall conform to the requirements in Section 9.8. as well as to the requirements in this Section.

#### **9.9.1.2. Fire Protection**

1) In addition to the fire protection requirements provided in Subsection 9.9.4., *flame-spread ratings*, *fire-resistance ratings* and *fire-protection ratings* for *means of egress* shall conform to Section 9.10.

#### **9.9.1.3. Occupant Load**

1) Except for *dwelling units*, the *occupant load* of a *floor area* or part of a *floor area* shall be the number of persons for which such areas are designed, but not fewer than that determined from Table 3.1.17.1., unless it can be shown that the area will be occupied by fewer persons.

2) The *occupant load* for *dwelling units* shall be based on 2 persons per bedroom or sleeping area.

## **9.9.2. Types and Purpose of Exits**

### **9.9.2.1. Types of Exits**

1) Except as otherwise provided in this Section, an *exit* from any *floor area* shall be one of the following used singly or in combination:

- a) an exterior doorway,
- b) an exterior passageway,
- c) an exterior *ramp*,
- d) an exterior stairway,
- e) a fire escape,
- f) a *horizontal exit*,
- g) an interior passageway,
- h) an interior *ramp*, or
- i) an interior stairway.

2) Fire escapes shall only be used as *exits* on existing *buildings* and shall be designed and installed in conformance with Subsection 3.4.7.

3) Where a *horizontal exit* is used, it shall conform to Sentence 3.4.1.6.(1) and Article 3.4.6.10.

### **9.9.2.2. Purpose of Exits**

1) An *exit* shall be designed for no purpose other than for exiting except that an *exit* may also serve as an access to a *floor area*.

### **9.9.2.3. Elevators, Slide Escapes and Windows as Means of Egress**

1) Elevators, slide escapes and windows shall not be considered as part of a required *means of egress*.

### **9.9.2.4. Principal Entrances**

1) Except for doors serving a single *dwelling unit* or a single detached house including their common spaces, at least one door at every principal entrance to a *building* providing access from the exterior at ground level shall be designed in accordance with the requirements for *exits*.

## **9.9.3. Dimensions of Means of Egress**

### **9.9.3.1. Application**

1) Except as required by Sentences 9.9.3.3.(2) and 9.9.3.4.(3), this Subsection applies to every *means of egress* except

- a) *exits* that serve not more than one *dwelling unit* or a single detached house, and
- b) *access to exits* within *dwelling units* and within single detached houses.

### **9.9.3.2. Exit Width**

1) Except for doors and corridors, the width of every *exit* facility shall be not less than 900 mm. (See Article 9.9.6.3. for doors, Article 9.8.2.1. for stairs, and Article 9.8.5.2. for *ramps*.)

### **9.9.3.3. Width of Corridors**

1) The width of every *public corridor*, corridor used by the public, and *exit* corridor shall be not less than 1 100 mm. (See also Subsection 9.9.5. for obstructions in corridors.)

2) The width of *public corridors* and *exit corridors* that serve a single detached house shall be not less than 860 mm.

#### **9.9.3.4. Clear Height**

1) Except for stairways, doorways and *storage garages*, the minimum clear height in *exits* and *access to exits* shall be 2.1 m. (See Article 9.8.2.2. for stairs, Article 9.8.5.3. for *ramps*, Article 9.8.6.4. for landings and Article 9.9.6.2. for doorways.)

2) The clear height in *exits* and *access to exits* in *storage garages* shall be not less than 2 m.

3) The clear height in *public corridors* and *exit corridors* that serve a single detached house shall be not less than 2 m.

### **9.9.4. Fire Protection of Exits**

#### **9.9.4.1. Application**

1) Except as provided in Articles 9.9.4.4. and 9.9.4.6., this Subsection applies to the fire protection of all *exits* except *exits* serving not more than one *dwelling unit*.

#### **9.9.4.2. Fire Separations for Exits**

1) Except as provided in Sentences (2) and (5) and Article 9.9.8.5., every *exit* other than an exterior doorway shall be separated from each adjacent *floor area* or from another *exit*

a) where there is a floor assembly above the *floor area*, by a *fire separation* having a *fire-resistance rating* not less than that required for the floor assembly above the *floor area* (see Article 9.10.9.12.), and

b) where there is no floor assembly above the *floor area*, by a *fire separation* having a *fire-resistance rating* not less than the greater of

i) that required by Subsection 9.10.8. for the floor assembly below, or

ii) 45 min.

2) Where an *exit* is located in a single detached house, the *exit* shall be separated from adjacent *floor areas* with a *fire separation*

a) having a *fire-resistance rating* not less than 15 min where all *smoke alarms* within the house are of photo-electric type and interconnected as described in Clause 9.10.19.5.(2)(a),

b) having a *fire-resistance rating* not less than 30 min where additional *smoke alarms* of photo-electric type are installed and interconnected as described in Clause 9.10.19.5.(2)(b),

c) having a *fire-resistance rating* not less than 45 min when *smoke alarms* are not installed and interconnected as described in Clauses (a) or (b), or

d) that is not required to have a *fire-resistance rating* if the *building* is *sprinklered*.

3) A *fire separation* common to 2 *exits* shall be smoke-tight and not be pierced by doorways, duct work, piping or any other opening that may affect the continuity of the separation.

4) A *fire separation* that separates an *exit* from the remainder of the *building* shall have no openings except those for electrical wiring, *noncombustible* conduit and *noncombustible* piping that serve only the *exit*, and for standpipes, sprinkler piping, *exit* doorways and wired glass and glass block permitted in Article 9.9.4.3.

5) The requirements in Sentences (1) and (2) do not apply to an exterior *exit* passageway provided the passageway has not less than 50% of its exterior sides open to the outdoors and is served by an *exit* stair at each end of the passageway.

### **9.9.4.3. Protection of Exit Facilities**

(See Note A-3.1.8.19.(1).)

1) This Article applies to

a) wired glass in doors, and wired glass or glass block in sidelights, where these are installed in *fire separations* between *exit* enclosures and *floor areas*, and

b) opening protection required by Articles 9.9.4.4. through 9.9.4.6.

2) Except as provided in Sentence (3), the combined area of glazing in doors and sidelights referred to in Clause (1)(a) shall not exceed 0.8 m<sup>2</sup>.

3) Where an *exit* enclosure connects with a *floor area* through an enclosed vestibule or corridor separated from the *floor area* by *fire separations* having not less than a 45 min *fire-resistance rating*, the glazed areas described in Clause (1)(a) need not be limited as required in Sentence (2).

4) Exterior exposing openings requiring protection by Articles 9.9.4.4. through 9.9.4.6. shall be protected with

a) wired glass in fixed steel frames or glass block conforming to Articles 9.10.13.5. and 9.10.13.7.,

b) a closure conforming with Article 9.10.13.1., or

c) a dedicated sprinkler water curtain in accordance with Article 3.2.3.13.(5).

### **9.9.4.4. Openings Near Unenclosed Exterior Exit Stairs and Ramps**

1) Except as permitted by Sentence (2), *unprotected openings* in exterior walls of the *building* shall be protected in accordance with Sentence 9.9.4.3.(4) where

a) an unenclosed exterior *exit* stair or *ramp* provides the only *means of egress* from a *suite* and is exposed to fire from *unprotected openings* in the exterior walls of

i) another *fire compartment*, or

ii) another *dwelling unit*, ancillary space or common space in a single detached house, and

b) *unprotected openings* in the exterior walls of the *building* are within 3 m horizontally and less than 10 m below or less than 5 m above the *exit* stair or *ramp*.

2) A *sprinklered* single detached house or duplex with not more than two *dwelling units* and provided with more than one path of travel from each *dwelling unit* conforming to the dimensional requirements of Article 9.10.20.3., need not be provided with the opening protection referred to in Sentence (1).

### **9.9.4.5. Openings in Exterior Walls of Exits**

1) Except as permitted by Sentence (2), either openings in exterior walls of an *exit* or openings in adjacent exterior walls of the *building* the *exit* serves shall be protected in accordance with Sentence 9.9.4.3.(4) where

a) the *exit* enclosure has exterior walls that intersect the exterior walls of the *building* at an angle of less than 135° measured on the outside of the *building*, and

b) the openings in the exterior walls of the *building* are within 3 m horizontally and less than 2 m above the openings in the exterior walls of the *exit*.

(See Note A-9.9.4.5.(1).)

2) In a *sprinklered* single detached house with not more than 2 *dwelling units*, the opening protection referred to in Sentence (1) need only be provided where a single confined path of travel provides the sole means of egress.

#### **9.9.4.6. Openings Near Exit Doors**

1) Except as permitted by Sentence (2), where an exterior *exit* door in one *fire compartment* is within 3 m horizontally of an *unprotected opening* in another *fire compartment* and the exterior walls of these *fire compartments* intersect at an exterior angle of less than 135°, the opening shall be protected in accordance with Sentence 9.9.4.3.(4)

2) A *sprinklered* single detached house or duplex with not more than 2 *dwelling units* and provided with more than one path of travel from each dwelling unit conforming to the dimensional requirements of Article 9.10.20.3., need not be provided with the opening protection referred to in Sentence (1).

#### **9.9.4.7. Stairways in 2 Storey, Group D or E Buildings**

1) Where a *suite* of Group D or E *occupancy* is located partly on the *first storey* and partly on the second *storey*, stairways serving the second *storey* of that *suite* need not be constructed as *exit* stairs provided,

- a) the *building* is not greater than 2 *storeys* in *building height*,
- b) the *suite* is separated from other *occupancies* by at least a 45 min *fire separation*,
- c) the area occupied by the *suite* is not greater than 100 m<sup>2</sup> per *storey*,
- d) the maximum travel distance from any point in the *suite* to an exterior *exit* is not greater than 25 m,
- e) the floor assemblies have a *fire-resistance rating* of not less than 45 min or are of *noncombustible construction*, and
- f) the *basement* and *first storey* are separated by a *fire separation* having a *fire-resistance rating* of not less than 45 min.

### **9.9.5. Obstructions and Hazards in Means of Egress**

#### **9.9.5.1. Application**

1) This Subsection applies to obstructions and hazards in every *means of egress* except those within a *dwelling unit* or serving not more than one *dwelling unit*.

#### **9.9.5.2. Occupancies in Corridors**

1) Where a corridor contains an *occupancy*, the *occupancy* shall not reduce the unobstructed width of the corridor to less than the required width of the corridor.

#### **9.9.5.3. Obstructions in Public Corridors**

1) Except as permitted in Sentence (2), obstructions located within 1 980 mm of the floor shall not project horizontally more than 100 mm into *exit* passageways, corridors used by the public or *public corridors* in a manner that would create a hazard for visually impaired persons travelling adjacent to walls.

2) The horizontal projection of an obstruction referred to in Sentence (1) is permitted to exceed 100 mm where the obstruction extends to less than 680 mm above the floor. (See Note A-3.3.1.8.(2) and (3).)

#### **9.9.5.4. Obstructions in Exits**

1) Except as permitted in Subsection 9.9.6. and Article 9.8.7.6., no fixture, turnstile or construction shall project within the required width of an *exit*.

#### **9.9.5.5. Obstructions in Means of Egress**

1) No obstructions such as posts or turnstiles shall be placed so as to restrict the width of a required *means of egress* from a *floor area* or part of a *floor area* to less than 750 mm unless an alternate unobstructed *means of egress* is provided adjacent to and plainly visible from the restricted egress.

2) Except as provided in Sentence (3), no obstructions, such as counter gates, that do not meet the requirements for *exit* doors, shall be placed in a required *means of egress* from a *floor area* or part of a *floor area* unless an alternate unobstructed *means of egress* is provided adjacent to and plainly visible from the restricted egress.

3) Obstructions, such as counter gates, that do not satisfy Sentence (2), are permitted to be placed in a required *means of egress* from a part of a *floor area* in *mercantile occupancies* and *business and personal services occupancies*, provided that the part of the *floor area* served by the obstructed *means of egress* is not generally accessible to the public.

#### **9.9.5.6. Mirrors or Draperies**

1) No mirror shall be placed in or adjacent to any *exit* so as to confuse the direction of *exit*, and no mirror or draperies shall be placed on or over *exit* doors.

#### **9.9.5.7. Fuel-Fired Appliances**

1) Fuel-fired *appliances* shall not be installed in an *exit* or corridor serving as an *access to exit*.

#### **9.9.5.8. Service Rooms**

1) *Service rooms* containing equipment subject to possible explosion, such as *boilers* designed to operate at a pressure in excess of 100 kPa, and certain types of refrigerating and transformer equipment, shall not be located under required *exits*.

#### **9.9.5.9. Ancillary Rooms**

1) Ancillary rooms such as storage rooms, washrooms, toilet rooms, laundry rooms and *service rooms* shall not open directly into an *exit*.

### **9.9.6. Doors in a Means of Egress**

#### **9.9.6.1. Obstructions by Doors**

1) Except as provided in Sentence (4), obstructions created by doors shall be limited in accordance with Sentences (2) and (3)

- a) at *exit* doors,
- b) at doors that open into or are located within a *public corridor*, and
- c) at doors that open into or are located within another facility that provides *access to exit* from a *suite*.

2) When fully open, doors described in Sentence (1) shall not decrease the required *exit* width by more than

- a) 100 mm in *exit* corridors, and
- b) 50 mm for other *exit* facilities.

3) The swing of doors described in Sentence (1) shall not reduce the width of the path of travel to less than



- a) the required *exit* width in *exit* corridors and passageways, and
- b) 750 mm on *exit* stairs or landings.
- 4) Doors serving a single *dwelling unit* need not comply with Sentences (2) and (3).

#### **9.9.6.2. Clear Opening Height at Doorways**

1) Except as provided in Sentences (2) and (3), the clear opening height of doorways shall be not less than 2 030 mm high at

- a) *exit* doors,
- b) doors that open into or are located within a *public corridor*, and
- c) doors that open into or are located within another facility that provides *access to exit* from a *suite*.

2) The clear opening height under door closers and other devices in doorways described in Sentence (1) shall be not less than 1 980 mm.

3) Doorways serving only a single *dwelling unit* or single detached house need not comply with Sentences (1) and (2). (See also Article 9.5.5.1.)

4) Except as permitted by Sentence (3), the clear opening height of doorways described in Sentence (1) serving a single detached house shall be not less than 1 980 mm high.

#### **9.9.6.3. Clear Opening Width at Doorways**

1) Except as provided in Sentence (4), the clear opening width of doorways shall comply with Sentence (2) at

- a) *exit* doors, and
- b) doors that open into or are located within a *public corridor* or other facility that provides *access to exit* from a *suite*.

2) Doorways described in Sentence (1) shall be

- a) not less than 850 mm wide where there is only one door leaf,
- b) not less than 850 mm wide where multiple-leaf doors are installed with only one active leaf having a latching mechanism described in Article 9.9.6.7., and
- c) not less than 1 210 mm wide where multiple-leaf doors are installed with two active leaves.

3) In doorways described in Sentence (1) that have multiple-leaf doors installed,

- a) no active leaf shall be less than 850 mm wide where only one leaf is active, and
- b) no single leaf shall be less than 610 mm wide where two leaves are active.

4) Doorways serving a single *dwelling unit* or *ancillary residential unit* including their common spaces, need not comply with Sentence (2). (See also Article 9.5.5.1.)

#### **9.9.6.4. Door Action**

1) Except as provided in Sentences (4) and (5), required *exit* doors and doors in required *means of egress*, except doors in *means of egress* within *dwelling units*, shall swing on the vertical axis.

2) Except as provided in Sentence (5), breakaway sliding doors, installed as required *exit* doors or required doors in *means of egress*, shall be identified as swinging doors by means of a label or decal affixed to the door.

3) Revolving doors shall comply with Article 3.4.6.15.

4) Movable *partitions* used to separate a *public corridor* from an adjacent *business and personal services occupancy* or a *mercantile occupancy* need not conform to Sentence (1), provided the partitions are not located in the only *means of egress*. (See Note A-3.3.1.12.(3).)

5) *Exit* doors need not conform to Sentence (1) or (2), where

a) the doors serve accessory *buildings* where life safety is not adversely affected,

b) the doors serve *storage garages* or other accessory *buildings* serving not more than one *dwelling unit*, or

c) the doors

i) serve storage *suites* of not more than 28 m<sup>2</sup> in gross area that are in warehousing *buildings* of not more than one *storey*, and

ii) open directly to the exterior at ground level.

**6)** Garage doors intended for vehicular access shall not be used a *means of egress* from a storage garage except where *acceptable* to the *Chief Building Official* and

a) designed to swing on a vertical axis in the direction of egress travel, and

b) comply with the requirements of Articles 9.9.6.7. and 9.9.6.8.

(See Note A-9.9.6.4.(6))

#### **9.9.6.5. Direction of Door Swing**

1) Except for doors serving a single *dwelling unit* or *ancillary residential unit* including their common spaces, *exit* doors that are required to swing shall swing in the direction of *exit* travel.

2) Doors that open onto a corridor or other facility that provides *access to exit* from a room or *suite* having an *occupant load* of more than 60 persons shall swing on the vertical axis in the direction of *exit* travel.

3) Doors that divide a corridor that is not wholly contained within a *suite* shall swing in the direction of *exit* travel.

4) Where a pair of doors is installed in a corridor that provides *access to exit* in both directions, the doors shall

a) swing in opposite directions, with the door on the right-hand side swinging in the direction of *exit* travel, or

b) swing in both directions.

5) Principal entrance doors opening to an *acceptable* open space at ground level are not required to swing in the direction of *exit* travel provided

a) the room or *suite* is located at ground level, and

b) the *occupant load* is not more than 60 persons.

#### **9.9.6.6. Nearness of Doors to Stairs**

1) Except as provided in Sentence (2), the distance between a stair riser and the leading edge of a door during its swing, except for doors serving a single *dwelling unit* or *ancillary residential unit* including their common spaces, shall be not less than 300 mm.

2) Where there is a danger of blockage from ice or snow, an *exit door*, including doors serving a single *dwelling unit*, may open onto not more than one step, provided the riser of such a step does not exceed 150 mm.

#### **9.9.6.7. Door Latching, Locking and Opening Mechanisms**

1) Principal entrance doors, *exit doors* and doors to *suites*, including exterior doors of *dwelling units*, and other doors in an *access to exit* shall

a) be openable from the inside or in travelling to an *exit* without requiring keys, special devices or specialized knowledge of the door-opening mechanism, or

b) be controlled by electromagnetic locking mechanisms in accordance with Sentence 3.4.6.16.(5).

2) Except for doors serving a single *dwelling unit* or a single detached house, and doors to accessory *buildings* and to garages serving a single *dwelling unit*, door release hardware on doors in a *means of egress* shall be operable with one hand and the door shall be openable with not more than one releasing operation. (See also Sentence 3.8.3.6.(4) and Note A-3.3.1.13.(4).)

3) Door release hardware on doors in a *means of egress* shall be installed 900 mm to 1 100 mm above the finished floor.

4) Except for hotels and motels, a door opening onto a *public corridor* that provides *access to exit* from *suites* shall be designed not to lock automatically if it is equipped with an automatic self-closing device. (See Note A-3.3.4.5.(1).)

#### **9.9.6.8. Effort Required to Open**

1) Every *exit door*, except doors serving a single *dwelling unit* or a single detached house, shall be designed and installed so that when the latch is released the door will open in the direction of *exit* travel under a force of not more than 90 N applied to the door release hardware. (See Sentence 3.8.3.6.(8) for door opening forces in an *accessible* path of travel.)

### **9.9.7. Access to Exits**

#### **9.9.7.1. Egress from Roof Area, Podiums, Terraces, Platforms and Contained Open Spaces**

1) Except as required by Sentences (2) and (4) an *access to exit* shall be provided from every roof intended for *occupancy* and from every podium, terrace, platform or contained open space.

2) Where a roof is intended for an *occupant load* of more than 60 persons, at least 2 separate *means of egress* at the roof level, designed in conformance with the requirements for *exits* and located remote from each other, shall be provided.

3) Where a podium, terrace, platform or contained open space is provided, egress requirements shall conform to the appropriate requirements for rooms or *suites* in Article 9.9.7.4.

4) Except as required by Sentence (2), *means of egress* at the roof level, designed in conformance with the requirements for *exits* shall be provided from an *occupancy* on a roof serving more than a single *dwelling unit*.

#### **9.9.7.2. Means of Egress from Suites**

1) Except as required in Sentence 9.9.9.3.(1), each *suite* in a *floor area* occupied by more than one *suite* shall have

- a) an exterior *exit* doorway,
- b) a doorway to a *public corridor*, or
- c) a doorway to an exterior passageway.

2) Except as provided in Sentences 9.9.7.3.(1) and 9.9.8.2.(2), from the point where a doorway described in Clause (1)(b) or (c) enters the *public corridor* or exterior passageway, it shall be possible to go in opposite directions to each of 2 separate *exits*.

**9.9.7.3. Dead-End Corridors**

1) Except for a dead-end corridor that is entirely within a *suite* and except as permitted in Sentence 9.9.9.2.(1), a dead-end corridor is permitted provided it is not more than 6 m long.

**9.9.7.4. Number and Spacing of Egress Doors**

1) Except for *dwelling units*, at least 2 egress doors shall be provided when the area of a room or *suite*, or the distance measured from any point within the room or *suite* to the nearest egress door, exceeds the values in Table 9.9.7.4.

2) Doors required in Sentence (1) shall be spaced so that in the event that one door is made inaccessible by a fire within such room or *suite*, the other door will provide safe egress.

**Table 9.9.7.4.**

**Maximum Areas and Travel Distances for Rooms, Suites and Mezzanines with a Single Means of Egress**

**Forming Part of Sentences 9.9.7.4.(1) and 9.9.8.6.(2)**

<i>Occupancy of Room, Suite or Floor Area</i>	<i>Maximum Area of Room, Suite or Floor Area, m²</i>	<i>Maximum Distance to Egress Door, m</i>
Group C (except <i>dwelling units</i> )	100	15
Group D	200	25
Group E	150	15
Group F, Division 2	150	10
Group F, Division 3	200	15

**9.9.7.5. Independent Access to Exit**

1) Required *access to exit* from *suites* shall not be through any other *dwelling unit*, *service room* or other *occupancy*.

**9.9.7.6. Travel Distance within Rooms and Suites**

1) Except for *dwelling units*, the travel distance from any point within the room or *suite* to the nearest egress door shall not exceed the maximum travel distance in Article 9.9.8.2.

**9.9.8. Exits from Floor Areas**

**9.9.8.1. Measurement of Travel Distance**

1) Except as provided in Sentences (2) and (3), for the purposes of this Subsection, travel distance means the distance from any point in the *floor area* to an *exit* measured along the path of *exit* travel.

2) Where a room or *suite* is separated from the remainder of the *floor area* by a *fire separation* having a *fire-resistance rating* of at least 45 min or, in a *sprinklered building*, by a *fire separation* which is not required to have a *fire-resistance rating*, the travel distance may be measured from an egress door of the room or *suite* to the nearest *exit*.

3) Where a *public corridor* is not less than 9 m wide and conforms to Subclauses 3.4.2.5.(1)(d)(i) to (d)(iv), the travel distance may be determined in accordance with those Subclauses.

#### **9.9.8.2. Number of Required Exits**

1) Except as provided in Sentence (2) and Subsection 9.9.9., at least 2 *exits* shall be provided from every *floor area*, spaced so that the travel distance to the nearest *exit* is not more than

- a) 40 m in the case of *business and personal services occupancies*,
- b) 45 m for all *occupancies* where the *floor area* is *sprinklered*, and
- c) 30 m for all other *occupancies*.

2) Except as provided in Subsection 9.9.9., a single *exit* is permitted from each *storey* in *buildings* of 1 and 2 *storeys* in *building height* provided the *floor area* and travel distance requirements conform to those required in Article 9.9.7.4. and the total *occupant load* served by an *exit* facility does not exceed 60 persons.

#### **9.9.8.3. Contribution of Each Exit**

1) Where more than one *exit* is required from a *floor area*, each *exit* shall be considered as contributing not more than half the required *exit* width.

#### **9.9.8.4. Location of Exits**

1) Where more than one *exit* is required from a *floor area*, at least 2 *exits* shall be independent of each other and be placed remote from each other along the path of travel between them. (See Note A-9.9.8.4.(1).)

#### **9.9.8.5. Exiting through a Lobby**

1) Not more than one *exit* from a *floor area* above or below the *first storey* is permitted to lead through a lobby.

2) The lobby referred to in Sentence (1) shall be not more than 4.5 m above *grade*, and the path of travel through the lobby to the outdoors shall not exceed 15 m.

3) The lobby referred to in Sentence (1) shall conform in all respects to the requirements for *exits*, except that rooms other than *service rooms*, storage rooms and rooms of *residential* or *industrial occupancy* are permitted to open directly onto such lobby.

4) Where the lobby referred to in Sentence (1) and adjacent *occupancies* that are permitted to open into the lobby are *sprinklered*, the *fire separation* between such *occupancies* and the lobby need not have a *fire-resistance rating*. (See Note A-3.4.4.2.(2)(e).)

5) Passenger elevators are permitted to open onto the lobby referred to in Sentence (1) provided the elevator doors are designed to remain closed except while loading and unloading passengers.

#### **9.9.8.6. Mezzanine Means of Egress**

1) Except as permitted by Sentences (2) and (3), the space above a *mezzanine* shall be served by *means of egress* leading to *exits* accessible at the *mezzanine* level, on the same basis as *floor areas*.

2) The *means of egress* from a *mezzanine* need not conform to Sentence (1), provided

- a) the *mezzanine* is not required to terminate at a vertical *fire separation*, as permitted by Sentence 9.10.12.1.(2),
- b) the *occupant load* of the *mezzanine* is not more than 60,
- c) the area of the *mezzanine* does not exceed the area limits stated in Table 9.9.7.4., and
- d) the distance limits stated in Table 9.9.7.4., measured along the path of travel, are not exceeded from any point on the *mezzanine* to
  - i) an egress door serving the space that the *mezzanine* overlooks if the space is served by a single egress door, or
  - ii) an egress stairway leading to an *access to exit* in the space below if that space is required to be served by 2 or more egress doorways in conformance with Sentence 9.9.7.4.(1).
- 3) One of the *means of egress* from a *mezzanine* that is not required to terminate at a *fire separation*, as permitted by Sentence 9.10.12.1.(2), and that exceeds the limits of Sentence (2) is permitted to lead through the room in which the *mezzanine* is located, provided all other *means of egress* from that *mezzanine* lead to *exits* accessible at the *mezzanine* level.
- 4) Except as provided in Sentence (2), the maximum travel distance from any point on a *mezzanine* to the nearest *exit* shall be not more than
  - a) 40 m in a *business and personal services occupancy*,
  - b) 45 m in a *floor area* that is *sprinklered* throughout, provided it does not contain a *high-hazard industrial occupancy*, or
  - c) 30 m in any *floor area* not referred to in Clause (a) or (b).

### **9.9.9. Egress from Dwelling Units**

#### **9.9.9.1. Travel Limit to Exits or Egress Doors**

- 1) Except as provided in Sentences (2) and (3), every *dwelling unit* containing more than 1 *storey* shall have *exits* or egress doors located so that it shall not be necessary to travel up or down more than 1 *storey* in a *building*, or more than 2 *storeys* in a *sprinklered building*, to reach a level served by
  - a) an egress door to a *public corridor*, enclosed *exit* stair or exterior passageway, or
  - b) an *exit* doorway located within 1 *storey* of not more than 1.5 m above adjacent ground level.
- 2) Where a *dwelling unit* is not located above or below another *suite*, the travel limit from a floor level in the *dwelling unit* to an *exit* or egress door may exceed 1 *storey* where that floor level is served by an openable window
  - a) providing an unobstructed opening of not less than 1 m in height and 0.55 m in width, and
  - b) located so that the sill is not more than
    - i) 1 m above the floor, and
    - ii) 7 m above adjacent ground level.
- 3) The travel limit from a floor level in a *dwelling unit* to an *exit* or egress door may exceed 1 *storey* where that floor level has direct access to a balcony.

#### **9.9.9.2. Two Separate Exits**

1) Except as provided in Sentence (2) and Sentence 9.9.7.3.(1), where an egress door from a *dwelling unit* opens onto a *public corridor* or exterior passageway it shall be possible from the location where the egress door opens onto the corridor or exterior passageway to go in opposite directions to 2 separate *exits* unless the *dwelling unit* has a second and separate *means of egress*.

2) For *dwelling units* in a single detached house, it need not be possible to go in more than one direction to an *exit* from the location where the egress door opens into a *public corridor* or exterior passageway if the *building* is *sprinklered* or if each *dwelling unit* has separate and direct access from each *storey* to

- a) a balcony, or
- b) an openable window conforming to Clauses 9.9.9.1.(2)(a) and (b).

### **9.9.9.3. Shared Egress Facilities**

1) Except as provided in Sentences (2) and (3), a *dwelling unit* shall be provided with a second and separate *means of egress* where an egress door from the *dwelling unit* opens onto

- a) an *exit* stairway serving more than one *suite*,
- b) a *public corridor*
  - i) serving more than one *suite*, and
  - ii) served by a single *exit*,
- c) an exterior passageway
  - i) serving more than one *suite*,
  - ii) served by a single *exit* stairway or *ramp*, and
  - iii) more than 1.5 m above adjacent ground level, or
- d) a balcony
  - i) serving more than one *suite*,
  - ii) served by a single *exit* stairway or *ramp*, and
  - iii) more than 1.5 m above adjacent ground level.

2) Where a *dwelling unit* is located above another *dwelling unit* or common space in a single detached house, the upper *dwelling unit* shall be provided with a second and separate *means of egress* where an egress door from that *dwelling unit* opens onto an exterior passageway that

- a) has a floor assembly with a *fire-resistance rating* less than 45 min,
- b) is served by a single *exit* stairway or *ramp*, and
- c) is located more than 1.5 m above adjacent ground level.

3) For *dwelling units* in a single detached house-where an egress door from either *dwelling unit* opens onto a shared egress facility served by a single *exit* stairway or ramp, other than as described in Sentence (2), a second and separate *means of egress* need not be provided if the *building* is *sprinklered* or if the *dwelling units* have separate and direct access from each *storey* to

- a) a balcony, or
- b) an openable window conforming to Clauses 9.9.9.1.(2)(a) and (b).

### **9.9.10. Egress from Bedrooms**

#### **9.9.10.1. Egress Windows or Doors for Bedrooms**

1) Except where the *suite* is *sprinklered*, each bedroom or combination bedroom shall have at least one outside window or exterior door openable from the inside without the use of keys, tools or special knowledge and without the removal of sashes or hardware. (See Article 9.5.1.2. and Note A-9.9.10.1.(1).)

2) The window referred to in Sentence (1) shall

a) provide an unobstructed opening of not less than 0.35 m<sup>2</sup> in area with no dimension less than 380 mm, and

b) maintain the required opening during an emergency without the need for additional support.

(See Note A-9.9.10.1.(2).)

3) Where a window required in Sentence (1) opens into a window well, a clearance of not less than 760 mm shall be provided in front of the window. (See Note A-9.9.10.1.(3).)

4) Where the sash of a window referred to in Sentence (3) swings towards the window well, the operation of the sash shall not reduce the clearance in a manner that would restrict escape in an emergency.

5) Where a protective enclosure is installed over the window well referred to in Sentence (3), the enclosure shall be openable from the inside without the use of keys, tools or special knowledge of the opening mechanism.

## **9.9.11. Signs**

### **9.9.11.1. Application**

1) This Subsection applies to all *exits* except those serving not more than one *dwelling unit* or a single detached house.

### **9.9.11.2. Visibility of Exits**

1) *Exits* shall be located so as to be clearly visible or their locations shall be clearly indicated.

2) Where an *exit* door leading directly to the outside is subject to being obstructed by parked vehicles or storage because of its location, a visible sign or a physical barrier prohibiting such obstructions shall be installed on the exterior side of the door.

### **9.9.11.3. Exit Signs**

1) Every *exit* door shall have an *exit* sign providing visual information placed over it or adjacent to it if the *exit* serves

a) a *building* that is 3 *storeys* in *building height*,

b) a *building* having an *occupant load* of more than 150, or

c) a room or *floor area* that has a fire escape as part of a required *means of egress*.

2) Every *exit* sign providing visual information shall

a) be visible on approach to the *exit*,

b) consist of a green and white or lightly tinted graphical symbol meeting the colour specifications referred to in ISO 3864-1, "Graphical symbols – Safety colours and safety signs – Part 1: Design principles for safety signs and safety markings," and

c) conform to ISO 7010, "Graphical symbols – Safety colours and safety signs – Registered safety signs," for the following symbols (see Note A-3.4.5.1.(2)(c)):



- i) E001 emergency exit left,
  - ii) E002 emergency exit right,
  - iii) E005 90-degree directional arrow, and
  - iv) E006 45-degree directional arrow.
- 3) Internally illuminated *exit* signs shall be continuously illuminated and
- a) where illumination of the sign is powered by an electrical circuit, be constructed in conformance with CSA C22.2 No. 141, "Emergency lighting equipment," or
  - b) where illumination of the sign is not powered by an electrical circuit, be constructed in conformance with CAN/ULC-S572, "Standard for Photoluminescent and Self-Luminous Exit Signs and Path Marking Systems."
- 4) Externally illuminated *exit* signs shall be continuously illuminated and be constructed in conformance with CAN/ULC-S572, "Standard for Photoluminescent and Self-Luminous Exit Signs and Path Marking Systems." (See Note A-3.4.5.1.(4).)
- 5) The circuitry serving lighting for externally and internally illuminated *exit* signs shall
- a) serve no equipment other than emergency equipment, and
  - b) be connected to an emergency power supply as described in Sentences 9.9.12.3.(2), (3) and (7).
- 6) Where no *exit* is visible from a *public corridor*, from a corridor used by the public, or from principal routes serving an open *floor area* having an *occupant load* of more than 150, an *exit* sign conforming to Clauses (2)(b) and (c) with an arrow or pointer indicating the direction of egress shall be provided.

7) *Exit* signs with tactile information shall be provided in accordance with Article 3.4.5.2.

#### **9.9.11.4. Signs for Stairs and Ramps at Exit Level**

1) In *buildings* that are 3 *storeys* in *building height*, any part of an *exit ramp* or stairway that continues up or down past the lowest *exit level* shall be clearly marked to indicate that it does not lead to an *exit*, if the portion beyond the *exit level* may be mistaken as the direction of *exit* travel.

#### **9.9.11.5. Floor Numbering**

- 1) Arabic numerals indicating the assigned floor number shall be
- a) mounted permanently on the stair side of the wall at the latch side of doors to *exit* stair shafts,
  - b) not less than 60 mm high, raised approximately 0.8 mm above the surface,
  - c) located 1 500 mm from the finished floor and not more than 300 mm from the door, and
  - d) contrasting in colour with the surface on which they are applied (see Note A-9.9.11.5.(1)(d)).

### **9.9.12. Lighting**

#### **9.9.12.1. Application**

1) This Subsection applies to the lighting of all *means of egress* except those within *dwelling units* or a single detached house.

#### **9.9.12.2. Required Lighting in Egress Facilities**

1) Every *exit, public corridor* or corridor providing *access to exit* for the public shall be equipped to provide illumination to an average level of not less than 50 lx at floor or tread level and at all points such as angles and intersections at changes of level where there are stairs or *ramps*.

2) The minimum value of the illumination required by Sentence (1) shall be not less than 10 lx.

### **9.9.12.3. Emergency Lighting**

1) Emergency lighting shall be provided in

a) *exits,*

b) principal routes providing *access to exit* in an open *floor area,*

c) corridors used by the public,

d) underground *walkways,*

e) *public corridors,*

f) public washrooms that are equipped to serve more than one person at a time,

g) locations where doors are equipped with an electromagnetic lock as described in Clauses 3.4.6.16.(5)(k) and (6)(g), and

h) universal washrooms, universal shower rooms and *accessible* change spaces required by Article 3.8.2.8.

2) Emergency lighting required in Sentence (1) shall be provided from a source of energy separate from the electrical supply for the *building*.

3) Lighting required in Sentence (1) shall be designed to be automatically actuated for a period of at least 30 min when the electric lighting in the affected area is interrupted.

4) Illumination from lighting required in Sentence (1) shall be provided to average levels of not less than 10 lx at floor or tread level.

5) The minimum value of the illumination required by Sentence (4) shall be not less than 1 lx.

6) Where incandescent lighting is provided, lighting equal to 1 W/m<sup>2</sup> of *floor area* shall be considered to meet the requirement in Sentence (4).

7) Where self-contained emergency lighting units are used, they shall conform to CSA C22.2 No. 141, "Emergency lighting equipment."

## **Section 9.10. Fire Protection**

### **9.10.1. Definitions and Application**

#### **9.10.1.1. Sloped Roofs**

1) For the purposes of this Section, roofs with slopes of 60° or more to the horizontal that are adjacent to a room or space intended for *occupancy* shall be considered as a wall.

#### **9.10.1.2. Testing of Integrated Fire Protection and Life Safety Systems**

1) Where life safety and fire protection systems and systems with fire protection and life safety functions are integrated with each other, they shall be tested as a whole in accordance with CAN/ULC-S1001, "Standard for Integrated Systems Testing of Fire Protection and Life Safety"

Systems,” and the Fire By-law, to verify that they have been properly integrated. (See Note A-3.2.9.1.(1).)

**9.10.1.3. Items under Part 3 Jurisdiction**

- 1) Tents, *air-supported structures*, transformer vaults, *walkways*, elevators and escalators shall conform to Part 3.
- 2) Where rooms or spaces are intended for an *assembly occupancy*, such rooms or spaces shall conform to Part 3.
- 3) *Basements* containing more than 1 *storey* or exceeding 600 m<sup>2</sup> in area shall conform to Part 3.
- 4) Where rooms or spaces are intended for the storage, manufacture or use of hazardous or explosive material, such rooms or spaces shall conform to Part 3. (See Note A-3.3.1.2.(1).)
- 5) Except as provided in Article 3.3.5.8., facilities for the dispensing of fuel shall not be installed in any *building*.
- 6) Openings through floors that are not protected by shafts or *closures* shall be protected in conformance with Subsection 3.2.8. (See also Sentence 9.9.4.7.(1).)
- 7) Chutes and shafts shall conform to Subsection 3.6.3. except where they are entirely contained within a *dwelling unit*.
- 8) Sprinkler systems shall be designed, constructed and installed in conformance with Articles 3.2.5.12. to 3.2.5.15. and 3.2.5.17.
- 9) Standpipe and hose systems shall be designed, constructed and installed in conformance with Articles 3.2.5.8. to 3.2.5.11. and 3.2.5.17.
- 10) Fire pumps shall be installed in conformance with Articles 3.2.5.17. and 3.2.5.18.
- 11) Where fuel-fired *appliances* are installed on a roof, such *appliances* shall be installed in conformance with Article 3.6.1.5.

**9.10.1.4. Items under Part 6 Jurisdiction**

- 1) In kitchens containing commercial cooking equipment used in processes producing grease-laden vapours, the equipment shall be designed and installed in conformance with Article 6.3.1.6. (See Note A-9.10.1.4.(1).)

**9.10.2. Occupancy Classification**

**9.10.2.1. Occupancy Classification**

- 1) Except as provided in Article 9.10.2.2., every *building* or part thereof shall be classified according to its *major occupancy* as belonging to one of the groups or divisions described in Table 9.10.2.1.

**Table 9.10.2.1.**

**Occupancy Classifications**

**Forming Part of Sentence 9.10.2.1.(1)**

Group	Division	Description of <i>Major Occupancies</i> <sup>(1)</sup>
C	—	<i>Residential occupancies</i>
D	—	<i>Business and personal services occupancies</i>
E	—	<i>Mercantile occupancies</i>

F	2	Medium-hazard industrial occupancies
F	3	Low-hazard industrial occupancies (Does not include storage garages serving individual dwelling units)

**Notes to Table 9.10.2.1.:**

<sup>(1)</sup> See Note A-3.1.2.1.(1).

- 2)** A *storage garage* or carport that serves one or more residential *buildings*, may be considered an ancillary use to a Group C *major occupancy* provided that
- it serves *buildings* of only *residential occupancy*,
  - the *storage garage* or carport contains no other *major occupancy*, and
  - the *storage garage* or carport is on the same property as the *buildings* to which it is deemed ancillary.

**9.10.2.2. Custodial, Convalescent and Residential Care Homes**

1) Children's custodial homes and convalescent homes for ambulatory occupants living as a single housekeeping unit in a *dwelling unit* with sleeping accommodation for not more than 10 persons are permitted to be classified as *residential occupancies* (Group C).

- Reserved.
- Reserved.
- Reserved.
- Reserved.

6) A care facility accepted for residential use pursuant to provincial legislation is permitted to be classified as a *residential occupancy*, provided

- occupants live as a single housekeeping unit in a *dwelling unit* with sleeping accommodation for not more than 10 persons,
- smoke alarms* are installed in conformance with Subsection 9.10.19.,
- emergency lighting is provided in conformance with Article 9.9.12.3., and
- the *building* is *sprinklered* throughout.

**9.10.2.3. Major Occupancies above Other Major Occupancies**

1) Except as permitted in Article 9.10.2.4., in any *building* containing more than one *major occupancy* in which one *major occupancy* is located entirely above another, the requirements of Article 9.10.8.1. for each portion of the *building* containing a *major occupancy* shall be applied to that portion as if the entire *building* was of that *major occupancy*.

**9.10.2.4. Buildings Containing More Than One Major Occupancy**

1) In a *building* containing more than one *major occupancy*, where the aggregate area of all *major occupancies* in a particular group or division does not exceed 10% of the *floor area* on the *storey* on which they are located, they need not be considered as *major occupancies* for the purposes of Articles 9.10.8.1. and 9.10.2.3. provided they are not classified as Group F, Division 2 *occupancies*.

**9.10.2.5. Group A, Division 2, Low Occupant Load**

1) This Part may apply to a Group A, Division 2 *assembly occupancy* that is permitted by Article 3.1.2.7. to be classified as a Group D, *business and personal services occupancy*, provided the *building* in which the *assembly occupancy* is located complies with Sentence 1.3.3.3.(1) of Division A. (See Note A-3.1.2.7.)

### 9.10.3. Ratings

#### 9.10.3.1. Fire-Resistance and Fire-Protection Ratings

1) Except as permitted in Sentences (2) and (3), where a *fire-resistance rating* or a *fire-protection rating* is required in this Section for an element of a *building*, such rating shall be determined in conformance with

- a) the test methods described in Part 3,
  - b) the calculation method presented in Appendix D, or
  - c) the construction specifications presented in Tables 9.10.3.1.-A and 9.10.3.1.-B. (See Note A-9.10.3.1.(1)(c).)
- 2) In a single detached house, where a minimum *fire-resistance rating* of 15 min is permitted, the construction described in Clause 9.11.1.1.(2)(a) is permitted to be used.
- 3) In a single detached house, where a minimum *fire-resistance rating* of 30 min is permitted, it is permitted to use construction having
- a) walls and floor/ceiling assemblies framed with wood studs,
  - b) joist spaces filled with
    - i) preformed insulation of rock or slag fibres conforming to CAN/ULC-S702, "Mineral Fibre Thermal Insulation for Buildings," having a mass per unit area of not less than 1.22 kg/m<sup>2</sup> of floor surface, or
    - ii) wet-blown cellulose fibres conforming to CAN/ULC-S703, "Cellulose Fibre Insulation for Buildings," having a density of not less than 50 kg/m<sup>3</sup> to a minimum depth of 90 mm on the underside of the subfloor and the sides of the structural members,
  - c) stud spaces of
    - i) *non-loadbearing* assemblies filled with preformed insulation of glass fibres conforming to CAN/ULC-S702.1, "Standard for Mineral Fibre Thermal Insulation for Buildings, Part 1: Material Specification," having a mass per unit area of not less than 0.6 kg/m<sup>2</sup> of wall surface, and
    - ii) *loadbearing* assemblies filled with preformed insulation of rock or slag fibres conforming to CAN/ULC-S702.1, "Standard for Mineral Fibre Thermal Insulation for Buildings, Part 1: Material Specification," having a mass per unit area of not less than 1.22 kg/m<sup>2</sup> of wall surface, or filled with insulation of cellulose fibres conforming to CAN/ULC-S703, "Standard for Cellulose Fibre Insulation (CFI) for Buildings," having a density of not less than 50 kg/m<sup>3</sup>,
  - d) resilient channel on one side of the *fire separation* spaced 400 or 600 mm o.c., and
  - e) not less than 12.7 mm thick gypsum board on ceilings and on both sides of walls. (See also Clause 9.11.1.1.(2)(a).)

#### 9.10.3.2. Flame-Spread Ratings

1) Where a *flame-spread rating* is required in this Section for an element of a *building*, such rating shall be determined in accordance with the test methods described in Part 3, or in accordance with Appendix D.

2) Unless the *flame-spread rating* is referred to herein as a "surface *flame-spread rating*," it shall apply to any surface of the element being considered that would be exposed by cutting through it as well as to the exposed surface of the element.

#### 9.10.3.3. Fire Exposure

- 1) Floor, roof and ceiling assemblies shall be rated for exposure to fire on the underside.
- 2) Exterior walls shall be rated for exposure to fire from inside the *building*, except that such walls need not comply with the temperature rise limitations required by the standard tests referred to in Article 9.10.3.1. if such walls have a *limiting distance* of not less than 1.2 m, and due allowance is made for the effects of heat radiation in accordance with the requirements in Part 3.
- 3) Interior vertical *fire separations* required to have *fire-resistance ratings* shall be rated for exposure to fire on each side.

#### **9.10.3.4. Suspended Membrane Ceilings**

- 1) Where a ceiling construction has a suspended membrane ceiling with lay-in panels or tiles which contribute to the required *fire-resistance rating*, hold down clips or other means shall be provided to prevent the lifting of such panels or tiles in the event of a fire.

### **9.10.4. Building Size Determination**

#### **9.10.4.1. Mezzanines not Considered as Storeys**

- 1) Except as required by Sentences (2) and 9.10.4.2.(1), the space above a *mezzanine* is permitted to be excluded from the calculation of *building height*, provided
  - a) the aggregate area of *mezzanines* that are not superimposed does not exceed 10% of the *floor area* of the *building* in which they are located, and
  - b) the area of *mezzanine* in a *suite* does not exceed 10% of the area of that *suite* on the *storey* on which it is located.
- 2) Except as required by Sentence 9.10.4.2.(1), the space above a *mezzanine* is permitted to be excluded from the calculation of *building height*, provided
  - a) the aggregate area of *mezzanines* that are not superimposed does not exceed 40% of the open area of the room in which they are located (see Note A-3.2.1.1.(3)(a)), and
  - b) except as permitted in Sentence (3), the space above the *mezzanine* floor is used as an open area without *partitions* or subdividing walls higher than 1 070 mm above the *mezzanine* floor.
- 3) The space above a *mezzanine* conforming to Sentence (2) is permitted to include an enclosed space whose area does not exceed 10% of the open area of the room in which the *mezzanine* is located, provided the enclosed space does not obstruct visual communication between the open space above the *mezzanine* and the room in which it is located.
- 4) For the purpose of determining *occupant load*, the areas of *mezzanines* that are not considered as *storeys* shall be added to the *floor area* of the *storey* on which they are located. (See Note A-9.10.4.1.(4).)
- 5) Platforms and catwalks intended solely for periodic inspection and maintenance need not be considered as floor assemblies or *mezzanines* for the purpose of calculating *building height*, provided
  - a) they are not used for storage, and
  - b) they are constructed with *noncombustible* materials, unless the *building* is permitted to be of *combustible construction*.

#### **9.10.4.2. More Than One Level of Mezzanine**

- 1) Each level of *mezzanine* that is partly or wholly superimposed above the first level of *mezzanine* shall be considered as a *storey* in calculating the *building height*.

#### **9.10.4.3. Basement Storage Garages**

1) Where a *basement* is used primarily as a *storage garage*, the *basement* is permitted to be considered as a separate *building* for the purposes of this Section provided the floor above the *basement* and the exterior walls of the *basement* above the adjoining ground level are constructed as *fire separations* of masonry or concrete having a *fire-resistance rating* of not less than 2 h.

#### **9.10.4.4. Rooftop Enclosures**

1) A rooftop enclosure shall not be considered as a *storey* in calculating the *building height* if the rooftop enclosure is provided for

- a) elevator machinery,
- b) a *service room*,
- c) a stairway used for no purpose other than for access or egress,
- d) an elevator lobby used for no purpose other than for access or egress, or
- e) a combination thereof.

#### **9.10.5. Permitted Openings in Wall and Ceiling Membranes**

##### **9.10.5.1. Permitted Openings in Wall and Ceiling Membranes**

1) Except as permitted in Sentences (2) and (3), a membrane forming part of an assembly required to have a *fire-resistance rating* shall not be pierced by openings into the assembly unless the assembly has been tested and rated for such openings.

2) A wall or ceiling membrane forming part of an assembly required to have a *fire-resistance rating* is permitted to be pierced by openings for electrical and similar service outlet boxes, provided such outlet boxes and the penetrations conform to Article 9.10.9.8.

3) A membrane ceiling forming part of an assembly assigned a *fire-resistance rating* on the basis of Table 9.10.3.1.-B or Appendix D is permitted to be pierced by openings leading to ducts within the ceiling space, provided the ducts, the amount of openings and their protection conform to the requirements of Appendix D.

#### **9.10.6. Construction Types**

##### **9.10.6.1. Combustible Elements in Noncombustible Construction**

1) Where a *building* or part of a *building* is required to be of *noncombustible construction*, *combustible* elements shall be limited in conformance with the requirements in Subsection 3.1.5.

##### **9.10.6.2. Heavy Timber Construction**

1) *Heavy timber construction* shall be considered to have a 45 min *fire-resistance rating* when it is constructed in accordance with the requirements for *heavy timber construction* in Article 3.1.4.7.

#### **9.10.7. Steel Members**

##### **9.10.7.1. Protection of Steel Members**

1) Except as permitted in Article 3.2.2.3., structural steel members used in construction required to have a *fire-resistance rating* shall be protected to provide the required *fire-resistance rating*.

#### **9.10.8. Fire Resistance and Combustibility in Relation to Occupancy, Height and Supported Elements**

##### **9.10.8.1. Fire-Resistance Ratings for Floors and Roofs**

1) Except as otherwise provided in this Subsection, the *fire-resistance ratings* of floors and roofs shall conform to Table 9.10.8.1. (See Subsection 9.10.2. for mixed *occupancies* and Subsection 9.10.21. for construction camps.)

**Table 9.10.8.1.**

**Fire-Resistance Ratings for Floors and Roofs**

**Forming Part of Sentence 9.10.8.1.(1)**

<i>Major Occupancy</i>	<i>Maximum Building Height, storeys</i>	<i>Minimum Fire-Resistance Rating by Building Element, min</i>		
		<i>Floors Except Floors over Crawl Spaces</i>	<i>Mezzanine Floors</i>	<i>Roofs</i>
Residential (Group C)	3	45	45	—
All other <i>occupancies</i>	2	45	—	—
	3	45	45	45

**9.10.8.2. Fire-Resistance Ratings in Sprinklered Buildings**

1) The requirements in Table 9.10.8.1. for roof assemblies to have a *fire-resistance rating* are permitted to be waived in *sprinklered buildings* where

a) the sprinkler system is electrically supervised in conformance with Sentence 3.2.4.9.(3), and

b) the operation of the sprinkler system will cause a signal to be transmitted to the fire department in conformance with Sentence 3.2.4.7.(4).

**9.10.8.3. Fire-Resistance Ratings for Walls, Columns and Arches**

1) Except as otherwise provided in this Subsection, all *loadbearing* walls, columns and arches in the *storey* immediately below a floor or roof assembly shall have a *fire-resistance rating* of not less than that required for the supported floor or roof assembly.

2) Light-frame walls, columns, arches and beams as well as *loadbearing* steel elements that support floors between *dwelling units* in a single detached house shall be protected by not less than 12.7 mm thick gypsum board. (See Note A-9.10.8.3.(2).)

**9.10.8.4. Support of Noncombustible Construction**

1) Where an assembly is required to be of *noncombustible construction* and to have a *fire-resistance rating*, it shall be supported by *noncombustible construction*.

**9.10.8.5. Service Rooms**

1) *Construction* supporting a *service room* need not conform to Article 9.10.8.3.

**9.10.8.6. Mezzanines**

1) *Mezzanines* required to be counted as *storeys* in Articles 9.10.4.1. and 9.10.4.2. shall be constructed in conformance with the requirements for “Floors Except Floors over Crawl Spaces” in Table 9.10.8.1.

**9.10.8.7. Roofs Supporting an Occupancy**

1) Where a portion of a roof supports an *occupancy*, that portion shall be constructed as a *fire separation* having a *fire-resistance rating* conforming to the rating for “Floors Except Floors over Crawl Spaces” in Table 9.10.8.1.

**9.10.8.8. Floors of Exterior Passageways**



1) Except as provided in Sentences (2) and (3), the floor assembly of every exterior passageway used as part of a *means of egress* shall have a *fire-resistance rating* of not less than 45 min or be of *noncombustible construction*.

2) No *fire-resistance rating* is required for floors of exterior passageways serving *buildings* of Group D, E or F *major occupancy* that are not more than 2 *storeys* in *building height*.

3) No *fire-resistance rating* is required for floors of exterior passageways serving

a) reserved,

b) a single *dwelling unit* where no *suite* is located above or below the *dwelling unit* (see also Sentence 9.9.9.3.(2)).

#### **9.10.8.9. Crawl Spaces**

1) Where a crawl space exceeds 1.8 m in height or is used for any *occupancy* or as a *plenum* in *combustible construction* or for the passage of *flue pipes*, it shall be considered as a *basement* in applying the requirements in Article 9.10.8.1.

#### **9.10.8.10. Application to Houses**

1) Table 9.10.8.1. does not apply to

a) a *dwelling unit* that has no other *dwelling unit* above or below it,

b) single detached houses, or

c) a *dwelling unit* that is not above or below another *major occupancy*.

#### **9.10.8.11. Part 3 as an Alternative**

1) The *fire-resistance ratings* of floors, roofs, *loadbearing* walls, columns and arches need not conform to this Subsection if such assemblies conform in all respects to the appropriate requirements in Section 3.2.

### **9.10.9. Fire Separations and Smoke-tight Barriers between Rooms and Spaces within Buildings**

#### **9.10.9.1. Application**

1) This Subsection applies to

a) *fire separations* required between rooms and spaces in *buildings*, except between rooms and spaces within a *dwelling unit*, and

b) reserved.

#### **9.10.9.2. Continuous Barrier**

1) Except as permitted in Article 9.10.9.3., a wall or floor assembly required to be a *fire separation* shall be constructed as a continuous barrier against the spread of fire and retard the passage of smoke.

2) Reserved.

3) Except as provided in Sentence (6), the continuity of a *fire separation* where it abuts another *fire separation*, a floor, a ceiling, or a roof shall be maintained by a *firestop* that, when subjected to the fire test method in CAN/ULC-S115, "Standard Method of Fire Tests of Firestop Systems," has an FT rating not less than the *fire-resistance rating* for the abutting *fire separation*. (See Note A-3.1.8.3.(2).)

4) Except as provided in Sentence (6), joints located in a horizontal plane between a floor and an exterior wall shall be sealed by a *firestop* that, when subjected to the fire test method in ASTM E2307, "Standard Test Method for Determining Fire Resistance of Perimeter Fire Barriers Using Intermediate-Scale, Multi-storey Test Apparatus," has an F rating not less than the *fire-resistance rating* for the horizontal *fire separation*.

5) Except as provided in Sentence (6), all gypsum board joints in the assemblies described in Sentence (1) shall conform to CSA A82.31-M, "Gypsum Board Application," to maintain the integrity of the smoke-tight barrier over the entire surface.

6) Joints between ceilings and walls, between floors and walls, and between walls at corners need not comply with Sentences (3) to (5) where such joints consist of gypsum board that is attached to framing members and arranged so as to restrict the passage of flame and smoke through the joints. (See Note A-3.1.8.3.(5).)

#### **9.10.9.3. Openings to be Protected with Closures**

1) Except as permitted in Articles 9.10.9.5. to 9.10.9.8., openings in required *fire separations* shall be protected with *closures* conforming to Subsection 9.10.13.

2) Doors in a *fire separation* with a required *fire-resistance rating* of 15 min, but not greater than 45 min, need not have a *fire-protection rating* provided they

- a) are at least 45 mm thick solid core wood doors, and
- b) have a self-closing device.

(See Subsection 9.10.13. and Note A-9.10.9.3.(2).)

3) Doors in a partition conforming with Sentence 9.10.9.16.(5) between a principal *dwelling unit* and its *subordinate ancillary residential unit*, shall be protected with a closure with a minimum *fire-protection rating* of 20 minute conforming to Article 9.10.13.2.

#### **9.10.9.4. Floor Assemblies**

1) Except as permitted in Sentences (2) to (4), all floor assemblies shall be constructed as *fire separations*.

2) Floor assemblies contained within *dwelling units* and within houses with a *secondary suite* need not be constructed as *fire separations*.

3) Floor assemblies for which no *fire-resistance rating* is required by Subsection 9.10.8. and floors of *mezzanines* not required to be counted as *storeys* in Articles 9.10.4.1. and 9.10.4.2. need not be constructed as *fire separations*.

4) Where a crawl space is not required by Article 9.10.8.9. to be constructed as a *basement*, the floor above it need not be constructed as a *fire separation*.

#### **9.10.9.5. Interconnected Floor Spaces**

1) *Interconnected floor spaces* shall conform to Subsection 3.2.8.

#### **9.10.9.6. General Requirements for Penetrations of Fire Separations**

(See Note A-3.1.9.)

1) Except as required by Sentence (2) and Articles 9.10.9.7. and 9.10.9.8. and as permitted by Article 9.10.9.9., penetrations of a required *fire separation* or a membrane forming part of an assembly required to be a *fire separation* shall be

a) sealed by a *firestop* that, when subjected to the fire test method in CAN/ULC-S115, "Standard Method of Fire Tests of Firestop Systems," has an F rating not less than the required *fire-resistance rating* for the *fire separation*,

b) tightly fitted or cast in place, provided the penetrating item is made of steel, ferrous, copper, concrete or masonry, or

c) sealed to maintain the integrity of the *fire separation*.

(See Note A-9.10.9.6.(1).)

2) Penetrations of a *firewall* shall be sealed at the penetration by a *firestop* that, when subjected to the fire test method in CAN/ULC-S115, "Standard Method of Fire Tests of Firestop Systems," has an FT rating not less than the *fire-resistance rating* for the *fire separation*.

#### **9.10.9.7. Piping Penetrations**

(See Note A-3.1.9.)

1) Except as provided in Sentences (2) and (5), piping for drain, waste, vent and central vacuum systems that is not located in a vertical shaft is permitted to penetrate a *fire separation* required to have a *fire-resistance rating* or a membrane that forms part of an assembly required to have a *fire-resistance rating*, provided the penetration is protected in accordance with Clause 9.10.9.6.(1)(a) or (b).

2) Drain piping leading directly from a water closet through a concrete floor slab is permitted to penetrate a horizontal *fire separation* or a membrane that contributes to the required *fire-resistance rating* of a horizontal *fire separation*, provided

a) the piping is *noncombustible* and the penetration is protected in accordance with Sentence 9.10.9.6.(1), or

b) the piping is *combustible* and the penetration is sealed by a *firestop* conforming to Clause 9.10.9.6.(1)(a).

3) *Combustible* drain, waste and vent piping is permitted on one side of a vertical *fire separation*, provided it is not located in a vertical shaft.

4) In *buildings* containing two *dwelling units* only, *combustible* drain, waste and vent piping is permitted on one side of a horizontal *fire separation*.

5) Water distribution piping is permitted to partly or wholly penetrate a *fire separation* required to have a *fire-resistance rating*, provided

a) the piping is *noncombustible* and the penetration is protected in accordance with Sentence 9.10.9.6.(1), or

b) the piping is *combustible* and is not located in a vertical shaft, and the penetration is sealed by a *firestop* conforming to Clause 9.10.9.6.(1)(a).

#### **9.10.9.8. Penetrations by Outlet Boxes or Service Equipment in Concealed Spaces**

1) Except as provided in Sentences (2) to (5), outlet boxes are permitted to penetrate the membrane of an assembly required to have a *fire-resistance rating*, provided they are sealed at the penetration by a *firestop* that, when subjected to the fire test method in CAN/ULC-S115, "Standard Method of Fire Tests of Firestop Systems," has an FT rating not less than the *fire-resistance rating* of the *fire separation*. (See Note A-9.10.9.8.(1).)

2) Except as provided in Sentence 9.10.9.6.(2), *noncombustible* outlet boxes that penetrate a *fire separation* or a membrane forming part of an assembly required to have a *fire-resistance rating* need not conform to Sentence (1), provided

a) they do not exceed

i) 0.016 m<sup>2</sup> in area, and

ii) an aggregate area of 0.065 m<sup>2</sup> in any 9.3 m<sup>2</sup> of surface area, and

b) the annular space between the membrane and the *noncombustible* outlet boxes does not exceed 3 mm.

3) Except as provided in Sentence 9.10.9.6.(2), *combustible* outlet boxes that penetrate a *fire separation* or a membrane forming part of an assembly required to have a *fire-resistance rating* need not conform to Sentence (1), provided

a) the outlet boxes are

i) separated from the remainder of the space within the assembly by an enclosure of not more than 0.3 m<sup>2</sup> in area made of *fire block* material conforming to Article 9.10.16.3. (see Note A-9.10.9.8.(3)(a)(i)), or

ii) located in a space within the assembly that is filled with preformed fibre insulation processed from rock or slag conforming to CAN/ULC-S702.1, "Standard for Mineral Fibre Thermal Insulation for Buildings, Part 1: Material Specification," and having a mass per unit area of not less than 1.22 kg/m<sup>2</sup> of wall surface such that the exposed sides and back of the outlet box are encapsulated by the *noncombustible* insulation, and

b) the outlet boxes do not exceed an aggregate area of 0.016 m<sup>2</sup> in any individual enclosure as described in Subclause (a)(i) or any individual insulated space as described in Subclause (a)(ii).

4) *Noncombustible* outlet boxes conforming to Sentence (2) are permitted to be located on opposite sides of a vertical *fire separation* having a *fire-resistance rating* and need not conform to Sentence (1), provided they are

a) separated from each other by a horizontal distance of not less than 600 mm,

b) separated from each other and the remainder of the wall space by an enclosure conforming to Subclause (3)(a)(i), or

c) located in an insulated wall space in accordance with Subclause (3)(a)(ii).

5) *Combustible* outlet boxes conforming to Sentence (3) are permitted to be located on opposite sides of a vertical *fire separation* having a *fire-resistance rating* and need not conform to Sentence (1).

6) Service equipment is permitted to penetrate a horizontal *fire separation* conforming to Sentence 9.10.9.12.(2), provided the penetration is sealed by

a) a *firestop* that, when subjected to the fire test method in CAN/ULC-S115, "Standard Method of Fire Tests of Firestop Systems," has an FT rating not less than the required *fire-resistance rating* for the *fire separation*,

b) a *firestop* conforming to Clause 9.10.9.6.(1)(a), where the service equipment is located entirely within the cavity of a wall assembly above and below the horizontal *fire separation* having a required *fire-resistance rating*, or

c) a *firestop* conforming to Clause 9.10.9.6.(1)(a), where the penetration is

- i) contained within the concealed space of a floor or ceiling assembly having a *fire-resistance rating*,
- ii) located above a ceiling membrane providing a horizontal *fire separation*, or
- iii) contained within a *horizontal service space* conforming to Sentence 9.10.9.12.(2) that is directly above or below a floor or ceiling.

#### **9.10.9.9. Penetrations by Raceways, Sprinklers and Fire Dampers**

- 1) *Combustible* totally enclosed raceways that are embedded in a concrete floor slab are permitted in an assembly required to have a *fire-resistance rating*, provided the concrete cover between the raceway and the bottom of the slab is not less than 50 mm.
- 2) Totally enclosed raceways are permitted to penetrate a *fire separation*, provided they are sealed at the penetration by a *firestop* conforming to Clause 9.10.9.6.(1)(a).
- 3) Sprinkler piping is permitted to penetrate a *fire separation*, provided the *fire compartments* on each side of the *fire separation* are *sprinklered*.
- 4) Sprinklers are permitted to penetrate a *fire separation* or a membrane forming part of an assembly required to have a *fire-resistance rating* without having to meet the *firestop* requirements of Article 9.10.9.6. and Clause 9.10.9.8.(6)(a), provided the annular space created by the penetration of a fire sprinkler is covered by a metal escutcheon plate in accordance with NFPA 13, "Standard for the Installation of Sprinkler Systems."
- 5) *Fire dampers* are permitted to penetrate a *fire separation* or a membrane forming part of an assembly required to have a *fire-resistance rating* without having to meet the *firestop* requirements of Sentence 9.10.9.6.(1), provided the *fire damper* is
  - a) installed in conformance with NFPA 80, "Standard for Fire Doors and Other Opening Protectives,"
  - b) specifically designed with a *firestop*, or
  - c) provided in conformance with Sentence 9.10.5.1.(3).
 (See also Note A-3.1.9.2.(1).)
- 6) In a single detached house, ducts penetrating *fire separations* need not be equipped with *fire dampers* in conformance with Article 3.1.8.10. provided they are *noncombustible* with all openings in the duct system serving only one *fire compartment*.

#### **9.10.9.10. Collapse of Combustible Construction**

- 1) *Combustible construction* that abuts on or is supported by a *noncombustible fire separation* shall be constructed so that its collapse under fire conditions will not cause collapse of the *fire separation*.

#### **9.10.9.11. Reduction in Thickness of Fire Separation by Beams and Joists**

- 1) Where pockets for the support of beams or joists are formed in a masonry or concrete *fire separation*, the remaining total thickness of masonry and/or grout and/or concrete shall be not less than the required equivalent thickness shown for Type S monolithic concrete in Table D-2.1.1. of Appendix D for the required *fire-resistance rating*.

#### **9.10.9.12. Concealed Spaces above Fire Separations**

- 1) Except as provided in Sentence (2), a *horizontal service space* or other concealed space located above a required vertical *fire separation* shall be divided at the *fire separation* by an equivalent *fire separation* within the space.

2) Where a *horizontal service space* or other concealed space is located above a required vertical *fire separation* other than a vertical shaft, such space need not be divided as required in Sentence (1) provided the construction between such space and the space below is constructed as a *fire separation* having a *fire-resistance rating* not less than that required for the vertical *fire separation*, except that where the vertical *fire separation* is not required to have a *fire-resistance rating* greater than 45 min, the *fire-resistance rating* of the ceiling may be reduced to 30 min.

#### **9.10.9.13. Separation of Residential Occupancies**

1) Except as provided in Sentence (2), *residential occupancies* shall be separated from all other *major occupancies* by a *fire separation* having a *fire-resistance rating* of not less than 1 h.

2) Except as provided in Sentence (3), a *major occupancy* classified as a *residential occupancy* shall be separated from other *major occupancies* classified as *mercantile* or *medium-hazard industrial occupancies* by a *fire separation* having a *fire-resistance rating* of not less than 2 h.

3) Where not more than two *dwelling units* are located in a *building* containing a *mercantile occupancy*, such *mercantile occupancy* shall be separated from the *dwelling units* by a *fire separation* having not less than 1 h *fire-resistance rating*.

#### **9.10.9.14. Residential Suites in Industrial Buildings**

1) Not more than one *suite* of *residential occupancy* shall be contained within a *building* classified as a Group F, Division 2 *major occupancy*.

#### **9.10.9.15. Separation of Suites**

1) Except as required in Article 9.10.9.16. and as permitted by Sentence (2), each *suite* in other than *business and personal services occupancies* shall be separated from adjoining *suites* by a *fire separation* having a *fire-resistance rating* of not less than 45 min.

2) In *sprinklered buildings*, *suites* of *business and personal services occupancy* and *mercantile occupancy* that are served by *public corridors* conforming with Clause 3.3.1.4.(4)(b) are not required to be separated from each other by *fire separations*.

#### **9.10.9.16. Separation of Residential Suites**

1) Except as provided in Sentences (2) to (5) and Article 9.10.21.2., *suites* in *residential occupancies* shall be separated from adjacent rooms and *suites* by a *fire separation* having a *fire-resistance rating* of not less than 45 min.

2) Sleeping rooms in boarding and lodging houses where sleeping accommodation is provided for not more than 8 boarders or lodgers need not be separated from the remainder of the *floor area* as required in Sentence (1) where the sleeping rooms form part of the proprietor's residence and do not contain cooking facilities.

3) Except as provided in Sentences (4) and (5), *dwelling units* that contain 2 or more *storeys* including *basements* as well as principal dwelling units including subordinate ancillary residential units and common spaces shall be separated from the remainder of the *building* by a *fire separation* having a *fire-resistance rating* of not less than 1 h. (See Note A-3.3.4.4.(1).)

4) Except as permitted in Sentence (5), in a single detached house, *dwelling units* shall be separated from each other and from ancillary spaces and common spaces with a *fire separation*

a) having a *fire-resistance rating* not less than 15 min when all *smoke alarms* within the single detached house are of photo-electric type and interconnected as described in Clause 9.10.19.5.(2)(a) (see also Sentence 9.10.3.1.(2)),

b) having a *fire-resistance rating* not less than 30 min when additional *smoke alarms* of photo-electric type are installed and interconnected as described in Clause 9.10.19.5.(2)(b) (see also Sentence 9.10.3.1.(3)),

c) having a *fire-resistance rating* not less than 45 min when *smoke alarms* are not installed and interconnected as described in Clauses (a) or (b), or

d) that is not required to have a *fire-resistance rating* if the *building* is *sprinklered*.

5) The *fire separation* required by Sentence (4), between the principal *dwelling unit* and a subordinate *ancillary residential unit*, in a *sprinklered building* may be constructed as

a) wall or partition assembly consisting of

i) not less than one layer of 1/2" type C or 5/8" type X wall board on wood or steel studs on each side,

ii) resilient channel installed on at least one side, and

iii) *noncombustible* insulation of at least 3-1/2" depth throughout, and

b) floor assemblies consisting of

i) not less than one layer of 1/2" type C or 5/8" type X wall board,

ii) with resilient channel, and

iii) at least 3-1/2" of *noncombustible* insulation.

#### **9.10.9.17. Separation of Public Corridors**

1) Except as otherwise required by this Part and as provided in Sentences (2) to (5), *public corridors* shall be separated from the remainder of the *building* by a *fire separation* having not less than a 45 min *fire-resistance rating*.

2) In other than *residential occupancies*, no *fire-resistance rating* is required for *fire separations* between a *public corridor* and the remainder of the *building* if

a) the *floor area* is *sprinklered*,

b) the sprinkler system is electrically supervised in conformance with Sentence 3.2.4.9.(3), and

c) the operation of the sprinkler system will cause a signal to be transmitted to the fire department in conformance with Sentence 3.2.4.7.(4).

3) In other than *residential occupancies*, no *fire separation* is required between a *public corridor* and the remainder of the *building* if

a) the *floor area* is *sprinklered*,

b) the sprinkler system is electrically supervised in conformance with Sentence 3.2.4.9.(3),

c) the operation of the sprinkler system will cause a signal to be transmitted to the fire department in conformance with Sentence 3.2.4.7.(4), and

d) the corridor exceeds 5 m in width.

4) A *public corridor* located in a single detached house shall be separated from the remainder of the spaces in the house with a *fire separation*

a) having a *fire-resistance rating* not less than 15 min when all *smoke alarms* within the house are of photo-electric type and interconnected as described in Clause 9.10.19.5.(2)(a) (see also Sentence 9.10.3.1.(2)),

b) having a *fire-resistance rating* not less than 30 min when additional *smoke alarms* of photo-electric type are installed and interconnected as described in Clause 9.10.19.5.(2)(b) (see also Sentence 9.10.3.1.(3)),

c) having a *fire-resistance rating* not less than 45 min when *smoke alarms* are not installed and interconnected as described in Clauses (a) or (b), or

d) that is not required to have a *fire-resistance rating* if the *building* is *sprinklered*.

5) No *fire separation* is required in a *sprinklered floor area* between a *public corridor* and a space containing plumbing fixtures required by Article 3.7.2.2. and Section 9.31., provided

a) the space and the *public corridor* are separated from the remainder of the *storey* by a *fire separation* having a *fire-resistance rating* not less than that required between the *public corridor* and the remainder of the *storey*, and

b) the plumbing fixtures are not located within a *dwelling unit* or *suite*.

#### **9.10.9.18. Separation of Storage Garages**

1) Except as provided in Sentences (2) and (3), a *storage garage* shall be separated from other *occupancies* by a *fire separation* having not less than a 1.5 h *fire-resistance rating*.

2) Except as permitted in Sentence (3), *storage garages* containing 5 motor vehicles or fewer shall be separated from other *occupancies* by a *fire separation* of not less than 1 h.

3) Where a *storage garage* serves only the *dwelling unit* to which it is attached or in which it is built, it shall be considered as part of that *dwelling unit* and the *fire separation* required in Sentence (2) need not be provided between the garage and the *dwelling unit*.

4) Except as provided in Sentence (5), where a *storage garage* is attached to or built into a *building* of *residential occupancy*,

a) an *air barrier system* conforming to Subsection 9.25.3. shall be installed between the garage and the remainder of the *building* to provide an effective barrier to gas and exhaust fumes, and

b) every door between the garage and the remainder of the *building* shall conform to Article 9.10.13.15.

(See Note A-9.10.9.18.(4).)

5) Where membrane materials are used to provide the required airtightness in the *air barrier system*, all joints shall be sealed and structurally supported.

#### **9.10.9.19. Separation of Repair Garages**

1) Except as provided in Sentences (2) and (3), a *repair garage* shall be separated from other *occupancies* by a *fire separation* having a *fire-resistance rating* of not less than 2 h.

2) Ancillary spaces directly serving a *repair garage*, including waiting rooms, reception rooms, tool and parts storage areas and supervisory office space, need not be separated from the *repair garage* but shall be separated from other *occupancies* as required in Sentence (1).

3) The *fire separation* referred to in Sentence (1) shall have a *fire-resistance rating* of not less than 1 h, where

a) the *building* is not more than one *storey* in *building height*,



- b) the *building* is operated as a single *suite*, and
- c) the only *occupancy* other than the *repair garage* is a *mercantile occupancy*.

4) Except as provided in Sentence (5), where a *building* containing a *repair garage* also contains a *dwelling unit*, an *air barrier system* conforming to Subsection 9.25.3. shall be installed between the *dwelling unit* and the *suite* containing the garage to provide an effective barrier to gas and exhaust fumes. (See Note A-9.10.9.18.(4).)

5) Where membrane materials are used to provide the required airtightness in the *air barrier system*, all joints shall be sealed and structurally supported.

#### **9.10.9.20. Exhaust Ducts Serving More Than One Fire Compartment**

1) Where a *vertical service space* contains an *exhaust duct* that serves more than one *fire compartment*, the duct shall have a fan located at or near the exhaust outlet to ensure that the duct is under negative pressure.

2) Individual *fire compartments* referred to in Sentence (1) shall not have fans that exhaust directly into the duct in the *vertical service space*.

#### **9.10.9.21. Central Vacuum Systems**

- 1) A central vacuum system shall serve not more than one *suite*.

### **9.10.10. Service Rooms**

#### **9.10.10.1. Application**

1) This Subsection applies to *service rooms* in all *buildings* except rooms located within a *dwelling unit*.

#### **9.10.10.2. Service Room Floors**

1) The *fire-resistance rating* requirements in this Subsection do not apply to the floor assembly immediately below a *service room*.

#### **9.10.10.3. Separation of Service Rooms**

1) Except as provided in Sentence (2) and Articles 9.10.10.5. and 9.10.10.6., *service rooms* shall be separated from the remainder of the *building* by a *fire separation* having a *fire-resistance rating* of not less than 1 h when the *floor area* containing the *service room* is not *sprinklered*.

2) Where a room contains a limited quantity of service equipment and the service equipment does not constitute a fire hazard, the requirements in Sentence (1) shall not apply.

#### **9.10.10.4. Location of Fuel-Fired Appliances**

1) Except as provided in Sentences (2) and (3) and Article 9.10.10.5., fuel-fired *appliances* shall be located in a *service room* separated from the remainder of the *building* by a *fire separation* having not less than a 1 h *fire-resistance rating*.

2) Except as required in the *appliance* installation standards referenced in Sentences 6.2.1.5.(1), 9.33.5.2.(1) and 9.33.5.3.(1), fuel-fired *space-heating appliances*, *space-cooling appliances*, *service water heaters* and *laundry appliances* need not be separated from the remainder of the *building* as required in Sentence (1),

- a) where the *appliances* serve
  - i) not more than one room or *suite*, or
  - ii) a *building* with a *building area* of not more than 400 m<sup>2</sup> and a *building height* of not more than 2 *storeys*, or

- b) where the *appliances*
  - i) serve a single detached house, and
  - ii) are located in a *service room* separated from the *dwelling units* or their common spaces by a *fire separation* having a *fire-resistance rating* not less than the *fire-resistance rating* required for the *fire separation* between the *dwelling units* or common spaces.
- 3) Sentence (1) does not apply to fireplaces and cooking *appliances*.

#### **9.10.10.5. Incinerators**

- 1) *Service rooms* containing incinerators shall be separated from the remainder of the *building* by a *fire separation* having a *fire-resistance rating* of not less than 2 h.
- 2) The design, construction, installation and *alteration* of each indoor incinerator shall conform to NFPA 82, "Standard on Incinerators and Waste and Linen Handling Systems and Equipment."
- 3) Every incinerator shall be connected to a *chimney flue* conforming to the requirements in Section 9.21. and serving no other *appliance*.
- 4) An incinerator shall not be located in a room with other fuel-fired *appliances*.

#### **9.10.10.6. Storage Rooms**

- 1) Rooms for the temporary storage of *combustible* refuse and materials for recycling in all *occupancies* or for public storage in *residential occupancies* shall be separated from the remainder of the *building* by a *fire separation* having not less than a 1 h *fire-resistance rating*, except that a *fire separation* with a *fire-resistance rating* of not less than 45 min is permitted where
- a) the *fire-resistance rating* of the floor assembly is not required to exceed 45 min, or
  - b) the room is *sprinklered*.

#### **9.10.11. Firewalls**

##### **9.10.11.1. Required Firewalls**

- 1) Except as provided in Article 9.10.11.2., a *party wall* on a property line shall be constructed as a *firewall*. (See Note A-3.2.3.4.(1).)

##### **9.10.11.2. Firewalls Not Required**

- 1) A *party wall* on a property line of a *building* of *residential occupancy* need not be constructed as a *firewall*, provided it is constructed as a *fire separation* having not less than a 1 h *fire-resistance rating*, where the *party wall* separates
- a) two principal *dwelling units* where there is no principal *dwelling unit* above another,
  - b) ~~deleted~~, or
  - c) principal *dwelling units* and common spaces in a duplex.
- 2) Reserved.
- 3) The wall described in Sentence (1) shall provide continuous protection from the top of the footings to the underside of the roof deck.

- 4) Any space between the top of the wall described in Sentence (1) and the roof deck shall be tightly filled with mineral wool or *noncombustible* material.

##### **9.10.11.3. Construction of Firewalls**

- 1) Where *firewalls* are used, the requirements in Part 3 shall apply.

## **9.10.12. Prevention of Fire Spread at Exterior Walls and between Storeys**

### **9.10.12.1. Termination of Floors or Mezzanines**

1) Except as provided in Sentence (2) and in Articles 9.10.1.3. and 9.10.9.5., the portions of a *floor area* or *mezzanine* that do not terminate at an exterior wall, a *firewall* or a vertical shaft, shall terminate at a vertical *fire separation* having a *fire-resistance rating* not less than that required for the floor assembly that terminates at the separation.

2) A *mezzanine* need not terminate at a vertical *fire separation* where the *mezzanine* is not required to be considered as a *storey* in Articles 9.10.4.1. and 9.10.4.2.

### **9.10.12.2. Location of Skylights**

1) Where a wall in a *building* is exposed to a fire hazard from an adjoining roof of a separate *fire compartment* that is not *sprinklered* in the same *building*, the roof shall contain no skylights within a horizontal distance of 5 m of the windows in the exposed wall.

### **9.10.12.3. Exterior Walls Meeting at an Angle**

1) Except as provided in Article 9.9.4.5., where exterior walls of a *building* meet at an external angle of 135° or less, the horizontal distance from an *unprotected opening* in one exterior wall to an *unprotected opening* in the other exterior wall shall be not less than 1.2 m, where these openings are

- a) in different *fire compartments*, or
- b) in different *dwelling units*, ancillary spaces or common spaces in a single detached house.

2) The exterior wall of each *fire compartment* referred to in Sentence (1) within the 1.2 m distance shall have a *fire-resistance rating* not less than that required for the interior vertical *fire separation* between the compartment and the remainder of the *building*.

3) Reserved.

### **9.10.12.4. Protection of Soffits**

1) This Article applies to the portion of any soffit enclosing a projection that is

- a) less than 2.5 m vertically above a window or door, and
- b) less than 1.2 m from either side of the window or door.

(See Note A-9.10.12.4.(1).)

2) Except as provided in Sentences (4) and (5), the construction described in Sentence (1) shall have no *unprotected openings* and shall be protected in accordance with Sentence (3), where the soffit encloses

- a) a common *attic* or *roof space* that spans more than 2 *suites* of *residential occupancy* and projects beyond the exterior wall of the *building*,
- b) a floor space where an upper *storey* projects beyond the exterior wall of a lower *storey* and
  - i) a *fire separation* is required at the floor between the two, or
  - ii) reserved, or
- c) a floor space where an upper *storey* projects beyond the exterior wall of a lower *storey*, and the projection is continuous across
  - i) a vertical *fire separation* separating two *suites*, or

- ii) reserved.
- 3) Protection required by Sentence (2) shall be provided by
  - a) *noncombustible* material having a minimum thickness of 0.38 mm and a melting point not below 650°C,
  - b) not less than 12.7 mm thick gypsum soffit board or gypsum board installed according to CSA A82.31-M, "Gypsum Board Application,"
  - c) not less than 11 mm thick plywood,
  - d) not less than 12.5 mm thick OSB or waferboard, or
  - e) not less than 11 mm thick lumber.

(See Note A-9.10.12.4.(3).)

4) In the case of a soffit described in Sentence (1) that is at the edge of an *attic or roof space* and completely separated from the remainder of that *attic or roof space* by *fire blocks*, the requirements in Sentence (2) do not apply.

5) Where all *suites* spanned by a common *attic or roof space* or situated above or below the projecting floor are *sprinklered*, the requirements of Sentence (2) do not apply, provided that all rooms, including closets and bathrooms, having openings in the wall beneath the soffit are *sprinklered*, notwithstanding any exceptions in the sprinkler standards referenced in Article 3.2.5.12.

### **9.10.13. Doors, Dampers and Other Closures in Fire Separations**

#### **9.10.13.1. Closures**

1) Except as provided in Article 9.10.13.2., openings in required *fire separations* shall be protected with a *closure* conforming to Table 9.10.13.1. and shall be installed in conformance with Chapters 2 to 14 of NFPA 80, "Standard for Fire Doors and Other Opening Protectives," unless otherwise specified herein. (See also Article 9.10.3.1.)

Table 9.10.13.1.

Fire-Protection Ratings for Closures

#### **Forming Part of Sentence 9.10.13.1.(1)**

<b>Required Fire-Resistance Rating of Fire Separation<sup>1</sup></b>	<b>Minimum Fire-Protection Rating of Closure</b>
30 or 45 min	20 min <sup>(1)</sup>
1 h	45 min <sup>(1)</sup>
1.5 h	1 h
2 h	1.5 h
3 h	2 h
4 h	3 h

Notes to Table 9.10.13.1.:

<sup>(1)</sup> See Article 9.10.13.2.

#### **9.10.13.2. Solid Core Wood Door as a Closure**

1) A 45 mm thick solid core wood door is permitted to be used where a minimum *fire-protection rating* of 20 min is permitted between an *ancillary residential unit* and its principal

*dwelling unit* or between a *public corridor* and a *suite* provided that the door conforms to CAN/ULC-S113, "Standard Specification for Wood Core Doors Meeting the Performance Required by CAN/ULC-S104 for Twenty Minute Fire Rated Closure Assemblies." (See Note A-9.10.13.2.(1).)

2) Doors described in Sentence (1) shall have not more than a 6 mm clearance beneath and not more than 3 mm at the sides and top.

#### **9.10.13.3. Unrated Wood Door Frames**

1) Doors required to provide a 20 min *fire-protection rating* or permitted to be 45 mm solid core wood shall be mounted in a wood frame of not less than 38 mm thickness where the frame has not been tested and rated.

#### **9.10.13.4. Doors as a Means of Egress**

1) Doors forming part of an *exit* or a *public means of egress* shall conform to Subsection 9.9.6. in addition to this Subsection.

#### **9.10.13.5. Wired Glass as a Closure**

1) Wired glass conforming to Article 9.6.1.2. which has not been tested in accordance with Article 9.10.3.1. is permitted as a *closure* in a vertical *fire separation* required to have a *fire-resistance rating* of not more than 1 h provided such glass is not less than 6 mm thick and is mounted in conformance with Sentence (2).

2) Wired glass described in Sentence (1) shall be mounted in fixed steel frames having a metal thickness of not less than 1.35 mm and a glazing stop of not less than 20 mm on each side of the glass.

3) Individual panes of glass described in Sentence (1) shall not exceed 0.8 m<sup>2</sup> in area or 1.4 m in height or width, and the area of glass not structurally supported by mullions shall not exceed 7.5 m<sup>2</sup>.

#### **9.10.13.6. Steel Door Frames**

1) Steel door frames forming part of a *closure* in a *fire separation*, including anchorage requirements, shall conform to CAN/ULC-S105, "Standard Specification for Fire Door Frames Meeting the Performance Required by CAN/ULC-S104."

#### **9.10.13.7. Glass Block as a Closure**

1) Glass block that has not been tested in accordance with Article 9.10.3.1. is permitted as a *closure* in a *fire separation* required to have a *fire-resistance rating* of not more than 1 h. (See Article 9.20.9.6.)

#### **9.10.13.8. Maximum Size of Opening**

1) The size of an opening in an interior *fire separation*, even where protected with a *closure*, shall not exceed 11 m<sup>2</sup>, with no dimension greater than 3.7 m, when the *fire compartments* on both sides of the *fire separation* are not *sprinklered*.

2) The size of an opening in an interior *fire separation*, even where protected with a *closure*, shall not exceed 22 m<sup>2</sup>, with no dimension greater than 6 m, when the *fire compartments* on both sides of the *fire separation* are *sprinklered*.

#### **9.10.13.9. Door Latch**

1) Every swing type door in a *fire separation* shall be equipped with a latch.

#### **9.10.13.10. Self-closing Device**

1) Except as described in Sentence (2), every door in a *fire separation* shall have a self-closing device.

2) Self-closing doors are not required between *public corridors* and *suites in business and personal services occupancies*, except in dead-end corridors.

#### **9.10.13.11. Hold-Open Devices**

1) Where hold-open devices are used on doors in required *fire separations*, they shall be installed in accordance with Article 3.1.8.14.

#### **9.10.13.12. Service Room Doors**

1) Swing-type doors shall open into *service rooms* containing fuel-fired equipment where such doors lead to *public corridors* or rooms used for assembly but shall swing outward from such rooms in all other cases.

#### **9.10.13.13. Fire Dampers**

1) Except as permitted by Sentences (2) to (5), 9.10.5.1.(3) and 9.10.9.9.(5), a duct that penetrates an assembly required to be a *fire separation* with a *fire-resistance rating* shall be equipped with a *fire damper* in conformance with Articles 3.1.8.4. and 3.1.8.10.

2) A *fire damper* is not required where a *noncombustible* branch duct pierces a required *fire separation* provided the duct

a) has a melting point not below 760°C,

b) has a cross-sectional area less than 130 cm<sup>2</sup>, and

c) supplies only air-conditioning units or combined air-conditioning and heating units discharging air at not more than 1.2 m above the floor.

3) A *fire damper* is not required where a *noncombustible* branch duct pierces a required *fire separation* around an *exhaust duct* riser in which the airflow is upward provided

a) the melting point of the branch duct is not below 760°C,

b) the branch duct is carried up inside the riser not less than 500 mm, and

c) the *exhaust duct* is under negative pressure as described in Article 9.10.9.20.

4) *Noncombustible* ducts that penetrate a *fire separation* separating a *vertical service space* from the remainder of the *building* need not be equipped with a *fire damper* at the *fire separation* provided

a) the ducts have a melting point above 760°C, and

b) each individual duct exhausts directly to the outside at the top of the *vertical service space*.

5) A duct serving commercial cooking equipment and piercing a required *fire separation* need not be equipped with a *fire damper* at the *fire separation*. (See also Article 6.3.1.6.)

#### **9.10.13.14. Fire Stop Flaps**

1) *Fire stop flaps* in ceiling membranes referred to in Sentence 9.10.5.1.(3) shall

a) conform to CAN/ULC-S112.2, "Standard Method of Fire Test of Ceiling Firestop Flap Assemblies," and

b) activate at a temperature approximately 30°C above the normal maximum temperature that occurs in the ducts, whether the air duct system is operating or shut down.

#### **9.10.13.15. Doors between Garages and Dwelling Units**

1) A door between an attached or built-in garage and a *dwelling unit* shall be tight fitting and weather-stripped to provide an effective barrier against the passage of gas and exhaust fumes and shall be fitted with a self-closing device.

2) A doorway between an attached or built-in garage and a *dwelling unit* shall not be located in a room intended for sleeping.

#### **9.10.13.16. Door Stops**

1) Where a door is installed so that it may damage the integrity of a *fire separation* if its swing is unrestricted, door stops shall be installed to prevent such damage.

### **9.10.14. Spatial Separation Between Buildings**

#### **9.10.14.1. Application**

1) This Subsection applies to *buildings* other than those to which Subsection 9.10.15. applies.

2) This Subsection does not apply to detached carports conforming to Section 9.35. that serve not more than one principal *dwelling unit*.

#### **9.10.14.2. Area and Location of Exposing Building Face**

1) Except as permitted by Sentence (4), the area of an *exposing building face* shall be

a) taken as the exterior wall area facing in one direction on any side of a *building*, and

b) calculated as

i) the total area measured from the finished ground level to the uppermost ceiling, or

ii) the area for each *fire compartment*, where a *building* is divided into *fire compartments* by *fire separations* with *fire-resistance ratings* not less than 45 min.

2) For the purpose of using Table 9.10.14.4.-A to determine the maximum aggregate area of *unprotected openings* in an irregularly shaped or skewed exterior wall, the location of the *exposing building face* shall be taken as a vertical plane located so that there are no *unprotected openings* between the vertical plane and the line to which the *limiting distance* is measured. (See Note A-3.2.3.1.(4).)

3) For the purpose of using Table 9.10.14.5.-A to determine the required type of construction, cladding and *fire-resistance rating* for an irregularly shaped or skewed exterior wall,

a) the location of the *exposing building face* shall be taken as a vertical plane located so that no portion of the actual *exposing building face* is between the vertical plane and the line to which the *limiting distance* is measured, and

b) the value for the maximum area of *unprotected openings* (see second column of Table 9.10.14.5.-A) shall be determined using the *limiting distance* measured from the location described in Clause (a). (See Note A-3.2.3.1.(4).)

4) If a *building* is divided by *fire separations* into *fire compartments*, the area of *exposing building face* is permitted to be calculated for each *fire compartment*, provided the *fire separations* have a *fire-resistance rating* not less than 45 min.

#### **9.10.14.3. Limiting Distance and Fire Department Response**

1) Except for the purpose of applying Sentences 9.10.14.4.(2), (3), (8) and (9), and Sentences 9.10.14.5.(3), (8) and (13), a *limiting distance* equal to half the actual *limiting distance* shall be used as input to the requirements of this Subsection, where

a) the time from receipt of notification of a fire by the fire department until the first fire department vehicle arrives at the *building* exceeds 10 min in 10% or more of all calls to the *building*, and

b) any *storey* in the *building* is not *sprinklered*.

(See Notes A-3.2.3. and A-3.2.3.1.(8).)

**9.10.14.4. Openings in Exposing Building Face**

1) Except as provided in Sentences (6) to (10), the maximum aggregate area of *unprotected openings* in an *exposing building face* shall

a) conform to Table 9.10.14.4.-A,

b) conform to Subsection 3.2.3., or

c) where the *limiting distance* is not less than 1.2 m, be equal to or less than

i) the *limiting distance* squared, for *residential occupancies, business and personal services occupancies* and *low-hazard industrial occupancies*, and

ii) half the *limiting distance* squared, for *mercantile occupancies* and *medium-hazard industrial occupancies*.

**Table 9.10.14.4.-A**

**Maximum Aggregate Area of Unprotected Openings in Exterior Walls(1)**

**Forming Part of Sentence 9.10.14.4.(1)**

Occupancy Classification of Building	Maximum Total Area of Exposing Building Face, m <sup>2</sup>	Maximum Aggregate Area of <i>Unprotected Openings</i> , % of <i>Exposing Building Face Area</i>												
		<i>Limiting Distance</i> , m												
		Less than 1.2	1.2	1.5	2.0	4.0	6.0	8.0	10.0	12.0	16.0	20.0	25.0	
<i>Residential, business and personal services, and low-hazard industrial</i>	30	0	7	9	12	39	88	100	—	—	—	—	—	
	40	0	7	8	11	32	69	100	—	—	—	—	—	
	50	0	7	8	10	28	57	100	—	—	—	—	—	
	100	0	7	8	9	18	34	56	84	100	—	—	—	
	Over 100	0	7	7	8	12	19	28	40	55	92	100	—	
<i>Mercantile and medium-hazard industrial</i>	30	0	4	4	6	20	44	80	100	—	—	—	—	
	40	0	4	4	6	16	34	61	97	100	—	—	—	
	50	0	4	4	5	14	29	50	79	100	—	—	—	
	100	0	4	4	4	9	17	28	42	60	100	—	—	
	Over 100	0	4	4	4	6	10	14	20	27	46	70	100	

Notes to Table 9.10.14.4.-A:

(1) See also Sentences (6) and (7) to calculate the maximum permitted area of unprotected openings in sprinklered buildings or where wired glass or glass blocks are used.

2) Openings in a wall having a *limiting distance* of less than 1.2 m shall be protected by *closures*, of other than wired glass or glass block, whose *fire-protection rating* is in conformance with the *fire-resistance rating* required for the wall. (See Table 9.10.13.1.)



3) Except for *buildings* that are *sprinklered* and for openable windows having an unobstructed opening equal to 0.35 m<sup>2</sup> installed in accordance with Sentences 9.9.10.1.(1) and (2), where the *limiting distance* is 2 m or less, individual *unprotected openings* shall be no greater than

- a) the area stated in Table 9.10.14.4.-B, or
- b) where the *limiting distance* is equal to or greater than 1.2 m, the area calculated by

$$\text{Area} = 0.24(2 \times \text{LD} - 1.2)^2$$

where

Area = area of the *unprotected opening*, and

LD = *limiting distance*.

Table 9.10.14.4.-B

Maximum Concentrated Area of Unprotected Openings

**Forming Part of Sentence 9.10.14.4.(3)**

<i>Limiting Distance, m</i>	<i>Maximum Area of Individual Unprotected Openings, m<sup>2</sup></i>
1.2	0.35
1.5	0.78
2.0	1.88

4) The spacing between individual *unprotected openings* described in Sentence (3) that serve a single room or space described in Sentence (5) shall be not less than

a) 2 m horizontally of another *unprotected opening* that is on the same *exposing building face* and serves the single room or space, or

b) 2 m vertically of another *unprotected opening* that serves the single room or space, or another room or space on the same *storey*.

5) For the purpose of Sentence (4), “single room or space” shall mean

a) two or more adjacent spaces having a full-height separating wall extending less than 1.5 m from the interior face of the exterior wall, or

b) two or more stacked spaces that are on the same *storey*.

6) If a *building* is not *sprinklered*, the maximum aggregate area of *unprotected openings* is permitted to be up to twice the area determined according to Sentence (1), where the *unprotected openings* are glazed with

a) wired glass in steel frames, as described in Article 9.10.13.5., or

b) glass blocks, as described in Article 9.10.13.7.

7) Where the *building* is *sprinklered*, the maximum aggregate area of *unprotected openings* is permitted to be up to twice the area determined according to Sentence (1), provided all rooms, including closets and bathrooms, that are adjacent to the *exposing building face* and that have *unprotected openings* are *sprinklered*, notwithstanding any exemptions in the sprinkler standards referenced in Article 3.2.5.12.

8) The maximum aggregate area of *unprotected openings* in an *exposing building face* of a *storage garage* need not comply with Sentence (1), where

a) all *storeys* are constructed as *open-air storeys*, and

b) the *storage garage* has a *limiting distance* of not less than 3 m.

9) The maximum aggregate area of *unprotected openings* in an *exposing building face* of a *storey* that faces a *street* and is at the same level as the *street* need not comply with Sentence (1), where the *limiting distance* is not less than 9 m.

10) Except as provided in Sentence (11), for garages or accessory *buildings* that serve a single *dwelling unit* only and are detached from any *building*, the maximum aggregate area of glazed openings shall comply with the requirements for *unprotected openings*.

11) The limits on the area of glazed openings stated in Sentence (10) need not apply to the *exposing building face* of a detached garage or accessory *building* facing a *dwelling unit*, where

a) the detached garage or accessory *building* serves only one *dwelling unit*,

b) the detached garage or accessory *building* is located on the same property as that *dwelling unit*, and

c) the *dwelling unit* served by the detached garage or accessory *building* is the only *major occupancy* on the property.

12) Where a *building* of *residential occupancy* is *sprinklered* and the *limiting distance* is less than 1.2 m but no less than 1 m, the maximum percentage of *unprotected openings* may be 10% provided

a) the windows are glazed with tempered, wired or laminated glass, or glass block, and

b) the *exposing building face* is constructed according to Article 9.10.14.5.

**9.10.14.5. Construction of Exposing Building Face and Walls above Exposing Building Face**

1) Except as permitted in Sentences (3) to (15), each *exposing building face* and any exterior wall located above an *exposing building face* that encloses an *attic or roof space* shall be constructed in conformance with Table 9.10.14.5.-A. (See Note A-9.10.14.5.(1).) (See also Subsection 9.10.8.)

**Table 9.10.14.5.-A**

**Minimum Construction Requirements for Exposing Building Faces**

**Forming Part of Sentence 9.10.14.5.(1)**

<b>Occupancy Classification of Building or Fire Compartment</b>	<b>Maximum Area of Unprotected Openings Permitted, % of Exposing Building Face Area</b>	<b>Minimum Required Fire-Resistance Rating</b>	<b>Type of Construction Required</b>	<b>Type of Cladding Required</b>
<i>Residential, business and personal services, and low-hazard industrial</i>	0 to 10	1 h	<i>Noncombustible</i>	<i>Noncombustible</i>
	> 10 to 25	1 h	<i>Combustible or noncombustible</i>	<i>Noncombustible</i>
	>25 to 50	45 min	<i>Combustible or noncombustible</i>	<i>Noncombustible</i>
	> 50 to < 100	45 min	<i>Combustible or noncombustible</i>	<i>Combustible or noncombustible</i>
<i>Mercantile and medium-hazard industrial</i>	0 to 10	2 h	<i>Noncombustible</i>	<i>Noncombustible</i>
	>10 to 25	2 h	<i>Combustible or noncombustible</i>	<i>Noncombustible</i>

	> 25 to 50	1 h	Combustible or noncombustible	Noncombustible
	> 50 to < 100	1 h	Combustible or noncombustible	Combustible or noncombustible

2) Except as provided in Sentences (3) to (8), cladding on *exposing building faces* and exterior walls located above *exposing building faces* that enclose an *attic or roof space*, for *buildings or fire compartments* where the maximum permitted area of *unprotected openings* is more than 10% of the *exposing building face*, need not be *noncombustible* where the wall assembly complies with the requirements of Clause 3.1.5.5.(1)(b) when tested in conformance with CAN/ULC-S134, “Standard Method of Fire Test of Exterior Wall Assemblies.”

3) Except as provided in Sentences (4) to (8) and permitted by Sentence (9), cladding on *exposing building faces* and on exterior walls located above *exposing building faces* of *buildings or fire compartments* where the maximum permitted area of *unprotected openings* is more than 25% but not more than 50% of the *exposing building face* need not be *noncombustible*, where

- a) the *limiting distance* is greater than 5.0 m,
- b) the *limiting distance* is greater than 2.5 m where the area and width-to-height ratio of the *exposing building face* conform to Table 9.10.14.5.-B,
- c) the *building or fire compartment* is *sprinklered*,
- d) the cladding
  - i) conforms to Subsection 9.27.6., 9.27.7., 9.27.8. or 9.27.9.,
  - ii) is installed without furring members, or on furring not more than 25 mm thick, over gypsum sheathing at least 12.7 mm thick or over masonry, and
  - iii) after conditioning in conformance with ASTM D2898, “Standard Practice for Accelerated Weathering of Fire-Retardant-Treated Wood for Fire Testing,” has a *flame-spread rating* not greater than 25 when tested in accordance with Sentence 3.1.12.1.(2), or
- e) the cladding
  - i) conforms to Subsection 9.27.12.,
  - ii) is installed with or without furring members over a gypsum sheathing at least 12.7 mm thick or over masonry,
  - iii) has a *flame-spread rating* not greater than 25 when tested in accordance with Sentence 3.1.12.1.(2), and
  - iv) does not exceed 2 mm in thickness exclusive of fasteners, joints and local reinforcements.

**Table 9.10.14.5.-B**

**Maximum Allowable Area and Ratio of Width to Height of Exposing Building Face  
Forming Part of Sentence 9.10.14.5.(3)**

Maximum Ratio of Width to Height of <i>Exposing Building Face</i>	Maximum Area of <i>Exposing Building Face</i> , m <sup>2</sup>
1:1	88
2:1	102
3:1	129
4:1	161

4) Except as provided in Sentence (5), where a garage or accessory *building* serves one *dwelling unit* only and is detached from any *building*, or if a detached garage serves both units of a duplex with a continuous internal *fire separation*, with a *fire-resistance rating* of at least 45 minutes, from the floor slab to the roof sheathing separating the parking spaces for each unit, the *exposing building face*

a) need not conform to the minimum required *fire-resistance rating* stated in Table 9.10.14.5.-A, where the *limiting distance* is 0.6 m or more,

b) shall have a *fire-resistance rating* of not less than 45 min, where the *limiting distance* is less than 0.6 m, and

c) need not conform to the type of cladding and type of construction required by Table 9.10.14.5.-A, regardless of the *limiting distance*.

5) The requirements regarding *fire-resistance rating*, type of construction and type of cladding need not apply to the *exposing building face* of a detached garage or accessory *building* conforming to Sentence 9.10.14.5.(4) facing a single detached house or duplex, where

a) the detached garage or accessory *building* serves only one *dwelling unit*,

b) the detached garage or accessory *building* is located on the same property as that *dwelling unit*, and

c) the *dwelling unit* served by the detached garage or accessory *building* is the only *major occupancy* on the property.

6) Except as provided in Sentence (7), *combustible* projections on the exterior of a wall that are more than 1 m above ground level and that could expose an adjacent *building* to fire spread shall not be permitted within

a) 1.2 m of a property line or the centre line of a *public way*, or

b) 2.4 m of a *combustible* projection on another *building* on the same property.

7) Except as provided in Sentences (9) to (12), Sentence (6) shall not apply to

a) *buildings* containing one or two *dwelling units* only, and

b) detached garages or accessory *buildings*, where

i) the detached garage or accessory *building* serves only one *dwelling unit*,

ii) the detached garage or accessory *building* is located on the same property as that *dwelling unit*, and

iii) the *dwelling unit* served by the detached garage or accessory *building* is the only *major occupancy* on the property.

(See Note A-9.10.14.5.(7).)

8) Where *combustible* projections on an *exposing building face* are permitted by Sentence (7), are totally enclosed and constructed with solid faces, such as for fireplaces and *chimneys*, and extend within 1.2 m of a property line,

a) the construction of the face and sides of the projection shall comply with the corresponding requirements for *exposing building faces* for *limiting distances* less than 1.2 m as stated in Sentence (2) or (3), and

b) where the underside of the projection is more than 0.6 m above finished ground level, it shall be protected by

i) not less than 0.38 mm thick *noncombustible* material,

ii) unvented aluminum conforming to CAN/CGSB-93.2-M, "Prefinished Aluminum Siding, Soffits, and Fascia, for Residential Use,"

iii) not less than 12.7 mm thick gypsum soffit board or gypsum ceiling board installed according to CSA A82.31-M, "Gypsum Board Application,"

iv) not less than 11 mm thick plywood,

v) not less than 12.5 mm thick OSB or waferboard, or

vi) not less than 11 mm thick lumber.

(See Note A-9.10.14.5.(8).)

9) Except as provided in Sentence (11), where the *exposing building face* has a *limiting distance* of not more than 0.45 m, projecting roof soffits shall not be constructed above the *exposing building face*. (See Note A-3.2.3.6.(2).)

10) Except as provided in Sentence (11), where the *exposing building face* has a *limiting distance* of more than 0.45 m, the face of roof soffits shall not project to less than 0.45 m from the property line. (See Note A-3.2.3.6.(2).)

11) The face of a roof soffit is permitted to project to the property line, where it faces a *public way*. (See Note A-9.10.14.5.(11) and 9.10.15.5.(10).)

12) Where roof soffits project to less than 1.2 m from the property line, the centre line of a *public way*, or an imaginary line between two *buildings* or *fire compartments* on the same property, they shall

a) have no openings, and

b) be protected by

i) not less than 0.38 mm thick sheet steel,

ii) unvented aluminum conforming to CAN/CGSB-93.2-M, "Prefinished Aluminum Siding, Soffits, and Fascia, for Residential Use,"

iii) not less than 12.7 mm thick gypsum soffit board or gypsum ceiling board installed according to CSA A82.31-M, "Gypsum Board Application,"

iv) not less than 11 mm thick plywood,

v) not less than 12.5 mm thick OSB or waferboard, or

vi) not less than 11 mm thick lumber.

(See Note A-3.2.3.6.(2).)

13) Heavy timber and steel columns need not conform to the requirements of Sentence (1), provided the *limiting distance* is not less than 3 m.

14) Non-loadbearing wall components need not have a minimum *fire-resistance rating*, where the *building*

a) is 1 storey in *building height*,

b) is of *noncombustible construction*,

c) is classified as a *low-hazard industrial occupancy* and used only for *low fire load occupancies*, such as power-generating plants or plants for the manufacture or storage of *noncombustible* materials, and

d) has a *limiting distance* of 3 m or more.

15) Where a *residential building* is *sprinklered*, and Table 9.10.14.5.A requires *non-combustible construction*, the *exposing building faces* may use a wood stud wall assembly having a 1 hour *fire-resistance rating* provided the *limiting distance* is at least 1.0 m and the wall assembly is of *non-combustible construction* throughout excepting structural elements and sheathing.

## **9.10.15. Spatial Separation Between Houses**

**(See Note A-9.10.15.)**

### **9.10.15.1. Application**

1) This Subsection applies to

a) *residential buildings* that contain not more than two *dwelling units* and have no principal *dwelling unit* above another principal *dwelling unit*, and

b) single detached houses with an *ancillary residential unit* including their common spaces.

(See Note A-9.10.15.1.(1).)

### **9.10.15.2. Area and Location of Exposing Building Face**

1) Except as permitted by Sentence (5) the area of an *exposing building face* shall be

a) taken as the exterior wall area facing in one direction on any side of a *building*, and

b) calculated as

i) the total area measured from the finished ground level to the uppermost ceiling,

ii) **reserved**, or

iii) except as provided in Sentence (2), where Table 9.10.15.4. is used to determine the maximum aggregate area of *unprotected openings*, the area of any number of individual portions of the *exposing building face*. (See Note A-9.10.15.4.(2).)

2) Where the *exposing building face* of any section of an exterior wall enclosing a single room or space, or combination room and space, has a *limiting distance* of 2 m or less, that section of the *exposing building face* serving the room or space shall not be divided into portions for the purpose of calculating area of *exposing building face*. (See Sentence 9.10.15.4.(5) and Note A-9.10.15.4.(2).)

3) For the purpose of using Table 9.10.15.4. to determine the maximum aggregate area of *unprotected openings* in an irregularly shaped or skewed exterior wall, the location of the *exposing building face* shall be taken as a vertical plane located so that there are no *unprotected openings* between the vertical plane and the line to which the *limiting distance* is measured. (See Note A-3.2.3.1.(4).)

4) In determining the required cladding-sheathing assembly and *fire-resistance rating* for an irregularly shaped or skewed exterior wall, the location of the *exposing building face* shall be taken as a vertical plane located so that no portion of the actual *exposing building face* is between the vertical plane and the line to which the *limiting distance* is measured. (See Article 9.10.15.5. and Note A-3.2.3.1.(4).)

5) If a *building* is divided by *fire separations* into *fire compartments*, the area of *exposing building face* is permitted to be calculated for each *fire compartment* provided the *fire separations* have a *fire-resistance rating* not less than 45 min.

### **9.10.15.3. Limiting Distance and Fire Department Response**

1) Except for the purpose of applying Sentences 9.10.15.2.(2), 9.10.15.4.(3) and 9.10.15.5.(13), a *limiting distance* equal to half the actual *limiting distance* shall be used as input to the requirements of this Subsection, where

a) the time from receipt of notification of a fire by the fire department until the first fire department vehicle arrives at the *building* exceeds 10 min in 10% or more of all calls to the *building*, and

b) any *storey* in the *building* is not *sprinklered*.

(See Notes A-3.2.3. and A-3.2.3.1.(8).)

### **9.10.15.4. Glazed-Unprotected Openings in Exposing Building Face**

1) Except as provided in Sentences (6) to (11), the maximum aggregate area of *unprotected openings* in an *exposing building face* shall

a) conform to Table 9.10.15.4.,

b) conform to Subsection 3.2.3., or

c) where the *limiting distance* is not less than 1.2 m, be equal to or less than the *limiting distance* squared.

2) Where the limits on the area of *unprotected openings* are determined for individual portions of the *exposing building face*, as described in Subclause 9.10.15.2.(1)(b)(iii), the maximum aggregate area of *unprotected openings* for any portion shall be determined using the values in Table 9.10.15.4. corresponding to

a) the maximum total area of *exposing building face*, which is equal to the sum of all portions of the *exposing building face*, and

b) the *limiting distance* of each portion.

(See Note A-9.10.15.4.(2).)

3) Except for *buildings* that are *sprinklered* and for openable windows having an unobstructed opening equal to 0.35 m<sup>2</sup> installed in accordance with Sentences 9.9.10.1.(1) and (2), where the *limiting distance* is 2 m or less, individual *unprotected openings* or a group of *unprotected openings* in an *exposing building face* shall not exceed 50% of the maximum allowable aggregate area of *unprotected openings* determined in Sentence (1).

4) The spacing between individual *unprotected openings* or a group of *unprotected openings* described in Sentence (3) serving a single room or space described in Sentence (5) shall be not less than

a) 2 m horizontally of another *unprotected openings* that is on the same *exposing building face* and serves the single room or space, or

b) 2 m vertically of another *unprotected openings* that serves the single room or space, or another room or space on the same *storey*.

5) For the purpose of Sentence (4), "single room or space" shall mean

a) two or more adjacent spaces having a full-height separating wall extending less than 1.5 m from the interior face of the exterior wall, or

b) two or more stacked spaces that are on the same *storey*.

6) The limits on the area of *unprotected openings* shall not apply to the *exposing building face* of a *dwelling unit* facing a detached garage or accessory *building*, where

a) the detached garage or accessory *building* serves only one *dwelling unit*,

b) the detached garage or accessory *building* is located on the same property as that *dwelling unit*, and

c) the *dwelling unit* served by the detached garage or accessory *building* is the only *major occupancy* on the property.

7) The maximum aggregate area of *unprotected openings* in an *exposing building face* is permitted to be up to twice the area determined in accordance with Sentence (1), where

a) the *unprotected openings* consist of glass blocks, as described in Article 9.10.13.7., or

b) the *building* is *sprinklered*, provided all rooms, including closets, bathrooms and attached garages, that are adjacent to the *exposing building face* and that have *unprotected openings* are *sprinklered*, notwithstanding any exemptions in the sprinkler standards referenced in Article 3.2.5.12.

**Table 9.10.15.4.**

**Maximum Area of Glazed Openings in Exterior Walls of Houses**

**Forming Part of Subclause 9.10.15.2.(1)(b)(iii) and Sentences 9.10.15.4.(1) and (2)**

Maximum Total Area of Exposing Building Face, m <sup>2</sup>	Maximum Aggregate Area of Glazed Openings, % of Exposing Building Face Area											
	Limiting Distance, m											
	Less than 1.2	1.2	1.5	2.0	4.0	6.0	8.0	10.0	12.0	16.0	20.0	25.0
30	0	7	9	12	39	88	100	—	—	—	—	—
40	0	7	8	11	32	69	100	—	—	—	—	—
50	0	7	8	10	28	57	100	—	—	—	—	—
100	0	7	8	9	18	34	56	84	100	—	—	—
Over 100	0	7	7	8	12	19	28	40	55	92	100	—

8) If a *building* is *sprinklered* and the *limiting distance* is less than 1.2 m but not less than 1 m, the maximum centage of *unprotected openings* shall be 10% provided

a) the windows are glazed with tempered , wired, or laminated glass or glass block, and

b) the *exposing building face* is constructed according to Sentence 9.10.15.5.(14).

9) If a *building* is *sprinklered*, the maximum aggregate area of *unprotected openings* may be no more than twice the area as determined in Table 9.10.15.4. provided all rooms, including closets and bathrooms, that are adjacent to the *exposing building face* and that have *unprotected openings* shall be *sprinklered*, notwithstanding any exemptions in the sprinkler standards referenced in Article 3.2.5.12.

10) If a *storage garage* has a *limiting distance* of no less than 3 m, the *exposing building face* of such *storage garage* may have unlimited *unprotected openings*.

11) The *exposing building face* of an attached carport or open-air storage garage serving not more than 5 motor vehicles is permitted to have 100% *unprotected openings* where



a) the carport of storage garage is ancillary to a *building* of only *residential occupancy* and has a limiting distance of at least 1.2 m,

b) the perimeter walls of the carport or garage are substantially open on at least 3 sides, with not less than 25% of the total area of the exterior perimeter walls open to the exterior in a manner that will provide cross ventilation,

c) A *fire separation* is provided between the carport or storage garage and all adjacent spaces in the building with a minimum 1 h *fire-resistance rating*,

d) The garage or carport is provided with a smooth flat ceiling, and is sprinklered in accordance with the applicable sprinkler design standard and notwithstanding the provision of that standard, provided with

i) quick response sprinklers, and

ii) a minimum design density of 0.15 USgpm/sq.ft.

(see Note A-9.10.15.4.(11) )

#### **9.10.15.5. Construction of Exposing Building Face of Houses**

1) Except as provided in Sentences (4), (13) and (14), each *exposing building face* and any exterior wall located above an *exposing building face* that encloses an *attic or roof space* shall be constructed in conformance with Sentences (2) and (3)

a) for the *exposing building face* as a whole, or

b) for any number of separate portions of the *exposing building face* (see Subclause 9.10.15.2.(1)(b)(iii), Sentence 9.10.15.4.(2), and Note A-9.10.15.4.(2)).

(See also Subsection 9.10.8.)

2) Except as provided in Sentences (4) and (5), where the *limiting distance* is less than 0.6 m, the *exposing building face* and exterior walls located above the *exposing building face* that enclose an *attic or roof space* shall have a *fire-resistance rating* of not less than 45 min, and

a) the cladding shall be metal or *noncombustible* cladding installed in accordance with Section 9.20., 9.27. or 9.28. (see Note A-9.10.14.5.(1)),

b) the cladding shall

i) conform to Subsection 9.27.12.,

ii) be installed without furring members over gypsum sheathing at least 12.7 mm thick or over masonry,

iii) have a *flame-spread rating* not greater than 25 when tested in accordance with Sentence 3.1.12.1.(2), and

iv) not exceed 2 mm in thickness exclusive of fasteners, joints and local reinforcements, or

c) the wall assembly shall comply with Clause 3.1.5.5.(1)(b) when tested in conformance with CAN/ULC-S134, "Standard Method of Fire Test of Exterior Wall Assemblies."

3) Except as provided in Sentence (4), where the *limiting distance* is equal to or greater than 0.6 m and less than 1.2 m, the *exposing building face* and any exterior wall located above the *exposing building face* that encloses an *attic or roof space* shall have a *fire-resistance rating* of not less than 45 min, and

- a) the cladding shall be metal or *noncombustible* cladding installed in accordance with Section 9.20., Subsection 9.27.11. or Section 9.28. (see Note A-9.10.14.5.(1)),
  - b) the cladding shall
    - i) conform to Subsection 9.27.6., 9.27.7., 9.27.8., 9.27.9., or 9.27.10.,
    - ii) be installed without furring members, or on furring not more than 25 mm thick, over gypsum sheathing at least 12.7 mm thick or over masonry, and
    - iii) after conditioning in conformance with ASTM D2898, "Standard Practice for Accelerated Weathering of Fire-Retardant-Treated Wood for Fire Testing," have a *flame-spread rating* not greater than 25 when tested in accordance with Sentence 3.1.12.1.(2),
  - c) the cladding shall
    - i) conform to Subsection 9.27.12.,
    - ii) be installed with or without furring members over gypsum sheathing at least 12.7 mm thick or over masonry,
    - iii) have a *flame-spread rating* not greater than 25 when tested in accordance with Sentence 3.1.12.1.(2), and
    - iv) not exceed 2 mm in thickness exclusive of fasteners, joints and local reinforcements, or
  - d) the wall assembly shall comply with Clause 3.1.5.5.(1)(b) when tested in conformance with CAN/ULC-S134, "Standard Method of Fire Test of Exterior Wall Assemblies."
- 4) The requirements regarding *fire-resistance rating* and type of cladding-sheathing assembly shall not apply to the *exposing building face* or projections from an *exposing building face* of a *dwelling unit* facing a detached garage or accessory *building*, or a garage or accessory *building* facing a *dwelling unit*, where
- a) the detached garage or accessory *building* serves only one *dwelling unit*,
  - b) the detached garage or accessory *building* is located on the same property as that *dwelling unit*, and
  - c) the *dwelling unit* served by the detached garage or accessory *building* is the only *major occupancy* on the property.
- 5) Except as provided in Sentence (6), *combustible* projections on the exterior of a wall that are more than 1 m above ground level and that could expose an adjacent *building* to fire spread shall not be permitted within
- a) 1.2 m of a property line or the centre line of a *public way*, or
  - b) 2.4 m of a *combustible* projection on another *building* on the same property.
- 6) Except as provided in Sentences (8) to (11), Sentence (5) shall not apply to
- a) *buildings* containing one or two *dwelling units* only, and
  - b) detached garages or accessory *buildings*, where
    - i) the detached garage or accessory *building* serves only one *dwelling unit*,
    - ii) the detached garage or accessory *building* is located on the same property as that *dwelling unit*, and
    - iii) the *dwelling unit* served by the detached garage or accessory *building* is the only *major occupancy* on the property.

(See Note A-9.10.14.5.(7).)

7) Where *combustible* projections on an *exposing building face* are permitted by Sentence (6), are totally enclosed and constructed with solid faces, such as for fireplaces and *chimneys*, and extend within 1.2 m of a property line,

a) the construction of the face and sides of the projection shall comply with the corresponding requirements for *exposing building faces* for *limiting distances* less than 1.2 m as stated in Sentence (2) or (3), and

b) where the underside of the projection is more than 0.6 m above finished ground level, it shall be protected by

i) not less than 0.38 mm thick *noncombustible* material,

ii) unvented aluminum conforming to CAN/CGSB-93.2-M, "Prefinished Aluminum Siding, Soffits, and Fascia, for Residential Use,"

iii) not less than 12.7 mm thick gypsum soffit board or gypsum ceiling board installed according to CSA A82.31-M, "Gypsum Board Application,"

iv) not less than 11 mm thick plywood,

v) not less than 12.5 mm thick OSB or waferboard, or

vi) not less than 11 mm thick lumber.

(See Note A-9.10.14.5.(8).)

8) Except as provided in Sentence (10), where the *exposing building face* has a *limiting distance* of not more than 0.45 m, projecting roof soffits shall not be constructed above the *exposing building face*. (See Note A-3.2.3.6.(2).)

9) Except as provided in Sentence (10), where the *exposing building face* has a *limiting distance* of more than 0.45 m, the face of roof soffits shall not project to less than 0.45 m from the property line. (See Note A-3.2.3.6.(2).)

10) The face of a roof soffit is permitted to project to the property line, where it faces a *public way*. (See Note A-9.10.14.5.(11) and 9.10.15.5.(10).)

11) Where roof soffits project to less than 1.2 m from the property line, the centre line of a *public way*, or an imaginary line between two *buildings* or *fire compartments* on the same property, they shall

a) have no openings, and

b) be protected by

i) not less than 0.38 mm thick sheet steel,

ii) unvented aluminum conforming to CAN/CGSB-93.2-M, "Prefinished Aluminum Siding, Soffits, and Fascia, for Residential Use,"

iii) not less than 12.7 mm thick gypsum soffit board or gypsum ceiling board installed according to CSA A82.31-M, "Gypsum Board Application,"

iv) not less than 11 mm thick plywood,

v) not less than 12.5 mm thick OSB or waferboard, or

vi) not less than 11 mm thick lumber.

(See Note A-3.2.3.6.(2).)

12) For *buildings of combustible* construction, materials installed to provide the required protection for soffits may be covered with a *combustible* or *noncombustible* finish material.

13) Heavy timber and steel columns need not conform to the requirements of Sentence (1), provided the *limiting distance* is not less than 3 m.

14) If a *building* is *sprinklered*, and the maximum percentage of *unprotected openings* complies with Sentence 9.10.15.4.(7), the *exposing building faces* may be constructed with a wood stud wall assembly provided

a) the *exposing building face* has a one hour *fire-resistance rating*,

b) the wall assembly is of *non-combustible* construction throughout excepting structural elements and sheathing, and

c) the wall assembly is clad with *non-combustible* cladding.

## **9.10.16. Fire Blocks**

### **9.10.16.1. Required Fire Blocks in Concealed Spaces**

1) Vertical concealed spaces in interior walls and exterior walls shall be separated by *fire blocks*

a) one from the other, and

b) from horizontal concealed spaces.

2) Horizontal concealed spaces in attics, roof spaces, ceilings, floors, and crawl spaces shall be separated by *fire blocks*

a) one from the other, and

b) from vertical concealed spaces.

3) *Fire blocks* shall be provided at all interconnections between concealed vertical and horizontal spaces in interior coved ceilings, drop ceilings and soffits where the exposed construction materials within the concealed spaces have a surface *flame-spread rating* greater than 25.

4) *Fire blocks* shall be provided at the top and bottom of each run of stairs where they pass through a floor containing concealed space in which the exposed construction materials within the space have a surface *flame-spread rating* greater than 25.

5) Where not *sprinklered*, concealed spaces of *combustible construction* created by a ceiling, roof space or unoccupied attic space shall be separated by *fire blocks* into compartments

a) not more than 60 m in greatest dimension, and

b) where such space contains exposed construction materials having a surface *flame-spread rating* greater than 25, not more than 300 m<sup>2</sup> in area.

6) No dimension of the concealed space described in Clause (5)(b) shall exceed 20 m.

7) Concealed spaces in mansard or gambrel style roofs, exterior cornices, balconies and canopies of *combustible construction* in which the exposed construction materials within the space have a surface *flame-spread rating* exceeding 25 shall have vertical *fire blocks* at intervals of not more than 20 m and at points where such concealed spaces extend across the ends of required vertical *fire separations*.

### 9.10.16.2. Required Fire Blocks in Wall Assemblies

- 1) Except as permitted in Sentence (2), *fire blocks* shall be provided to block off concealed spaces within wall assemblies, including spaces created by furring,
  - a) at each floor level,
  - b) at each ceiling level where the ceiling contributes to part of the required *fire-resistance rating*, and
  - c) at other locations within the wall, so that the distance between *fire blocks* does not exceed 20 m horizontally and 3 m vertically.
- 2) *Fire blocks* described in Sentence (1) are not required, provided
  - a) the insulated wall assembly contains not more than one concealed air space whose horizontal thickness is not more than 25 mm,
  - b) the exposed construction materials within the space are *noncombustible*,
  - c) the exposed construction materials within the space, including insulation, but not including wiring, piping or similar services, have a *flame-spread rating* of not more than 25, or
  - d) the concealed wall space is filled with insulation.

### 9.10.16.3. Fire Block Materials

- 1) Except as permitted by Sentences (2) and (3), *fire blocks* shall be constructed of materials that will remain in place and prevent the passage of flames for not less than 15 min when subjected to the standard fire exposure in CAN/ULC-S101, "Standard Method of Fire Endurance Tests of Building Construction and Materials."
- 2) *Fire blocks* are deemed to comply with Sentence (1) if they are constructed of not less than
  - a) 0.38 mm sheet steel,
  - b) 12.7 mm gypsum board,
  - c) 12.5 mm plywood, OSB or waferboard, with joints having continuous supports,
  - d) two layers of lumber, each not less than 19 mm thick, with joints staggered, or
  - e) 38 mm lumber.
- 3) In a *building* permitted to be of *combustible construction*, semi-rigid fibre insulation board produced from glass, rock or slag is permitted to be used to block the vertical space in a double-frame wall assembly formed at the intersection of the floor assembly and the walls, provided the width of the vertical space does not exceed 25 mm and the insulation board
  - a) has a density not less than 45 kg/m<sup>3</sup>,
  - b) is securely fastened to one set of studs,
  - c) extends from below the bottom of the top plates in the lower *storey* to above the top of the bottom plate in the upper *storey*, and
  - d) completely fills the portion of the vertical space between the headers and between the wall plates.

(See Note A-3.1.11.7.(8).)

#### **9.10.16.4. Penetration of Fire Blocks**

1) Where *fire blocks* are pierced by pipes, ducts or other elements, the effectiveness of the *fire blocks* shall be maintained around such elements. (See also Note A-3.1.11.7.(7).)

### **9.10.17. Flame-Spread Limits**

#### **9.10.17.1. Flame-Spread Rating of Interior Surfaces**

1) Except as otherwise provided in this Subsection, the exposed surface of every interior wall and ceiling, including skylights and glazing, shall have a surface *flame-spread rating* of not more than 150.

2) Except as permitted in Sentence (3), doors need not conform to Sentence (1) provided they have a surface *flame-spread rating* of not more than 200.

3) Doors within *dwelling units*, other than garage doors, need not conform to Sentences (1) and (2).

#### **9.10.17.2. Ceilings in Exits or Public Corridors**

1) At least 90% of the exposed surface of every ceiling in an *exit* or ceiling that is not *sprinklered* in a *public corridor* shall have a surface *flame-spread rating* of not more than 25. (See Article 9.10.17.6.)

#### **9.10.17.3. Walls in Exits**

1) Except as provided in Sentence (2), at least 90% of the exposed surfaces of every wall in an *exit* shall have a surface *flame-spread rating* of not more than 25. (See Article 9.10.17.6.)

2) At least 75% of the wall surface of a lobby used as an *exit* in Article 9.9.8.5. shall have a surface *flame-spread rating* of not more than 25. (See Article 9.10.17.6.)

#### **9.10.17.4. Exterior Exit Passageways**

1) Where an exterior *exit* passageway provides the only *means of egress* from the rooms or *suites* it serves, the wall and ceiling finishes of that passageway, including the soffit beneath and the *guard* on the passageway, shall have a surface *flame-spread rating* of not more than 25, except that up to 10% of the total wall area and 10% of the total ceiling area is permitted to have a surface *flame-spread rating* of not more than 150.

#### **9.10.17.5. Walls in Public Corridors**

1) At least 90% of the total wall surface in any *public corridor* that is not *sprinklered* shall have a surface *flame-spread rating* of not more than 75, or at least 90% of the upper half of such walls shall have a surface *flame-spread rating* of not more than 25. (See Article 9.10.17.6.)

#### **9.10.17.6. Calculation of Wall and Ceiling Areas**

1) Skylights, glazing, *combustible* doors, and *combustible* light diffusers and lenses shall not be considered in the calculation of wall and ceiling areas in this Subsection.

#### **9.10.17.7. Corridors Containing an Occupancy**

1) Where a *public corridor* or a corridor used by the public contains an *occupancy*, the interior finish materials used on the walls or ceiling of such *occupancy*, shall have a surface *flame-spread rating* in conformance with that required for *public corridors*.

#### **9.10.17.8. Light Diffusers and Lenses**

1) Light diffusers and lenses having *flame-spread ratings* that exceed those permitted for the ceiling finish, shall conform to the requirements of Sentence 3.1.13.4.(1).

#### **9.10.17.9. Combustible Skylights**

1) Individual *combustible* skylights in corridors required to be separated from the remainder of the *building* by *fire separations* shall not exceed 1 m<sup>2</sup> in area and shall be spaced not less than 1.2 m apart.

#### **9.10.17.10. Protection of Foamed Plastics**

(See Note A-3.1.4.2.)

1) Except as provided in Sentences (2) and (3), foamed plastics that form part of a wall or ceiling assembly shall be protected from adjacent space in the *building*, other than adjacent concealed spaces within *attic or roof spaces*, crawl spaces, wall assemblies and ceiling assemblies

- a) by one of the interior finishes described in Subsections 9.29.4. to 9.29.9.,
- b) provided the *building* does not contain a Group C *major occupancy*, by sheet metal that
  - i) is mechanically fastened to the supporting assembly independent of the insulation,
  - ii) is not less than 0.38 mm thick, and
  - iii) has a melting point not less than 650°C, or
- c) by any thermal barrier that meets the requirements of Sentence 3.1.5.15.(2).

(See Note A-3.1.4.2.(1)(c).)

2) A walk-in cooler or freezer consisting of factory-assembled wall, floor or ceiling panels containing foamed plastics is permitted to be used, provided the panels

- a) are protected on both sides by sheet metal not less than 0.38 mm thick having a melting point not less than 650°C,
- b) do not contain an air space, and
- c) have a *flame-spread rating*, determined by subjecting a sample panel with an assembled joint typical of field installation to the applicable test described in Subsection 3.1.12., that is not more than that permitted for the room or space in which they are located or that they bound.

3) Thermosetting foamed plastic insulation having a *flame-spread rating* of not more than 200 is permitted to be used in factory-assembled doors in *storage garages* serving single *dwelling units* provided that

- a) the insulation is covered on the interior with a metallic foil,
- b) the assembly has a *flame-spread rating* of not more than 200, and
- c) the assembly incorporates no air spaces.

#### **9.10.17.11. Walls and Ceilings in Bathrooms**

1) The interior finish of walls and ceilings in bathrooms within *suites of residential occupancy* shall have a surface *flame-spread rating* of not more than 200.

#### **9.10.17.12. Coverings or Linings of Ducts**

1) Where a covering or a lining is used with a duct, such lining or covering shall have a *flame-spread rating* conforming to Article 3.6.5.4. or 9.33.6.4.

#### **9.10.18. Alarm and Detection Systems**

**9.10.18.1. Access Provided through a Firewall**

1) Where access is provided through a *firewall*, the requirements in this Subsection shall apply to the *floor areas* on both sides of the *firewall* as if they were in the same *building*.

**9.10.18.2. Fire Alarm System Required**

- 1) Except as permitted in Sentences (3) to (5), a fire alarm system shall be installed in *buildings* in which a sprinkler system is installed.
- 2) Except as provided in Sentence (5), a fire alarm system shall be installed
  - a) in every *building* that contains more than 3 *storeys*, including *storeys* below the *first storey*,
  - b) where the total *occupant load* exceeds 300, or
  - c) when the *occupant load* for any *major occupancy* in Table 9.10.18.2. is exceeded.

**Table 9.10.18.2.**

**Maximum Occupant Load for Buildings without Fire Alarm Systems**

**Forming Part of Sentence 9.10.18.2.(2)**

<i>Major Occupancy Classification</i>	<i>Occupant Load Above which a Fire Alarm System is Required</i>
<i>Residential</i>	10 (sleeping accommodation)
<i>Business and personal services, Mercantile</i>	150 above or below the <i>first storey</i>
<i>Low- or medium-hazard industrial</i>	75 above or below the <i>first storey</i>

3) In *buildings* in which a sprinkler system has been installed in accordance with NFPA 13D, “Standard for the Installation of Sprinkler Systems in One- and Two-Family Dwellings and Manufactured Homes,” a fire alarm system need not be installed.

4) In *buildings* that contain fewer than 9 sprinklers conforming to Sentence 3.2.5.12.(4), a fire alarm system need not be installed.

5) A fire alarm system is not required in a *residential occupancy* where an *exit* or *public corridor* serves not more than 4 *suites* or where each *suite* has direct access to an exterior *exit* facility leading to ground level.

**9.10.18.3. Design and Installation Requirements**

1) Except as stated in Sentence (2) and as required by this Subsection, where fire alarm, fire detection and smoke detection devices and systems are installed, these devices and systems and their installation shall conform to Subsection 3.2.4.

2) The following Articles in Subsection 3.2.4. regarding fire alarm systems do not apply to Part 9 *buildings*: Articles 3.2.4.1., 3.2.4.10., 3.2.4.11., 3.2.4.12., 3.2.4.13. and 3.2.4.22.

**9.10.18.4. Rooms and Spaces Requiring Heat Detectors or Smoke Detectors**

1) Where a fire alarm system is required, every *public corridor* in *buildings* of *residential occupancy* and every *exit* stair shaft shall be provided with *smoke detectors*.

2) Except as provided in Sentence (3), if a fire alarm system is required in a *building* that is not *sprinklered*, *fire detectors* shall be installed in the following spaces:

- a) storage rooms not within *dwelling units*,
- b) *service rooms* not within *dwelling units*,



- c) janitors' rooms
- d) rooms in which hazardous substances are to be used or stored (see Note A-3.3.1.2.(1)),
- e) elevator hoistways, chutes and dumbwaiter shafts, and
- f) laundry rooms in *buildings* of *residential occupancy*, but not those within *dwelling units*.

3) Except as required by Sentence (4), *heat detectors* and *smoke detectors* described in Sentence (2) are not required in *dwelling units* or in *sprinklered buildings* in which the sprinkler system is electrically supervised and equipped with a water flow alarm.

4) *Heat detectors* or *smoke detectors* shall be installed in any elevator hoist way or dumbwaiter shaft which is not equipped with a *sprinkler system*.

#### **9.10.18.5. Smoke Detectors in Recirculating Air-Handling Systems**

1) Except for a recirculating air system serving not more than one *dwelling unit*, where a fire alarm system is required to be installed, every recirculating air-handling system shall be designed to prevent the circulation of smoke upon a signal from a duct-type *smoke detector* where such system supplies more than one *suite* on the same floor or serves more than 1 *storey*.

#### **9.10.18.6. Portions of Buildings Considered as Separate Buildings**

1) Except as provided in Sentence (2), where a vertical *fire separation* having a *fire-resistance rating* of not less than 1 h separates a portion of a *building* from the remainder of the *building* and there are no openings through the *fire separation* other than those for piping, tubing, wiring and conduit, the requirements for fire alarm and detection systems may be applied to each portion so separated as if it were a separate *building*.

2) The permission in Sentence (1) to consider separated portions of a *building* as separate *buildings* does not apply to *service rooms* and storage rooms.

#### **9.10.18.7. Central Vacuum Systems**

1) Central vacuum cleaning systems serving more than one *suite* or *storey* in *buildings* equipped with a fire alarm system shall be designed to shut down upon activation of the fire alarm system.

#### **9.10.18.8. Open-Air Storage Garages**

1) A fire alarm system is not required in a *storage garage* conforming to Article 3.2.2.92. provided there are no other *occupancies* in the *building*.

### **9.10.19. Smoke Alarms**

#### **9.10.19.1. Required Smoke Alarms**

1) Except as permitted by Article 9.10.19.8., *smoke alarms* conforming to CAN/ULC-S531, "Standard for Smoke Alarms," shall be installed in

- a) each *dwelling unit*,
- b) each sleeping room not within a *dwelling unit*, and
- c) ancillary spaces and common spaces not in *dwelling units* in a single detached house.

#### **9.10.19.2. Sound Patterns of Smoke Alarms**

- 1) The sound patterns of *smoke alarms* shall
  - a) meet the temporal patterns of *alarm signals* (see Note A-3.2.4.18.(2)), or
  - b) be a combination of temporal pattern and voice relay.

2) All *smoke alarms* installed in *dwelling units* in unsprinklered *buildings* shall be equipped with a battery powered back up system and a wired in manually operated device which is capable of silencing a *smoke alarm* signal for a period of not more than 10 minutes and re-sounding the signal if smoke levels in the vicinity trigger the *smoke alarm*.

#### **9.10.19.3. Location of Smoke Alarms**

- 1) Within *dwelling units*, sufficient *smoke alarms* shall be installed so that
  - a) there is at least one *smoke alarm* installed on each *storey*, including *basements*, and
  - b) on any *storey* of a *dwelling unit* containing sleeping rooms, a *smoke alarm* is installed
    - i) in each sleeping room, and
    - ii) in a location between the sleeping rooms and the remainder of the *storey*, and if the sleeping rooms are served by a hallway, the *smoke alarm* shall be located in the hallway.

(See Note A-9.10.19.3.(1).)

2) A *smoke alarm* required by Sentence (1) shall be installed in conformance with CAN/ULC-S553, "Standard for the Installation of Smoke Alarms."

3) *Smoke alarms* required in Article 9.10.19.1. and Sentence (1) shall be installed on or near the ceiling.

#### **9.10.19.4. Power Supply**

1) Except as provided in Sentences (2) and (3), *smoke alarms* described in Sentence 9.10.19.1.(1) shall

- a) be installed with permanent connections to an electrical circuit (see Note A-3.2.4.20.(9)(a)),
- b) have no disconnect switch between the overcurrent device and the *smoke alarm*, and
- c) in case the regular power supply to the *smoke alarm* is interrupted, be provided with a battery as an alternative power source that can continue to provide power to the *smoke alarm* for a period of no less than 7 days in the normal condition, followed by 4 minutes of alarm.

2) Where the *building* is not supplied with electrical power, *smoke alarms* are permitted to be battery-operated.

3) *Suites of residential occupancy* are permitted to be equipped with *smoke detectors* in lieu of *smoke alarms*, provided the *smoke detectors*

- a) are capable of independently sounding audible signals with a sound pressure level between 75 dBA and 110 dBA within the individual *suites* (see also Note A-3.2.4.18.(4)),
- b) except as permitted in Sentence (4), are installed in conformance with CAN/ULC-S524, "Standard for Installation of Fire Alarm Systems," and
- c) form part of the fire alarm system.

(See Note A-3.2.4.20.(10).)

4) *Smoke detectors* permitted to be installed in lieu of *smoke alarms* as stated in Sentence (3) are permitted to sound localized alarms within individual *suites*, and need not sound an alarm throughout the rest of the *building*.

#### **9.10.19.5. Interconnection of Smoke Alarms**

1) Where more than one *smoke alarm* is required in a *dwelling unit*, the *smoke alarms* shall be interconnected so that the actuation of any one alarm causes all alarms within the *dwelling unit* to sound.

2) Except as provided in Sentence (3), in a principal *dwelling unit*

a) all *smoke alarms* shall be of photo-electric type and interconnected so that the actuation of any one *smoke alarm* causes all *smoke alarms* within the principal *dwelling unit* and subordinate *ancillary residential unit* including their common spaces to sound when the *fire separations* described in Articles 9.9.4.2., 9.10.9.16. and 9.10.9.17. have a *fire-resistance rating* not less than 15 min (see also Sentence 9.10.3.1.(2)), or

b) an additional *smoke alarm* of photo-electric type shall be installed in each *dwelling unit* and common space and be interconnected so that the actuation of one *smoke alarm* will cause the additional *smoke alarms* in the other *dwelling unit*, *dwelling units* or common spaces to sound when the *fire separations* described in Articles 9.9.4.2., 9.10.9.16. and 9.10.9.17. have a *fire-resistance rating* not less than 30 min (see also Sentence 9.10.3.1.(3)).

3) Deleted.

#### **9.10.19.6. Silencing of Smoke Alarms**

1) Except as permitted in Sentence (2), a manually operated device shall be incorporated within the circuitry of a *smoke alarm* installed in a *dwelling unit* so that the signal emitted by the *smoke alarm* can be silenced for a period of not more than 10 min, after which the *smoke alarm* will reset and sound again if the level of smoke in the vicinity is sufficient to re-actuate it.

2) *Suites of residential occupancy* equipped with *smoke detectors* installed to CAN/ULC-S524, "Standard for Installation of Fire Alarm Systems," which are part of the fire alarm system in lieu of *smoke alarms* as permitted in Sentence 9.10.19.4.(3), need not incorporate the manually operated device required in Sentence (1).

#### **9.10.19.7. Instructions for Maintenance and Care**

1) Where instructions are necessary to describe the maintenance and care required for *smoke alarms* to ensure continuing satisfactory performance, they shall be posted in a location where they will be readily available to the occupants for reference.

#### **9.10.19.8. Residential Fire Warning Systems**

1) Except where a fire alarm system is installed or required in a *building*, *smoke detectors* forming part of a residential fire warning system installed in conformance with CAN/ULC-S540, "Standard for Residential Fire and Life Safety Warning Systems: Installation, Inspection, Testing and Maintenance," are permitted to be installed in lieu of all *smoke alarms* required by Articles 9.10.19.1. and 9.10.19.3., provided that the fire warning system

a) is capable of sounding audible signals as stated in Articles 9.10.19.2. and 9.10.19.5.,

b) is powered as stated in Article 9.10.19.4., and

c) is equipped with a silencing device as stated in Article 9.10.19.6.

#### **9.10.20. Firefighting**

##### **9.10.20.1. Windows or Access Panels Required**

1) Except as provided in Sentence (3), a window or access panel providing an opening not less than 1 100 mm high and 550 mm wide and having a sill height of not more than 900 mm above the floor shall be provided on the second and third *storeys* of every *building* in at least one wall facing on a *street* if such *storeys* are not *sprinklered*.

2) Access panels required in Sentence (1) shall be readily openable from both inside and outside or be glazed with plain glass.

3) Access panels required in Sentence (1) need not be provided in

a) *buildings* containing only *dwelling units* where there is no *dwelling unit* above another *dwelling unit*, or

b) single detached houses.

#### **9.10.20.2. Access to Basements**

1) Except for *basements* in houses with a *secondary suite* or *basements* serving not more than one *dwelling unit*, each *basement* that is not *sprinklered* that exceeds 25 m in length or width shall be provided with direct access to the outdoors to at least one *street*.

2) Access required in Sentence (1) may be provided by a door, window or other means that provides an opening not less than 1 100 mm high and 550 mm wide, the sill height of which shall not be more than 900 mm above the floor.

3) Access required in Sentence (1) may also be provided by an interior stair accessible from the outdoors.

#### **9.10.20.3. Fire Department Access to Buildings**

1) Except as permitted by Sentence (8), access for fire department vehicles and firefighters path of travel shall be provided to each principal entrance of a *building* in accordance with Articles 3.2.5.4., 3.2.5.5. and 3.2.5.6. (See Notes A-9.10.20.3.(1) and A-3.2.5.6.(1).)

2) Where access to a *building* as required in Sentence (1) is provided by means of a roadway or yard, the design and location of such roadway or yard shall take into account connection with public thoroughfares, weight of firefighting equipment, width of roadway, radius of curves, overhead clearance, location of fire hydrants, location of fire department connections and vehicular parking.

3) Despite the provisions of Sentence (1), an unobstructed path of travel for firefighters shall be provided to an *ancillary residential building* and the path of travel shall

a) lead continuously from the *street* to the *lane*,

b) have a travel distance of no more than 45 m from the *street* to the principal entrance of the *ancillary residential building*,

c) be at least 900 mm wide,

d) have an overhead clearance of at least 2 m, and

e) consist of concrete, asphalt, or similar material.

4) An *ancillary residential building* shall have a strobe light installed and maintained outside the principal entrance, connected to an internal *smoke alarm* within the *ancillary residential building*.

5) Despite the provisions of Clause 9.10.20.3.(3)(b), the path of travel for firefighters towards not more than one *ancillary residential building* on a parcel may exceed 45 m to a maximum of 70 m provided the principal entrance to that *ancillary residential building* is visible from the *street* or provided with a strobe light connected to an internal *smoke alarm* within the *dwelling unit* that identifies the location of the principal entrance.

6) If the principal *building* and the *ancillary residential building* are adjacent to a *lane*, the path of foot travel for firefighters to the *ancillary residential building* may be through the *lane* if

a) the travel distance from the *street* to the principal entrance of the *ancillary residential building* is no more than 70 m,

b) the path has an overhead clearance of at least 3 m,

c) the path consists of concrete, asphalt, or similar material, and

d) the principal entrance of the *ancillary residential building* is visible from the *street* or provided with a strobe light connected to an internal *smoke alarm* within the *dwelling unit* that identifies the location of the principal entrance.

7) Where *acceptable* to the *Chief Building Official*, two adjacent parcels may have a single shared path of travel for firefighters over the common property line and the adjacent specified area to access both, provided

a) each parcel contains or is designed to contain an *ancillary residential building*,

b) each parcel is subject to a covenant registered on title which prohibits construction upon or obstruction of the common property line and of a specified area adjacent to the property line; and

c) the path of travel meets the requirements of Sentences (3), (4) and (5).

8) In a single detached house or duplex within the scope of Division A, Article 1.3.3.3., access routes are permitted to be located so that the path of travel for firefighters to the principal entrance of each *dwelling unit* or *ancillary floor area* is not more than

a) 45 m where

i) there are at least two paths of travel by which an occupant may reach a *street*, lane, or public thoroughfare, or

ii) the path of travel by which an occupant may reach a *street*, lane, or public thoroughfare is protected from fire exposure from *unprotected openings* in accordance with Article 9.9.4.4.,

b) 65 m where

i) there are at least two paths of travel by which an occupant may reach a *street*, lane, or public thoroughfare,

ii) the *building* is provided with *sprinklers* hydraulically designed with a 25% increase in the required discharge,

iii) the *sprinkler system* is connected to internal smoke alarms within the *dwelling unit*, provided with an exterior audible alarm, and

iv) a strobe light is installed outside the principal entrance of the *dwelling unit*, and is connected to an internal *smoke alarm* within the *dwelling unit*, or

c) 90 m where

i) the requirements of Subclauses (b)(i) to (b)(iv) have been satisfied,

ii) no principal *dwelling unit* or its *ancillary residential unit* is located above another *dwelling unit*,

iii) an access path of at least 1.2 m wide is provided from each principal *dwelling unit* entry to the *street*, and

vi) lighting is provided along the path of travel for firefighters with a minimum illumination level of 1 lx at ground level (also see Article 10. 2.2.10.) along the path.

#### **9.10.20.4. Portable Extinguishers**

1) Portable extinguishers shall be installed in all *buildings*, except within *dwelling units*, in conformance with the appropriate provincial or territorial regulations or municipal bylaws or, in the absence of such regulations or bylaws, the NFC.

#### **9.10.20.5. Freeze Protection of Fire Protection Systems**

1) Equipment forming part of a fire protection system that may be adversely affected by freezing temperatures and that is located in an unheated area shall be protected from freezing.

#### **9.10.21. Fire Protection for Construction Camps**

#### **9.10.21.1. Requirements for Construction Camps**

1) Except as provided in Articles 9.10.21.2. to 9.10.21.9., construction camps shall conform to Subsections 9.10.1. to 9.10.20.

#### **9.10.21.2. Separation of Sleeping Rooms**

1) Except for sleeping rooms within *dwelling units*, sleeping rooms in construction camps shall be separated from each other and from the remainder of the *building* by a *fire separation* having not less than a 30 min *fire-resistance rating*.

#### **9.10.21.3. Floor Assemblies between the First and Second Storey**

1) Except in a *dwelling unit*, a floor assembly in a construction camp *building* separating the *first storey* and the *second storey* shall be constructed as a *fire separation* having not less than a 30 min *fire-resistance rating*.

#### **9.10.21.4. Walkways Connecting Buildings**

1) *Walkways* of *combustible construction* connecting *buildings* shall be separated from each connected *building* by a *fire separation* having not less than a 45 min *fire-resistance rating*.

#### **9.10.21.5. Spatial Separations**

1) Construction camp *buildings* shall be separated from each other by a distance of not less than 10 m except as otherwise permitted in Subsections 9.10.14. and 9.10.15.

#### **9.10.21.6. Flame-Spread Ratings**

1) Except in *dwelling units* and except as provided in Sentence (2), the surface *flame-spread rating* of wall and ceiling surfaces in corridors and *walkways*, exclusive of doors, shall not exceed 25 over not less than 90% of the exposed surface area and not more than 150 over the remaining surface area.

2) Except within *dwelling units*, corridors that provide *access to exit* from sleeping rooms and that have a *fire-resistance rating* of not less than 45 min shall have a *flame-spread rating* conforming to the appropriate requirements in Subsection 9.10.17.

#### **9.10.21.7. Smoke Detectors**

1) Except in *dwelling units*, corridors providing *access to exit* from sleeping rooms in construction camp *buildings* with sleeping accommodation for more than 10 persons shall be provided with a *smoke detector* connected to the *building* alarm system.

#### **9.10.21.8. Portable Fire Extinguishers**

1) Each construction camp *building* shall be provided with portable fire extinguishers in conformance with the appropriate provincial or territorial regulations or municipal bylaws or, in the absence of such regulations or bylaws, in conformance with the NFC.

#### **9.10.21.9. Hose Stations**

1) Every construction camp *building* providing sleeping accommodation for more than 30 persons shall be provided with a hose station that is protected from freezing and is equipped with a hose of sufficient length so that every portion of the *building* is within reach of a hose stream.

2) Hose stations required in Sentence (1) shall be located near an *exit*.

3) Hoses referred to in Sentence (1) shall be not less than 19 mm inside diam and shall be connected to a central water supply or to a storage tank having a capacity of not less than 4 500 L

with a pumping system capable of supplying a flow of not less than 5 L/s at a gauge pressure of 300 kPa.

## **9.10.22. Fire Protection for Gas, Propane and Electric Cooktops and Ovens**

(See Note A-9.10.22.)

### **9.10.22.1. Installation of Cooktops and Ovens**

1) Except as required in Sentence (2), natural gas and propane *cooktops* and ovens shall be installed in accordance with the applicable provincial or territorial regulations or municipal bylaws or, in the absence of such regulations or bylaws, with CSA B149.1, "Natural gas and propane installation code." (See also Article 9.34.1.1.)

2) Clearances for and protection around gas, propane and electric ranges shall be not less than those provided in Articles 9.10.22.2. and 9.10.22.3.

### **9.10.22.2. Vertical Clearances above Cooktops**

1) Except as provided in Sentence (2), framing, finishes and cabinetry installed directly above the location of the *cooktop* shall be not less than 750 mm above the level of *cooktop* burners or elements.

2) The vertical clearance described in Sentence (1) for framing, finishes and cabinets located directly above the location of the *cooktop* may be reduced to 600 mm above the level of the elements or burners, provided the framing, finishes and cabinets

- a) are *noncombustible*, or
- b) are protected by
  - i) non-combustible cementitious board not less than 6 mm thick, covered with sheet metal not less than 0.33 mm thick, or
  - ii) a metal hood that projects 125 mm beyond the framing, finishes and cabinets.

### **9.10.22.3. Protection around Cooktops**

1) Except as provided in Sentences (2) and (3), *combustible* wall framing, finishes or cabinets within 450 mm of the area where the *cooktop* is to be located shall be protected above the level of the heating elements or burners by

- a) gypsum board not less than 9.5 mm thick, or
- b) any material providing a *fire-resistance rating* of not less than 10 min and a *flame-spread rating* of not more than 25.

2) Counter-top splash boards or back plates that extend above the level of heating elements or burners need not be protected as described in Sentence (1).

3) Except for cabinetry described in Article 9.10.22.2., cabinetry located not less than 450 mm above the level of the heating elements or burners need not be protected as described in Sentence (1).

## **Section 9.11. Sound Transmission**

(See Note A-9.11.)

### **9.11.1. Protection from Airborne Noise**

#### **9.11.1.1. Required Protection**

1) Except as provided in Sentences (2) and (3), a *dwelling unit* shall be separated from every other space in a *building* in which noise may be generated by

a) a separating assembly and adjoining constructions, which together provide an *apparent sound transmission class (ASTC)* rating of not less than 47, or

b) a separating assembly providing a *sound transmission class (STC)* rating of not less than 50 and adjoining constructions that conform to Article 9.11.1.4.

(See Note A-9.11.1.4.)

2) In a single detached house each *dwelling unit* shall be separated from every other space in the house in which noise may be transmitted by

a) construction having

i) joist spaces are filled with sound-absorbing material of not less than 150 mm nominal thickness,

ii) stud spaces are filled with sound-absorbing material,

iii) resilient channel on one side of the separation spaced 400 or 600 mm o.c., and

iv) not less than 12.7 mm thick gypsum board on ceilings and on both sides of walls,

b) construction providing an *STC* rating of not less than 43, or

c) a separating assembly and adjoining constructions, which together provide an *ASTC* rating of not less than 40.

(See also Sentence 9.10.3.1.(2) and Note A-9.11.1.1.(2).)

3) Construction separating a *dwelling unit* from an elevator shaft or refuse chute shall have an *STC* rating of not less than 55.

4) A dwelling unit in a building containing not more than 1 or 2 primary dwelling units, need not be separated from an adjoining storage garage containing not more than five stalls, provided that the adjoining separating assemblies are provided with exterior sheathing and at least 89 mm of insulation.

#### **9.11.1.2. Determination of Sound Transmission Ratings**

1) The *STC* ratings shall be determined in accordance with ASTM E413, "Classification for Rating Sound Insulation," using the results from measurements carried out in accordance with ASTM E90, "Standard Test Method for Laboratory Measurement of Airborne Sound Transmission Loss of Building Partitions and Elements."

2) The *ASTC* ratings shall be

a) determined in accordance with ASTM E413, "Classification for Rating Sound Insulation," using the results from measurements carried out in accordance with ASTM E336, "Standard Test Method for Measurement of Airborne Sound Attenuation between Rooms in Buildings," or

b) calculated in accordance with Article 5.8.1.4. or 5.8.1.5.

#### **9.11.1.3. Compliance with Required Ratings**

1) Compliance with the required *STC* ratings shall be demonstrated through

a) measurements carried out in accordance with Sentence 9.11.1.2.(1), or

b) the construction of separating assemblies conforming to Table 9.10.3.1.-A or 9.10.3.1.-B, as applicable.



- 2) Compliance with the required *ASTC* ratings shall be demonstrated through
- a) measurements or calculations carried out in accordance with Sentence 9.11.1.2.(2), or
  - b) the construction of separating assemblies conforming to Table 9.10.3.1.-A or 9.10.3.1.-B, as applicable, that have an *STC* rating of not less than 50 in conjunction with flanking assemblies constructed in accordance with Article 9.11.1.4. (see Note A-9.11.1.3.(2)(b)).

**9.11.1.4. Adjoining Constructions**

(See Note A-9.11.1.4.)

- 1) This Article applies where the required protection is provided in accordance with Clause 9.11.1.1.(1)(b) and compliance is demonstrated in accordance with Clause 9.11.1.3.(2)(b).
- 2) Flanking wall assemblies connected to a separating floor or ceiling assembly shall be constructed with
  - a) concrete or concrete block having a mass per area greater than 200 kg/m<sup>2</sup>, or
  - b) gypsum board finish that
    - i) is supported on wood or steel framing, and
    - ii) ends or is interrupted where it meets the structure of the separating floor or ceiling assembly.
- 3) Flanking wall and ceiling assemblies connected to a separating wall assembly shall be constructed with
  - a) concrete or concrete block having a mass per area greater than 300 kg/m<sup>2</sup>, or
  - b) gypsum board finish that
    - i) is supported on wood or steel framing, and
    - ii) ends or is interrupted where it meets the structure of the separating wall assembly or, for double-stud walls, where it meets the space between the two lines of studs.
- 4) Flanking floor assemblies connected to a separating wall assembly shall be
  - a) constructed
    - i) with concrete having a mass per area greater than 300 kg/m<sup>2</sup>, or
    - ii) in accordance with Section 9.16., or
  - b) supported on joists or trusses that are not continuous across the junction and are covered with floor treatments in accordance with Table 9.11.1.4. for the applicable wall construction.

**Table 9.11.1.4.**

**Floor Treatments for Flanking Wood-Framed Floor Assemblies in Horizontally Adjoining Spaces**

**Forming Part of Sentence 9.11.1.4.(4)**

Type of Separating Wall Assembly with <i>STC</i> ≥ 50 from Table 9.10.3.1.-A	Minimum Requirements for Floor Treatments Applied Over Subfloor of Wood-Framed Flanking Floor Assemblies on Both Sides of Floor/Wall Junction
W5, W6, W10, W12 (staggered studs)	<ul style="list-style-type: none"> <li>• wood strip flooring not less than 16 mm thick aligned parallel to separating wall, or</li> <li>• one layer of OSB or plywood not less than 15.5 mm thick plus finished flooring, or</li> <li>• one additional material layer plus finished flooring having a combined mass per area not less than 8 kg/m<sup>2(1)</sup></li> </ul>

W4, W11 (staggered studs)	<ul style="list-style-type: none"> <li>• one layer of OSB or plywood not less than 12.5 mm thick plus hardwood strip flooring not less than 19 mm thick aligned parallel to separating wall, or</li> <li>• one additional material layer plus finished flooring having a combined mass per area not less than 16 kg/m<sup>2(1)</sup></li> </ul>
W8, W9 (staggered studs)	<ul style="list-style-type: none"> <li>• concrete or gypsum concrete topping not less than 19 mm thick bonded to the subfloor plus finished flooring, or</li> <li>• one additional material layer plus finished flooring having a combined mass per area not less than 32 kg/m<sup>2(1)</sup></li> </ul>
W13, W14, W15 (double stud walls)	<ul style="list-style-type: none"> <li>• where a continuous subfloor or other rigid materials at the floor/wall junction provide structural connection between the two rows of studs in the separating wall:</li> <li>• hardwood strip flooring not less than 16 mm thick aligned parallel to separating wall, or</li> <li>• one layer OSB or plywood not less than 15.5 mm thick plus finished flooring, or</li> <li>• one additional material layer plus finished flooring having a combined mass per area not less than 8 kg/m<sup>2(1)</sup></li> <li>• any finished flooring where the subfloor and other rigid materials are not connected at the floor/wall junction and where there are no structural connections between the two rows of studs in the separating wall</li> </ul>
B1 to B10	<ul style="list-style-type: none"> <li>• any finished flooring</li> </ul>

Notes to Table 9.11.1.4.:

<sup>(1)</sup> See Note A-Table 9.11.1.4.

## Section 9.12. Excavation

### 9.12.1. General

#### 9.12.1.1. Removal of Topsoil and Organic Matter

- 1) The topsoil and vegetable matter in all unexcavated areas under a *building* shall be removed.
- 2) In localities where termite infestation is known to be a problem, all stumps, roots and other wood debris shall be removed from the *soil* to a depth of not less than 300 mm in unexcavated areas under a *building*.
- 3) The bottom of every *excavation* shall be free of all organic material.

#### 9.12.1.2. Standing Water

- 1) *Excavations* shall be kept free of standing water.

#### 9.12.1.3. Protection from Freezing

- 1) The bottom of *excavations* shall be kept from freezing throughout the entire construction period.

### 9.12.2. Depth

#### 9.12.2.1. Excavation to Undisturbed Soil

- 1) *Excavations* for *foundations* shall extend to undisturbed *soil*.

#### 9.12.2.2. Minimum Depth of Foundations

- 1) Except as provided in Sentences (4) to (7), the minimum depth of *foundations* below finished ground level shall conform to Table 9.12.2.2.

Table 9.12.2.2.

**Minimum Depths of Foundations**  
**Forming Part of Sentence 9.12.2.2.(1)**

Type of Soil	Minimum Depth of <i>Foundation</i> Containing Heated <i>Basement</i> or <i>Crawl Space</i> <sup>(1)</sup>		Minimum Depth of <i>Foundation</i> Containing No Heated Space <sup>(2)</sup>	
	Good <i>Soil Drainage</i>	Poor <i>Soil Drainage</i>	Good <i>Soil Drainage</i>	Poor <i>Soil Drainage</i>
Rock	No limit	No limit	No limit	No limit
Coarse grained soils	No limit	No limit	No limit	Below the depth of frost penetration
Silt	No limit	No limit	Below the depth of frost penetration <sup>(3)</sup>	Below the depth of frost penetration
Clay or soils not clearly defined <sup>(4)</sup>	1.2 m <sup>(3)</sup>	1.2 m	1.2 m but not less than the depth of frost penetration <sup>(3)</sup>	1.2 m but not less than the depth of frost penetration

**Notes to Table 9.12.2.2.:**

<sup>(1)</sup> *Foundation* not insulated to reduce heat loss through the footings.

<sup>(2)</sup> Including *foundations* insulated to reduce heat loss through the footings.

<sup>(3)</sup> Good *soil drainage* to not less than the depth of frost penetration.

<sup>(4)</sup> See Note A-Table 9.12.2.2.

2) Where a *foundation* is insulated in a manner that will reduce heat flow to the *soil* beneath the footings, the *foundation* depth shall conform to that required for *foundations* containing no heated space. (See Note A-9.12.2.2.(2).)

3) The minimum depth of *foundations* for exterior concrete steps with more than 2 risers shall conform to Sentences (1), (2) and (5).

4) Concrete steps with 1 and 2 risers are permitted to be laid on ground level.

5) The *foundation* depths required in Sentence (1) are permitted to be decreased where experience with local *soil* conditions shows that lesser depths are satisfactory, or where the *foundation* is designed for lesser depths.

6) The *foundation* depths required by Sentence (1) do not apply to *foundations* for

a) *buildings*

i) that are not of masonry or masonry veneer construction, and

ii) whose superstructure conforms to the requirements of the deformation resistance test in CSA Z240.2.1, "Structural requirements for manufactured homes," or

b) accessory *buildings*

i) that are not of masonry or masonry veneer construction,

ii) not more than 1 *storey* in height,

iii) not more than 55 m<sup>2</sup> in *building area*, and

iv) where the distance from finished ground to the underside of the floor joists is not more than 600 mm.

7) The *foundation* depths required by Sentence (1) do not apply to *foundations* for decks and other accessible exterior platforms

a) of not more than 1 *storey*,

b) not more than 55 m<sup>2</sup> in area,

c) where the distance from finished ground to the underside of the joists is not more than 600 mm,

d) not supporting a roof, and

e) not attached to another structure, unless it can be demonstrated that differential movement will not adversely affect the performance of that structure.

8) Where decks or other accessible exterior platforms are supported on surface *foundations* supported on other than coarse-grained *soil* with good drainage or *rock*, access to the *foundation* positions to permit re-levelling of the platform shall be provided

a) by passageways with a clear height under the platform of not less than 600 mm and a width of not less than 600 mm, or

b) by installing the decking in a manner that allows easy removal.

### **9.12.3. Backfill**

#### **9.12.3.1. Placement of Backfill**

1) Backfill shall be placed to avoid damaging the *foundation* wall, the drainage tile, externally applied thermal insulation and waterproofing or dampproofing of the wall.

#### **9.12.3.2. Grading of Backfill**

1) Backfill shall be graded to prevent drainage towards the *foundation* after settling.

#### **9.12.3.3. Deleterious Debris and Boulders**

1) Backfill that is within 600 mm of the *foundation* shall be free of deleterious debris and boulders larger than 250 mm diam. (See Note A-9.12.3.3.(1).)

2) Except as provided in Sentence (3), backfill shall not contain pyritic material or material that is susceptible to ice lensing in concentrations that will damage the *building* to a degree that would adversely affect its stability or the performance of assemblies. (See Note A-9.4.4.4.(1).)

3) Backfill with material of any concentration that is susceptible to ice lensing is permitted where *foundation* walls are

a) cast-in-place concrete,

b) concrete block insulated on the exterior, or

c) concrete block protected from the backfill by a material that serves as a slip plane.

(See Note A-9.4.4.4.(1).)

### **9.12.4. Trenches beneath Footings**

#### **9.12.4.1. Support of Footings**

1) The *soil* in trenches beneath footings for sewers and watermains shall be compacted by tamping up to the level of the footing base, or shall be filled with concrete having a strength not less than 10 MPa to support the footing.

## **Section 9.13. Dampproofing, Waterproofing and Soil Gas Control**

### **9.13.1. General**

#### **9.13.1.1. Scope and Application**

- 1) This Section presents measures to control the ingress of water, moisture and *soil* gas.
- 2) Subsection 9.13.2. applies to below-ground walls and floors-on-ground where drainage is provided in accordance with Section 9.14. over and along the entire below-ground portion of the *foundation* wall.
- 3) Subsection 9.13.3. applies to below-ground walls, floors-on-ground and roofs of underground structures that are subject to hydrostatic pressure.
- 4) Subsection 9.13.4. applies to walls, roofs and floors that are in contact with the ground.

## **9.13.2. Dampproofing**

### **9.13.2.1. Required Dampproofing**

- 1) Except as provided in Article 9.13.3.1., where the exterior finished ground level is at a higher elevation than the ground level inside the *foundation* walls, exterior surfaces of *foundation* walls below ground level shall be dampproofed.
- 2) Except as provided in Sentence (3) and Article 9.13.3.1., floors-on-ground shall be dampproofed.
- 3) Dampproofing required in Sentence (2) need not be provided for
  - a) floors in garages,
  - b) floors in unenclosed portions of *buildings*, or
  - c) floors installed over not less than 100 mm of coarse clean granular material containing not more than 10% of material that will pass a 4 mm sieve.

### **9.13.2.2. Dampproofing Materials**

- 1) Materials installed to provide required dampproofing shall be
  - a) capable of protecting assemblies against moisture transfer from the ground,
  - b) compatible with adjoining materials, and
  - c) resistant to mechanisms of deterioration that may reasonably be expected, given the nature, function and exposure of the materials.
- 2) Except as otherwise specified in this Section, materials used for exterior dampproofing shall
  - a) conform to one of the following standards:
    - i) ASTM D1227/D1227M, "Standard Specification for Emulsified Asphalt Used as a Protective Coating for Roofing," Type III, Class I,
    - ii) ASTM D4479/D4479M, "Standard Specification for Asphalt Roof Coatings - Asbestos-Free," Type III,
    - iii) CAN/CGSB-51.34-M, "Vapour Barrier, Polyethylene Sheet for Use in Building Construction," or
    - iv) CAN/CSA-A123.4, "Asphalt for Constructing Built-Up Roof Coverings and Waterproofing Systems," or
  - b) have a water vapour permeance of not more than  $43 \text{ ng}/(\text{Pa}\times\text{s}\times\text{m}^2)$  when tested in accordance with Procedure A (wet cup) of ASTM E96/E96M, "Standard Test Methods for Water Vapor Transmission of Materials," and consist of one of the following material types:
    - i) a vapour-resistant coating,

- ii) a cold-fluid-applied or hot-rubberized bituminous dampproofing membrane,
- iii) a liquid-applied or spray-applied asphalt-based emulsion dampproofing, or
- iv) a type III hot-applied asphalt.

#### **9.13.2.3. Preparation of Surface**

- 1) The area in which dampproofing is to be carried out shall be kept free of water during the application and curing of the dampproofing system.
- 2) The surface to be dampproofed shall be prepared in accordance with the instructions of the dampproofing material manufacturer.
- 3) Where the dampproofing material is to be applied on insulating concrete form (ICF) walls, the instructions of the ICF wall manufacturer shall be followed.
- 4) Unit masonry walls to be dampproofed shall be parged on the exterior face below ground level with not less than 6 mm of mortar conforming to Section 9.20. covered over the footing.
- 5) Concrete walls to be dampproofed shall have holes and recesses sealed with cement mortar or a mastic or sealant that is suitable for vertical applications and compatible with the dampproofing material.
- 6) The surface required to be dampproofed shall be clean and dry and free of ice, snow, frost, dust, dirt, oil, grease, cracks, projections and depressions, loose particles and debris that could be detrimental to the performance of the material to be applied.

#### **9.13.2.4. Application of Dampproofing Material**

- 1) Exterior dampproofing shall be applied from finished ground level to the top of the exterior of the footing.
- 2) Unless otherwise stated in this Subsection, dampproofing shall be installed in accordance with the manufacturer's instructions with regard to
  - a) surface priming,
  - b) conditions during application,
  - c) application quantity and rate, and
  - d) curing times.
- 3) Joints, cracks and penetrations shall be sealed to maintain the continuity of the dampproofing, where the dampproofing material is not capable of bridging such discontinuities.

#### **9.13.2.5. Moisture Protection for Interior Finishes**

(See Note A-9.13.2.5.)

- 1) The interior surface of *foundation* walls below ground level shall be protected by means that minimize the ingress of moisture from the *foundation* wall into interior spaces, where
  - a) a separate interior finish is applied to a concrete or unit masonry wall that is in contact with the *soil*, or
  - b) wood members are placed in contact with such walls for the installation of insulation or finish.
- 2) Except as provided in Sentence (3), where the protection of interior finishes required in Sentence (1) consists of membranes or coatings,

a) the membrane or coating shall extend from the *basement* floor surface up to the highest extent of the interior insulation or finish, but not higher than the exterior finished ground level, and

b) no membrane or coating with a permeance less than  $170 \text{ ng}/(\text{Pa}\times\text{s}\times\text{m}^2)$  shall be applied to the interior surface of the *foundation* wall above ground level between the insulation and the *foundation* wall.

3) Where insulation functions as both moisture protection for interior finishes and as a *vapour barrier* in accordance with Subsection 9.25.4., it shall be applied over the entire interior surface of the *foundation* wall.

#### **9.13.2.6. Dampproofing of Floors-on-Ground**

1) Where dampproofing is installed below the floor, it shall consist of

- a) polyethylene not less than 0.15 mm thick with joints lapped not less than 100 mm,
- b) type S roll roofing with joints lapped not less than 100 mm, or
- c) rigid extruded/expanded polystyrene with sealed or ship-lapped joints that has
  - i) sufficient compressive strength to support the floor assembly, and
  - ii) a water vapour permeance complying with Clause 9.13.2.2.(2)(a).

2) Where dampproofing is installed between a floor-on-ground and a finished floor, it shall consist of

- a) rigid extruded/expanded polystyrene with sealed or ship-lapped joints that has
  - i) sufficient compressive strength to support the floor assembly, and
  - ii) a water vapour permeance complying with Clause 9.13.2.2.(2)(b), or
- b) polyethylene not less than 0.05 mm thick with joints lapped not less than 100 mm.

#### **9.13.3. Waterproofing**

##### **9.13.3.1. Required Waterproofing**

1) Where hydrostatic pressure occurs, waterproofing is required for assemblies separating interior space from the ground to prevent the ingress of water into *building* assemblies and interior spaces.

2) Waterproofing is required for roofs of underground structures to prevent the ingress of water into *building* assemblies and interior spaces.

##### **9.13.3.2. Waterproofing Materials**

1) Materials installed to provide required waterproofing shall be

- a) compatible with adjoining materials, and
- b) resistant to mechanisms of deterioration that may reasonably be expected, given the nature, function and exposure of the materials, and
- c) free of asbestos or components that contain asbestos.

2) Materials used for exterior waterproofing shall conform to

a) ASTM D1227/D1227M, "Standard Specification for Emulsified Asphalt Used as a Protective Coating for Roofing," in which case, they shall be installed in accordance with Sentence 9.13.3.3.(3),

- b) ASTM D3019/D3019M, "Standard Specification for Lap Cement Used with Asphalt Roll Roofing, Non-Fibered, and Fibered," where non-fibered and non-asbestos-fibered (Types I and III) asphalt roll roofing are permitted,
- c) ASTM D4479/D4479M, "Standard Specification for Asphalt Roof Coatings – Asbestos-Free," in which case, they shall be installed in accordance with Sentence 9.13.3.3.(3) and with reinforcing material,
- d) ASTM D4637/D4637M, "Standard Specification for EPDM Sheet Used In Single-Ply Roof Membrane,"
- e) ASTM D4811/D4811M, "Standard Specification for Nonvulcanized (Uncured) Rubber Sheet Used as Roof Flashing,"
- f) ASTM D6878/D6878M, "Standard Specification for Thermoplastic Polyolefin Based Sheet Roofing,"
- g) CGSB 37-GP-9Ma, "Primer, Asphalt, Unfilled, for Asphalt Roofing, Dampproofing and Waterproofing," where a primer is required,
- h) CAN/CGSB-37.50-M, "Hot-Applied, Rubberized Asphalt for Roofing and Waterproofing,"
- i) CAN/CGSB-37.54, "Polyvinyl Chloride Roofing and Waterproofing Membrane,"
- j) CGSB 37-GP-56M, "Membrane, Modified, Bituminous, Prefabricated, and Reinforced for Roofing,"
- k) CAN/CGSB-37.58-M, "Membrane, Elastomeric, Cold-Applied Liquid, for Non-Exposed Use in Roofing and Waterproofing,"
- l) CAN/CSA-A123.2, "Asphalt-Coated Roofing Sheets,"
- m) CAN/CSA-A123.4, "Asphalt for Constructing Built-Up Roof Coverings and Waterproofing Systems," in which case, they shall be installed with reinforcing material, or
- n) CSA A123.17, "Asphalt Glass Felt Used in Roofing and Waterproofing."

#### **9.13.3.3. Preparation of Surface**

- 1) Surfaces to be waterproofed shall be prepared in accordance with the instructions of the waterproofing material manufacturer.
- 2) Where the waterproofing material is to be applied on ICF walls, the instructions of the ICF wall manufacturer shall be followed.
- 3) Unit masonry walls that are to be waterproofed shall be parged on exterior surfaces below ground level with not less than 6 mm of mortar conforming to Section 9.20. covered over the footing.
- 4) Concrete walls that are to be waterproofed shall have all holes and recesses sealed with mortar or waterproofing material.
- 5) Surfaces required to be waterproofed shall be clean and dry and free of ice, snow, frost, dust, dirt, oil, grease, cracks, projections and depressions, loose particles and debris that could be detrimental to the performance of the waterproofing material.

#### **9.13.3.4. Application of Waterproofing Membranes**

- 1) Unless otherwise stated in this Subsection, waterproofing shall be installed in accordance with the manufacturer's instructions with regard to



- a) surface priming,
  - b) conditions during application,
  - c) the required number of layers of reinforcing fabric on *foundation*, footings, floors, walls and structural slabs,
  - d) application quantity and rate, and
  - e) curing times.
- 2) Waterproofing shall be continuous across joints and at junctions between different *building* elements.
- 3) The waterproofed surface shall be protected with a suitable material to minimize mechanical damage during backfilling.
- 4) The area in which the waterproofing is to be carried out shall be kept free of water during the application and curing of the waterproofing system.

#### **9.13.3.5. Floor Waterproofing System**

1) *Basement* floors-on-ground to be waterproofed shall have a system of membrane waterproofing provided between 2 layers of concrete, each of which shall be not less than 75 mm thick, with the floor membrane made continuous with the wall membrane to form a complete seal.

#### **9.13.4. Soil Gas Control**

(See Note A-9.13.4.)

##### **9.13.4.1. Application and Scope**

- 1) This Subsection applies to
- a) a *conditioned space* that has a wall, roof or floor assembly, or part thereof, that is in contact with the ground, and
  - b) the protection of the *conditioned space* described in Clause (a).
- 2) This Subsection addresses the leakage of *soil gas* from the ground into the *building*.

##### **9.13.4.2. Protection from Soil Gas Ingress**

- 1) All wall, roof and floor assemblies, or parts thereof, separating *conditioned space* from the ground shall be protected by an *air barrier system* conforming to Subsection 9.25.3.
- 2) Unless the space between the *air barrier system* and the ground is designed to be accessible for the future installation of a subfloor depressurization system, *buildings* shall
- a) be provided with the rough-in for a subfloor depressurization system conforming to Article 9.13.4.3., or
  - b) conform to Parts 5 and 6 for the protection from radon ingress and the means to address high radon concentrations in the future (see Articles 5.4.1.1. and 6.2.1.1.).

##### **9.13.4.3. Rough-in for a Subfloor Depressurization System**

(See Note A-9.13.4.3.)

1) Floors-on-ground shall accommodate the future installation of a subfloor depressurization system by installing a radon vent pipe, and a contiguous gas-permeable layer between the *air barrier system* and the ground consisting of

- a) a material or materials that allow effective depressurization of that space (see Sentence 9.16.2.1.(1)), or
  - b) not less than 100 mm of coarse clean granular material containing not more than 10% of material that would pass a 4 mm sieve.
- 2) The radon vent pipe required by Sentence (1) shall
- a) be sealed to maintain the integrity of the *air barrier system*, with no perforations along the pipe above the *air barrier system*,
  - b) have one or more inlets that allow for the effective depressurization of the gas-permeable layer (see Note A-9.13.4.3.(2)(b) and (3)(b)), and
  - c) permit connection to depressurization equipment,
  - d) where it passes through *conditioned space*, be completely surrounded by *conditioned space*,
  - e) consist of pipe and fittings in accordance with 7.1.3 of CAN/CGSB-149.11, "Radon control options for new construction in low-rise residential buildings,"
  - f) terminate outside the *building* in a manner that does not constitute a hazard,
  - g) be installed to prevent the accumulation of moisture and away from locations where snow and ice accumulate, and
  - h) be clearly labeled every 1.8 m and at every change in direction to indicate that it is intended only for the future removal of radon from below the floor-on-ground.
- 3) A radon vent pipe shall be deemed to comply with
- a) Clause (2)(b) where its inlet or inlets below the *air barrier system* are located at or near the centre of the floor-on-ground with gas-permeable material extending not less than 100 mm beyond any inlet, and
  - b) Clause (2)(f) where it terminates outside the *building*, not less than 1.8 m from a property line, and located in accordance with either 7.2.4.6 or 7.3.4 of CAN/CGSB-149.11, "Radon control options for new construction in low-rise residential buildings," with the opening of the pipe fitted with a corrosion-resistant screen or grille with a mesh opening size of 10 mm to 12.5 mm or a product of equivalent air flow performance.

## **Section 9.14. Drainage**

### **9.14.1. Scope**

#### **9.14.1.1. Application**

- 1) This Section applies to subsurface drainage and to surface drainage.

#### **9.14.1.2. Crawl Spaces**

- 1) Drainage for crawl spaces shall conform to Section 9.18.

#### **9.14.1.3. Floors-on-Ground**

- 1) Drainage requirements beneath floors-on-ground shall conform to Section 9.16.

### **9.14.2. Foundation Drainage**

#### **9.14.2.1. Foundation Wall Drainage**

- 1) Unless it can be shown to be unnecessary, the bottom of every exterior *foundation* wall shall be drained by drainage tile or pipe laid around the exterior of the *foundation* in conformance

with Subsection 9.14.3. or by a layer of gravel or crushed *rock* in conformance with Subsection 9.14.4.

2) Where mineral fibre insulation or crushed *rock* backfill is provided adjacent to the exterior surface of a *foundation* wall,

a) the insulation or backfill shall extend to the footing level to facilitate the drainage of ground water to the *foundation's* drainage system (see Note A-9.14.2.1.(2)(a)), and

b) any pyritic material in the crushed *rock* shall be limited to a concentration that will not damage the *building* to a degree that would adversely affect its stability or the performance of assemblies (see Sentence 9.12.3.3.(2) and Note A-9.4.4.4.(1)).

### **9.14.3. Drainage Tile and Pipe**

#### **9.14.3.1. Material Standards**

1) Drain tile and drain pipe for *foundation* drainage shall conform to

a) ASTM C4, "Standard Specification for Clay Drain Tile and Perforated Clay Drain Tile,"

b) ASTM C412M, "Standard Specification for Concrete Drain Tile,"

c) ASTM C444M, "Standard Specification for Perforated Concrete Pipe,"

d) ASTM C700, "Standard Specification for Vitrified Clay Pipe, Extra Strength, Standard Strength, and Perforated,"

e) BNQ 3624-115, "Polyethylene (PE) Pipe and Fittings for Soil and Foundation Drainage,"

f) CSA B182.1, "Plastic drain and sewer pipe and pipe fittings," or

g) CAN/CSA-G401, "Corrugated steel pipe products."

#### **9.14.3.2. Minimum Size**

1) Drain tile or pipe used for *foundation* drainage shall be not less than 100 mm in diam.

#### **9.14.3.3. Installation**

1) Drain tile or pipe shall be laid on undisturbed or well-compacted *soil* so that the top of the tile or pipe is below the bottom of the floor slab or the ground cover of the crawl space.

2) Drain tile or pipe with butt joints shall be laid with 6 mm to 10 mm open joints.

3) The top half of joints referred to in Sentence (2) shall be covered with sheathing paper, 0.10 mm polyethylene or No. 15 asphalt or tar-saturated felt.

4) The top and sides of drain pipe or tile shall be covered with not less than 150 mm of crushed stone or other coarse clean granular material containing not more than 10% of material that will pass a 4 mm sieve.

### **9.14.4. Granular Drainage Layer**

#### **9.14.4.1. Type of Granular Material**

1) Granular material used to drain the bottom of a *foundation* shall consist of a continuous layer of crushed stone or other coarse clean granular material containing

a) not more than 10% of material that will pass a 4 mm sieve, and

b) no pyritic material in a concentration that will damage the *building* to a degree that would adversely affect its stability or the performance of assemblies (see Note A-9.4.4.4.(1)).

#### **9.14.4.2. Installation**

1) Granular material described in Article 9.14.4.1. shall be laid on undisturbed or compacted *soil* to a minimum depth of not less than 125 mm beneath the footing of the *building* and extend not less than 300 mm beyond the outside edge of the footings.

#### **9.14.4.3. Grading**

1) The bottom of an *excavation* drained by a granular layer shall be graded so that the entire area described in Article 9.14.4.2. is drained to a sump conforming to Article 9.14.5.2.

#### **9.14.4.4. Wet Site Conditions**

1) Where because of wet site conditions *soil* becomes mixed with the granular drainage material, sufficient additional granular material shall be provided so that the top 125 mm are kept free of *soil*.

### **9.14.5. Drainage Disposal**

#### **9.14.5.1. Drainage Disposal**

1) *Foundation* drains shall drain to a sewer, drainage ditch or dry well.

#### **9.14.5.2. Sump Pits**

1) Where a sump pit is provided it shall be

- a) not less than 750 mm deep,
- b) not less than 0.25 m<sup>2</sup> in area, and
- c) provided with a cover.

2) Covers for sump pits shall be designed

- a) to resist removal by children, and
- b) to be airtight in accordance with Sentence 9.25.3.3.(7).

3) Where gravity drainage is not practical, an automatic sump pump shall be provided to discharge the water from the sump pit described in Sentence (1) into a sewer, drainage ditch or dry well.

#### **9.14.5.3. Dry Wells**

1) Dry wells may be used only when located in areas where the natural *groundwater level* is below the bottom of the dry well.

2) Dry wells shall be not less than 5 m from the *building foundation* and located so that drainage is away from the *building* (See Note A-9.14.5.3.(2)).

### **9.14.6. Surface Drainage**

#### **9.14.6.1. Surface Drainage**

1) The *building* shall be located or the *building* site graded so that water will not accumulate at or near the *building*.

#### **9.14.6.2. Drainage away from Wells or Septic Disposal Beds**

1) Surface drainage shall be directed away from the location of a water supply well or septic tank disposal bed.

#### **9.14.6.3. Window Wells**

1) Every window well shall be drained to the footing level or other suitable location.

#### **9.14.6.4. Catch Basin**

1) Where runoff water from a driveway is likely to accumulate or enter a garage, a catch basin shall be installed to provide adequate drainage.

#### **9.14.6.5. Downspouts**

1) Downspouts shall conform to Article 9.26.18.2.

## **Section 9.15. Footings and Foundations**

### **9.15.1. Application**

#### **9.15.1.1. General**

(See Notes A-9.15.1.1. and A-9.4.4.6. and 9.15.1.1.)

1) Except as provided in Articles 9.15.1.2. and 9.15.1.3., this Section applies to

a) concrete or unit masonry *foundation* walls and concrete footings not subject to surcharge

i) on stable *soils* with an allowable bearing pressure of 75 kPa or greater, and

ii) for *buildings* of wood-frame or masonry construction,

b) wood-frame *foundation* walls and wood or concrete footings not subject to surcharge

i) on stable *soils* with an allowable bearing pressure of 75 kPa or greater, and

ii) for *buildings* of wood-frame construction, and

c) flat insulating concrete form *foundation* walls and concrete footings not subject to surcharge (see Note A-9.15.1.1.(1)(c) and 9.20.1.1.(1)(b))

i) on stable *soils* with an allowable bearing pressure of 75 kPa or greater, and

ii) for *buildings* of light-frame or flat insulating concrete form construction that are not more than 2 *storeys* in *building height*, with a maximum floor-to-floor height of 3 m.

2) *Foundations* for applications other than as described in Sentence (1) shall be designed in accordance with Section 9.4.

#### **9.15.1.2. Permafrost**

1) *Buildings* erected on permafrost shall have *foundations* designed by a *designer* competent in this field in accordance with the appropriate requirements of Part 4.

#### **9.15.1.3. Foundations for Deformation-Resistant Buildings**

1) Where the superstructure of a detached *building* conforms to the requirements of the deformation resistance test in CSA Z240.2.1, "Structural requirements for manufactured homes," the *foundation* shall be constructed in conformance with

a) the remainder of this Section, or

b) CSA Z240.10.1, "Site preparation, foundation, and installation of buildings."

### **9.15.2. General**

#### **9.15.2.1. Concrete**

1) Concrete shall conform to Section 9.3.

#### **9.15.2.2. Unit Masonry Construction**

1) Concrete block shall conform to CSA A165.1, "Concrete block masonry units," and shall have a compressive strength over the average net cross-sectional area of the block of not less than 15 MPa.

2) Mortar, grout, mortar joints, corbelling and protection for unit masonry shall conform to Section 9.20.

3) For concrete block *foundation* walls required to be reinforced,

a) mortar shall be Type S, conforming to CAN/CSA-A179, "Mortar and Grout for Unit Masonry,"

b) grout shall be coarse, conforming to CAN/CSA-A179, "Mortar and Grout for Unit Masonry," and

c) placement of grout shall conform to CAN/CSA-A371, "Masonry Construction for Buildings."

#### **9.15.2.3. Pier-Type Foundations**

1) Where pier-type *foundations* are used, the piers shall be designed to support the applied loads from the superstructure.

2) Where piers are used as a *foundation* system in a *building* of 1 storey in *building height*, the piers shall be installed to support the principal framing members and shall be spaced not more than 3.5 m apart along the framing, unless the piers and their footings are designed for larger spacings.

3) The height of piers described in Sentence (2) shall not exceed 3 times their least dimension at the base of the pier.

4) Where concrete block is used for piers described in Sentence (2), they shall be laid with cores placed vertically, and where the width of the *building* is 4.3 m or less, placed with their longest dimension at right angles to the longest dimension of the *building*.

#### **9.15.2.4. Wood-Frame Foundations**

1) *Foundations* of wood-frame construction shall conform to

a) CSA S406, "Specification of permanent wood foundations for housing and small buildings," or

b) Part 4.

(See Note A-9.15.2.4.(1).)

### **9.15.3. Footings**

#### **9.15.3.1. Footings Required**

1) Footings shall be provided under walls, pilasters, columns, piers, fireplaces and *chimneys* that bear on *soil* or *rock*, except that footings may be omitted under piers or monolithic concrete walls if the safe *loadbearing* capacity of the *soil* or *rock* is not exceeded.

#### **9.15.3.2. Support of Footings**

1) Footings shall rest on undisturbed *soil*, *rock* or compacted granular *fill*.

2) Granular *fill* shall not contain pyritic material in a concentration that will damage the *building* to a degree that would adversely affect its stability or the performance of assemblies. (See also Article 9.4.4.4. and Note A-9.4.4.4.(1).)

#### **9.15.3.3. Application of Footing Width and Area Requirements**

1) Except as provided in Sentence 9.15.3.4.(2), the minimum footing width or area requirements provided in Articles 9.15.3.4. to 9.15.3.7. shall apply to footings, where

a) the footings support

- i) *foundation* walls of masonry, concrete, or flat insulating concrete form walls,
  - ii) above-ground walls of masonry, flat insulating concrete form walls or light wood-frame construction, and
  - iii) floors and roofs of light wood-frame construction,
  - b) the span of supported joists does not exceed 4.9 m, and
  - c) the specified *live load* on any floor supported by the footing does not exceed 2.4 kPa (see Table 4.1.5.3.).
- 2) Except as provided in Sentence 9.15.3.4.(2), where the span of the supported joists exceeds 4.9 m, footings shall be designed in accordance with Section 4.2.
- 3) Where the specified *live load* exceeds 2.4 kPa, footings shall be designed in accordance with Section 4.2.

**9.15.3.4. Basic Footing Widths and Areas**

- 1) Except as provided in Sentences (2) and (3) and in Articles 9.15.3.5. to 9.15.3.7., the minimum footing width or area shall comply with Table 9.15.3.4.
- 2) Where the supported joist span exceeds 4.9 m in *buildings* with light wood-frame walls, floors and roofs, strip footing widths shall be determined according to

- a) Section 4.2., or
- b) the following formula

$$W = w \times [\Sigma s_{js} / (\text{storeys} \times 4.9)]$$

where

W = minimum footing width,

w = minimum width of footings supporting joists not exceeding 4.9 m, as defined by Table 9.15.3.4.,

$\Sigma s_{js}$  = sum of the supported joist spans on each *storey* bearing on an exterior wall whose load is transferred to the footing, or sum of half of the supported joist spans on each *storey* bearing on both sides of an interior wall whose load is transferred to the footing, and

*storeys* = number of *storeys* supported by the footing.

(See Note A-9.15.3.4.(2).)

- 3) Where a *foundation* rests on gravel, sand or silt in which the water table level is less than the width of the footings below the *bearing surface*,

- a) the footing width for walls shall be not less than twice the width required by Sentences (1) and (2), and Articles 9.15.3.5. and 9.15.3.6., and
- b) the footing area for columns shall be not less than twice the area required by Sentences (1) and (2) and Article 9.15.3.7.

**Table 9.15.3.4.**

**Minimum Footing Sizes**

**Forming Part of Sentence 9.15.3.4.(1)**

No. of Floors Supported	Minimum Width of Strip Footings, mm		Minimum Footing Area for Columns Spaced 3 m o.c., <sup>(1)</sup> m <sup>2</sup>
	Supporting Exterior Walls <sup>(2)</sup>	Supporting Interior Walls <sup>(3)</sup>	

1	250	200	0.4
2	350	350	0.75
3	450	500	1.0

**Notes to Table 9.15.3.4.:**

- <sup>(1)</sup> See Sentence 9.15.3.7.(1).  
<sup>(2)</sup> See Sentence 9.15.3.5.(1).  
<sup>(3)</sup> See Sentence 9.15.3.6.(1).

**9.15.3.5. Adjustments to Footing Widths for Exterior Walls**

- 1) The strip footing widths for exterior walls shown in Table 9.15.3.4. shall be increased by
- 65 mm for each *storey* of masonry veneer over wood-frame construction supported by the *foundation wall*,
  - 130 mm for each *storey* of masonry construction supported by the *foundation wall*, and
  - 150 mm for each *storey* of flat insulating concrete form wall construction supported by the *foundation wall*.

**9.15.3.6. Adjustments to Footing Widths for Interior Walls**

- 1) The minimum strip footing widths for interior *loadbearing* masonry walls shown in Table 9.15.3.4. shall be increased by 100 mm for each *storey* of masonry construction supported by the footing.
- 2) Footings for interior non-*loadbearing* masonry walls shall be not less than 200 mm wide for walls up to 5.5 m high and the width shall be increased by 100 mm for each additional 2.7 m of height.

**9.15.3.7. Adjustments to Footing Area for Columns**

- 1) The footing area for column spacings other than shown in Table 9.15.3.4. shall be adjusted in proportion to the distance between columns.

**9.15.3.8. Footing Thickness**

- 1) Footing thickness shall be not less than the greater of
- 100 mm, or
  - the width of the projection of the footing beyond the supported element.

**9.15.3.9. Step Footings**

- 1) Where step footings are used,
- the vertical rise between horizontal portions shall not exceed 600 mm, and
  - the horizontal distance between risers shall not be less than 600 mm.

**9.15.4. Foundation Walls**

**9.15.4.1. Flat Wall Insulating Concrete Form Units**

- 1) Flat wall insulating concrete form units shall conform to CAN/ULC-S717.1, "Standard for Flat Wall Insulating Concrete Form (ICF) Units – Material Properties."

**9.15.4.2. Foundation Wall Thickness and Required Lateral Support**

- 1) Except as required in Sentence (2), the thickness of *foundation* walls made of unreinforced concrete block, concrete core in flat wall insulating concrete forms or solid concrete and subject to



lateral earth pressure shall conform to Table 9.15.4.2.-A for walls not exceeding 3.0 m in unsupported height.

2) The concrete core in flat insulating concrete form *foundation* walls shall be not less than the greater of

- a) 150 mm, or
- b) the thickness of the concrete in the wall above.

**Table 9.15.4.2.-A**

**Thickness of Solid Concrete, Concrete Core in Flat Wall Insulating Concrete Form and Unreinforced Concrete Block Foundation Walls**

**Forming Part of Sentence 9.15.4.2.(1)**

Type of <i>Foundation Wall</i>	Minimum Thickness of Concrete or Concrete Block, mm	Maximum Height of Finished Ground Above <i>Basement Floor</i> or <i>Crawl Space Ground Cover</i> , m			
		Height of <i>Foundation Wall</i> Laterally Unsupported at the Top <sup>(1)(2)</sup>	Height of <i>Foundation Wall</i> Laterally Supported at the Top <sup>(1)(2)</sup>		
			≤ 3.0 m	≤ 2.5 m	> 2.5 m and ≤ 2.75 m
Solid concrete and concrete core in flat wall insulating concrete forms, <sup>(3)</sup> 15 MPa min. strength	150	0.8	1.5	1.5	1.4
	200	1.2	2.15	2.15	2.1
	250	1.4	2.3	2.6	2.5
	300	1.5	2.3	2.6	2.85
Solid concrete and concrete core in flat wall insulating concrete forms, <sup>(3)</sup> 20 MPa min. strength	150	0.8	1.8	1.6	1.6
	200	1.2	2.3	2.3	2.2
	250	1.4	2.3	2.6	2.85
	300	1.5	2.3	2.6	2.85
Unreinforced concrete block	140	0.6	0.8	—	—
	190	0.9	1.2	<sup>(4)</sup>	<sup>(4)</sup>
	240	1.2	1.8	<sup>(4)</sup>	<sup>(4)</sup>
	290	1.4	2.2	—	—

**Notes to Table 9.15.4.2.-A:**

- <sup>(1)</sup> See Article 9.15.4.3.
- <sup>(2)</sup> See Article 9.15.4.6.
- <sup>(3)</sup> See Note A-Table 9.15.4.2.-A.
- <sup>(4)</sup> See Table 9.15.4.2.-B.

3) The thickness and reinforcing of *foundation* walls made of reinforced concrete block and subject to lateral earth pressure shall conform to Table 9.15.4.2.-B and Sentences (4) to (7), where

- a) the walls are laterally supported at the top,
- b) average stable *soils* are encountered, and
- c) wind loads on the exposed portion of the *foundation* are no greater than 0.70 kPa.

- 4) For concrete block walls required to be reinforced, continuous vertical reinforcement shall
- be provided at wall corners, wall ends, wall intersections, at changes in wall height, at the jambs of all openings and at movement joints,
  - extend from the top of the footing to the top of the *foundation* wall, and
  - where *foundation* walls are laterally supported at the top, have not less than 50 mm embedment into the footing, if the floor slab does not provide lateral support at the wall base.
- 5) For concrete block walls required to be reinforced, a continuous horizontal bond beam containing not less than one 15M bar shall be installed
- along the top of the wall,
  - at the sill and head of all openings greater than 1.20 m in width, and
  - at structurally connected floors.

**Table 9.15.4.2.-B**

**Reinforced Concrete Block Foundation Walls Laterally Supported at the Top(1)  
Forming Part of Sentence 9.15.4.2.(3)**

Maximum Height of Finished Ground Above Basement Floor or Crawl Space Ground Cover, m <sup>(2)</sup>	Size and Spacing of Continuous Vertical Reinforcement, M at mm o.c.					
	190 mm Minimum Wall Thickness			240 mm Minimum Wall Thickness		
	Foundation Wall Height			Foundation Wall Height		
	≤ 2.5 m	≤ 2.75 m	≤ 3.0 m	≤ 2.5 m	≤ 2.75 m	≤ 3.0 m
0.8	(3)	(3)	(3)	(3)	(3)	(3)
1	(3)	1-15M at 1 800	1-15M at 1 800	(3)	(3)	(3)
1.2	(3)	1-15M at 1 600	1-15M at 1 600	(3)	1-20M at 2 000	1-20M at 2 000
1.4	1-15M at 1 600	1-15M at 1 600	1-15M at 1 600	(3)	1-20M at 1 800	1-20M at 1 800
1.6	1-15M at 1 400	1-15M at 1 400	1-15M at 1 400	(3)	1-20M at 1 600	1-20M at 1 600
1.8	1-15M at 1 400	1-15M at 1 400	1-15M at 1 200	(3)	1-20M at 1 600	1-20M at 1 600
2	1-15M at 1 200	1-15M at 1 000 or 1-20M at 1 200	2-15M at 1 200	1-20M at 1 600	1-20M at 1 600	1-20M at 1 600
2.2	2-15M at 1 200	2-15M at 1 000	2-15M at 1 000	1-20M at 1 400	1-20M at 1 400	1-20M at 1 400
2.4	2-15M at 1 000	2-15M at 1 000	2-15M at 800	1-20M at 1 400	1-20M at 1 400	1-20M at 1 200
2.6	n/a	2-15M at 800 or 1-25M at 1 000	2-15M at 800 or 1-25M at 1 000	n/a	1-20M at 1 000	1-20M at 1 000

2.8	n/a	n/a	1-20M at 600	n/a	n/a	1-20M at 800 or 2-15M at 1 000
3	n/a	n/a	1-20M at 400 or 1-25M at 600	n/a	n/a	2-15M at 800

**Notes to Table 9.15.4.2.-B:**

<sup>(1)</sup> See Article 9.15.4.3.

<sup>(2)</sup> See Article 9.15.4.6.

<sup>(3)</sup> No reinforcement required.

6) In concrete block walls required to be reinforced, all vertical bar reinforcement shall be installed along the centre line of the wall.

7) In concrete block walls required to be reinforced, ladder- or truss-type lateral reinforcement not less than 3.8 mm in diameter (no. 9 ASWG) shall be installed in the bed joint of every second masonry course.

**9.15.4.3. Foundation Walls Considered to be Laterally Supported at the Top**

1) Sentences (2) to (4) pertain to lateral support for walls described in Sentence 9.15.4.2.(1).

2) *Foundation* walls shall be considered to be laterally supported at the top if

a) such walls support a *solid masonry* superstructure or flat insulating concrete form wall,

b) the floor joists are embedded in the top of the *foundation* walls,

c) the floor system is anchored to the top of the *foundation* walls with anchor bolts, in which case the joists may run either parallel or perpendicular to the *foundation* walls, or

d) they extend from the footing to no more than 300 mm above the finished ground level and are backfilled on both sides such that the difference in elevation between the finished ground levels on either side of the wall is no more than 150 mm.

3) Unless the wall around an opening is reinforced to withstand earth pressure, the portion of the *foundation* wall beneath an opening shall be considered laterally unsupported if

a) the opening is more than 1.2 m wide, or

b) the total width of the openings in the *foundation* wall constitutes more than 25% of the length of the wall.

4) For the purposes of Sentence (3), the combined width of the openings shall be considered as a single opening if the average width is greater than the width of solid wall between them.

5) Flat insulating concrete form *foundation* walls shall be considered to be laterally supported at the top if the floor joists are installed according to Article 9.20.17.5.

**9.15.4.4. Foundation Walls Considered to be Laterally Supported at the Bottom**

1) Flat insulating concrete form *foundation* walls shall be considered to be laterally supported at the bottom where the *foundation* wall

a) supports backfill not more than 1.2 m in height,

b) is supported at the footing by a shear key and at the top by the ground floor framing, or

c) is doweled to the footing with not less than

- i) 15M bars spaced not more than 1.2 m o.c., or
- ii) 10M bars spaced not more than 600 mm o.c.

**9.15.4.5. Reinforcement for Flat Insulating Concrete Form Foundation Walls**

- 1) Horizontal reinforcement in flat insulating concrete form *foundation* walls shall
  - a) consist of
    - i) one 10M bar placed not more than 300 mm from the top of the wall, and
    - ii) 10M bars at 600 mm o.c., and
  - b) be located
    - i) in the inside half of the wall section, and
    - ii) with a minimum cover of 30 mm from the inside face of the concrete.
- 2) Vertical reinforcement in flat insulating concrete form *foundation* walls shall be
  - a) provided in accordance with
    - i) Table 9.15.4.5.-A for 150 mm walls,
    - ii) Table 9.15.4.5.-B for 190 mm walls, and
    - iii) Table 9.15.4.5.-C for 240 mm walls,
  - b) located in the inside half of the wall section with a minimum cover of 30 mm from the inside face of the concrete wall, and
  - c) where interrupted by wall openings, placed not more than 600 mm from each side of the openings.
- 3) Cold joints in flat insulating concrete form *foundation* walls shall be reinforced with no less than one 15M bar spaced at not more than 600 mm o.c. and embedded 300 mm on both sides of the joint.
- 4) Reinforcing around openings in flat insulating concrete form *foundation* walls shall comply with Article 9.20.17.3. or 9.20.17.4.

**Table 9.15.4.5.-A**

**Vertical Reinforcement for 150 mm Flat Insulating Concrete Form Foundation Walls  
Forming Part of Sentence 9.15.4.5.(2)**

Max. Height of Finished Ground Above Finished Basement Floor, m	Minimum Vertical Reinforcement		
	Maximum Unsupported <i>Basement</i> Wall Height		
	2.44 m	2.75 m	3.0 m
1.35	10M at 400 mm o.c.	10M at 400 mm o.c.	10M at 400 mm o.c.
1.6	10M at 400 mm o.c.	10M at 380 mm o.c.	10M at 380 mm o.c.
2	10M at 380 mm o.c.	10M at 380 mm o.c.	10M at 380 mm o.c.
2.2	10M at 250 mm o.c.	10M at 250 mm o.c.	10M at 250 mm o.c.
2.35	n/a	10M at 250 mm o.c.	10M at 250 mm o.c.
2.6	n/a	10M at 250 mm o.c.	10M at 250 mm o.c.
3	n/a	n/a	15M at 250 mm o.c.

**Table 9.15.4.5.-B**

**Vertical Reinforcement for 190 mm Flat Insulating Concrete Form Foundation Walls  
Forming Part of Sentence 9.15.4.5.(2)**

Max. Height of Finished Ground Above Finished Basement Floor, m	Minimum Vertical Reinforcement		
	Maximum Unsupported <i>Basement</i> Wall Height		
	2.44 m	2.75 m	3.0 m
2.2	None required	10M at 400 mm o.c.	10M at 400 mm o.c.
2.35	n/a	10M at 300 mm o.c.	10M at 300 mm o.c.
2.6	n/a	10M at 300 mm o.c.	15M at 400 mm o.c.
3.0	n/a	n/a	15M at 400 mm o.c.

**Table 9.15.4.5.-C**

**Vertical Reinforcement for 240 mm Flat Insulating Concrete Form Foundation Walls  
Forming Part of Sentence 9.15.4.5.(2)**

Max. Height of Finished Ground Above Finished Basement Floor, m	Minimum Vertical Reinforcement		
	Maximum Unsupported <i>Basement</i> Wall Height		
	2.44 m	2.75 m	3.0 m
2.2	None required	None required	None required
2.6	n/a	15M at 400 mm o.c.	15M at 400 mm o.c.
3.0	n/a	n/a	15M at 400 mm o.c.

**9.15.4.6. Extension above Ground Level**

- 1) Exterior *foundation* walls shall extend not less than 150 mm above finished ground level.

**9.15.4.7. Reduction in Thickness**

1) Where the top of a *foundation* wall is reduced in thickness to permit the installation of floor joists, the reduced section shall be not more than 350 mm high and not less than 90 mm thick.

2) Where the top of a *foundation* wall is reduced in thickness to permit the installation of a masonry exterior facing, the reduced section shall be

- a) not less than 90 mm thick, and
- b) tied to the facing material with metal ties conforming to Sentence 9.20.9.4.(3) spaced not more than
  - i) 200 mm o.c. vertically, and
  - ii) 900 mm o.c. horizontally.
- 3) The space between wall and facing described in Sentence (2) shall be filled with mortar.

**9.15.4.8. Corbelling**

1) Corbelling of masonry *foundation* walls supporting *cavity walls* shall conform to Article 9.20.12.2.

**9.15.4.9. Crack Control Joints**

1) Crack control joints shall be provided in *foundation* walls more than 25 m long at intervals of not more than 15 m.

2) Joints required in Sentence (1) shall be designed to resist moisture penetration and shall be keyed to prevent relative displacement of the wall portions adjacent to the joint.

#### **9.15.4.10. Interior Masonry Walls**

1) Interior masonry *foundation* walls not subject to lateral earth pressure shall conform to Section 9.20.

### **9.15.5. Support of Joists and Beams on Masonry Foundation Walls**

#### **9.15.5.1. Support of Floor Joists**

1) Except as permitted in Sentence (2), *foundation* walls of hollow masonry units supporting floor joists shall be capped with

- a) not less than 50 mm of concrete,
- b) *solid masonry units* that are 100% solid and not less than 50 mm high, or
- c) semi-solid or hollow *solid masonry units* that have the top course completely filled with mortar, grout or concrete.

2) Capping required in Sentence (1) need not be provided

- a) in localities where termites are not known to occur,
- b) when the joists are supported on a wood plate not less than 38 mm by 89 mm, and
- c) when the siding overlaps the *foundation* wall not less than 12 mm.

#### **9.15.5.2. Support of Beams**

1) Not less than 190 mm depth of *solid masonry* shall be provided beneath beams supported on masonry.

2) Where the beam referred to in Sentence (1) is supported below the top of the *foundation* walls, the ends of such beams shall be protected from the weather.

#### **9.15.5.3. Pilasters**

1) Pilasters shall be provided under beams that frame into unit masonry *foundation* walls 140 mm or less in thickness.

2) Pilasters required in Sentence (1) shall be not less than 90 mm by 290 mm and shall be bonded or tied into the wall.

3) The top 200 mm of pilasters required in Sentence (1) shall be *solid masonry* with the cells of hollow or semi-solid units filled with mortar, grout or concrete.

### **9.15.6. Parging and Finishing of Masonry Foundation Walls**

#### **9.15.6.1. Foundation Walls below Ground**

1) Concrete block *foundation* walls shall be parged on the exterior face below ground level as required in Section 9.13.

#### **9.15.6.2. Foundation Walls above Ground**

1) Exterior surfaces of concrete block *foundation* walls above ground level shall have tooled joints, or shall be parged or otherwise suitably finished.

### **9.15.6.3. Form Ties**

- 1) All form ties shall be removed at least flush with the concrete surface.

## **Section 9.16. Floors-on-Ground**

### **9.16.1. Scope**

#### **9.16.1.1. Application**

1) This Section applies to floors supported on ground or on granular *fill* that do not provide structural support for the superstructure.

#### **9.16.1.2. Structural Floors**

1) Floors-on-ground that support loads from the superstructure shall be designed in conformance with Part 4.

#### **9.16.1.3. Required Floors-on-Ground**

1) All spaces within *dwelling units*, except crawl spaces, shall be provided with a floor-on-ground, where

- a) access is provided to the space, and
- b) a floor supported by the structure is not provided.

#### **9.16.1.4. Dampproofing and Waterproofing**

1) Dampproofing and waterproofing shall conform to Section 9.13.

### **9.16.2. Material beneath Floors**

#### **9.16.2.1. Required Installation of Granular Material**

1) Except as provided in Sentence (2), not less than 100 mm of coarse clean granular material containing not more than 10% of material that will pass a 4 mm sieve shall be placed beneath floors-on-ground. (See Note A-9.16.2.1.(1) and see also Subsection 9.13.4. and Note A-9.13.4.)

2) Granular material need not be installed under

- a) slabs in garages, carports or accessory *buildings*, or
- b) *buildings of industrial occupancy* where the nature of the process contained therein permits or requires the use of large openings in the *building* envelope even during the winter.

#### **9.16.2.2. Support of Floors**

1) Material that is susceptible to changes in volume due to variations in moisture content or chemical-microbiological oxidation shall not be used as *fill* beneath floors-on-ground in a concentration that will damage the *building* to a degree that would adversely affect its stability or the performance of assemblies. (See also Article 9.4.4.4. and Note A-9.4.4.4.(1).)

2) Material that is susceptible to changes in volume due to freezing shall not be used as *fill* beneath floors-on-ground that will be subjected to freezing temperatures. (See also Article 9.4.4.4. and Note A-9.4.4.4.(1).)

3) Except as provided in Sentence (4), *fill* beneath floors-on-ground shall be compacted.

4) *Fill* beneath floors-on-ground need not be compacted where the material is clean coarse aggregate containing not more than 10% of material that will pass a 4 mm sieve.

### **9.16.3. Drainage**

### **9.16.3.1. Control of Water Ingress**

1) Except as provided in Article 9.16.3.2. or where it can be shown to be unnecessary, ingress of water underneath a floor-on-ground shall be prevented by grading or drainage.

### **9.16.3.2. Hydrostatic Pressure**

1) Where *groundwater levels* may cause hydrostatic pressure beneath a floor-on-ground, the floor-on-ground shall be

- a) a poured concrete slab, and
- b) designed to resist such pressures.

### **9.16.3.3. Floor Drains**

1) When floor drains are required (see Section 9.31.), the floor surface shall be sloped so that no water can accumulate.

## **9.16.4. Concrete**

### **9.16.4.1. Surface Finish**

- 1) The finished surface of concrete floor slabs shall be trowelled smooth and even.
- 2) Dry cement shall not be added to the floor surfaces to absorb surplus water.

### **9.16.4.2. Topping Course**

1) When a topping course is provided for a concrete floor slab, it shall consist of 1 part cement to 2.5 parts clean, well graded sand by volume, with a water/cement ratio approximately equal to that of the base slab.

2) When concrete topping is provided, it shall not be less than 20 mm thick.

### **9.16.4.3. Thickness**

1) Concrete slabs shall not be less than 75 mm thick exclusive of concrete topping.

### **9.16.4.4. Bond Break**

1) A bond-breaking material shall be placed between the slab and footings or *rock*.

## **9.16.5. Wood**

### **9.16.5.1. Wood-Frame Floors**

1) Floors-on-ground constructed of wood shall conform to CSA S406, "Specification of permanent wood foundations for housing and small buildings."

## **Section 9.17. Columns**

### **9.17.1. Scope**

#### **9.17.1.1. Application**

- 1) This Section applies to columns used to support
  - a) beams carrying loads from not more than 2 wood-frame floors where
    - i) the supported length of joists bearing on such beams does not exceed 5 m, and
    - ii) the *live load* on any floor does not exceed 2.4 kPa (see Table 4.1.5.3.),
  - b) beams or header joists carrying loads from not more than 2 levels of wood-frame balconies, decks or other accessible exterior platforms, or 1 level plus the roof, where



- i) the supported length of joists bearing on such beams or joists does not exceed 5 m,
  - ii) the sum of the specified snow and *occupancy* loads does not exceed 4.8 kPa (see Sentence 9.4.2.3.(1) for the determination of load on platform-type constructions), and
  - iii) the platform serves only a single *suite of residential occupancy*, or
- c) carport roofs (see Section 9.35.).
- 2) Columns for applications other than as described in Sentence (1) shall be designed in accordance with Part 4.

## **9.17.2. General**

### **9.17.2.1. Location**

- 1) Columns shall be centrally located on a footing conforming to Section 9.15.

### **9.17.2.2. Lateral Support**

- 1) Columns shall be securely fastened to the supported member to reduce the likelihood of lateral differential movement between the column and the supported member. (See also Article 9.23.6.2.)
- 2) Except as permitted by Sentence (3), columns shall be laterally supported to resist racking
  - a) directly, or
  - b) by connection to the supported members.(See Note A-9.17.2.2.(2).)
- 3) Columns need not be provided with lateral support as described in Sentence (2), where
  - a) the distance from finished ground to the underside of the joists is not more than 600 mm, and
  - b) the columns support a deck with no superstructure.

## **9.17.3. Steel Columns**

### **9.17.3.1. Size and Thickness**

- 1) Except as permitted in Sentence (2), steel pipe columns shall have an outside diameter of not less than 73 mm and a wall thickness of not less than 4.76 mm.
- 2) Columns of sizes other than as specified in Sentence (1) are permitted to be used where the *loadbearing* capacities are shown to be adequate.

### **9.17.3.2. End Bearing Plates**

- 1) Except as permitted in Sentence (2), steel columns shall be fitted with not less than 100 mm by 100 mm by 6.35 mm thick steel plates at each end, and where the column supports a wooden beam, the top plate shall extend across the full width of the beam.
- 2) The top plate required in Sentence (1) need not be provided where a column supports a steel beam and provision is made for the attachment of the column to the beam.

### **9.17.3.3. Paint**

- 1) Exterior steel columns shall be treated on the outside surface with at least one coat of rust-inhibitive paint.

### **9.17.3.4. Design of Steel Columns**

- (See Note A-9.17.3.4.)

1) Where the imposed load does not exceed 36 kN, adjustable steel columns shall conform to CAN/CGSB-7.2, "Adjustable Steel Columns."

2) Steel columns other than those described in Sentence (1) shall be designed in accordance with Part 4.

#### **9.17.4. Wood Columns**

##### **9.17.4.1. Column Sizes**

1) The width or diameter of a wood column shall be not less than the width of the supported member.

2) Except as provided in Article 9.35.4.2., columns shall be not less than 184 mm for round columns and 140 mm by 140 mm for rectangular columns, unless calculations are provided to show that lesser sizes are adequate.

##### **9.17.4.2. Materials**

1) Wood columns shall be either solid, glued-laminated or built-up.

2) Built-up columns shall consist of not less than 38 mm thick full-length members

a) bolted together with not less than 9.52 mm diam bolts spaced not more than 450 mm o.c.,  
or

b) nailed together with not less than 76 mm nails spaced not more than 300 mm o.c.

3) Glued-laminated columns shall conform to Section 4.3.

##### **9.17.4.3. Columns in Contact with Concrete**

1) Wood columns shall be separated from concrete in contact with the ground by 0.05 mm polyethylene film or Type S roll roofing.

#### **9.17.5. Unit Masonry Columns**

##### **9.17.5.1. Materials**

1) Unit masonry columns shall be built of masonry units

a) conforming to CSA A165.1, "Concrete block masonry units," and

b) having a compressive strength over the net area of the block of not less than 15 MPa.

##### **9.17.5.2. Sizes**

1) Unit masonry columns shall be not less than 290 mm by 290 mm or 240 mm by 380 mm in size.

#### **9.17.6. Solid Concrete Columns**

##### **9.17.6.1. Materials**

1) Concrete shall conform to Section 9.3.

##### **9.17.6.2. Sizes**

1) Concrete columns shall be not less than 200 mm by 200 mm for rectangular columns and 230 mm diam for circular columns.

## **Section 9.18. Crawl Spaces**

### **9.18.1. General**

### **9.18.1.1. Application**

1) This Section applies to crawl spaces whose exterior walls have less than 25% of their total area above exterior ground level open to the outdoors.

### **9.18.1.2. Foundations**

1) *Foundations* enclosing crawl spaces shall conform to Section 9.15.

### **9.18.1.3. Heated and Unheated Crawl Spaces**

1) Crawl spaces shall be considered to be heated where the space

a) is used as a hot air *plenum*,

b) contains heating ducts that are not sealed and insulated to minimize heat loss to the space, or

c) is not separated from heated space in accordance with Section 9.25.

2) Heating of heated crawl spaces shall conform to Section 9.33.

3) Insulation, an *air barrier system* and a *vapour barrier* shall be installed in the walls of heated crawl spaces in accordance with Section 9.25.

## **9.18.2. Access**

### **9.18.2.1. Access Openings**

1) An access opening of not less than 500 mm by 700 mm shall be provided to each crawl space where the crawl space serves a single *dwelling unit*, and not less than 550 mm by 900 mm for other crawl spaces.

2) Access openings shall be fitted with a door or hatch, except when the crawl space is heated and the access opening into the crawl space is from an adjacent heated space.

## **9.18.3. Ventilation**

### **9.18.3.1. Ventilation of Unheated Crawl Spaces**

1) Unheated crawl spaces shall be ventilated by natural or mechanical means.

2) Where an unheated crawl space is ventilated by natural means, ventilation shall be provided to the outside air by not less than 0.1 m<sup>2</sup> of unobstructed vent area for every 50 m<sup>2</sup> of *floor area*.

3) Vents shall be

a) uniformly distributed on opposite sides of the *building*, and

b) designed to prevent the entry of snow, rain and insects.

### **9.18.3.2. Ventilation of Heated Crawl Spaces**

1) Heated crawl spaces shall be ventilated in accordance with Section 9.32.

## **9.18.4. Clearance**

(See also Article 9.3.2.9.)

### **9.18.4.1. Access Way to Services**

1) Where equipment requiring service such as plumbing cleanouts, traps and burners is located in crawl spaces, an access way with a height and width of not less than 600 mm shall be

provided from the access door to the equipment and for a distance of 900 mm on the side or sides of the equipment to be serviced.

### **9.18.5. Drainage**

#### **9.18.5.1. Drainage**

- 1) Except where it can be shown to be unnecessary, the ingress of water into a crawl space shall be controlled by grading or drainage.
- 2) Drainage of *foundation* walls shall conform to Article 9.14.2.1.
- 3) Drainage of the ground cover or floor-on-ground in the crawl space shall conform to Subsection 9.16.3.
- 4) Drains shall conform to Section 9.14.

### **9.18.6. Ground Cover**

#### **9.18.6.1. Ground Cover in Unheated Crawl Spaces**

- 1) Where a crawl space is unheated, a ground cover shall be provided consisting of not less than
  - a) 50 mm of asphalt,
  - b) 100 mm of 15 MPa Portland cement concrete,
  - c) Type S roll roofing, or
  - d) 0.10 mm polyethylene.
- 2) Joints in sheet-type ground cover required in Sentence (1) shall be lapped not less than 100 mm and weighted down.

#### **9.18.6.2. Ground Cover in Heated Crawl Spaces**

- 1) Where a crawl space is heated, a ground cover consisting of not less than 0.15 mm polyethylene sheet conforming to CAN/CGSB-51.34-M, "Vapour Barrier, Polyethylene Sheet for Use in Building Construction," shall be installed as part of an *air barrier system* in accordance with Subsection 9.25.3.
  - 2) The ground cover required in Sentence (1) shall have its joints lapped not less than 300 mm, and
    - a) be sealed and evenly weighted down, or
    - b) be covered with concrete not less than 50 mm thick.
  - 3) The perimeter of the ground cover required in Sentence (1) shall be sealed to the *foundation* wall. (See Notes A-9.13.4., A-9.25.3.4. and 9.25.3.6., and A-9.25.3.6.(2) and (3).)
  - 4) All penetrations of the ground cover required in Sentence (1) shall be sealed against air leakage. (See Subsection 9.25.3.)

### **9.18.7. Fire Protection**

#### **9.18.7.1. Crawl Spaces as Warm Air Plenums**

- 1) Only crawl spaces under 1-storey portions of *dwelling units* shall be used as warm-air plenums.
- 2) Enclosing material in crawl spaces described in Sentence (1), including insulation, shall have a surface *flame-spread rating* not greater than 150.

3) *Combustible* ground cover in crawl spaces described in Sentence (1) shall be protected beneath each register opening with *noncombustible* material.

4) The *noncombustible* register protection described in Sentence (3) shall

- a) extend not less than 300 mm beyond the projection of the register opening, and
- b) have up-turned edges.

(See Note A-9.18.7.1.(4).)

## **Section 9.19. Roof Spaces**

### **9.19.1. Venting**

#### **9.19.1.1. Required Venting**

1) Except where it can be shown to be unnecessary, where insulation is installed between a ceiling and the underside of the roof sheathing, a space shall be provided between the insulation and the sheathing, and vents shall be installed to permit the transfer of moisture from the space to the exterior. (See Note A-9.19.1.1.(1).)

#### **9.19.1.2. Vent Requirements**

1) Except as provided in Sentence (2), the unobstructed vent area shall be not less than 1/300 of the insulated ceiling area.

2) Where the roof slope is less than 1 in 6 or in roofs that are constructed with roof joists, the unobstructed vent area shall be not less than 1/150 of the insulated ceiling area.

3) Required vents may be roof type, eave type, gable-end type or any combination thereof, and shall be distributed

- a) uniformly on opposite sides of the *building*,
- b) with not less than 25% of the required openings located at the top of the space, and
- c) with not less than 25% of the required openings located at the bottom of the space.

4) Except where each joist space is separately vented, roof joist spaces shall be interconnected by installing purlins not less than 38 mm by 38 mm on the top of the roof joists.

5) Vents shall comply with CAN3-A93-M, "Natural Airflow Ventilators for Buildings."

#### **9.19.1.3. Clearances**

1) Except as provided in Sentence (2), not less than 63 mm of space shall be provided between the top of the insulation and the underside of the roof sheathing.

2) At the junction of sloped roofs and exterior walls, where preformed baffles are used to contain the insulation, the baffles shall

a) provide an unobstructed air space, between the insulation and the underside of the roof sheathing, that is

- i) not less than 25 mm in dimension, and
- ii) of sufficient cross area to meet the *attic or roof space* venting requirements of Article 9.19.1.2., and

b) extend vertically not less than 50 mm above the top of the insulation.

3) Ceiling insulation shall be installed in a manner that will not restrict the free flow of air through roof vents or through any portion of the *attic or roof space*.

#### **9.19.1.4. Mansard or Gambrel Roof**

- 1) The lower portion of a mansard or gambrel style roof need not be ventilated.
- 2) The upper portion of roofs described in Sentence (1) shall be ventilated in conformance with Articles 9.19.1.1. to 9.19.1.3.

#### **9.19.2. Access**

##### **9.19.2.1. Access**

1) Every *attic or roof space* shall be provided with an access hatch where the open space in the *attic or roof space* measures

- a) 3 m<sup>2</sup> or more in area,
- b) 1 m or more in length or width, and
- c) 600 mm or more in height over at least the area described in Clauses (a) and (b).

(See Note A-9.19.2.1.(1).)

2) The hatch required in Sentence (1) shall be not less than 550 mm by 900 mm except that, where the hatch serves not more than one *dwelling unit*, the hatch may be reduced to 0.32 m<sup>2</sup> in area with no dimension less than 500 mm.

3) Hatchways to *attic or roof spaces* shall be fitted with doors or covers.

## **Section 9.20. Masonry and Insulating Concrete Form Walls Not In Contact with the Ground**

### **9.20.1. Application**

#### **9.20.1.1. General**

- 1) Except as provided in Article 9.20.1.2., this Section applies to
  - a) unreinforced masonry and masonry veneer walls not in contact with the ground, where
    - i) the height of the walls constructed on the *foundation* walls does not exceed 11 m, and
    - ii) the roof or floor assembly above the *first storey* is not of concrete construction, and
  - b) flat insulating concrete form walls not in contact with the ground that (see Note A-9.15.1.1.(1)(c) and 9.20.1.1.(1)(b))
    - i) have a maximum floor-to-floor height of 3 m,
    - ii) are erected in *buildings* not more than 2 *storeys* in *building height*, and
    - iii) are erected in locations where the seismic design parameter,  $S_{max}$ , for Site Class C is not greater than 0.27 (see also Article 9.4.2.5.).
- 2) For walls other than those described in Sentence (1), or where the masonry walls or insulating concrete form walls not in contact with the ground are designed for specified loads on the basis of ultimate and serviceability limit states, Subsection 4.3.2. shall apply.

#### **9.20.1.2. Earthquake Reinforcement**

(See also Article 9.4.2.5.)

1) In locations where the seismic design parameter,  $S_{max}$ , for Site Class C is greater than 0.37, *loadbearing* elements of masonry *buildings* more than 1 *storey* in *building height* shall be reinforced with not less than the minimum amount of reinforcement required by Subsection 9.20.15.

2) In locations where the seismic design parameter,  $S_{max}$ , for Site Class C is greater than 0.23 but not greater than 0.37, *loadbearing* elements of masonry *buildings* 3 *storeys* in *building height* shall be reinforced with not less than the minimum amount of reinforcement required by Subsection 9.20.15.

**9.20.2. Masonry Units**

**9.20.2.1. Masonry Unit Standards**

- 1) Masonry units shall comply with
  - a) ASTM C73, "Standard Specification for Calcium Silicate Brick (Sand-Lime Brick),"
  - b) ASTM C126, "Ceramic Glazed Structural Clay Facing Tile, Facing Brick, and Solid Masonry Units,"
  - c) ASTM C212, "Standard Specification for Structural Clay Facing Tile,"
  - d) CAN/CSA-A82, "Fired masonry brick made from clay or shale,"
  - e) CSA A165.1, "Concrete block masonry units,"
  - f) CSA A165.2, "Concrete brick masonry units," or
  - g) CSA A165.3, "Prefaced concrete masonry units."

**9.20.2.2. Used Brick**

1) Used bricks shall be free of old mortar, soot or other surface coating and shall conform to Article 9.20.2.1.

**9.20.2.3. Glass Blocks**

1) Glass blocks shall not be used as *loadbearing* units or in the construction of fireplaces or *chimneys*.

**9.20.2.4. Cellular Concrete**

1) Masonry made with cellular concrete shall not be used in contact with the *soil* or exposed to the weather.

**9.20.2.5. Stone**

1) Stone shall be sound and durable.

**9.20.2.6. Concrete Blocks Exposed to the Weather**

1) Concrete blocks exposed to the weather shall have density and water absorption characteristics conforming to concrete types A, B, C, or D described in CSA A165.1, "Concrete block masonry units."

**9.20.2.7. Compressive Strength**

1) The compressive strength of concrete blocks shall conform to Table 9.20.2.7.

**Table 9.20.2.7.**

**Compressive Strength of Concrete Blocks**

**Forming Part of Sentence 9.20.2.7.(1)**

Type of Unit	Minimum Compressive Strength Over Net Area, MPa
--------------	---

	Exposed to Weather	Not Exposed to Weather
Solid or hollow concrete blocks	15	10
Solid <i>loadbearing</i> cellular blocks	Not permitted	5
Solid non- <i>loadbearing</i> cellular blocks	Not permitted	2

### 9.20.3. Mortar

#### 9.20.3.1. Mortar Materials

- 1) Cementitious materials and aggregates for mortar and grout shall comply with CAN/CSA-A179, "Mortar and Grout for Unit Masonry."
- 2) Water and aggregate shall be clean and free of significant amounts of deleterious materials.
- 3) Lime used in mortar shall be hydrated.
- 4) If lime putty is used in mortar, it shall be made by slaking quicklime in water for not less than 24 h or soaking hydrated lime in water for not less than 12 h.

#### 9.20.3.2. Mortar and Grout Mixes

- 1) Mortar types shall be in accordance with Table 9.20.3.2.-A.
- 2) Mortar for glass block masonry shall be
  - a) Type S Portland cement-lime where exposed to the exterior, or
  - b) Type S or N where protected from the exterior.
- 3) Mortar shall be mixed within the proportion limits provided in Table 9.20.3.2.-B, with sufficient water to bring the mixture to a consistency adequate for laying masonry units.
- 4) Grout shall be mixed within the proportion limits provided in Table 9.20.3.2.-C, with sufficient water to provide a suitable flow to fill all voids completely, without excessive segregation or bleeding.
- 5) Except as provided in Sentence (6), mortar shall be used and placed in final position
  - a) within 1.5 h after mixing when the air temperature is 25°C or higher, or
  - b) within 2.5 h after mixing when the air temperature is less than 25°C.
- 6) Mortar and grout containing a set-control admixture shall be manufactured off-site in a batching plant and shall be used and placed in final position within a time not exceeding the useful life stipulated by the manufacturer.
- 7) Grout used for reinforced masonry shall be placed in accordance with the requirements of CAN/CSA-A371, "Masonry Construction for Buildings."

**Table 9.20.3.2.-A**

#### Mortar Use

##### Forming Part of Sentence 9.20.3.2.(1)

Location	Building Element	Mortar Type
Exterior, Above Ground	<i>Loadbearing</i> walls and columns	S
	Non- <i>loadbearing</i> walls and columns	N or S
	Parapets, <i>chimneys</i> , masonry veneer	N or S



Exterior, At or Below Ground	Foundation walls and columns	S
Interior	Loadbearing walls and columns	N
	Non-loadbearing walls and columns	N

**Table 9.20.3.2.-B**

**Mortar Mix Proportions (by volume)**

**Forming Part of Sentence 9.20.3.2.(3)**

Mortar Type	Portland Cement	Lime	Masonry Cement Type N	Masonry Cement Type S	Fine Aggregate (damp, loose-state sand)
Type S	1	½	–	–	3½ to 4½
	–	–	–	1	2¼ to 3
	½	–	1	–	3½ to 4½
Type N	1	1	–	–	4½ to 6
	–	–	1	–	2¼ to 3

**Table 9.20.3.2.-C**

**Grout Mix Proportions (by volume)**

**Forming Part of Sentence 9.20.3.2.(4)**

Portland Cement	Lime	Fine Aggregate (sand)	Coarse Aggregate
1	0 to 1/10	2¼ to 3 times the sum of the cement and lime volumes	1 to 2 times the sum of the cement and lime volumes

**9.20.4. Mortar Joints**

**9.20.4.1. Thickness**

1) Except as provided in Sentence (2), mortar joint thickness for burned clay brick and concrete masonry units shall be 10 mm.

2) Permitted tolerances in head and bed joints shall be not more than ± 5 mm.

**9.20.4.2. Masonry Units**

1) Hollow masonry units shall be laid with mortar applied to head and bed joints of both inner and outer face shells.

2) Vertically aligned webs of hollow masonry units shall be laid in a full bed of mortar

a) under the starting course,

b) in all courses of columns, and

c) where adjacent to cells or cavities that are to be filled with grout.

3) Except for head joints left open for weep holes and ventilation, *solid masonry units* shall be laid with full head and bed joints.

**9.20.5. Masonry Support**

**9.20.5.1. Masonry Support**

1) All masonry shall be supported on masonry, concrete or steel, except that masonry veneer walls may be supported on *foundations* of wood frame constructed in conformance with Sentence 9.15.2.4.(1). (See Note A-9.20.5.1.(1).)

2) Every masonry wall shall be at least as thick as the wall it supports, except as otherwise permitted in Article 9.20.12.2.

**9.20.5.2. Lintels or Arches**

1) Masonry over openings shall be supported by steel, masonry or reinforced concrete lintels, or masonry arches.

2) Steel angle lintels supporting masonry veneer above openings shall

- a) conform to Table 9.20.5.2., and
- b) have a bearing length not less than 90 mm.

**Table 9.20.5.2.**

**Maximum Allowable Spans for Steel Lintels Supporting Masonry Veneer  
Forming Part of Sentence 9.20.5.2.(2)**

Minimum Angle Size, mm			Maximum Allowable Spans, m		
Vertical Leg	Horizontal Leg	Thickness	Supporting 75 mm Brick	Supporting 90 mm Brick	Supporting 100 mm Stone
89	76	6.4	2.55	—	—
89	89	6.4	2.59	2.47	2.30
102	89	6.4	2.79	2.66	2.48
127	89	7.9	3.47	3.31	3.08
127	89	11	3.64	3.48	3.24

3) Steel angle lintels supporting masonry other than veneer, masonry and reinforced concrete lintels, and masonry arches shall be designed in accordance with Part 4 to support the imposed load.

4) Steel angle lintels supporting masonry shall be prime painted or otherwise protected from corrosion.

**9.20.6. Thickness and Height**

**9.20.6.1. Thickness of Exterior Walls**

1) Masonry exterior walls, other than *cavity walls*, in *1-storey buildings* and the top *storeys* of *2- and 3-storey buildings* shall be not less than 140 mm thick, provided the walls are not more than 2.8 m high at the eaves and 4.6 m high at the peaks of gable ends.

2) The exterior walls of the bottom *storeys* of *2-storey buildings*, and exterior walls of the bottom 2 *storeys* of *3-storey buildings* shall be not less than 190 mm thick.

3) In exterior walls composed of more than one wythe, each wythe shall be not less than 90 mm thick.

**9.20.6.2. Cavity Walls**

1) *Cavity walls* shall be made with not less than 90 mm wide units if the joints are raked and not less than 75 mm wide units if the joints are not raked.

2) The width of a cavity in a *cavity wall* shall be not less than 50 mm and not greater than 150 mm.

3) The minimum thickness of *cavity walls* above the supporting base shall be 230 mm for the top 7.6 m and 330 mm for the remaining portion, except that where 75 mm wide units are used, the wall height above the top of the *foundation* wall shall not exceed 6 m.

#### **9.20.6.3. Thickness of Interior Walls**

1) The thickness of *loadbearing* interior walls shall be determined on the basis of the maximum lateral support spacing as provided in Sentences 9.20.10.1.(2) and (3).

2) The thickness of interior non-*loadbearing* walls shall be

a) determined on the basis of the maximum lateral support spacing as provided in Sentences 9.20.10.1.(2) and (3), and

b) in any case, not less than 65 mm.

#### **9.20.6.4. Masonry Veneer**

1) Except for masonry veneer where each masonry unit is supported individually by the structural backing, masonry veneer shall consist of *solid masonry units* not less than 75 mm thick.

2) Veneer described in Sentence (1) over wood-frame walls shall have not less than a 25 mm air space behind the veneer.

3) Masonry veneer less than 90 mm thick shall have unraked joints.

4) Masonry veneer shall conform to Subsection 4.3.2., where the masonry units are required to be individually supported by the structural backing.

#### **9.20.6.5. Parapet Walls**

1) The height of parapet walls above the adjacent roof surface shall be not more than 3 times the parapet wall thickness.

2) Parapet walls shall be *solid masonry*

a) with the cells of hollow or semi-solid units filled with mortar, grout, or concrete, and

b) that extends from the top of the parapet to not less than 300 mm below the adjacent roof level.

#### **9.20.6.6. Stone or Concrete Facings**

1) Slab and panel facings of precast concrete and natural or artificial stone shall conform to Subsection 4.3.2.

### **9.20.7. Chases and Recesses**

#### **9.20.7.1. Maximum Dimensions**

1) Except as permitted in Sentence 9.20.7.2.(2) and Article 9.20.7.4., the depth of any chase or recess shall not exceed one third the thickness of the wall, and the width of the chase or recess shall not exceed 500 mm.

#### **9.20.7.2. Minimum Wall Thickness**

1) Except as permitted in Sentence (2) and Article 9.20.7.4., no chase or recess shall be constructed in any wall 190 mm or less in thickness.

2) Recesses may be constructed in 190 mm walls provided they do not exceed 100 mm in depth, 750 mm in height and 500 mm in width.

### **9.20.7.3. Separation of Chases or Recesses**

- 1) Chases and recesses shall be not less than
  - a) 4 times the wall thickness apart, and
  - b) 600 mm away from any pilaster, cross wall, buttress or other vertical element providing required lateral support for the wall.

### **9.20.7.4. Non-Conforming Chases or Recesses**

- 1) Chases or recesses that do not conform to the limits specified in Articles 9.20.7.1. to 9.20.7.3. shall be considered as openings, and any masonry supported above such a chase or recess shall be supported by a lintel or arch as provided in Article 9.20.5.2.

### **9.20.7.5. Chases or Recesses Cut into Walls**

- 1) Chases and recesses shall not be cut into walls made with hollow units after the masonry units are in place.

## **9.20.8. Support of Loads**

### **9.20.8.1. Capping of Hollow Masonry Walls**

- 1) Except as permitted in Sentence (2), *loadbearing* walls of hollow masonry units supporting roof or floor framing members shall be capped with not less than 50 mm of *solid masonry* or have the top course filled with concrete.
- 2) Capping required in Sentence (1) may be omitted where the roof framing is supported on a wood plate not less than 38 mm by 89 mm.

### **9.20.8.2. Cavity Walls Supporting Framing Members**

- 1) Floor joists supported on *cavity walls* shall be supported on *solid masonry units* not less than 57 mm high.
- 2) Floor joists described in Sentence (1) shall not project into the cavity.
- 3) Roof and ceiling framing members bearing on *cavity walls* shall be supported on
  - a) *solid masonry units* not less than 57 mm high that bridge the full thickness of the wall, or
  - b) a wood plate not less than 38 mm thick, bearing not less than 50 mm on each wythe.

### **9.20.8.3. Bearing of Beams and Joists**

- 1) The bearing area under beams and joists shall be sufficient to carry the supported load.
- 2) In no case shall the minimum length of end bearing of beams supported on masonry be less than 90 mm.
- 3) The length of end bearing of floor, roof or ceiling joists supported on masonry shall be not less than 40 mm.

### **9.20.8.4. Support of Beams and Columns**

- 1) Beams and columns supported on masonry walls shall be supported on pilasters where the thickness of the masonry wall or wythe is less than 190 mm.
- 2) Not less than 190 mm depth of *solid masonry* or concrete shall be provided under the beam or column referred to in Sentence (1).
- 3) Pilasters required in Sentence (1) shall be bonded or tied to masonry walls.
- 4) Concrete pilasters required in Sentence (1) shall be not less than 50 mm by 300 mm.

5) Unit masonry pilasters required in Sentence (1) shall be not less than 100 mm by 290 mm.

#### **9.20.8.5. Projection of Masonry Veneer Beyond Supporting Members**

1) Masonry veneer of *solid masonry units* resting on a bearing support shall not project more than one third of the thickness of the veneer. (See Note A-9.20.8.5.(1).)

2) Where the masonry veneer described in Sentence (1) is rough stone masonry,

a) the projection shall be measured as the average projection of the units, and

b) the thickness of the veneer shall be measured as the average thickness of the veneer.

#### **9.20.9. Bonding and Tying**

##### **9.20.9.1. Joints to be Offset or Reinforced**

1) Vertical joints in adjacent masonry courses shall be offset unless each wythe of masonry is reinforced with the equivalent of not less than 2 corrosion-resistant steel bars of 3.76 mm diam placed in the horizontal joints at vertical intervals not exceeding 460 mm.

2) Where joints in the reinforcing referred to in Sentence (1) occur, the bars shall be lapped not less than 150 mm.

##### **9.20.9.2. Bonding or Tying of Other than Masonry Veneer**

1) Except as provided in Article 9.20.9.5. regarding masonry veneer, masonry walls that consist of 2 or more wythes shall have the wythes bonded or tied together with masonry bonding units as described in Article 9.20.9.3. or with metal ties as described in Article 9.20.9.4.

##### **9.20.9.3. Bonding**

1) Where wythes are bonded together with masonry units, the bonding units shall comprise not less than 4% of the wall surface area.

2) Bonding units described in Sentence (1) shall be spaced not more than 600 mm vertically and horizontally in the case of brick masonry and 900 mm o.c. in the case of block or tile.

3) Units described in Sentence (1) shall extend not less than 90 mm into adjacent wythes.

##### **9.20.9.4. Tying**

1) Where 2 or more wythes are tied together with metal ties of the individual rod type, the ties shall conform to the requirements in Sentences (3) to (6).

2) Other ties may be used where it can be shown that such ties provide walls that are at least as strong and as durable as those made with the individual rod type.

3) Metal ties of the individual rod type shall

a) be corrosion-resistant,

b) have a minimum cross-sectional area of not less than 17.8 mm<sup>2</sup>, and

c) have not less than a 50 mm portion bent at right angles at each end.

4) Metal ties of the individual rod type shall

a) extend from within 25 mm of the outer face of the wall to within 25 mm of the inner face of the wall,

b) be completely embedded in mortar except for the portion exposed in *cavity walls*, and

c) be staggered from course to course.

5) Where 2 or more wythes in walls other than *cavity walls* and masonry veneer/masonry backing walls are tied together with metal ties of the individual rod type, the space between wythes shall be completely filled with mortar.

6) Ties described in Sentence (5) shall be

a) located within 300 mm of openings and spaced not more than 900 mm apart around openings, and

b) spaced not more than 900 mm apart horizontally and 460 mm apart vertically at other locations.

7) Except as required in Sentences (8) and (9), where the inner and outer wythes of *cavity walls* are tied with individual wire ties, the ties shall be spaced not more than 900 mm apart horizontally and 400 mm apart vertically.

8) Within 100 mm of the bottom of each floor or roof assembly where the cavity extends below the assemblies, the ties described in Sentence (7) shall be spaced not more than 600 mm apart horizontally.

9) Within 300 mm of any openings, the ties described in Sentence (7) shall be spaced not more than 900 mm apart.

**9.20.9.5. Ties for Masonry Veneer**

1) Masonry veneer 75 mm or more in thickness and resting on a bearing support shall be tied to masonry backing or to wood framing members with straps that are

a) corrosion-resistant,

b) not less than 0.76 mm thick,

c) not less than 22 mm wide,

d) shaped to provide a key with the mortar,

e) pre-bent during manufacture to a right angle within 6 mm of the fastener hole,

f) fastened with

i) corrosion-resistant wood screws conforming to Sentence 9.23.3.1.(3) that have a minimum diameter of 4.16 mm (No. 8) and a wood penetration of not less than 38 mm, or

ii) corrosion-resistant common spiral nails conforming to Sentence 9.23.3.1.(1) that are not less than 76 mm long and have a wood penetration of not less than 63 mm, and

g) spaced in accordance with Table 9.20.9.5.

**Table 9.20.9.5.**

**Veneer Tie Spacing**

**Forming Part of Sentence 9.20.9.5.(1)**

Maximum Vertical Spacing, mm	Maximum Horizontal Spacing, mm
400	800
500	600
600	400

2) Where hot-dipped, zinc-coated straps are used to meet the requirements of Sentence (1), they shall be pre-bent and pre-drilled or pre-punched prior to hot-dip, zinc-coated galvanizing.

3) Masonry veneer individually supported by masonry or wood-frame backing shall be secured to the backing in conformance with Subsection 4.3.2.

#### **9.20.9.6. Reinforcing for Glass Block**

1) Glass block shall have horizontal joint reinforcement of 2 corrosion-resistant bars of not less than 3.76 mm diam or expanded metal strips not less than 75 mm wide

a) spaced at vertical intervals of not more than 600 mm for units 200 mm or less in height, and

b) installed in every horizontal joint for units higher than 200 mm.

2) Reinforcement required in Sentence (1) shall be lapped not less than 150 mm.

#### **9.20.10. Lateral Support**

##### **9.20.10.1. Lateral Support Required**

1) Masonry walls shall be laterally supported by floor or roof construction or by intersecting masonry walls or buttresses.

2) The spacing of supports required in Sentence (1) shall be not more than

a) 20 times the wall thickness for all *loadbearing* walls and exterior non-*loadbearing* walls, and

b) 36 times the wall thickness for interior non-*loadbearing* walls.

3) In applying Sentence (2), the thickness of *cavity walls* shall be taken as the greater of

a) two-thirds of the sum of the thicknesses of the wythes, or

b) the thickness of the thicker wythe.

4) Floor and roof constructions providing lateral support for walls as required in Sentence (1) shall be constructed to transfer lateral loads to walls or buttresses approximately at right angles to the laterally supported walls.

#### **9.20.11. Anchorage of Roofs, Floors and Intersecting Walls**

##### **9.20.11.1. Anchorage to Floor or Roof Assemblies where Masonry Walls Require Lateral Support**

1) Where required to receive lateral support (see Subsection 9.20.10.), masonry walls shall be anchored to each floor or roof assembly at maximum intervals of 2 m, except that anchorage to floor joists not more than 1 m above *grade* may be omitted.

2) Anchors required in Sentence (1) shall be corrosion-resistant and be not less than the equivalent of 40 mm by 4.76 mm thick steel straps.

3) Anchors required in Sentence (1) shall be shaped to provide a mechanical key with the masonry and shall be securely fastened to the horizontal support to develop the full strength of the anchor.

4) When joists are parallel to the wall, anchors required in Sentence (1) shall extend across not less than 3 joists.

##### **9.20.11.2. Bonding and Tying Intersecting Masonry Walls where Walls Require Lateral Support**

1) Where required to provide lateral support, intersecting walls shall be bonded or tied together.

2) Where bonding is used to satisfy the requirements of Sentence (1), 50% of the adjacent masonry units in the intersecting wall, distributed uniformly over the height of the intersection, shall be embedded in the laterally supported wall.

3) Where tying is used to satisfy the requirements of Sentence (1), the ties shall be

a) corrosion-resistant metal,

b) equivalent to not less than 4.76 mm by 40 mm steel strapping,

c) spaced not more than 800 mm o.c. vertically, and

d) shaped at both ends to provide sufficient mechanical key to develop the strength of the ties.

#### **9.20.11.3. Anchoring Intersecting Wood-Frame Walls to Masonry Walls**

1) Wood-frame walls shall be anchored to masonry walls that they intersect with not less than 4.76 mm diam corrosion-resistant steel rods spaced not more than 900 mm o.c. vertically.

2) Anchors required in Sentence (1) shall be fastened to the wood framing at one end and shaped to provide a mechanical key at the other end to develop the strength of the anchor.

#### **9.20.11.4. Anchoring Wood-Frame Roof Systems to Masonry Walls**

1) Except as permitted in Sentence (2), roof systems of wood-frame construction shall be anchored to exterior masonry walls by not less than 12.7 mm diam anchor bolts,

a) spaced not more than 2.4 m apart,

b) embedded not less than 90 mm into the masonry, and

c) fastened to a rafter plate of not less than 38 mm thick lumber.

2) The roof system described in Sentence (1) is permitted to be anchored by nailing the wall furring strips to the side of the rafter plate.

#### **9.20.11.5. Anchoring Masonry Cornices, Sills and Trim to Masonry Walls**

1) Cornices, sills or other trim of masonry material which project beyond the wall face shall have not less than 65% of their mass, but not less than 90 mm, within the wall or shall be adequately anchored to the wall with corrosion-resistant anchors.

#### **9.20.11.6. Anchoring to Masonry Piers**

1) Where anchor bolts are to be placed in the top of a masonry pier, the pier shall conform to the requirements of Sentence 9.15.2.3.(4) and shall be capped with concrete or reinforced masonry not less than 200 mm thick.

### **9.20.12. Corbelling**

#### **9.20.12.1. Corbelling**

1) All corbelling shall consist of *solid masonry units*.

2) The units referred to in Sentence (1) shall be corbelled so that the horizontal projection of any unit does not exceed 25 mm and the total projection does not exceed one third of the total wall thickness.

#### **9.20.12.2. Corbelling for Cavity Walls**

1) *Cavity walls* of greater thickness than the *foundation* wall on which they rest shall not be corbelled but may project 25 mm over the outer face of the *foundation* wall disregarding parging.



2) Where the *foundation* wall referred to in Sentence (1) is unit masonry, it is permitted to be corbelled to meet flush with the inner face of a *cavity wall* provided

a) the projection of each course does not exceed half the height or one third the thickness of the corbelled unit, and

b) the total corbel does not exceed one third of the *foundation* wall thickness.

(See Note A-9.20.12.2.(2).)

### 9.20.12.3. Corbelling for Masonry Veneer

1) Masonry veneer resting on a bearing support shall not project more than 25 mm beyond the supporting base where the veneer is not less than 90 mm thick, and 12 mm beyond the supporting base where the veneer is less than 90 mm thick.

2) In the case of rough stone veneer, the projection, measured as the average projection of the stone units, shall not exceed one-third the bed width beyond the supporting base.

## 9.20.13. Control of Rainwater Penetration

### 9.20.13.1. Materials for Flashing

1) Materials used for flashing shall conform to Table 9.20.13.1.

**Table 9.20.13.1.**

#### Flashing Materials

#### Forming Part of Sentence 9.20.13.1.(1)

Material	Minimum Thickness, mm	
	Exposed Flashing	Concealed Flashing
Aluminum	0.48	—
Copper	0.46	0.46
Copper or aluminum laminated to felt or kraft paper	—	0.05
Galvanized steel	0.33	0.33
Lead sheet	1.73	1.73
Polyethylene	—	0.50
Roll roofing, Type S	—	standard
Zinc	0.46	0.46

2) Aluminum flashing in contact with masonry or concrete shall be effectively coated or separated from the masonry or concrete by an impervious membrane.

### 9.20.13.2. Fastening of Flashing

1) Fastening devices for flashing shall be corrosion-resistant and, where metal flashing is used, shall be compatible with the flashing with respect to galvanic action.

### 9.20.13.3. Location of Flashing

1) Flashing shall be installed in masonry and masonry veneer walls

a) beneath jointed masonry window sills,

b) over the back and top of parapet walls,

c) over the heads of glass block panels,

- d) beneath weep holes, and
- e) over the heads of window or door openings in exterior walls when the vertical distance between the top of a window or door frame and the bottom edge of the eave exceeds one-quarter of the horizontal eave overhang.

#### **9.20.13.4. Extension of Flashing**

- 1) When installed beneath jointed masonry window sills or over the heads of openings, flashing shall extend from the front edge of the masonry up behind the sill or lintel.

#### **9.20.13.5. Flashing for Weep Holes in Masonry/Masonry Walls**

- 1) Flashing beneath weep holes in *cavity walls* and masonry veneer/masonry backing walls shall
  - a) be bedded not less than 25 mm in the inside wythe,
  - b) extend to not less than 5 mm beyond the outer face of the *building* element below the flashing, and
  - c) be installed with a nominally horizontal slope toward the outside wythe.

#### **9.20.13.6. Flashing for Weep Holes in Masonry Veneer**

- 1) Flashing beneath weep holes in masonry veneer over masonry backing walls shall conform to the flashing requirements for *cavity walls* and masonry veneer/masonry backing walls in Article 9.20.13.5.
- 2) Flashing beneath weep holes in masonry veneer over wood-frame walls shall be installed so that it extends from a point not less than 5 mm beyond the outer face of the *building* element below the flashing to a point 150 mm up the wood-frame wall.
- 3) Where the frame wall is sheathed with a sheathing membrane, a non-wood-based rigid exterior insulating sheathing or a semi-rigid insulating sheathing with an integral sheathing membrane, the flashing shall be installed behind the sheathing membrane or insulating sheathing.
- 4) Flashing described in Sentence (2) is permitted to conform to the requirements for concealed flashing in Table 9.20.13.1.

#### **9.20.13.7. Flashing Joints**

- 1) Joints in flashing shall be made watertight.

#### **9.20.13.8. Required Weep Holes**

- 1) Weep holes spaced not more than 800 mm apart shall be provided at the bottom of
  - a) cavities in *cavity walls*, and
  - b) cavities or air spaces in masonry veneer walls.
- 2) The cavities or air spaces described in Sentence (1) shall include those above lintels over window and door openings required to be flashed in conformance with Article 9.20.13.3.

#### **9.20.13.9. Protection of Interior Finish**

- 1) Except as provided in Sentence (3), where the interior finish of the exterior walls of a *building* is a type that may be damaged by moisture, exterior masonry walls, other than *cavity walls* or walls that are protected for their full height by a roof of a carport or porch, shall be covered on the interior surface with sheathing membrane conforming to CAN/CGSB-51.32-M, "Sheathing, Membrane, Breather Type," lapped not less than 100 mm at the joints.

2) In situations described in Sentence (1), flashing shall be provided where water will accumulate, to lead it to the exterior.

3) Where insulation that effectively limits the passage of water is applied by a waterproof adhesive or mortar directly to parged masonry, the requirements for sheathing membrane in Sentence (1) do not apply. (See Note A-9.20.13.9.(3).)

#### **9.20.13.10. Mortar Droppings**

1) *Cavity walls* shall be constructed so that mortar droppings are prevented from forming a bridge to allow the passage of rain water across the cavity.

#### **9.20.13.11. Caulking at Door and Window Frames**

1) The junction of door and window frames with masonry shall be caulked in conformance with Subsection 9.27.4.

#### **9.20.13.12. Drips beneath Window Sills**

1) Where no flashing is installed beneath window sills, such sills shall be provided with a drip not less than 25 mm from the wall surface.

### **9.20.14. Protection during Work**

#### **9.20.14.1. Laying Temperature of Mortar and Masonry**

1) Mortar and masonry shall be maintained at a temperature not below 5°C during installation and for not less than 48 h after installation.

2) No frozen material shall be used in mortar mix.

#### **9.20.14.2. Protection from Weather**

1) The top surface of uncompleted masonry exposed to the weather shall be completely covered with a waterproofing material when construction is not in progress.

### **9.20.15. Reinforcement for Earthquake Resistance**

#### **9.20.15.1. Amount of Reinforcement**

1) Where reinforcement is required in this Section, masonry walls shall be reinforced horizontally and vertically with steel having a total cross-sectional area of not less than 0.002 times the horizontal cross-sectional area of the wall, so that not less than one-third of the required steel area is installed either horizontally or vertically and the remainder in the other direction.

#### **9.20.15.2. Installation Standard**

1) Where reinforcement for masonry is required in this Section, it shall be installed in conformance with the requirements for reinforced masonry as contained in CAN/CSA-A371, "Masonry Construction for Buildings."

### **9.20.16. Corrosion Resistance**

#### **9.20.16.1. Corrosion Resistance of Connectors**

1) Carbon steel connectors required to be corrosion-resistant shall be galvanized to at least the minimum standards in Table 9.20.16.1.

**Table 9.20.16.1.**

**Minimum Requirements for Galvanizing  
Forming Part of Sentence 9.20.16.1.(1)**

Connector Material	ASTM Standard	Coating Class or Thickness
--------------------	---------------	----------------------------

Wire ties and continuous reinforcing (hot-dipped galvanizing)	ASTM A153/A153M	Class B2 or 458 g/m <sup>2</sup>
Hardware and bolts	ASTM A153/A153M	See ASTM A153/A153M
Strip, plate, bars and rolled sections (not less than 3.18 mm thick)	ASTM A123/A123M	610 g/m <sup>2</sup>
Sheet (less than 3.18 mm thick)	ASTM A123/A123M	460 g/m <sup>2</sup> on material 0.76 mm thick <sup>(1)</sup>

**Notes to Table 9.20.16.1.:**

<sup>(1)</sup> ASTM A123/A123M does not apply to metal less than 0.76 mm thick. Galvanizing coatings may be interpolated for thicknesses between 3.18 mm and 0.76 mm.

## **9.20.17. Above-Ground Flat Insulating Concrete Form Walls**

### **9.20.17.1. Thickness of Flat Insulating Concrete Form Walls**

1) The thickness of the concrete in flat insulating concrete form walls not in contact with the ground shall be

- a) not less than 140 mm, and
- b) constant for the entire height of the wall.

### **9.20.17.2. Reinforcement for Flat Insulating Concrete Form Walls**

1) Horizontal reinforcement in above-grade flat insulating concrete form walls shall

- a) consist of
  - i) one 10M bar placed not more than 300 mm from the top of the wall, and
  - ii) 10M bars at 600 mm o.c., and
- b) be placed in the middle third of the wall section.

2) Vertical reinforcement in above-grade flat insulating concrete form walls shall

- a) consist of 10M bars at 400 mm o.c., and
- b) be placed in the middle third of the wall section.

3) Vertical reinforcement required by Sentence (2) and interrupted by wall openings shall be placed not more than 600 mm from each side of the opening.

### **9.20.17.3. Openings in Non-Loadbearing Flat Insulating Concrete Form Walls**

1) No openings shall occur within 1 200 mm of interior and exterior corners of exterior non-loadbearing flat insulating concrete form walls.

2) Portions of walls above openings in non-loadbearing flat insulating concrete form walls shall have a minimum depth of concrete of no less than 200 mm across the width of the opening.

3) Openings that are more than 600 mm but not more than 3 000 mm in width in non-loadbearing flat insulating concrete form walls shall be reinforced at the top and bottom with one 10M bar.

4) Openings more than 3 000 mm in width in non-loadbearing flat insulating concrete form walls shall be reinforced on all four sides with two 10M bars.

5) Reinforcing bars described in Sentences (3) and (4) shall extend 600 mm beyond the edges of the opening.

6) The cumulative width of openings in non-*loadbearing* flat insulating concrete form walls shall not make up more than 70% of the length of any wall.

**9.20.17.4. Openings in Loadbearing Flat Insulating Concrete Form Walls**

1) No openings shall occur within 1 200 mm of interior and exterior corners of exterior *loadbearing* flat insulating concrete form walls.

2) In *loadbearing* flat insulating concrete form walls, lintels shall be provided over all openings wider than 900 mm.

3) Lintels described in Sentence (2) shall be constructed in accordance with Span Table 9.20.17.4.-A, 9.20.17.4.-B or 9.20.17.4.-C.

4) Lintels described in Sentence (2) over openings wider than 1 200 mm shall be reinforced for shear with 10M stirrups at a maximum spacing of half the distance from the bottom reinforcing bar to the top of the lintel.

**9.20.17.5. Framing Supported on Flat Insulating Concrete Form Walls**

1) Floor joists supported on the side of flat insulating concrete form walls shall be supported with joist hangers secured to wood ledger boards.

2) The ledger boards referred to in Sentence (1) shall be not less than

- a) 38 mm thick, and
- b) the depth of the floor joists.

3) Anchor bolts shall be used to secure ledger boards to flat insulating concrete form walls and shall be

- a) embedded in the wall to a depth not less than 100 mm, and
- b) spaced in accordance with Table 9.20.17.5.

4) Floor joists and *building* frames supported on the top of flat insulating concrete form walls shall be anchored in conformance with Article 9.23.6.1.

**Table 9.20.17.5.**

**Maximum Anchor Bolt Spacing for the Connection of Floor Ledgers to Flat Insulating Concrete Form Walls**

**Forming Part of Sentence 9.20.17.5.(3)**

Maximum Clear Floor Span, m	Maximum Anchor Bolt Spacing, mm	
	Staggered 12.7 mm Diameter Anchor Bolts	Staggered 16 mm Diameter Anchor Bolts
2.44	450	500
3.0	400	450
4.0	300	400
5.0	275	325

**9.20.17.6. Anchoring of Roof Framing to the Top of Flat Insulating Concrete Form Walls**

1) Roof framing supported on the top of flat insulating concrete form walls shall be fixed to the top plates, which shall be anchored to the wall with anchor bolts

- a) not less than 12.7 mm in diameter, and

- b) spaced at not more than 1 200 mm o.c.
- 2) The anchor bolts described in Sentence (1) shall be placed in the centre of the flat insulating concrete form wall and shall be embedded no less than 100 mm into the concrete.
- 3) Attachment of roof framing to wood top plates shall be in accordance with Table 9.23.3.4.

#### **9.20.17.7. Protection from Precipitation and Damage**

- 1) Above-ground flat insulating concrete form walls shall be protected from precipitation and damage in conformance with Section 9.27.

## **Section 9.21. Masonry and Concrete Chimneys and Flues**

### **9.21.1. General**

#### **9.21.1.1. Application**

- 1) This Section applies to
  - a) rectangular *masonry or concrete chimneys* not more than 12 m in height serving fireplaces or serving *appliances* having a combined total rated heat output of 120 kW or less, and
  - b) *flue pipes* connected to such *chimneys*.
- 2) *Chimneys*, other than those described in Sentence (1), *gas vents* and *flue pipes* serving gas-, oil- or solid-fuel-burning *appliances* and their associated equipment, including *stoves, cooktops, ovens* and *space heaters*, covered by the standards referenced in Sentences 9.33.5.2.(1) and 9.33.5.3.(1) shall conform to Subsection 9.33.10.
- 3) *Chimneys* and *flue pipes* other than those described in Sentences (1) and (2) shall conform to Section 6.3.

#### **9.21.1.2. Chimney or Flue Pipe Walls**

- 1) The walls of any *chimney* or *flue pipe* shall be constructed so as to be smoke- and flame-tight.

### **9.21.2. Chimney Flues**

#### **9.21.2.1. Chimney Flue Limitations**

- 1) A *chimney flue* that serves a fireplace or incinerator shall not serve any other *appliance*.
- 2) A *chimney flue* that serves a solid-fuel-burning *appliance* shall not be connected to a natural-gas- or propane-fired *appliance*.
- 3) A *chimney flue* that serves a solid-fuel-burning *appliance* shall not be connected to an oil-burning *appliance* unless the solid-fuel-burning *appliance* is certified for such installation and the installation of both *appliances* meets the requirements of the relevant standards referenced in Article 9.33.5.2.

#### **9.21.2.2. Connections of More Than One Appliance**

- 1) Except as required by Article 9.21.2.1., where two or more fuel-burning *appliances* are connected to the same *chimney flue*, the connections shall be made as described in Sentences (2) to (4) and an adequate draft shall be provided for the connected *appliances* in conformance with the requirements of applicable provincial or territorial regulations or municipal bylaws or, in the absence of such regulations or bylaws, with the requirements of the relevant standards listed in Subsection 9.33.10.

- 2) Where 2 or more fuel-burning *appliances* are connected to the same *chimney flue*, the *appliances* shall be located on the same *storey*.
- 3) The connection referred to in Sentence (2) for a solid-fuel-burning *appliance* shall be made below connections for *appliances* burning other fuels.
- 4) The connection referred to in Sentence (2) for a liquid-fuel-burning *appliance* shall be made below any connections for *appliances* burning natural gas or propane.

**9.21.2.3. Inclined Chimney Flues**

- 1) *Chimney flues* shall not be inclined more than 45° to the vertical.

**9.21.2.4. Size of Chimney Flues**

- 1) Except for *chimneys* serving fireplaces, the size of a *chimney flue* shall conform to the requirements of the *appliance* installation standards referenced in Sentences 9.33.5.2.(1) and 9.33.5.3.(1).
- 2) Where a *chimney flue* serves only one *appliance*, the *flue* area shall be at least equal to that of the *flue pipe* connected to it.

**9.21.2.5. Fireplace Chimneys**

- 1) The size of a *chimney flue* serving a masonry fireplace shall conform to Table 9.21.2.5.-A or 9.21.2.5.-B.

**Table 9.21.2.5.-A  
Diameter of Round Flues for Fireplace Chimneys  
Forming Part of Sentence 9.21.2.5.(1)**

Fireplace Opening, m²	Chimney Height, m							
	3.0 to 4.5		>4.5 to 5.9		> 5.9 to 8.9		>8.9 to 12	
	Flue Diameter, mm							
	min.	max.	min.	max.	min.	max.	min.	max.
up to 0.150	110	170	100	160	90	150	90	150
0.151 to 0.250	150	210	130	190	130	190	120	180
0.251 to 0.350	180	240	160	220	150	210	140	200
0.351 to 0.500	220	280	200	260	190	250	170	230
0.501 to 0.650	260	320	230	290	220	280	200	260
0.651 to 0.800	290	350	260	320	240	300	220	280
0.801 to 1.00	330	390	290	350	270	330	250	310
1.01 to 1.20	360	420	320	380	300	360	270	330
1.21 to 1.40	390	450	350	410	330	390	300	360
1.41 to 1.60	420	480	380	440	350	410	320	380
1.61 to 1.80	—	—	400	460	370	430	340	400
1.81 to 2.00	—	—	—	—	400	460	360	420
2.01 to 2.20	—	—	—	—	—	—	380	440

**Table 9.21.2.5.-B**  
**Rectangular Flue Sizes for Fireplace Chimneys**  
**Forming Part of Sentence 9.21.2.5.(1)**

Fireplace Opening, m <sup>2</sup>	Chimney Height, m							
	3.0 to 4.5		>4.5 to 5.9		> 5.9 to 8.9		>8.9 to 12	
	Flue Size, mm							
	min.	max.	min.	max.	min.	max.	min.	max.
up to 0.150	200 × 200	200 × 200	100 × 200	100 × 200	100 × 200	100 × 200	100 × 200	100 × 200
0.151 to 0.250	200 × 200	200 × 200	200 × 200	200 × 200	200 × 200	200 × 200	200 × 200	200 × 200
0.251 to 0.350	200 × 300	200 × 300	200 × 200	200 × 300	200 × 200	200 × 200	200 × 200	200 × 200
0.351 to 0.500	300 × 300	300 × 300	200 × 300	200 × 300	200 × 300	200 × 300	200 × 200	200 × 300
0.501 to 0.650	300 × 300	300 × 400	300 × 300	300 × 300	300 × 300	300 × 300	200 × 300	200 × 300
0.651 to 0.800	300 × 400	300 × 400	300 × 300	300 × 400	300 × 300	300 × 300	300 × 300	300 × 300
0.801 to 1.00	400 × 400	400 × 400	300 × 400	300 × 400	300 × 400	300 × 400	300 × 300	300 × 300
1.01 to 1.20	400 × 400	400 × 400	400 × 400	400 × 400	300 × 400	300 × 400	300 × 400	300 × 400
1.21 to 1.40	—	—	400 × 400	400 × 400	400 × 400	400 × 400	300 × 400	300 × 400
1.41 to 1.60	—	—	—	—	400 × 400	400 × 400	400 × 400	400 × 400
1.61 to 1.80	—	—	—	—	—	—	400 × 400	400 × 400
1.81 to 2.00	—	—	—	—	—	—	400 × 400	400 × 400

**9.21.2.6. Oval Chimney Flues**

- 1) The width of an oval *chimney flue* shall be not less than two-thirds its breadth.

**9.21.3. Chimney Lining**

**9.21.3.1. Lining Materials**

- 1) Every *masonry or concrete chimney* shall have a lining of clay, concrete, firebrick or metal.

**9.21.3.2. Joints in Chimney Liners**

- 1) Joints of *chimney liners* shall be sealed to provide a barrier to the passage of *flue* gases and condensate into the cavity between the liner and the surrounding masonry.

- 2) Joints of clay, concrete or firebrick *chimney liners* shall be struck flush to provide a straight, smooth, aligned *chimney flue*.



### **9.21.3.3. Clay Liners**

- 1) Clay liners shall conform to CAN/CSA-A324-M, "Clay Flue Liners."
- 2) Liners referred to in Sentence (1) shall be not less than 15.9 mm thick and shall be capable of resisting, without softening or cracking, a temperature of 1 100°C.

### **9.21.3.4. Firebrick Liners**

- 1) Firebrick liners shall conform to ASTM C27, "Standard Classification of Fireclay and High-Alumina Refractory Brick."
- 2) Firebrick liners shall be laid with high temperature cement mortar conforming to CAN/CGSB-10.3, "Air Setting Refractory Mortar."

### **9.21.3.5. Concrete Liners**

- 1) Concrete *flue* liners shall conform to Clause 4.2.6.4 of CAN/CSA-A405-M, "Design and Construction of Masonry Chimneys and Fireplaces."

### **9.21.3.6. Metal Liners**

- 1) Metal liners shall be constructed of not less than 0.3 mm thick stainless steel.
- 2) Metal liners referred to in Sentence (1) shall only be used in *chimneys* serving gas- or oil-burning *appliances*. (See Note A-9.21.3.6.(2).)

### **9.21.3.7. Installation of Chimney Liners**

- 1) *Chimney liners* shall be installed when the surrounding masonry or concrete is placed.

### **9.21.3.8. Spaces between Liners and Surrounding Masonry**

- 1) A space not less than 10 mm wide shall be left between a *chimney liner* and surrounding masonry.
- 2) The space required in Sentence (1) shall not be filled with mortar.

### **9.21.3.9. Mortar for Chimney Liners**

- 1) *Chimney liners* used in *chimneys* for solid-fuel-burning *appliances* shall be laid in a full bed of
  - a) high temperature cement mortar conforming to CAN/CGSB-10.3, "Air Setting Refractory Mortar," or
  - b) mortar consisting of 1 part Portland cement to 3 parts sand by volume.
- 2) *Chimney liners* used in *chimneys* for oil- or gas-burning *appliances* shall be laid in a full bed of mortar consisting of 1 part Portland cement to 3 parts sand by volume.

### **9.21.3.10. Extension of Chimney Liners**

- 1) *Chimney liners* shall extend from a point not less than 200 mm below the lowest *flue pipe* connection to a point not less than 50 mm or more than 100 mm above the *chimney* cap.

## **9.21.4. Masonry and Concrete Chimney Construction**

### **9.21.4.1. Unit Masonry**

- 1) Unit masonry shall conform to Section 9.20.

### **9.21.4.2. Concrete**

- 1) Concrete shall conform to Section 9.3.

### **9.21.4.3. Footings**

1) Footings for *masonry chimneys* and *concrete chimneys* shall conform to Section 9.15.

#### **9.21.4.4. Height of Chimney Flues**

1) A *chimney flue* shall extend not less than

a) 900 mm above the highest point at which the *chimney* comes in contact with the roof, and

b) 600 mm above the highest roof surface or structure within 3 m of the *chimney*.

(See Note A-9.21.4.4.(1).)

#### **9.21.4.5. Lateral Stability**

1) Except as provided in Sentence (2), *chimneys* shall be braced in accordance with Subsection 4.3.2. to provide lateral stability under wind loads.

2) A *chimney* need not be laterally braced provided

a) no horizontal outside dimension is less than 400 mm, and

b) the *chimney* extends not more than 3.6 m above a roof or the masonry wall of which it forms a part.

(See Note A-9.21.4.5.(2).)

#### **9.21.4.6. Chimney Caps**

1) The top of a *chimney* shall have a waterproof cap of reinforced concrete, masonry or metal.

2) The cap required in Sentence (1) shall slope from the lining and be provided with a drip not less than 25 mm from the *chimney* wall.

3) Cast-in-place concrete caps shall be separated from the *chimney liner* by a bond break and be sealed at that location.

4) Jointed precast concrete or masonry *chimney* caps shall have flashing installed beneath the cap extending from the liner to the drip edge.

#### **9.21.4.7. Cleanout**

1) A cleanout opening with a metal frame and a tight-fitting metal door shall be installed near the base of the *chimney flue*.

#### **9.21.4.8. Wall Thickness**

1) The walls of a masonry *chimney* shall be built of *solid masonry units* not less than 75 mm thick.

#### **9.21.4.9. Separation of Flue Liners**

1) *Flue* liners in the same *chimney* shall be separated by not less than 75 mm of masonry or concrete exclusive of liners where clay liners are used, or 90 mm of firebrick where firebrick liners are used.

2) *Flue* liners referred to in Sentence (1) shall be installed to prevent significant lateral movement.

#### **9.21.4.10. Flashing**

1) Junctions with adjacent materials shall be adequately flashed to shed water.

### **9.21.5. Clearance from Combustible Construction**

#### **9.21.5.1. Clearance from Combustible Materials**

1) The clearance between *masonry or concrete chimneys* and *combustible* framing shall be not less than

a) 50 mm for interior *chimneys*, and

b) 12 mm for exterior *chimneys*.

(See Note A-9.21.5.1.(1).)

2) A clearance of not less than 150 mm shall be provided between a cleanout opening and *combustible* material.

3) *Combustible* flooring and subflooring shall have not less than a 12 mm clearance from *masonry or concrete chimneys*.

#### **9.21.5.2. Sealing of Spaces**

1) All spaces between *masonry or concrete chimneys* and *combustible* framing shall be sealed top or bottom with *noncombustible* material.

#### **9.21.5.3. Support of Joists or Beams**

1) Joists or beams may be supported on masonry walls which enclose *chimney flues* provided the *combustible* members are separated from the *flue* by not less than 290 mm of *solid masonry*.

## **Section 9.22. Fireplaces**

### **9.22.1. General**

#### **9.22.1.1. Application**

1) Except when otherwise specifically stated herein, this Section applies to masonry fireplaces constructed on-site.

#### **9.22.1.2. Masonry and Concrete**

1) Except as otherwise stated in this Section, unit masonry shall conform to Section 9.20. and concrete to Section 9.3.

2) Masonry above openings shall be supported by steel lintels conforming to Sentence 9.20.5.2.(2), reinforced concrete or a masonry arch.

#### **9.22.1.3. Footings**

1) Footings for masonry and concrete fireplaces shall conform to Section 9.15.

#### **9.22.1.4. Combustion Air**

1) Where a supply of combustion air is provided directly to the fire chamber of a fireplace, including a factory-built fireplace, the installation shall comply with the "Outdoor Air Supply" requirements provided in CAN/CSA-A405-M, "Design and Construction of Masonry Chimneys and Fireplaces."

### **9.22.2. Fireplace Liners**

#### **9.22.2.1. Brick or Steel Liners**

1) Except where a fireplace is equipped with a steel liner, every fireplace shall have a firebrick liner.

#### **9.22.2.2. Firebrick Liners**

1) Firebrick liners shall be not less than

a) 50 mm thick for the sides and back, and

- b) 25 mm thick for the floor.
- 2) Firebrick liners shall be laid with high temperature cement mortar conforming to CAN/CGSB-10.3, "Air Setting Refractory Mortar."
- 3) Joints between a firebrick liner and the adjacent backing masonry shall be offset.

### **9.22.2.3. Steel Liners**

1) Steel liners for fireplaces shall conform to CAN/ULC-S639-M, "Standard for Steel Liner Assemblies for Solid-Fuel Burning Masonry Fireplaces," and shall be installed in accordance with the installation instructions in that standard.

## **9.22.3. Fireplace Walls**

### **9.22.3.1. Thickness of Walls**

1) Except as provided in Sentence (2), the thickness of the back and sides of a fireplace, including the thickness of any firebrick liner, shall be not less than 190 mm where a metal liner or a firebrick liner less than 51 mm thick is used.

2) When a steel fireplace liner is used with an air circulating chamber surrounding the firebox, the back and sides of the fireplace shall consist of

- a) *solid masonry units* not less than 90 mm thick, or
- b) hollow masonry units not less than 190 mm thick.

## **9.22.4. Fire Chamber**

### **9.22.4.1. Fire Chamber Dimensions**

1) The distance from the back of the fire chamber to the plane of the fireplace opening shall be not less than 300 mm.

## **9.22.5. Hearth**

### **9.22.5.1. Hearth Extension**

1) Except as required in Sentence (2), fireplaces shall have a *noncombustible* hearth extending not less than 400 mm in front of the fireplace opening and not less than 200 mm beyond each side of the fireplace opening.

2) Where the fire chamber floor is elevated more than 150 mm above the hearth, the dimension of the hearth measured perpendicular to the plane of the fireplace opening shall be increased by not less than

- a) 50 mm for an elevation above 150 mm and not more than 300 mm, and
- b) an additional 25 mm for every 50 mm in elevation above 300 mm.

### **9.22.5.2. Support of Hearth**

1) Except as permitted in Sentence (2), the fire chamber floor and hearth shall be supported on a reinforced concrete slab not less than 100 mm thick at its supports and, if cantilevered, not less than 50 mm thick at its unsupported edge.

2) A hearth for a fireplace with an opening raised not less than 200 mm from a *combustible* floor is permitted to be supported on that floor provided the requirements of Clauses 5.3.6.5. to 5.3.6.7. of CAN/CSA-A405-M, "Design and Construction of Masonry Chimneys and Fireplaces," are followed.

## **9.22.6. Damper**

#### **9.22.6.1. Required Damper and Size**

1) The throat of every fireplace shall be equipped with a metal damper sufficiently large to cover the full area of the throat opening.

#### **9.22.7. Smoke Chamber**

##### **9.22.7.1. Slope of Smoke Chamber**

1) The sides of the smoke chamber connecting a fireplace throat with a *flue* shall not be sloped at an angle greater than 45° to the vertical.

##### **9.22.7.2. Wall Thickness**

1) The thickness of masonry walls surrounding the smoke chamber shall be not less than 190 mm at the sides, front and back, except that the portions of the back exposed to the outside may be 140 mm thick.

#### **9.22.8. Factory-Built Fireplaces**

##### **9.22.8.1. Conformance to Standard**

1) Factory-built fireplaces and their installation shall conform to CAN/ULC-S610, "Standard for Factory-Built Fireplace Systems."

#### **9.22.9. Clearance of Combustible Material**

##### **9.22.9.1. Clearance to the Fireplace Opening**

1) *Combustible* material shall not be placed on or near the face of a fireplace within 150 mm of the fireplace opening, except that where the *combustible* material projects more than 38 mm out from the face of the fireplace above the opening, such material shall be not less than 300 mm above the top of the opening.

##### **9.22.9.2. Metal Exposed to the Interior**

1) Metal exposed to the interior of a fireplace such as the damper control mechanism shall have not less than a 50 mm clearance from any *combustible* material on the face of the fireplace where such metal penetrates through the face of the fireplace.

##### **9.22.9.3. Clearance to Combustible Framing**

1) Not less than a 100 mm clearance shall be provided between the back and sides of a fireplace and *combustible* framing, except that a 50 mm clearance is permitted where the fireplace is located in an exterior wall.

2) Not less than a 50 mm clearance shall be provided between the back and sides of the smoke chamber of a fireplace and *combustible* framing, except that a 25 mm clearance is permitted where the fireplace is located in an exterior wall.

##### **9.22.9.4. Heat-Circulating Duct Outlets**

1) The clearance of *combustible* material above heat-circulating duct outlets from those outlets shall be not less than

- a) 300 mm where the *combustible* material projects not less than 38 mm from the face, and
- b) 150 mm where the projection is less than 38 mm.

#### **9.22.10. Fireplace Inserts and Hearth-Mounted Stoves**

##### **9.22.10.1. Appliance Standard**

1) Fireplace inserts and hearth-mounted *stoves* vented through the throat of a fireplace shall conform to ULC-S628, "Standard for Fireplace Inserts."

#### **9.22.10.2. Installation**

1) The installation of fireplace inserts and hearth-mounted *stoves* vented through the throat of a fireplace shall conform to CSA B365, "Installation Code for Solid-Fuel-Burning Appliances and Equipment."

## **Section 9.23. Wood-Frame Construction**

### **9.23.1. Application**

#### **9.23.1.1. Limitations**

(See Note A-9.23.1.1.)

1) Subject to the application limitations defined elsewhere in this Part, this Section applies to constructions where wall, floor and roof planes are generally comprised of lumber frames of small repetitive structural members, or engineered components, and where

- a) roof and wall planes are clad, sheathed or braced on at least one side,
- b) the small repetitive structural members are spaced not more than 600 mm o.c.,
- c) the constructions do not serve as *foundations*,
- d) the specified *live load* on supported subfloors and floor framing does not exceed 2.4 kPa, and
- e) the span of any structural member does not exceed 12.20 m.

(See Note A-9.23.1.1.(1).)

2) Where the conditions in Sentence (1) are exceeded for wood constructions, the design of the framing and fastening shall conform to Subsection 4.3.1.

### **9.23.2. General**

#### **9.23.2.1. Strength and Rigidity**

1) All members shall be so framed, anchored, fastened, tied and braced to provide the necessary strength and rigidity.

#### **9.23.2.2. Protection from Decay**

1) Ends of wood joists, beams and other members framing into masonry or concrete shall be treated to prevent decay where the bottom of the member is at or below ground level, or a 12 mm air space shall be provided at the end and sides of the member.

2) Air spaces required in Sentence (1) shall not be blocked by insulation, *vapour barriers* or airtight materials.

#### **9.23.2.3. Protection from Dampness**

1) Except as permitted in Sentence (2), wood framing members that are not pressure-treated with a wood preservative and that are supported on concrete in contact with the ground or *fill* shall be separated from the concrete by not less than 0.05 mm polyethylene film or Type S roll roofing.

2) Dampproofing material referred to in Sentence (1) is not required where the wood member is at least 150 mm above the ground.

**9.23.2.4. Connections to Preservative-Treated Wood**

1) Except as provided in Sentence (3), connectors in contact with preservative-treated wood shall be made of

a) hot-dipped, zinc-coated galvanized steel with a coating weight not less than Z550 conforming to ASTM A653/A653M, "Standard Specification for Steel Sheet, Zinc-Coated (Galvanized) or Zinc-Iron Alloy-Coated (Galvannealed) by the Hot-Dip Process,"

b) a material that provides an equivalent level of corrosion protection to that provided by the material described in Clause (a), or

c) stainless steel.

2) Fasteners used to attach the connectors referred to in Sentence (1) shall be made of

a) galvanized steel coated with zinc in accordance with ASTM A153/A153M, "Standard Specification for Zinc Coating (Hot-Dip) on Iron and Steel Hardware," or

b) a material that provides an equivalent level of performance and is compatible with the connector.

3) Connectors and fasteners that are in contact with wood that has been treated with a disodium octaborate tetrahydrate (SBX (DOT)) or zinc borate preservative and is installed in a dry interior environment are permitted to be made of uncoated carbon steel. (See Note A-9.23.2.4.(3).)

**9.23.2.5. Lumber**

1) Lumber shall conform to Subsection 9.3.2.

**9.23.3. Fasteners and Connectors**

**9.23.3.1. Standards for Nails and Screws**

1) Except as provided in Sentence (2) and unless otherwise indicated, nails specified in this Section shall be common steel wire nails or common spiral nails conforming to

a) ASTM F1667, "Standard Specification for Driven Fasteners: Nails, Spikes, and Staples," or

b) CSA B111, "Wire Nails, Spikes and Staples."

2) Nails used to comply with Table 9.23.3.4. and 9.23.3.5.-A to 9.23.3.5.-C shall have a diameter not less than that stated in Table 9.23.3.1. (See Note A-9.23.3.1.(2).)

**Table 9.23.3.1.**

**Diameter of Nails**

**Forming Part of Sentence 9.23.3.1.(2)**

Minimum Length of Nails, mm	Minimum Diameter of Nails, mm
45	2.64
51	2.84
57	2.87
63	3.25
76	3.66
82	3.66
101 or greater	4.88

3) Wood screws specified in this Section shall conform to ASME B18.6.1, “Wood Screws (Inch Series).” (See Note A-9.23.3.1.(3).)

**9.23.3.2. Length of Nails**

1) All nails shall be long enough so that not less than half their required length penetrates into the second member.

**9.23.3.3. Prevention of Splitting**

1) Splitting of wood members shall be minimized by staggering the nails in the direction of the grain and by keeping nails well in from the edges. (See Note A-9.23.3.3.(1).)

**9.23.3.4. Nailing of Framing**

1) Except as provided in Sentence (2), nailing of framing shall conform to Table 9.23.3.4.

2) Where the bottom wall plate or sole plate of an exterior wall is not nailed to floor joists, *rim joists* or blocking in conformance with Table 9.23.3.4., the exterior wall is permitted to be fastened to the floor framing by

a) having plywood, OSB or waferboard sheathing extend down over floor framing and fastened to the floor framing by nails or staples conforming to Article 9.23.3.5., or

b) tying the wall framing to the floor framing by galvanized-metal strips

i) 50 mm wide,

ii) not less than 0.41 mm thick,

iii) spaced not more than 1.2 m apart, and

iv) fastened at each end with at least two 63 mm nails.

**Table 9.23.3.4.**

**Nailing for Framing**

**Forming Part of Sentences 9.23.3.4.(1) and 9.23.14.4.(2)**

Construction Detail	Minimum Length of Nails, mm	Minimum Number or Maximum Spacing of Nails <sup>(1)</sup>
Floor joist or blocking perpendicular to sill plate or top wall plate below – toe nail	82	2 per floor joist or blocking
<i>Rim joist</i> , trimmer joist or blocking – supporting walls with required <i>braced wall panels</i> – to sill plate or top wall plate – toe nail	82	150 mm o.c.
Wood or metal strapping to underside of floor joists	57	2
Cross bridging to joists	57	2 at each end
Double header or trimmer joists	76	300 mm o.c.
Floor joist to stud (balloon construction)	76	2
Ledger strip to wood beam	82	2 per joist
Joist to joist splice (see also Table 9.23.14.8.)	76	2 at each end
Tail joist to adjacent header joist	82	5
(end nailed) around openings	101	3
Each header joist to adjacent trimmer joist	82	5
(end nailed) around openings	101	3
Blocking to stud or stud to wall plate (each end) toe nail	63	4



or end nail	82	2
Doubled studs at openings, or studs at walls or wall intersections and corners	76	750 mm o.c.
Doubled studs at openings, within walls, or abutting studs at wall intersections and corners – in required <i>braced wall panels</i>	76	300 mm o.c.
Doubled top wall plates <sup>(1)</sup>	76	600 mm o.c.
Bottom wall plate or sole plate to floor joists, <i>rim joists</i> or blocking (exterior walls) <sup>(2)</sup>	82	400 mm o.c.
Bottom wall plate or sole plate – in required <i>braced wall panels</i> – to floor joists, <i>rim joists</i> or blocking (exterior walls) <sup>(2)</sup>	82	150 mm o.c.
Interior walls to framing or subflooring	82	600 mm o.c.
Required <i>braced wall panels</i> – in interior walls – to framing above and below	82	150 mm o.c.
Horizontal member over openings in non- <i>loadbearing</i> walls – each end	82	2
Lintels to studs	82	2 at each end
Ceiling joist to plate – toe nail each end	82	2
Roof rafter, roof truss or roof joist to plate – toe nail <sup>(3)</sup>	82	3
Rafter plate to each ceiling joist	101	2
Rafter to joist (with ridge supported)	76	3
Rafter to joist (with ridge unsupported)	76	see Table 9.23.14.8.
Gusset plate to each rafter at peak	57	4
Rafter to ridge board – toe nail – end nail	82	3
Collar tie to rafter – each end	76	3
Collar tie lateral support to each collar tie	57	2
Jack rafter to hip or valley rafter	82	2
Roof strut to rafter	76	3
Roof strut to <i>loadbearing</i> wall – toe nail	82	2
38 mm × 140 mm or less plank decking to support	82	2
Plank decking wider than 38 mm × 140 mm to support	82	3
38 mm edge laid plank decking to support (toe nail)	76	1
38 mm edge laid plank to each other	76	450 mm o.c.
End-joist or end-rafter to built-up wall stud <sup>(4)</sup>	76	5 or 8 <sup>(5)</sup>

**Notes to Table 9.23.3.4.:**

<sup>(1)</sup> See Note A-9.23.3.1.(2).

<sup>(2)</sup> See Article 9.23.11.4. for requirements on the nailing of top plates splices in *braced wall bands*.

<sup>(3)</sup> See Sentence 9.23.3.4.(2).

<sup>(4)</sup> See Sentence 9.23.3.4.(3).

<sup>(5)</sup> Where heavyweight construction is used in the roof of the space, at least 8 nails are required (see Note A-9.23.13.2.(3)).

3) Where the 1-in-50-year hourly wind pressure is equal to or greater than 0.8 kPa, roof rafters, joists or trusses shall be tied to the wall framing with connectors that will resist a factored uplift load of 3 kN.

4) Galvanized-steel straps are deemed to comply with Sentence (3), provided they are

a) 50 mm wide,

b) not less than 0.91 mm thick, and

c) fastened at each end with at least four 63 mm nails.

**9.23.3.5. Fasteners for Sheathing or Subflooring**

1) Fastening of the following shall conform to Table 9.23.3.5.-A:

a) subflooring,

b) wall sheathing not in a required *braced wall panel*, and

c) roof sheathing where the 1-in-50-year hourly wind pressure (HWP) is not greater than 0.6 kPa and the seismic design parameter,  $S_{max}$ , for Site Class C is not greater than 0.47.

**Table 9.23.3.5.-A**

**Fastening of Subflooring, Wall Sheathing Not in a Required Braced Wall Panel, and Roof Sheathing Where  $HWP \leq 0.6$  kPa and  $S_{max}$  for Site Class C  $\leq 0.47$**

**Forming Part of Sentence 9.23.3.5.(1)**

Element	Minimum Length of Fasteners, mm				Minimum Number or Maximum Spacing of Fasteners <sup>(1)</sup>
	Common or Spiral Nails	Ring Thread Nails or Screws	Roofing Nails	Staples	
Board lumber 184 mm or less wide	51	45	n/a	51	2 per support
Board lumber more than 184 mm wide	51	45	n/a	51	3 per support
Fibreboard sheathing up to 13 mm thick	n/a	n/a	44	28	150 mm o.c. along edges and 300 mm o.c. along intermediate supports
Gypsum sheathing up to 13 mm thick	n/a	n/a	44	n/a	
Plywood, OSB or waferboard up to 10 mm thick	51	45	n/a	38	
Plywood, OSB or waferboard over 10 mm and up to 20 mm thick	51	45	n/a	51	
Plywood, OSB or waferboard over 20 mm and up to 25 mm thick	57	51	n/a	n/a	

**Note to Table 9.23.3.5.-A:**

<sup>(1)</sup> See Note A-9.23.3.1.(2).

2) Except as provided in Sentence (4), fastening of roof sheathing shall conform to Table 9.23.3.5.-B, where

a) the 1-in-50-year hourly wind pressure (HWP) is greater than 0.6 kPa but not greater than 1.2 kPa, or

b) the seismic design parameter,  $S_{max}$ , for Site Class C is greater than 0.47 but  $S_{max}$  is not greater than 2.6.

**Table 9.23.3.5.-B**

**Fastening of Roof Sheathing Where  $0.6$  kPa  $< HWP \leq 1.2$  kPa or Where  $S_{max}$  for Site Class C  $> 0.47$  and  $S_{max} \leq 2.6$**

**Forming Part of Sentence 9.23.3.5.(2)**

Element	Minimum Length of Fasteners, mm
---------	---------------------------------

HWP and $S_{max}^{(1)}$ Limits		Common, Spiral or Ring Thread Nails	Screws	14-Gauge Staples	Minimum Number or Maximum Spacing of Fasteners <sup>(2)</sup>
0.6 kPa < HWP ≤ 0.8 kPa and $S_{max} ≤ 0.6$ or $S_{max}$ for Site Class C > 0.47, $S_{max} ≤ 0.6$ and HWP ≤ 0.8 kPa	Board lumber 184 mm or less wide <sup>(3)</sup>	63	51	63	2 per support
	Board lumber more than 184 mm wide <sup>(3)</sup>	63	51	63	3 per support
	Plywood, OSB or waferboard up to 20 mm thick	63	51	63	150 mm o.c. along the edges of sheathing panels and 300 mm o.c. along intermediate supports
	Plywood, OSB or waferboard over 20 mm and up to 25 mm thick	63	57	n/a	
0.8 kPa < HWP ≤ 1.2 kPa and $S_{max} ≤ 2.6$ or $S_{max}$ for Site Class C > 0.47, 0.6 < $S_{max} ≤ 2.6$ and HWP ≤ 1.2 kPa	Plywood, OSB or waferboard up to 20 mm thick	63	51	n/a	75 mm o.c. along the edges of sheathing panels, 300 mm o.c. along intermediate supports, and where 0.8 kPa < HWP ≤ 1.2 kPa, 50 mm o.c. within 1 m of the edges of the roof
	Plywood, OSB or waferboard over 20 mm and up to 25 mm thick	63	57	n/a	

**Notes to Table 9.23.3.5.-B:**

<sup>(1)</sup> See Article 9.4.2.5.

<sup>(2)</sup> See Note A-9.23.3.1.(2).

<sup>(3)</sup> See Article 9.23.16.5.

3) Except as provided in Sentence (4), fastening of wall sheathing in required *braced wall panels* shall conform to the reference framing types specified in Table 9.23.3.5.-C.

**Table 9.23.3.5.-C**

**Fastening of Wall Sheathing in Required Braced Wall Panels Where HWP ≤ 1.2kPa and  $S_{max} ≤ 2.6$**

**Forming Part of Sentence 9.23.3.5.(3)**

Reference framing type <sup>(1)</sup>	Minimum Sheathing Element <sup>(2)</sup> and Maximum Stud Spacing	Minimum Specifications for Fasteners		Minimum Number or Maximum Spacing of Fasteners <sup>(3)(4)</sup> along Panel Edges Fastened to Framing
		Common, Spiral or Ring Thread Nails	Screws	
GWB-O (interior side of WSP and DWB framing types)	12.5 mm gypsum board for 600 mm stud spacing	2.48 mm diameter ring thread	3.45 mm shank diameter,	200 mm o.c. for nails or 300 mm o.c. for screws
GWB-A	12.5 mm gypsum board for 600 mm stud spacing			200 mm o.c. for nails or 300 mm o.c. for screws

GWB-B	12.5 mm gypsum board for 400 mm stud spacing	with 20 mm penetration into support framing <sup>(5)</sup>	Type W, with 20 mm penetration into support framing <sup>(6)</sup>	200 mm o.c.
GWB-C	12.5 mm gypsum board for 400 mm stud spacing or 12.5 mm gypsum board, blocked, <sup>(7)</sup> for 600 mm stud spacing			150 mm o.c. or 200 mm o.c. for blocked
GWB-D	12.5 mm gypsum board for 400 mm stud spacing			100 mm o.c.
WSP-A	9.5 mm plywood, OSB or waferboard for 400 mm stud spacing	2.84 mm x 51 mm <sup>(8)</sup>	NP <sup>(8)</sup>	150 mm o.c.
WSP-B	11 mm plywood, OSB or waferboard, blocked, <sup>(7)</sup> for 600 mm stud spacing	3.25 mm x 63 mm <sup>(8)</sup>		150 mm o.c.
WSP-C	11 mm plywood, OSB or waferboard, blocked, <sup>(7)</sup> for 600 mm stud spacing	3.25 mm x 63 mm <sup>(8)</sup>		100 mm o.c.
WSP-D	11 mm plywood, OSB or waferboard, blocked, <sup>(7)</sup> for 600 mm stud spacing	3.25 mm x 63 mm <sup>(8)</sup>		75 mm o.c.
WSP-E	15.5 mm plywood, OSB or waferboard, blocked, <sup>(7)</sup> for 600 mm stud spacing	3.66 mm x 76 mm <sup>(8)</sup>		75 mm o.c.
DWB	19 mm diagonal lumber board	3.25 mm x 63 mm <sup>(8)</sup>	3.25 mm x 51 mm	2 per support framing where lumber width ≤ 184 mm or 3 per support framing where lumber width > 184 mm

**Notes to Table 9.23.3.5.-C:**

<sup>(1)</sup> See Note A-Table 9.23.3.5.-C.

<sup>(2)</sup> Plywood, OSB, waferboard and board lumber shall conform to the material standards specified in Subsection 9.23.17. Wood-based panels may be installed vertically or horizontally. Gypsum sheathing shall conform to the requirements of gypsum board in Subsection 9.29.5.

<sup>(3)</sup> See Note A-9.23.3.1.(2).

<sup>(4)</sup> For plywood, OSB, or waferboard panel sheathing, the maximum fastener spacing along intermediate supports shall be 300 mm o.c. For gypsum sheathing, the maximum spacing along intermediate supports shall conform to Sentence 9.29.5.8.(4) for nails and Sentence 9.29.5.9.(4) for screws.

<sup>(5)</sup> Nails for GWB framing types shall conform to Article 9.29.5.6.

<sup>(6)</sup> Screws for GWB framing types shall conform to Article 9.29.5.7.

<sup>(7)</sup> Where blocking is required, horizontal joints of panel sheathing shall occur over blocking consisting of not less than 38 mm x 89 mm lumber oriented either edgewise or flatwise, and the panel sheathing shall be fastened to the blocking.

<sup>(8)</sup> Nails for WSP and DWB framing types shall conform to Article 9.23.3.1.

<sup>(9)</sup> NP = Not permitted

4) Fastening of wall sheathing in required *braced wall panels* and roof sheathing shall conform to Part 4, where

- a) the 1-in-50-year hourly wind pressure (HWP) is greater than 1.2 kPa,
- b) the seismic design parameter,  $S_{max}$ , is greater than 2.6, or
- c) the seismic design parameter,  $S_{max}$ , for Site Class C is greater than 0.47, for *buildings* of 3 storeys in building height and
  - i) of heavy weight construction,
  - ii) clad at full height with masonry veneer, or
  - iii) clad at full height with stone veneer.

(See Sentence 9.23.13.2.(3).)

- 5) Staples shall not be less than 1.6 mm in diameter or thickness, with not less than a 9.5 mm crown driven with the crown parallel to framing.
- 6) Roofing nails for the attachment of fibreboard or gypsum sheathing shall not be less than 3.2 mm in diameter with a minimum head diameter of 11.1 mm.
- 7) Flooring screws shall not be less than 3.2 mm in diameter.

**9.23.4. Maximum Spans**

**9.23.4.1. Application**

- 1) Spans provided in this Subsection for joists, beams and lintels supporting floors shall apply only where
  - a) the floors serve residential areas as described in Table 4.1.5.3., or
  - b) the uniformly distributed *live load* on the floors does not exceed that specified for residential areas as described in Table 4.1.5.3.
- 2) Spans for joists, beams and lintels supporting floors shall be determined according to Subsection 4.1.3. where the supported floors
  - a) serve other than residential areas, or
  - b) support a uniform *live load* in excess of that specified for residential areas.

**9.23.4.2. Spans for Joists, Rafters and Beams**

(See Note A-9.23.4.2.)

- 1) Except as required in Sentence (2) and Article 9.23.14.10., spans for wood joists and rafters shall conform to the spans shown in Span Tables 9.23.4.2.-A to 9.23.4.2.-G for the uniform *live loads* shown in the Tables. (See Article 9.4.2.2.)
- 2) Spans for floor joists that are not selected from Span Tables 9.23.4.2.-A and 9.23.4.2.-B and that are required to be designed for the same loading conditions, shall not exceed the design requirements for uniform loading and vibration criteria. (See Note A-9.23.4.2.(2).)
- 3) Spans for built-up wood and glued-laminated timber floor beams shall conform to the spans in Span Tables 9.23.4.2.-H to 9.23.4.2.-K. (See Article 9.4.2.2.)
- 4) Spans for roof ridge beams shall conform to the spans in Span Table 9.23.4.2.-L for the uniform snow load shown. (See Articles 9.4.2.2. and 9.23.14.8.)

**9.23.4.3. Steel Beams**

- 1) The spans for steel floor beams with laterally supported top flanges shall conform to Table 9.23.4.3. (See Note A-9.23.4.3.(1).)
- 2) Beams described in Sentence (1) shall at least meet the requirements for Grade 350 W steel contained in CSA G40.21, "Structural quality steel."

**Table 9.23.4.3.**

**Maximum Spans for Steel Beams Supporting Floors in Dwelling Units(1)**

**Forming Part of Sentence 9.23.4.3.(1)**

Section	Supported Joist Length, m (half the sum of joist spans on both sides of the beam)						
	2.4	3.0	3.6	4.2	4.8	5.4	6.0
One Storey Supported							

W150 × 22	5.5	5.2	4.9	4.8	4.6	4.5	4.3
W200 × 21	6.5	6.2	5.9	5.7	5.4	5.1	4.9
W200 × 27	7.3	6.9	6.6	6.3	6.1	5.9	5.8
W200 × 31	7.8	7.4	7.1	6.8	6.6	6.4	6.2
W250 × 24	8.1	7.6	7.3	7.0	6.6	6.2	5.9
W250 × 33	9.2	8.7	8.3	8.0	7.7	7.5	7.3
W250 × 39	10.0	9.4	9.0	8.6	8.4	8.1	7.9
W310 × 31	10.4	9.8	9.4	8.9	8.4	8.0	7.6
W310 × 39	11.4	10.7	10.2	9.8	9.5	9.2	9.0
Two Storeys Supported							
W150 × 22	4.9	4.4	4.1	3.8	3.5	3.4	3.2
W200 × 21	5.6	5.1	4.6	4.3	4.1	3.8	3.7
W200 × 27	6.4	6.1	5.6	5.3	4.9	4.7	4.4
W200 × 31	6.9	6.5	6.2	5.8	5.4	5.1	4.9
W250 × 24	6.8	6.1	5.6	5.2	4.9	4.6	4.4
W250 × 33	8.2	7.7	7.0	6.5	6.1	5.8	5.5
W250 × 39	8.8	8.3	7.8	7.2	6.8	6.4	6.1
W310 × 31	8.7	7.8	7.2	6.7	6.2	5.9	5.6
W310 × 39	10.0	9.3	8.5	7.9	7.4	7.0	6.7

Notes to Table 9.23.4.3.:

(<sup>o</sup>) See Note A-Table 9.23.4.3.

#### 9.23.4.4. Concrete Topping

(See Note A-9.23.4.4.)

1) Except as permitted in Sentence (2), where a floor is required to support a concrete topping, the joist spans shown in Span Table 9.23.4.2.-A or the spacing of the members shall be reduced to allow for the loads due to the topping.

2) Where a floor is required to support a concrete topping, joist spans are permitted to be selected from Span Table 9.23.4.2.-B provided the concrete

- a) is 38 to 51 mm thick,
- b) is normal weight,
- c) is placed directly on the subflooring, and
- d) has not less than 20 MPa compressive strength after 28 days.

3) Where a floor is required to support a concrete topping not more than 51 mm thick, the allowable beam spans shown in Span Tables 9.23.4.2.-H to 9.23.4.2.-K shall be multiplied by 0.8 or the supported length of the floor joists shall be reduced to allow for the loads due to the topping.

#### 9.23.4.5. Heavy Roofing Materials

1) Where a roof is required to support an additional uniform *dead load* from roofing materials such as concrete roofing tile, or materials other than as specified in Section 9.26., such as clay roofing tiles, the additional load shall be allowed for by reducing

a) the spans for roof joists and rafters in Span Tables 9.23.4.2.-D to 9.23.4.2.-G, or the spacing of the members, and

b) the spans for ridge beams and lintels in Span Tables 9.23.4.2.-L and 9.23.12.3.-A to 9.23.12.3.-D.

(See Note A-9.23.4.2.)

## **9.23.5. Notching and Drilling**

### **9.23.5.1. Holes Drilled in Framing Members**

1) Holes drilled in roof, floor or ceiling framing members shall be not larger than one-quarter the depth of the member and shall be located not less than 50 mm from the edges, unless the depth of the member is increased by the size of the hole.

### **9.23.5.2. Notching of Framing Members**

1) Floor, roof and ceiling framing members are permitted to be notched provided the notch is located on the top of the member within half the joist depth from the edge of bearing and is not deeper than one-third the joist depth, unless the depth of the member is increased by the size of the notch.

### **9.23.5.3. Wall Studs**

1) Wall studs shall not be notched, drilled or otherwise damaged so that the undamaged portion of the stud is less than two-thirds the depth of the stud if the stud is *loadbearing* or 40 mm if the stud is *non-loadbearing*, unless the weakened studs are suitably reinforced.

### **9.23.5.4. Top Plates**

1) Top plates in walls shall not be notched, drilled or otherwise weakened to reduce the undamaged width to less than 50 mm unless the weakened plates are suitably reinforced.

### **9.23.5.5. Roof Trusses**

1) Roof truss members shall not be notched, drilled or otherwise weakened unless such notching or drilling is allowed for in the design of the truss.

## **9.23.6. Anchorage**

### **9.23.6.1. Anchorage of Building Frames**

1) Except as required by Sentence 9.23.6.3.(1), *building* frames shall be anchored to the *foundation* unless a structural analysis that considers wind and earthquake loads and lateral earth pressures shows that anchorage is not required.

2) Except as provided in Sentences (3) to (6), anchorage shall be provided by

a) embedding the ends of the first floor joists in concrete, or

b) fastening the sill plate to the *foundation* with not less than 12.7 mm diam anchor bolts spaced not more than 2.4 m o.c.

3) Except as provided in Sentence (6), where the seismic design parameter,  $S_{max}$ , for Site Class C is greater than 0.47, anchorage of *braced wall panel* shall be provided by fastening the sill plate to the *foundation* with anchor bolts, such that

- a) there are not less than two anchor bolts per *braced wall panel*, located at opposite ends of the *braced wall panel* within 0.5 m of the *foundation* end or within 0.3 m of the end of the *braced wall panel*, and
- b) anchor bolts spaced in accordance with Table 9.23.6.1. (See Note A-9.23.6.1.(3).)

**Table 9.23.6.1.-A**

**Anchor Bolt Spacing within Braced Wall Panels Where HWP ≤ 1.2 kPa, S<sub>max</sub> for Site Class C > 0.47 and S<sub>max</sub> ≤ 2.6**

**Forming Part of Sentence 9.23.6.1.(3)**

Reference Framing Type	Maximum Spacing of Anchor Bolts within <i>Braced Wall Panels</i> , m	
	Anchor Bolt Diameter	
	12.7 mm	15.9 mm
GWB-A	2.4	2.4
GWB-B	2.4	2.4
GWB-C	1.8	2.4
GWB-D	1.4	2.1
WSP-A	1.4	2.1
WSP-B	0.8	1.2
WSP-C	0.7	1.0
WSP-D	0.6	0.9
WSP-E	0.5	0.8
DWB	0.8	1.2

- 5) Anchor bolts referred to in Sentences (2) and (3) shall be
  - a) fastened to the sill plate with nuts and washers,
  - b) embedded not less than 100 mm in the *foundation*, and
  - c) so designed that they may be tightened without withdrawing them from the *foundation*.
- 6) Anchorage shall be designed according to Part 4, where
  - a) the 1-in-50-year hourly wind pressure (HWP) is greater than 1.2 kPa,
  - b) the seismic design parameter, S<sub>max</sub>, is greater than 2.6, or
  - c) the seismic design parameter, S<sub>max</sub>, for Site Class C is greater than 0.47, for *buildings* of 3 *storeys* in *building height* and
    - i) of heavy weight construction,
    - ii) clad at full height with masonry veneer, or
    - iii) clad at full height with some stone veneer.

(See Sentence 9.23.13.2.(3).)

**9.23.6.2. Anchorage of Columns and Posts**

- 1) Except as provided in Sentences (2) and (3), exterior columns and posts shall be anchored to resist uplift and lateral movement.



2) Except as provided in Sentence (3), where columns or posts support balconies, decks, verandas or other exterior platforms, and the distance from finished ground to the underside of the joists is not more than 600 mm,

a) the columns or posts shall be anchored to the *foundation* to resist uplift and lateral movement, or

b) the supported joists or beams shall be directly anchored to the ground to resist uplift.

3) Anchorage is not required for platforms described in Sentence (2) that

a) are not more than 1 *storey* in height,

b) are not more than 55 m<sup>2</sup> in area,

c) do not support a roof, and

d) are not attached to another structure, unless it can be demonstrated that differential movement will not adversely affect the performance of the structure to which the platform is attached.

### **9.23.6.3. Anchorage of Smaller Buildings**

1) *Buildings* not more than 4.3 m wide and not more than 1 *storey* in *building height* that are not anchored in accordance with Sentence 9.23.6.1.(1) shall be anchored in conformance with the requirements of CSA Z240.10.1, "Site preparation, foundation, and installation of buildings."

### **9.23.7. Sill Plates**

#### **9.23.7.1. Size of Sill Plates**

1) Where sill plates provide bearing for the floor system, they shall be not less than 38 mm by 89 mm material.

#### **9.23.7.2. Levelling and Sealing of Sill Plates**

1) Sill plates shall be

a) levelled by setting them on a full bed of mortar, or

b) laid directly on the *foundation* if the top of the *foundation* is level.

(See also Article 9.23.2.3.)

2) The joint between the sill plate for exterior walls and the *foundation* shall be sealed in accordance with Subsection 9.25.3.

### **9.23.8. Beams to Support Floors**

#### **9.23.8.1. Bearing for Beams**

1) Beams shall have even and level bearing and the bearing at end supports shall be not less than 89 mm long, except as stated in the notes to Span Tables 9.23.4.2.-H to 9.23.4.2.-K.

#### **9.23.8.2. Priming of Steel Beams**

1) Exterior steel beams shall be shop primed.

#### **9.23.8.3. Built-up Wood Beams**

(See Note A-9.23.8.3.)

1) Where a beam is made up of individual pieces of lumber that are nailed together, the individual members shall be 38 mm or greater in thickness and installed on edge.

- 2) Except as permitted in Sentence (3), where individual members of a built-up beam are butted together to form a joint, the joint shall occur over a support.
- 3) Where a beam is continuous over more than one span, individual members are permitted to be butted together to form a joint at or within 150 mm of the end quarter points of the clear spans, provided the quarter points are not those closest to the ends of the beam.
- 4) Members joined at quarter points shall be continuous over adjacent supports.
- 5) Joints in individual members of a beam that are located at or near the end quarter points shall not occur in adjacent members at the same quarter point and shall not reduce the effective beam width by more than half.
- 6) Not more than one butt joint shall occur in any individual member of a built-up beam within any one span.
- 7) Except as provided in Sentence (8), where 38 mm members are laid on edge to form a built-up beam, individual members shall be nailed together with a double row of nails not less than 89 mm in length, spaced not more than 450 mm apart in each row with the end nails located 100 mm to 150 mm from the end of each piece.
- 8) Where 38 mm members in built-up wood beams are not nailed together as provided in Sentence (7), they shall be bolted together with not less than 12.7 mm diam bolts equipped with washers and spaced not more than 1.2 m o.c., with the end bolts located not more than 600 mm from the ends of the members.

### **9.23.9. Floor Joists**

#### **9.23.9.1. End Bearing for Joists**

- 1) Except when supported on ribbon boards, floor joists shall have not less than 38 mm length of end bearing.
- 2) Ribbon boards referred to in Sentence (1) shall be not less than 19 mm by 89 mm lumber let into the studs.

#### **9.23.9.2. Joists Supported by Beams**

- 1) Floor joists may be supported on the tops of beams or may be framed into the sides of beams.
- 2) When framed into the side of a wood beam, joists referred to in Sentence (1) shall be supported on
  - a) joist hangers or other acceptable mechanical connectors, or
  - b) not less than 38 mm by 64 mm ledger strips nailed to the side of the beam, except that 38 mm by 38 mm ledger strips may be used provided each joist is nailed to the beam by not less than four 89 mm nails, in addition to the nailing for the ledger strip required in Table 9.23.3.4.
- 3) When framed into the side of a steel beam, joists referred to in Sentence (1) shall be supported on the bottom flange of the beam or on not less than 38 mm by 38 mm lumber bolted to the web with not less than 6.3 mm diam bolts spaced not more than 600 mm apart.
- 4) Joists referred to in Sentence (3) shall be spliced above the beam with not less than 38 mm by 38 mm lumber at least 600 mm long to support the flooring.
- 5) Not less than a 12 mm space shall be provided between the splice required in Sentence (4) and the beam to allow for shrinkage of the wood joists.

#### **9.23.9.3. Restraint of Joist Bottoms**

1) Except as provided in Sentence 9.23.9.4.(1), bottoms of floor joists shall be restrained from twisting at each end by toe-nailing to the supports, end-nailing to the header joists or by providing continuous strapping, blocking between the joists or cross-bridging near the supports.

#### **9.23.9.4. Strapping, Bridging, Furring and Ceilings in Span Tables 9.23.4.2.-A and -B**

(See Note A-9.23.4.2.(2).)

1) Except as permitted by Sentence (5), where strapping is specified in Span Table 9.23.4.2.-A, it shall be

- a) not less than 19 mm by 64 mm, nailed to the underside of floor joists,
- b) located not more than 2 100 mm from each support or other rows of strapping, and
- c) fastened at each end to a sill or header.

2) Where bridging is specified in Span Table 9.23.4.2.-A, it shall consist of not less than 19 mm by 64 mm or 38 mm by 38 mm cross bridging located not more than 2 100 mm from each support or other rows of bridging.

3) Where bridging and strapping are specified in Span Table 9.23.4.2.-A,

a) bridging shall

i) comply with Sentence (2), or

ii) consist of 38 mm solid blocking located not more than 2 100 mm from each support or other rows of bridging and securely fastened between the joists, and

b) except as provided in Sentence (5), strapping shall comply with Sentence (1) and be installed under the bridging.

4) Bridging specified in Span Table 9.23.4.2.-B shall consist of

a) bridging as described in Sentence (2), or

b) 38 mm solid blocking located not more than 2 100 mm from each support or other rows of bridging and securely fastened between the joists.

5) Strapping described in Sentence (1) and Clause (3)(b) is not required where

a) furring strips complying with Table 9.29.3.1. are fastened directly to the joists, or

b) a panel-type ceiling finish complying with Subsection 9.29.5., 9.29.6., 9.29.7., 9.29.8., or 9.29.9. is attached directly to the joists.

6) Where a ceiling attached to wood furring is specified in Span Table 9.23.4.2.-B,

a) the ceiling finish shall consist of gypsum board, plywood or OSB not less than 12.7 mm thick, and

b) the furring shall be

i) 19 mm by 89 mm wood furring spaced at not more than 600 mm o.c., or

ii) 19 mm by 64 mm wood furring spaced at not more than 400 mm o.c.

#### **9.23.9.5. Header Joists**

1) Header joists around floor openings shall be doubled when they exceed 1.2 m in length.

2) The size of header joists exceeding 3.2 m in length shall be determined by calculations.

#### **9.23.9.6. Trimmer Joists**

- 1) Trimmer joists around floor openings shall be doubled when the length of the header joist exceeds 800 mm.
- 2) When the header joist exceeds 2 m in length the size of the trimmer joists shall be determined by calculations.

#### **9.23.9.7. Support of Tail and Header Joists**

- 1) When tail joists and header joists are supported by the floor framing, they shall be supported by suitable joist hangers or nailing in accordance with Table 9.23.3.4.

#### **9.23.9.8. Support of Walls**

- 1) Non-*loadbearing* walls parallel to the floor joists shall be supported by joists beneath the wall or on blocking between the joists.
- 2) Blocking referred to in Sentence (1) for the support of non-*loadbearing* walls shall be
  - a) not less than 38 mm by 89 mm lumber, and
  - b) except as required for the fastening of walls constructed with required *braced wall panels*, spaced not more than 1.2 m apart.
- 3) Except as provided in Sentence (6), non-*loadbearing* interior walls at right angles to the floor joists are not restricted as to location.
- 4) *Loadbearing* interior walls parallel to floor joists shall be supported by beams or walls of sufficient strength to safely transfer the specified *live loads* to the vertical supports.
- 5) Unless the joist size is designed to support such loads, *loadbearing* interior walls at right angles to floor joists shall be located
  - a) not more than 900 mm from the joist support where the wall does not support a floor, and
  - b) not more than 600 mm from the joist support where the wall supports one or more floors.
- 6) *Loadbearing* and non-*loadbearing* walls constructed with required *braced wall panels* shall be continuously supported by floor joists, blocking or *rim joists* to allow for the required fastening (see Table 9.23.3.4.).

#### **9.23.9.9. Cantilevered Floor Joists**

- 1) Floor joists supporting roof loads shall not be cantilevered more than 400 mm beyond their supports where 38 mm by 184 mm joists are used and not more than 600 mm beyond their supports where 38 mm by 235 mm or larger joists are used.
- 2) The cantilevered portions referred to in Sentence (1) shall not support floor loads from other *storeys* unless calculations are provided to show that the design resistances of the cantilevered joists are not exceeded.
- 3) Where cantilevered floor joists described in Sentences (1) and (2) are at right angles to the main floor joists, the tail joists in the cantilevered portion shall extend inward away from the cantilever support a distance equal to not less than 6 times the length of the cantilever, and shall be end nailed to an interior doubled header joist in conformance with Table 9.23.3.4.

#### **9.23.10. Wall Studs**

##### **9.23.10.1. Stud Size and Spacing**

- 1) The size and spacing of studs shall conform to Table 9.23.10.1.

**Table 9.23.10.1.**  
**Size and Spacing of Studs**  
**Forming Part of Sentence 9.23.10.1.(1)**

Type of Wall	Supported Loads (including <i>dead loads</i> )	Minimum Stud Size, mm	Maximum Stud Spacing, mm	Maximum Unsupported Height, m
Interior	No load	38 × 38	400	2.4
		38 × 89 flat <sup>(1)</sup>	400	3.6
	Attic not accessible by a stairway	38 × 64	600	3.0
		38 × 64 flat <sup>(1)</sup>	400	2.4
		38 × 89	600	3.6
		38 × 89 flat <sup>(1)</sup>	400	2.4
		Attic accessible by a stairway plus one floor Roof load plus one floor Attic not accessible by stairway plus 2 floors	38 × 89	400
	Roof load Attic accessible by a stairway Attic not accessible by a stairway plus one floor	38 × 64	400	2.4
		38 × 89	600	3.6
	Attic accessible by a stairway plus 2 floors Roof load plus 2 floors	38 × 89	300	3.6
		64 × 89	400	3.6
		38 × 140	400	4.2
	Attic accessible by a stairway plus 3 floors Roof load plus 3 floors	38 × 140	300	4.2
Exterior	Roof with or without attic storage	38 × 64	400	2.4
		38 × 89	600	3.0
	Roof with or without attic storage plus one floor	38 × 89	400	3.0
		38 × 140	600	3.0
	Roof with or without attic storage plus 2 floors	38 × 89	300	3.0
		64 × 89	400	3.0
		38 × 140	400	3.6
	Roof with or without attic storage plus 3 floors	38 × 140	300	1.8

Notes to Table 9.23.10.1.:

<sup>(1)</sup> See Article 9.23.10.3.

### 9.23.10.2. Bracing and Lateral Support

1) Where *loadbearing* interior walls are not finished in accordance with Section 9.29., blocking or strapping shall be fastened to the studs at mid-height to prevent sideways buckling.

### 9.23.10.3. Orientation of Studs

1) Except as permitted in Sentences (2) and (3), all studs shall be placed at right angles to the wall face.

2) Studs on the flat are permitted to be used in gable ends of roofs that contain only unfinished space or in non-*loadbearing* interior walls within the limits described in Article 9.23.10.1.

3) Wall studs that support only a load from an attic not accessible by a stairway are permitted to be placed on the flat within the limits permitted in Article 9.23.10.1. provided

a) the studs are clad on not less than one side with plywood, OSB or waferboard sheathing fastened to the face of the studs with a structural adhesive, and

b) the portion of the roof supported by the studs does not exceed 2.1 m in width.

#### **9.23.10.4. Continuity of Studs**

1) Wall studs shall be continuous for the full *storey* height except at openings and shall not be spliced except by fingerjoining with a structural adhesive. (See Note A-9.23.10.4.(1).)

#### **9.23.10.5. Support for Cladding, Sheathing and Finishing Materials**

1) Corners and intersections shall be designed to provide adequate support for the vertical edges of interior finishes, sheathing and cladding materials, and in no instance shall exterior corners be framed with less than the equivalent of 2 studs.

2) Where the vertical edges of interior finishes at wall intersections are supported at vertical intervals by blocking or furring, the vertical distance between such supports shall not exceed the maximum distance between supports specified in Section 9.29.

#### **9.23.10.6. Studs at Sides of Openings**

1) Where the lintel spanning the opening is more than 3 m long, studs shall be tripled on each side of the opening so that

a) the two inner studs on each side extend from the bottom of the supported lintel to the top of the bottom wall plate, and

b) the outer stud on each side extends from the bottom of the top wall plate to the bottom wall plate.

2) Except as provided in Sentence (3), where the lintel spanning the opening is not more than 3 m long, studs shall be doubled on each side of the opening so that

a) the inner studs on each side extend from the bottom of the supported lintel to the top of the bottom wall plate, and

b) the outer stud on each side extends from the bottom of the top wall plate to the bottom wall plate.

3) Single studs are permitted to be used on either side of openings

a) in non-*loadbearing* interior walls not required to have *fire-resistance ratings*, provided the studs extend from the top wall plate to the bottom wall plate, or

b) in *loadbearing* or non-*loadbearing* interior or exterior walls, provided

i) the opening is less than and within the required stud spacing, and

ii) no 2 such openings of full stud-space width are located in adjacent stud spaces.

(See Note A-9.23.10.6.(3).)

## **9.23.11. Wall Plates**

### **9.23.11.1. Size of Wall Plates**

- 1) Except as provided in Sentence (2), wall plates shall be
  - a) not less than 38 mm thick, and
  - b) not less than the required width of the wall studs.
- 2) In non-*loadbearing* walls and in *loadbearing* walls where the studs are located directly over framing members, the bottom wall plate is permitted to be 19 mm thick.

### **9.23.11.2. Bottom Wall Plates**

- 1) A bottom wall plate shall be provided in all cases.
- 2) The bottom plate in exterior walls shall not project more than one-third the plate width over the support.

### **9.23.11.3. Top Plates**

- 1) Except as permitted in Sentences (2) to (4), at least 2 top plates shall be provided in *loadbearing* walls.
- 2) A single top plate is permitted to be used in a section of a *loadbearing* wall containing a lintel provided the top plate forms a tie across the lintel.
- 3) A single top plate is permitted to be used in *loadbearing* walls where the concentrated loads from ceilings, floors and roofs are not more than 50 mm to one side of the supporting studs and in all non-*loadbearing* walls.
- 4) The top plates need not be provided in a section of *loadbearing* wall containing a lintel provided the lintel is tied to the adjacent wall section with not less than
  - a) 75 mm by 150 mm by 0.91 mm thick galvanized steel, or
  - b) 19 mm by 89 mm by 300 mm wood splice nailed to each wall section with at least three 63 mm nails.

### **9.23.11.4. Joints in Top Plates**

- 1) Joints in the top plates of *loadbearing* walls shall be staggered not less than
  - a) one stud spacing where the number of nails required by Sentence (5) is not more than 16,
  - b) two stud spacings where the number of nails required by Sentence (5) is greater than 16 and not more than 32, and
  - c) three stud spacings where the number of nails required by Sentence (5) is greater than 32.
- 2) The top plates in *loadbearing* walls shall be lapped or otherwise tied at corners and intersecting walls in accordance with Sentence (4).
- 3) Joints in single top plates used with *loadbearing* walls shall be tied in accordance with Sentence (4).
- 4) Ties referred to in Sentences (2) and (3) shall be the equivalent of not less than 75 mm by 150 mm by 0.91 mm thick galvanized steel nailed to each wall with at least three 63 mm nails.
- 5) Except as provided in Sentence (7), doubled top plates in *braced wall bands* shall be fastened on each side of a splice with not less than 76 mm long common steel wire nails or spiral nails in accordance with the minimum number of nails required by Table 9.23.11.4.-A or 9.23.11.4.-C, whichever is greater, where

a) the seismic design parameter,  $S_{max}$ , for Site Class C is greater than 0.47 and  $S_{max}$  is not greater than 2.6, or

b) the 1-in-50-year hourly wind pressure (HWP) is equal to or greater than 0.6 kPa but not greater than 1.2 kPa.

**Table 9.23.11.4.-A**

**Fasteners in Doubled Top Plate Splice Connections in Braced Wall Bands where  $S_{max}$  for Site Class C > 0.47 and  $S_{max} \leq 2.6^{(1)}$**

**Forming Part of Sentence 9.23.11.4.(5)**

$S_{max}^{(1)}$	Minimum Number of Nails on Each Side of Doubled Top Plate Splice for <i>Braced Wall Band</i> Spacing of 10.6 m <sup>(2)</sup>			
	Weight of Construction or Cladding Type <sup>(3)</sup>			
	Normal-Weight Construction	Heavyweight construction <sup>(4)</sup>	Masonry Veneer (on one or more <i>building faces</i> ) <sup>(4)(5)</sup>	Stone Veneer (on one or more <i>building faces</i> ) <sup>(4)(5)</sup>
$S_{max} \leq 0.60$	4	7	8	10
$0.6 < S_{max} \leq 0.8$	6	8	9	12
$0.8 < S_{max} \leq 1.2$	9	12	14	19
$1.2 < S_{max} \leq 1.6$	12	16	19	25
$1.6 < S_{max} \leq 2.0$	14	20	23	31
$2.0 < S_{max} \leq 2.6$	19	25	30	40

**Notes to Table 9.23.11.4.-A:**

<sup>(1)</sup> See Article 9.4.2.5.

<sup>(2)</sup> For *braced wall band* spacing of 7.6 m or less, the minimum number of fasteners is permitted to be divided by 2.

<sup>(3)</sup> See Sentence 9.23.13.2.(3).

<sup>(4)</sup> Limited to 2 *storeys* in *building height*. See Sentence (7).

<sup>(5)</sup> Where the height of the masonry or stone veneer does not exceed half *storey* above the *foundation*, the veneer may be disregarded.

**Table 9.23.11.4.-C**

**Fasteners in Doubled Top Plate Splice Connections in Braced Wall Bands Where 0.6 kPa < HWP ≤ 1.2 kPa**

**Forming Part of Sentence 9.23.11.4.(5)**

HWP	Minimum Number of Nails on Each Side of Doubled Top Plate Splice for <i>Braced Wall Band</i> Spacing of 10.6 m <sup>(1)</sup>
	Rough Terrain <sup>(2)</sup> , and Roof Eave-to-Ridge Height of 3 m <sup>(3)</sup>
HWP ≤ 0.3	7
0.3 < HWP ≤ 0.4	9
0.4 < HWP ≤ 0.5	11
0.5 < HWP ≤ 0.6	13
0.6 < HWP ≤ 0.9	20
0.9 < HWP ≤ 1.2	26



**Notes to Table 9.23.11.4.-C:**

<sup>(1)</sup> For a *braced wall band* spacing of 7.6 m or less, the minimum number of nails may be divided by 2.

<sup>(2)</sup> For open terrain, multiply the minimum number of nails by the wind exposure adjustment factor,  $K_{exp}$ , as provided in Table 9.23.13.7.-B. see Note A-9.23.13.7.(3) and (4)

<sup>(3)</sup> For roof-level top plates (i.e. top plates supporting roof framing), multiply the minimum number of nails by the roof eave-to-ridge height adjustment factor,  $K_{roof}$ , as provided in Table 9.23.13.7-B.

6) Nails referred to in Sentence (5) shall be spaced not less than 75 mm o.c. along the top plate in rows spaced not less than 35 mm apart.

7) Doubled top plates in *braced wall bands* shall be designed according to Part 4 where

a) the 1-in-50-year hourly wind pressure (HWP) is greater than 1.2 kPa,

b) the seismic design parameter,  $S_{max}$ , is greater than 2.6, or

c) the seismic design parameter,  $S_{max}$ , is greater than 0.47 for Site Class C for *buildings* of 3 storeys in *building height* and

i) of heavy weight construction,

ii) clad with masonry veneer, or

iii) clad with stone veneer.

(see Sentence 9.23.13.2.(3)).

## **9.23.12. Framing over Openings**

### **9.23.12.1. Openings in Non-Loadbearing Walls**

1) Except as provided in Sentence (2), openings in non-*loadbearing* walls shall be framed with not less than 38 mm material the same width as the studs, securely nailed to adjacent studs.

2) Openings for doors in non-*loadbearing* walls required to be *fire separations* with a *fire-resistance rating* shall be framed with the equivalent of at least two 38 mm thick members that are the same width as the wall plates.

### **9.23.12.2. Openings in Loadbearing Walls**

1) Openings in *loadbearing* walls greater than the required stud spacing shall be framed with lintels designed to carry the superimposed loads to adjacent studs. (See Note A-9.23.10.6.(3).)

2) Except as provided in Sentence 9.23.12.3.(2), where 2 or more members are used in lintels, they shall be fastened together with not less than 82 mm nails in a double row, with nails not more than 450 mm apart in each row.

3) Lintel members are permitted to be separated by filler pieces.

### **9.23.12.3. Lintel Spans and Sizes**

1) Spans and sizes of wood lintels shall conform to the spans shown in Span Tables 9.23.4.2.-L and 9.23.12.3.-A to 9.23.12.3.-D

a) for *buildings of residential occupancy*,

b) where the wall studs exceed 38 mm by 64 mm in size,

c) where the spans of supported joists do not exceed 4.9 m, and

d) where the spans of trusses do not exceed 9.8 m.

- 2) In *loadbearing* exterior and interior walls of 38 mm by 64 mm framing members, lintels shall consist of
- a) 64 mm thick members on edge, or
  - b) 38 mm thick and 19 mm thick members fastened together with a double row of nails not less than 63 mm long and spaced not more than 450 mm apart.
- 3) Lintels referred to in Sentence (2)
- a) shall be not less than 50 mm greater in depth than those shown in Span Tables 9.23.4.2.-L and 9.23.12.3.-A to 9.23.12.3.-D for the maximum spans shown, and
  - b) shall not exceed 2.24 m in length.

### **9.23.13. Bracing to Resist Lateral Loads Due to Wind and Earthquake**

(See Note A-9.23.13.)

#### **9.23.13.1. Requirements for Low to Moderate Wind and Seismic Forces**

- 1) This Article applies where
- a) the seismic design parameter,  $S_{max}$ , for Site Class C, is not more than 0.47,
  - b) the 1-in-50-year hourly wind pressure (HWP) is not greater than 0.60 kPa,
  - c) the unsupported height of the *braced wall panels* in the *building* is not greater than 3.1 m, and
  - d) the lowest exterior frame wall supports a roof and not more than 2 floors.
- 2) Bracing to resist lateral loads shall be designed and constructed in accordance with
- a) the simplified approach outlined in Article 9.23.13.11., where the seismic design parameter,  $S_{max}$ , is not greater than 0.47 and the 1-in-50-year hourly wind pressure (HWP) is not greater than 0.60 kPa,
  - b) Articles 9.23.13.4. to 9.23.13.10.,
  - c) Part 4, or
  - d) good engineering practice such as that provided in CWC “Engineering Guide for Wood Frame Construction.”

#### **9.23.13.2. Requirements for High Wind and Seismic Forces**

- 1) Except as provided in Article 9.23.13.1., this Article applies where
- a) the unsupported height of the *braced wall panels* in the *building* is not greater than 3.1 m,
  - b) 1-in-50-year hourly wind pressure (HWP) is not greater than 1.2 kPa,
  - c) the seismic design parameter,  $S_{max}$ , is not greater than 2.6, and
  - d) the lowest exterior frame wall supports a roof and not more than
    - i) 2 floors in a *building* of normal-weight construction, or
    - ii) 1 floor in a *building* of heavyweight construction or clad at full height with masonry veneer or stone veneer.
- 2) Bracing to resist lateral loads shall be designed and constructed in accordance with
- a) Articles 9.23.13.4. to 9.23.13.10.,
  - b) Part 4, or

c) good engineering practice such as that provided in CWC “Engineering Guide for Wood Frame Construction.”

3) For the purposes of Sentence (1) and this Part,

a) in a *building* of normal-weight construction, the average dead weight per storey shall not exceed

i) 0.5 kPa for floors and 0.5 kPa for *partitions* and interior walls,

ii) 0.5 kPa for the roof, and

iii) 0.4 kPa for exterior walls,

b) in a building of heavyweight construction, the average dead weight per *storey* shall conform to Clause (a), except that the average dead weight per *storey* shall not exceed

i) 1.5 kPa for floors and 0.5 kPa for *partitions* and interior walls,

ii) 1.0 kPa for the roof, or

iii) 1.2 kPa for exterior walls,

c) in a *building* clad with masonry veneer, the average dead weight of the masonry veneer shall not exceed 1.9 kPa, and

d) in a *building* clad with stone veneer, the average dead weight of the stone veneer shall not exceed 3.2 kPa. (See Note A-9.23.13.2.(3).)

#### **9.23.13.3. Requirements for Extreme Wind and Seismic Forces**

1) Except as provided in Articles 9.23.13.1. and 9.23.13.2., this Article applies where

a) the 1-in-50-year hourly wind pressure (HWP) is greater than 1.2 kPa,

b) the seismic design parameter,  $S_{max}$ , is greater than 2.6, or

d) the seismic design parameter,  $S_{max}$ , for Site Class C is greater than 0.47, and the lowest exterior frame wall supports a roof and more than 1

floor in a *building* of heavyweight construction or clad at full height with masonry veneer or stone veneer.

2) Bracing to resist lateral loads shall be designed and constructed in accordance with

a) Part 4, or

b) good engineering practice such as that provided in the CWC “Engineering Guide for Wood Frame Construction.”

#### **9.23.13.4. Braced Wall Bands**

(See Note A-9.23.13.4.)

1) *Braced wall bands* shall

a) surround the perimeter of the *building*,

b) be full *storey* height,

c) be not more than 1.2 m wide,

d) lap at both ends with another *braced wall band*,

e) be aligned with *braced wall bands* on *storeys* above and below, and

- f) conform to the spacing and dimensions given in Table 9.23.13.5. and Article 9.23.13.7.
- 2) For split-level *buildings*, a *braced wall band* shall be located where there is a change in floor level greater than the depth of one floor joist.

**9.23.13.5. Braced Wall Panels in Braced Wall Bands**

- 1) Except as provided in Sentences (2) and 9.23.13.10.(2) to (4) and Article 9.23.13.7., *braced wall panels* shall
- a) be located within *braced wall bands*,
  - b) be laterally supported at each floor level and the roof,
  - c) extend, as applicable, from the top of the supporting footing, slab or subfloor to the underside of the floor, ceiling or roof framing above, and
  - d) conform to the spacing and dimensions given in Table 9.23.13.5. and Article 9.23.13.7.

**Table 9.23.13.5.**

**Spacing and Dimensions of Braced Wall Bands and Braced Wall Panels  
Forming Part of Sentences 9.23.13.4.(1) and 9.23.13.5.(1)**

Description	Spacing and Dimensions of <i>Braced Wall Bands</i> and <i>Braced Wall Panels</i> <sup>(1)(2)(3)</sup>
Maximum distance between centre lines of adjacent <i>braced wall bands</i> measured from the furthest points between centres of the bands <sup>(4)</sup>	10.6 m
Maximum distance between required <i>braced wall panels</i> measured from the edges of the panels	6.4 m
Maximum distance from the end of a <i>braced wall band</i> to the edge of the closest required <i>braced wall panel</i>	2.4 m
Minimum length of individual wood-sheated <i>braced wall panels</i> :	
• panel located at the end of a <i>braced wall band</i> where the <i>braced wall panel</i> connects to an intersecting <i>braced wall panel</i>	600 mm
• panel not located at the end of a <i>braced wall band</i> or <i>braced wall panel</i> located at the end of a <i>braced wall band</i> where the <i>braced wall panel</i> does not connect to an intersecting <i>braced wall panel</i>	750 mm
Minimum length of individual <i>braced wall panels</i> sheated only with gypsum board	1.2 m
Minimum length of individual diagonal-lumber-sheated <i>braced wall panels</i>	1.2 m
Minimu total length of all <i>braced wall panels</i> in a <i>braced wall band</i>	Per Article 9.23.13.7.

**Notes to Table 9.23.13.5.:**

- <sup>(1)</sup> See Note A-Table 9.23.13.5.
- <sup>(2)</sup> All constructions include support of a roof load in addition to the indicated number of floors.
- <sup>(3)</sup> See Article 9.23.13.10. for additional system considerations.
- <sup>(4)</sup> See Sentence (2) for an exception for *basements* and crawl spaces.

2) In *basements* or crawl spaces where the perimeter *foundation* walls extend from the footings to the underside of the supported floor, *braced wall bands* constructed with *braced wall panels* shall

a) have a total length of braced wall panels not less than the total length in the *braced wall band* in the storey above, and

b) be spaced not more than

i) 15 m from the perimeter *foundation walls*,

ii) 15 m from interior *foundation walls*, and

iii) 15 m from adjacent *braced wall bands* constructed with *braced wall panels*.

(See Note A-9.23.13.5.(2).)

3) Interior or exterior wood-sheathed *braced wall panels*, other than panels of WSP-A framing in the uppermost storey shall

a) extend to the roof framing, and

b) have their the top plate connected to

i) top chords of perpendicular or offset parallel trusses by using blocking panels or other methods of lateral load transfer designed by the roof truss manufacturer,

ii) perpendicular or offset parallel joists or rafters by using blocking of the same construction as the *braced wall panel* below, or

iii) rafters, joists or trusses by using methods of lateral load transfer designed in accordance with good engineering practice.

(See Note A-9.23.13.5.(3) and (4).)

4) The top plates of braced wall panels described in Sentence (3) shall be fastened in accordance with Table 9.23.3.4.

(See Note A-9.23.13.5.(3) and (4).)

### **9.23.13.6. Materials in Braced Wall Panels**

1) Required *braced wall panels* shall be

a) sheathed on the exterior side with plywood, OSB, waferboard or diagonal lumber complying with Subsection 9.23.17. fastened in accordance with Sentence 9.23.3.5.(3) and finished on the interior side with gypsum board complying with Subsection 9.29.5., or

b) sheathed on the interior side or exterior side with gypsum board complying with Subsection 9.29.5. and fastened in accordance with Sentence 9.23.3.5.(3). (See Note A-9.23.13.6.(1).)

2) Except as provided in Sentences (4) and (5), *braced wall bands* shall be constructed of *braced wall panels* of the same sheathing material.

3) *Braced wall panels* in *basements* and crawl spaces shall be sheathed with OSB, plywood, waferboard or diagonal lumber

a) at *braced wall band* spacing intervals of not more than 15 m, and

b) under all interior *braced wall bands* containing wood-sheathed *braced wall panels*. (See Note A-9.23.13.6.(3).)

4) Mixing of *braced wall panel* framing types is permitted in stacked *braced wall bands*, provided that wood-sheathed *braced wall panels* are not above any *braced wall bands* containing

a) gypsum-sheathed *braced wall panels*, or

b) diagonal-lumber-sheathed *braced wall panels*.

5) Mixing of *braced wall panel* framing types is permitted along a *braced wall band* within the same storey, provided that

a) panels of WSP-A or WSP-B framing type are substituted for panels of a GWB framing type and the total length of all of the *braced wall panels* is determined based on the GWB framing type, or

b) the lengths of the *braced wall panels* of mixed framing types are based on accepted engineering principles.

(See Note A-9.23.13.6.(5).)

### 9.23.13.7. Braced Wall Panel Length

1) Except as provided in Tables 9.23.13.7.-B and 9.23.13.7.-D, all adjustment factors required for the calculation of the minimum total length of *braced wall panels* in accordance with this Article shall be taken as 1.

2) The minimum total length of all *braced wall panels* in a *braced wall band* shall be taken as the greater of  $L_w$  determined in Sentence (3) for the appropriate 1-in-50-year hourly wind pressure (HWP) and  $L_s$  as determined in Sentence (4) for the appropriate seismic design parameter,  $S_{max}$ , where

a) HWP is not greater than 1.2 kPa, and

b)  $S_{max}$  for Site Class C, is not greater than 2.6.

3) For resistance to wind pressure, the minimum total length of *braced wall panels* in each *braced wall band*,  $L_w$ , shall be determined by applying the adjustment factors provided in Table 9.23.13.7.-B to the unadjusted minimum total *braced wall panel* length  $L_{uw}$  provided in Table 9.23.13.7.-A using the following equation:

$$L_w = L_{uw}K_{exp}K_{roof}K_{Wspacing}K_{Wnumber}K_{gyp}K_{sheath} \geq BWP_{min}$$

where

$K_{exp}$  = wind exposure adjustment factor, and

= 1 for rough terrain (suburban, urban or wooded terrain extending upwind from the *building* uninterrupted for at least 1 km),  $K_{roof}$  = roof eave-to-ridge height adjustment factor, and  
= 1 for a roof eave-to-ridge height of 3 m

$K_{Wspacing}$  = *braced wall band* spacing adjustment factor for wind (see Sentence (5)), per *building* plan direction, and

= 1 for a *braced wall band* spacing of 7.6 m

$K_{Wnumber}$  = number of parallel *braced wall bands* adjustment factor for wind, per *building* plan direction, and

= 1 for two exterior walls and no intermediate *braced wall bands*,

$K_{gyp}$  = interior gypsum board adjustment factor, and

= 1 for *braced wall panels* with gypsum board installed on the interior side,


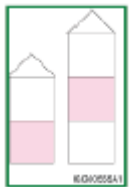
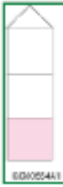

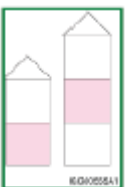
$K_{sheath}$  = intermittent *braced wall panels* adjustment factor, and

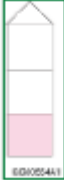

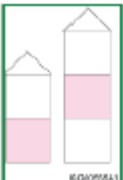


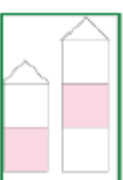


= 1 for continuously sheathed *braced wall bands*, and

$BWP_{min}$  = Minimum length of individual *braced wall panels* as per Table 9.23.13.5.

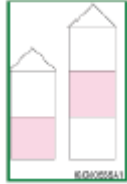
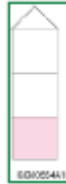

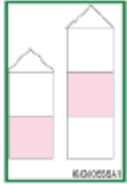

(See Note A-9.23.13.7.(3) for an alternative procedure to calculate  $L_w$ , directly and Note A-9.23.13.7.(4).)

**Table 9.23.13.7.-A**  
**Unadjusted Minimum Total Braced Wall Panel Lengths for Wind**  
**Forming Part of Sentence 9.23.13.7.(3)**

		Unadjusted Minimum Total <i>Braced Wall Panel</i> Length for Wind, $L_{uw}$ , m <sup>(1)</sup>									
		Diagonal-Lumber-Sheathed Framing Type (with gypsum board on opposite side) <sup>(2)</sup>	Gypsum-Sheathed Framing Type (with gypsum board on only one side) <sup>(2)(3)</sup>				Wood-sheathed Framing Type (with gypsum board on opposite side) <sup>(2)</sup>				
HWP	Storey	DWB	GWB-A	GWB-B	GWB-C	GWB-D	WSP-A	WSP-B	WSP-C	WSP-D	WSP-E
HWP ≤ 0.3		0.65	3.29	1.91	1.42	1.14	1.14	0.60	0.52	0.48	0.43
		1.33	6.75	3.92	2.91	2.35	2.35	1.24	1.08	0.98	0.88
		2.02	10.21	5.93	4.40	3.57	3.57	1.87	1.63	1.49	1.34
0.3 < HWP ≤ 0.4		0.86	4.38	2.54	1.89	1.52	1.52	0.80	0.70	0.64	0.57
		1.78	9.00	5.23	3.88	3.14	3.14	1.65	1.43	1.31	1.18

		2.69	13.61	7.91	5.86	4.75	4.75	2.50	2.17	1.98	1.79
0.4 < HWP ≤ 0.5		1.08	5.84	3.18	2.36	1.90	1.90	1.00	0.87	0.79	0.72
		2.22	11.25	6.54	4.85	3.92	3.92	2.06	1.79	1.63	1.47
		3.37	17.01	9.88	7.33	5.94	5.94	3.12	2.72	2.48	2.23
0.5 < HWP ≤ 0.6		1.29	6.57	3.82	2.83	2.29	2.29	1.20	1.05	0.95	0.86
		2.67	13.50	7.84	5.82	4.71	4.71	2.47	2.15	1.96	1.77
		4.04	20.42	11.86	8.79	7.13	7.13	3.75	3.26	2.97	2.68
0.6 < HWP ≤ 0.9		1.94	9.86	5.73	4.25	3.43	3.43	1.80	1.57	1.43	1.29



		4.00	20.25	11.76	8.72	7.06	7.06	3.71	3.23	2.94	2.65
		6.06	30.62	17.79	13.19	10.70	10.70	5.62	4.89	4.46	4.02
0.9 < HWP ≤ 1.2		2.59	13.14	7.63	5.66	4.57	4.57	2.40	2.09	1.91	1.72
		5.33	27.00	15.68	11.63	9.41	9.41	4.95	4.30	3.92	3.54
		8.08	40.83	23.72	17.59	14.26	14.26	7.50	6.52	5.94	5.36

**Notes to Table 9.23.13.7.-A:**

- (1) Unadjusted minimum total *braced wall panel* lengths are for the applicable conditions corresponding to an adjustment factor of 1 in the equation for  $L_w$ .
- (2) See Sentence 9.23.3.5.(3) for a description of framing types and fastening requirements.
- (3) See Sentence (6) for *braced wall panels* with gypsum board installed on both sides.

**Table 9.23.13.7.-B**

**Adjustment Factors for the Determination of Minimum Total Braced Wall Panel Lengths for Wind**

**Forming Part of Sentence 9.23.13.7.(3)**

Symbol	Description	Storey	Condition	Adjustment Factor
$K_{exp}^{(1)}$	Wind exposure: apply factor to all <i>storeys</i> in both directions	All <i>storeys</i>	Rough terrain	1.00
		<u>All storeys in</u> 1 – <i>storey building</i>	Open terrain	1.29
		<u>All storeys in</u> 2 – <i>storey building</i>		1.40
		<u>All storeys in</u> 3 – <i>storey building</i>		1.48

K <sub>roof</sub> <sup>(2)</sup>	Roof eave-to-ridge height: apply factor separately to each storey	Storey supporting roof only	≤ 1.5 m	0.52
			3.0 m	1.00
			4.5 m	1.58
			6.0 m	1.99
		Storey supporting roof and 1 floor	≤ 1.5 m	0.79
			3.0 m	1.00
			4.5 m	1.26
			6.0 m	1.47
		Storey supporting roof and 2 floors	≤ 1.5 m	0.87
			3.0 m	1.00
			4.5 m	1.16
			6.0 m	1.31
K <sub>Wspacing</sub> <sup>(2)(3)(4)</sup>	Braced wall band spacing: apply factor to all braced wall panels per building plan direction	Any storey	3.8 m	0.51
			7.6 m	1.00
			10.6 m	1.35
			15 m <sup>(5)</sup>	1.86
K <sub>Wnumber</sub>	Number of parallel braced wall bands: apply factor to all braced wall panels per building plan direction	Any storey	2	1.00
			3	1.28
			4	1.38
			≥ 5	1.43
K <sub>gyp</sub>	Interior gypsum board: apply factor in accordance with whether gypsum board is installed or omitted on interior side of braced wall panels	Any storey	Installed	1.00
			Omitted, blocked wall	1.20
			Omitted, unblocked wall	1.40
K <sub>sheath</sub>	Intermittent braced wall panels: apply factor in accordance with continuity of sheathing within braced wall band	Any storey	Continuously sheathed	1.00
			Intermittently sheathed	1.15

**Notes to Table 9.23.13.7.-B:**

(1) K<sub>exp</sub> is determined based on the terrain. Rough terrain is suburban, urban, or wooded terrain extending upwind from the *building* uninterrupted for at least 1 km. Open terrain is level terrain with only scattered trees, *buildings* or other obstructions, open water or shorelines.

(2) For K<sub>roof</sub> linear interpolation between roof eave-to-ridge heights is permitted. <sup>3</sup> K<sub>Wspacing</sub> Linear interpolation between braced wall band spacing is permitted.

(4) An average braced wall band spacing is permitted to be used for the determination of K<sub>Wspacing</sub>. See Sentence (5).

(5) A braced wall band spacing of 15 m is only permitted in basements and crawl spaces.

4) For resistance to seismic forces, the minimum total length of braced wall panels in each braced wall band, L<sub>s</sub>, shall be determined by applying the adjustment factors provided in Table 9.23.13.7.-D to the unadjusted minimum total braced wall panel length, L<sub>usr</sub>, provided in Table 9.23.13.7.-C using the following equation:

$$L_s = L_{us} K_{weight} K_{snow} K_{spacing} K_{Snumber} K_{gyp} K_{sheath} \geq BWP_{min}$$

Where:

$K_{weight}$  = weight of construction and cladding adjustment factor, and  
 = 1 for normal-weight construction (see Sentence 9.23.13.2.(3)),

$K_{snow}$  = roof snow load adjustment factor, and  
 = 1 for a specified roof snow load of 2 kPa or less, as calculated in accordance with Article 9.4.2.2.,

$K_{spacing}$  = *braced wall band* spacing adjustment factor for seismic forces (see Sentence (5) per *building plan* direction, and

-  
 = 1 for a *braced wall band* spacing of 7.6 m,

$K_{Snumber}$  = number of parallel *braced wall bands* adjustment factor for seismic forces, per *building plan* direction, and

= 1 for two exterior walls and no intermediate *braced wall bands*,

$K_{gyp}$  = interior gypsum board adjustment factor, and  
 = 1 for *braced wall panels* with gypsum board installed on the interior side,

$K_{sheath}$  = intermittent *braced wall panels* adjustment factor, and  
 = 1 for continuously sheathed *braced wall bands*, and


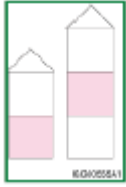
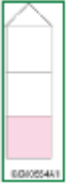

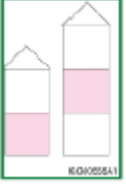
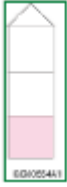
$BWP_{min}$  = minimum length of individual *braced wall panels*, per Table 9.23.13.5. (see Note A-9.23.13.7.(4) for an alternative procedure to calculate  $L_s$  directly and Note A-9.23.13.7.(3) and (4).)


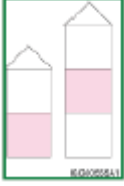
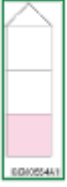

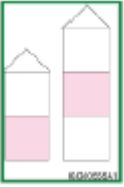
**Table 9.23.13.7.-C**



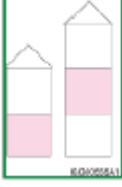
**Unadjusted Minimum Total Braced Wall Panel Lengths for Seismic Forces**

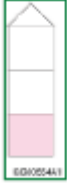

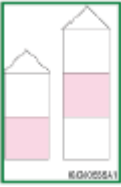
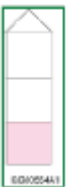
**Forming Part of Sentence 9.23.13.7.(4)**


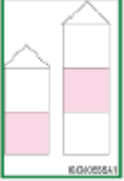
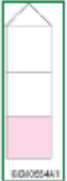
$S_{max}$	Storey	Building Plan Dimension Parallel to Braced Wall Band, $L_{wl}$ , m	Unadjusted Minimum Total <i>Braced Wall Panel</i> Length for Seismic Forces, $L_{us}$ , m <sup>(1)(2)</sup>									
			Diagonal-Lumber-Sheathed Framing Type (with gypsum board on opposite side) <sup>(3)</sup>	Gypsum-Sheathed Framing Type (with gypsum board on only one side) <sup>(3)(4)</sup>				Wood-Sheathed Framing Type (with gypsum board on opposite side) <sup>(3)</sup>				
				DWB	GWB-A	GWB-B	GWB-C	GWB-D	WSP-A	WSP-B	WSP-C	WSP-D
		3.1	0.06	0.47	0.27	0.20	0.17	0.11	0.06	0.05	0.05	0.04
		6.1	0.11	.81	0.47	0.35	0.28	0.19	0.10	0.09	0.08	0.07
		9.1	0.15	1.15	0.67	0.50	0.40	0.27	0.14	0.12	0.11	0.10
		12.2	0.20	1.5	0.87	0.65	0.53	0.35	0.18	0.16	0.15	0.13

$S_{max} \leq 0.2$		15.2	0.24	1.81	1.05	0.78	0.64	0.43	0.23	0.20	0.18	0.16	
		18.3	0.29	2.20	1.28	0.95	0.77	0.51	0.27	0.23	0.21	0.19	
		3.1	0.15	1.10	0.65	0.48	0.39	0.26	0.14	0.12	0.11	0.10	
		6.1	0.24	1.84	1.07	0.79	0.65	0.43	0.23	0.20	0.18	0.16	
		9.1	0.34	2.57	1.49	1.11	0.90	0.60	0.32	0.27	0.25	0.23	
		12.2	0.44	3.32	1.93	1.43	1.17	0.78	0.41	0.36	0.32	0.29	
		15.2	0.54	3.99	2.31	1.72	1.40	0.95	0.50	0.43	0.39	0.36	
		18.3	0.64	4.80	2.79	2.07	1.68	1.12	0.59	0.51	0.47	0.42	
		3.1	0.23	1.76	1.02	0.76	0.62	0.41	0.22	0.19	0.17	0.15	
		6.1	0.38	2.87	1.67	1.24	1.01	0.67	0.35	0.31	0.28	0.25	
		9.1	0.53	3.99	1.49	1.72	1.40	0.93	0.49	0.43	0.39	0.35	
		12.2	0.68	5.14	2.99	2.21	1.80	1.20	0.63	0.55	0.50	0.45	
		15.2	0.83	6.16	3.58	2.65	2.16	1.46	0.77	0.67	0.61	0.55	
		18.3	0.98	7.41	4.30	3.19	2.60	1.73	0.91	0.79	0.72	0.65	
	$0.2 < S_{max} \leq 0.4$		3.1	0.13	0.94	0.55	0.41	0.33	0.22	0.12	0.10	0.09	0.08
			6.1	0.22	1.63	0.94	0.70	0.57	0.38	0.20	0.17	0.16	0.14
			9.1	0.31	2.31	1.34	0.99	0.81	0.54	0.28	0.25	0.22	0.20
			12.2	0.40	3.01	1.75	1.30	1.05	0.70	0.37	0.32	0.29	0.26
15.2			0.49	3.63	2.11	1.56	1.27	0.86	0.45	0.39	0.36	0.32	
18.3			0.58	4.39	2.55	1.89	1.54	1.03	0.54	0.47	0.43	0.39	
		3.1	0.30	2.23	1.30	0.96	0.78	0.52	0.27	0.24	0.22	0.20	
		6.1	0.49	3.69	2.14	1.59	1.29	0.86	0.45	0.39	0.36	0.32	
		9.1	0.68	5.14	2.99	2.21	1.80	1.20	0.63	0.55	0.50	0.45	
		12.2	0.88	6.65	3.86	2.86	2.33	1.55	0.82	0.71	0.65	0.58	
		15.2	1.07	7.97	4.63	3.43	2.79	1.89	1.00	0.87	0.79	0.71	
		18.3	1.27	9.61	5.58	4.14	3.37	2.25	1.18	1.03	0.94	0.84	
		3.1	0.47	DR (1.12)	2.04	1.51	1.23	0.82	0.43	0.38	0.34	0.31	
		6.1	0.76	5.50	3.34	2.48	2.01	1.34	0.71	0.61	0.56	0.50	
		9.1	1.06	7.98	4.63	3.44	2.80	1.86	0.98	0.85	0.78	0.70	
		12.2	1.36	10.29	5.97	4.43	3.61	2.40	1.26	1.10	1.00	0.90	
		15.2	1.66	12.31	7.15	5.30	4.32	2.93	1.54	1.34	1.22	1.10	
		18.3	1.96	14.82	8.61	6.38	5.20	3.46	1.82	1.58	1.44	1.30	


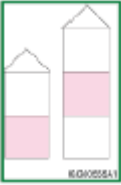
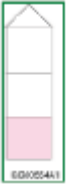
0.4 < S <sub>max</sub> ≤ 0.6		3.1	0.19	1.42	0.82	0.61	0.50	0.33	0.17	0.15	0.14	0.12
		6.1	0.32	2.44	1.42	1.05	0.85	0.57	0.30	0.26	0.24	0.21
		9.1	0.46	3.46	2.01	1.49	1.21	0.81	0.42	0.37	0.34	0.30
		12.2	0.60	4.51	2.62	1.94	1.58	1.05	0.55	0.48	0.44	0.40
		15.2	0.73	5.44	3.16	2.34	1.91	1.29	0.68	0.59	0.54	0.49
		18.3	0.87	6.59	3.83	2.84	2.31	1.54	0.81	0.70	0.64	0.58
		3.1	0.44	DR (1.67)	1.94	1.44	1.17	0.78	0.41	0.36	0.33	0.29
		6.1	0.73	5.53	3.21	2.38	1.94	1.29	0.68	0.59	0.54	0.49
		9.1	1.02	7.71	4.48	3.32	2.70	1.80	0.95	0.82	0.75	0.68
		12.2	1.32	9.97	5.79	4.29	3.50	2.33	1.23	1.07	0.97	0.88
		15.2	1.61	11.96	6.94	5.15	4.19	2.84	1.49	1.30	1.18	1.07
		18.3	1.91	14.41	8.37	6.21	5.05	3.37	1.77	1.54	1.40	1.27
		3.1	0.70	DR (2.64)	3.06	2.27	1.85	1.23	0.65	0.56	0.51	0.46
		6.1	1.14	DR (4.31)	5.01	3.71	3.02	2.01	1.06	0.92	0.84	0.76
		9.1	1.59	DR (5.99)	6.95	5.15	4.20	2.80	1.47	1.28	1.17	1.05
		12.2	2.04	DR (7.72)	8.96	6.64	5.41	3.61	1.90	1.65	1.50	1.35
		15.2	2.49	DR (9.24)	10.73	7.96	6.48	4.39	2.31	2.01	1.83	1.65
		18.3	2.95	DR (11.12)	12.91	9.58	7.80	5.20	2.73	2.38	2.17	1.95
0.6 < S <sub>max</sub> ≤ 0.8		3.1	0.25	1.89	1.10	0.81	0.66	0.44	0.23	0.20	0.18	0.17
		6.1	0.43	3.25	1.89	1.40	1.14	0.76	0.40	0.35	0.32	0.29
		9.1	0.61	4.61	2.68	1.99	1.62	1.08	0.57	0.49	0.45	0.40
		12.2	0.80	6.02	3.49	2.59	2.11	1.41	0.74	0.64	0.59	0.53
		15.2	0.98	7.25	4.21	3.12	2.54	1.72	0.91	0.79	0.72	0.65
		18.3	1.16	8.78	5.10	3.78	3.08	2.05	1.08	0.94	0.86	0.77
		3.1	0.59	DR (2.23)	2.59	1.92	1.56	1.04	0.55	0.48	0.43	0.39
		6.1	0.98	DR (3.69)	4.28	3.18	2.58	1.72	0.91	0.79	0.72	0.65
		9.1	1.36	DR (5.14)	5.97	4.43	3.61	2.40	1.26	1.10	1.00	0.90
		12.2	1.76	DR	7.72	5.73	4.66	3.11	1.63	1.42	1.29	1.17

		(6.65)											
		15.2	2.15	DR (7.97)	9.26	6.87	5.59	3.79	1.99	1.73	1.58	1.42	
		18.3	2.55	DR (9.61)	11.16	8.28	6.74	4.49	2.36	2.05	1.87	1.69	
		3.1	0.93	DR (2.04)	DR	3.03	2.46	1.64	0.86	0.75	0.68	0.62	
		6.1	1.52	DR (5.75)	DR (3.34)	4.95	4.03	2.69	1.41	1.23	1.12	1.01	
		9.1	2.11	DR (7.98)	DR (4.64)	6.87	5.59	3.73	1.96	1.71	1.55	1.40	
		12.2	2.72	DR (10.29)		11.95	8.86	7.21	4.81	2.53	2.20	2.00	1.81
		15.2	3.32	DR (12.32)		14.30	10.61	8.63	5.85	3.08	2.68	2.44	2.20
		18.3	3.93	DR (14.83)		17.22	12.77	10.39	6.93	3.64	3.17	2.89	2.60
	0.8 < S <sub>max</sub> ≤ 1.2		3.1	0.38	2.83	1.65	1.22	0.99	0.66	0.35	0.30	0.28	0.25
			6.1	0.65	4.88	2.83	2.10	1.71	1.14	0.60	0.52	0.47	0.43
			9.1	0.92	6.92	4.02	2.98	2.42	1.62	0.85	0.74	0.67	0.61
			12.2	1.20	9.03	5.24	3.89	3.16	2.11	1.11	0.96	0.88	0.79
15.2			1.47	10.88	6.32	4.69	3.81	2.59	1.36	1.18	1.08	0.97	
18.3			1.75	13.18	7.65	5.67	4.62	3.08	1.62	1.41	1.28	1.16	
		3.1	0.89	DR (1.95)	DR	2.88	2.35	1.56	0.82	0.71	0.65	0.59	
		6.1	1.46	DR (5.53)	DR (3.21)	4.76	3.88	2.58	1.36	1.18	1.08	0.97	
		9.1	2.04	DR (7.72)		8.96	6.64	5.41	3.61	1.90	1.65	1.50	1.35
		12.2	2.64	DR (9.97)		11.58	8.59	6.99	4.66	2.45	2.13	1.94	1.75
		15.2	3.22	DR (11.96)		13.89	10.30	8.38	5.68	2.99	2.60	2.37	2.13
		18.3	3.82	DR (14.41)		16.74	12.41	10.11	6.74	3.54	3.08	2.81	2.53
	3.1	1.40	DR	DR (3.06)	DR (2.27)	DR (1.85)	2.46	1.30	1.13	1.03	0.93		
	6.1	2.28	DR	DR	DR	6.04	4.03	2.12	1.84	1.68	1.51		

					(5.01)	(3.72)							
		9.1	3.17	DR	DR (6.95)	DR (5.16)	8.39	5.59	2.94	2.56	2.33	2.10	
		12.2	4.09	DR	DR (8.96)	DR (6.65)	10.82	7.21	3.79	3.30	3.01	2.71	
		15.2	4.97	DR	DR (10.73)	DR (7.96)	12.95	8.78	4.61	4.01	3.66	3.30	
		18.3	5.89	DR	DR (12.92)	DR (9.58)	15.59	10.39	5.46	4.75	4.33	3.90	
$1.2 < S_{max} \leq 1.6$		3.1	0.50	DR (1.89)	2.19	1.63	1.32	0.88	0.46	0.40	0.37	0.33	
		6.1	0.86	DR (3.25)	3.78	2.80	2.28	1.52	0.80	0.69	0.63	0.57	
		9.1	1.22	DR (4.61)	5.36	3.67	3.23	2.16	1.13	0.99	0.90	0.81	
		12.2	1.59	12.03	6.99	5.18	4.22	2.81	1.48	1.29	1.17	1.06	
		15.2	1.95	14.51	8.43	6.25	5.09	3.45	1.81	1.58	1.44	1.30	
		18.3	2.33	17.57	10.20	7.57	6.16	4.11	2.16	1.88	1.71	1.54	
		3.1	1.18	DR	DR (2.59)	DR (1.92)	3.13	2.08	1.10	0.95	0.87	0.78	
		6.1	1.95	DR	DR (4.28)	DR (3.18)	5.17	3.45	1.81	1.58	1.44	1.29	
		9.1	2.72	DR	DR (5.98)	8.86	7.21	4.81	2.53	2.20	2.00	1.81	
		12.2	3.52	DR	DR (7.72)	11.45	9.32	6.21	3.27	2.84	2.59	2.33	
		15.2	4.29	DR	DR (9.26)	13.73	11.18	7.58	3.98	3.46	3.16	2.85	
		18.3	5.09	DR	DR (11.16)	16.55	13.47	8.98	4.72	4.11	3.74	3.37	
		3.1	1.86	DR	DR	DR (3.03)	DR (2.47)	DR	DR	1.73	1.50	1.37	1.23
		6.1	3.05	DR	DR	DR (4.95)	DR (4.03)	5.37	2.82	2.46	2.24	2.02	
		9.1	4.23	DR	DR	DR (6.87)	DR (5.60)	7.46	3.92	3.41	3.11	2.80	
		12.2	5.45	DR	DR (11.95)	DR (8.86)	DR (7.21)	9.62	5.06	4.40	4.01	3.61	

		15.2	6.63	DR	DR (14.31)	DR (10.61)	DR (8.64)	11.70	6.15	5.35	4.88	4.40	
		18.3	7.85	DR	DR (17.22)	DR (12.77)	DR (10.40)	13.86	7.29	6.34	5.78	5.21	
1.6 < S <sub>max</sub> ≤ 2.0		3.1	0.63	DR	2.74	2.03	1.66	1.10	0.58	0.50	0.46	0.41	
		6.1	1.08	DR (4.07)	4.72	3.50	2.85	1.90	1.00	0.87	0.79	0.71	
		9.1	1.53	DR (5.77)	6.70	4.96	4.04	2.69	1.42	1.23	1.12	1.01	
		12.2	1.99	DR (7.52)	8.74	6.48	5.27	3.52	1.85	1.61	1.47	1.32	
		15.2	2.44	DR (9.07)	10.53	7.81	6.36	4.31	2.27	1.97	1.80	1.62	
		18.3	2.91	DR (10.98)	12.75	9.46	7.70	5.13	2.70	2.35	2.14	1.93	
		3.1	1.48	DR	DR	DR (2.40)	DR (1.96)	2.61	1.37	1.19	1.09	0.98	
		6.1	2.44	DR	DR	DR (5.35)	DR (3.97)	4.31	2.26	1.97	1.80	1.62	
		9.1	3.41	DR	DR	DR (7.47)	DR (5.54)	6.01	3.16	2.75	2.50	2.26	
		12.2	4.40	DR	DR	DR (9.65)	DR (7.16)	11.65	7.77	4.08	3.55	3.24	2.92
		15.2	5.37	DR	DR	DR (11.08)	DR (8.58)	13.97	9.47	4.98	4.33	3.95	3.56
		18.3	6.36	DR	DR	DR (13.95)	DR (10.35)	16.84	11.23	5.90	5.13	4.68	4.22
		3.1	2.33	DR	DR	DR	DR (3.08)	DR	2.16	1.88	1.71	1.54	
		6.1	3.81	DR	DR	DR	DR (5.04)	DR	3.53	3.07	2.80	2.52	
		9.1	5.28	DR	DR	DR (8.59)	DR (7.00)	DR	4.90	4.26	3.89	3.50	
		12.2	6.81	DR	DR	DR (11.08)	DR (9.02)	12.02	6.32	5.50	5.01	4.51	
		15.2	8.29	DR	DR	DR (13.26)	DR (11.00)	14.63	7.69	6.69	6.10	5.49	
		18.3	9.82	DR	DR	DR	DR	17.32	9.11	7.92	7.22	6.51	



						(15.96)	(13.00)					
2.0 < S <sub>max</sub> ≤ 2.6		3.1	0.81	DR (3.07)	DR (1.79)	2.65	2.15	1.44	0.75	0.66	0.60	0.54
		6.1	1.40	DR (5.28)	DR (3.07)	4.55	3.70	2.47	1.30	1.13	1.03	0.93
		9.1	1.99	DR (7.50)	8.70	6.45	5.25	3.50	1.84	1.60	1.46	1.32
		12.2	2.59	DR (9.78)	11.36	8.42	6.86	4.57	2.40	2.09	1.90	1.72
		15.2	3.18	DR (11.79)	13.69	10.15	8.27	5.60	2.95	2.56	2.34	2.11
		18.3	3.78	DR (14.28)	16.58	12.30	10.01	6.67	3.51	3.05	2.78	2.51
		3.1	1.92	DR	DR	DR	DR (2.54)	DR	1.78	1.55	1.41	1.27
		6.1	3.17	DR	DR	DR (5.16)	DR (4.20)	5.60	2.94	2.56	2.33	2.10
		9.1	4.43	DR	DR	DR (7.20)	DR (5.86)	7.81	4.11	3.57	3.26	2.93
		12.2	5.72	DR	DR	DR (9.31)	DR (7.58)	10.10	5.31	4.62	4.21	3.79
		15.2	6.98	DR	DR (15.05)	DR (11.16)	DR (9.58)	12.31	6.47	5.63	5.13	4.62
		18.3	8.27	DR	DR (18.14)	DR (13.45)	DR (10.95)	14.60	7.67	6.67	6.08	5.48
		3.1	3.03	DR	DR	DR	DR	DR	2.81	2.44	2.23	2.01
		6.1	4.95	DR	DR	DR	DR	DR	4.59	3.99	3.64	3.28
		9.1	6.87	DR	DR	DR	DR (9.09)	DR	6.37	5.54	5.05	4.55
		12.2	8.86	DR	DR	DR	DR (11.72)	DR	8.22	7.14	6.51	5.87
		15.2	10.78	DR	DR	DR	DR (14.03)	DR	10.00	8.69	7.92	7.14
		18.3	12.76	DR	DR	DR	DR (16.89)	DR	11.84	10.30	9.38	8.46

**Notes to Table 9.23.13.7.-C:**

(1) Unadjusted minimum total *braced wall panel* lengths are for the applicable conditions corresponding to an adjustment factor of 1 in the equation for L<sub>s</sub>.

(2) DR = design required, using the procedure outlined in Note A-9.23.13.7.(4) or according to Part 4, for *braced wall panels* with typical sheathing.  $L_{us}$  values within round brackets, to which the reduction set out in Sentence (6) has been applied, are permitted for *braced wall panels* with gypsum board installed on both sides.

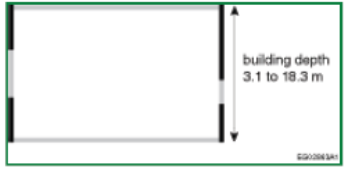
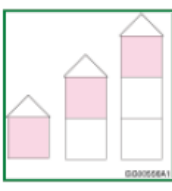
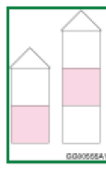
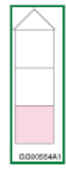
(3) See Sentence 9.23.3.5.(3) for a description of framing types and fastening requirements.

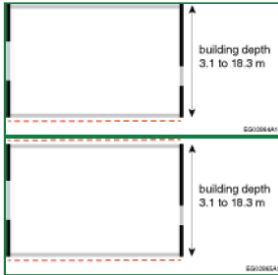
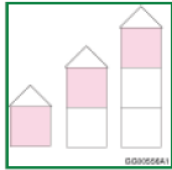
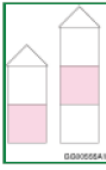
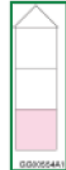
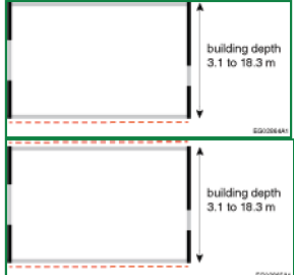
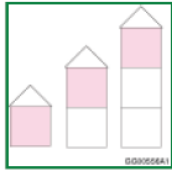
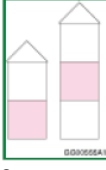
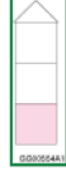
(4) See Sentence (6) for *braced wall panels* with gypsum board installed on both sides.

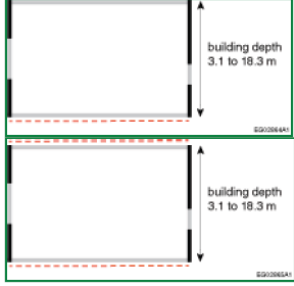

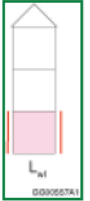
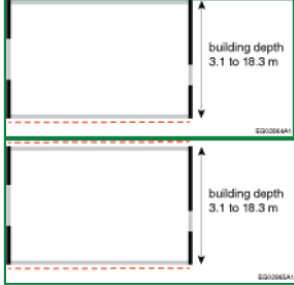
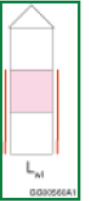


**Table 9.23.13.7.-D**

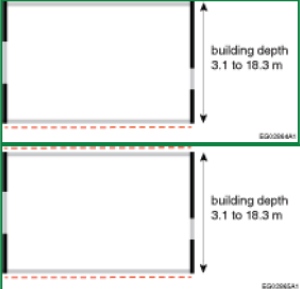
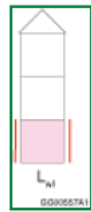
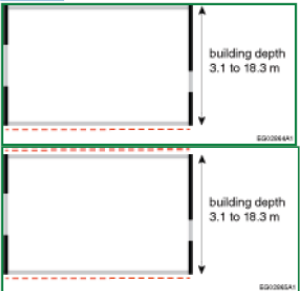
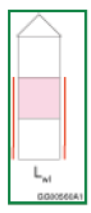
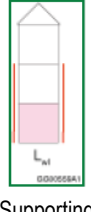
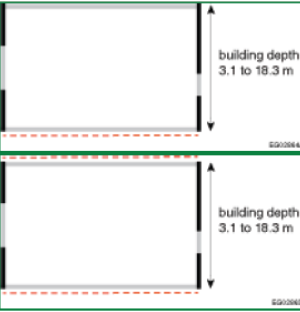
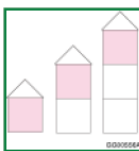
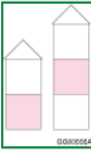
**Adjustment Factors for the Determination of Minimum Total Braced Wall Panel Lengths for Seismic Forces**

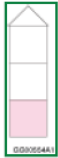
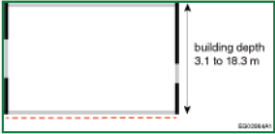
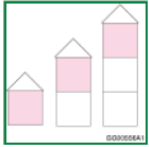
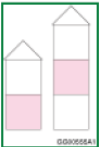
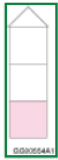
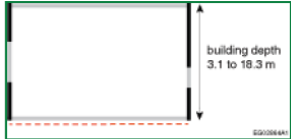
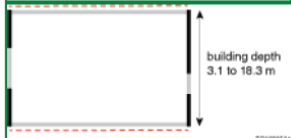
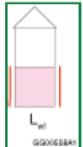

**Forming Part of Sentence 9.23.13.7.(4)**

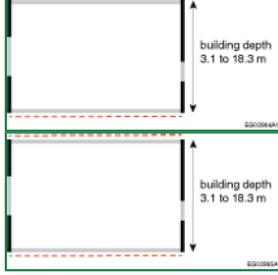
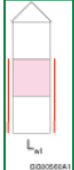

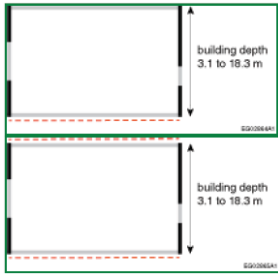
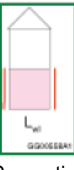

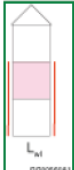

Symbol	Description	Storey	Condition	Adjustment Factor	
$K_{weight}^{(1)/(2)}$	Normal-weight construction	Any storey	Any $L_{wl}$	1.0	
	Heavy construction: apply factor corresponding to $L_{wl}$ separately to each storey 	 Storey supporting roof only	Building depth	1.72	
			$L_{wl} \leq 3.1$ m		
			$L_{wl} = 6.1$ m	1.54	
			$L_{wl} = 9.1$ m	1.46	
			$L_{wl} = 12.2$ m	1.42	
			$L_{wl} = 15.2$ m	1.39	
		$L_{wl} \geq 18.3$ m	1.38		
		 Storey supporting roof and 1 floor	$L_{wl} \leq 3.1$ m	1.92	
			$L_{wl} = 6.1$ m	1.71	
			$L_{wl} = 9.1$ m	1.62	
			$L_{wl} = 12.2$ m	1.57	
			$L_{wl} = 15.2$ m	1.54	
			$L_{wl} \geq 18.3$ m	1.51	
		 Storey supporting roof and 2 floors	$L_{wl} \leq 3.1$ m	1.97	
			$L_{wl} = 6.1$ m	1.76	
			$L_{wl} = 9.1$ m	1.67	
			$L_{wl} = 12.2$ m	1.61	
			$L_{wl} = 15.2$ m	1.58	
	$L_{wl} \geq 18.3$ m		1.56		
	Masonry veneer half storey above foundation: apply factor corresponding to one building face (or two building faces)	Storey supporting roof and up to 2 floors	Any $L_{wl}$	1.00	Two Building Faces (value)
	Masonry veneer cladding perpendicular to braced wall band, fully clad: <sup>(3)</sup> apply		$L_{wl} \leq 3.1$ m	1.54	2.13
			$L_{wl} = 6.1$ m	1.30	1.64

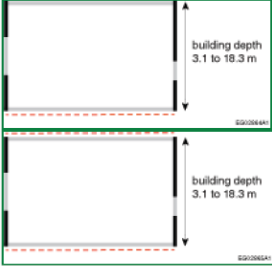

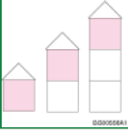


<p>factor corresponding to <math>L_{wi}</math> for one building face (or two building faces)</p> 	 <p>Storey supporting roof only</p>	$L_{wi} = 9.1$ m 1.21 1.45	12.2 m 1.15 1.34	15.2 m 1.12 1.28	$\geq 18.3$ m 1.10 1.23			
	 <p>Storey supporting roof and 1 floor</p>	$\leq 3.1$ m 1.69 2.43	6.1 m 1.40 1.85	9.1 m 1.28 1.60	12.2 m 1.21 1.46	15.2 m 1.17 1.38	$\geq 18.3$ m 1.14 1.31	
	 <p>Storey supporting roof and 2 floors</p>	$\leq 3.1$ m 1.73 2.51	6.1 m 1.43 1.91	9.1 m 1.30 1.65	12.2 m 1.22 1.50	15.2 m 1.18 1.41	$\geq 18.3$ m 1.15 1.33	
	<p>Masonry veneer cladding perpendicular to braced wall band, partially clad:<sup>(3)</sup> apply factor corresponding to <math>L_{wi}</math> for one building face (or two building faces)</p> 	 <p>Storey supporting roof only</p>	$\leq 3.1$ m 1.23 1.52	6.1 m 1.13 1.29	9.1 m 1.08 1.20	12.2 m 1.06 1.15	15.2 m 1.04 1.12	$\geq 18.3$ m 1.03 1.09
		 <p>Storey supporting roof and 1 floor</p>	$\leq 3.1$ m 1.30 1.66	6.1 m 1.17 1.39	9.1 m 1.11 1.27	12.2 m 1.08 1.20	15.2 m 1.06 1.16	$\geq 18.3$ m 1.05 1.13
		 <p>Storey supporting roof and 2 floors</p>	$\leq 3.1$ m 1.31 1.70	6.1 m 1.18 1.42	9.1 m 1.12 1.29	12.2 m 1.08 1.21	15.2 m 1.07 1.17	$\geq 18.3$ m 1.05 1.14
		<p>Masonry veneer cladding perpendicular to the braced wall band, 1-storey height,</p>		$\leq 3.1$ m 1.23 1.48	6.1 m 1.13 1.28			

<p>partially clad:<sup>(3)</sup> apply factor corresponding to <math>L_{wl}</math> for one <i>building face</i> (or two <i>building faces</i>)</p> 	 <p>Storey supporting roof and 1 floor</p>	9.1 m	1.09	1.20
		12.2 m	1.07	1.15
		15.2 m	1.06	1.13
		$\geq 18.3$ m	1.05	1.10
	 <p>Storey supporting roof and 2 floors</p>	$\leq 3.1$ m	1.15	1.30
		6.1 m	1.09	1.18
		9.1 m	1.06	1.13
		12.2 m	1.04	1.10
		15.2 m	1.04	1.08
		$\geq 18.3$ m	1.03	1.07
<p>Masonry veneer cladding perpendicular to the <i>braced wall band</i>, 2-storey height, partially clad:<sup>(3)</sup> apply factor corresponding to <math>L_{wl}</math> for one <i>building face</i>( or two <i>building faces</i>)</p> 	 <p>Storey supporting roof and 1 floor</p>	$\leq 3.1$ m	1.10	1.22
		6.1 m	1.06	1.13
		9.1 m	1.04	1.09
		12.2 m	1.03	1.07
		15.2 m	1.02	1.05
		$\geq 18.3$ m	1.02	1.04
	 <p>Supporting roof + 2 floors</p>	$\leq 3.1$ m	1.19	1.42
		6.1 m	1.11	1.25
		9.1 m	1.07	1.17
		12.2 m	1.05	1.13
		15.2 m	1.04	1.10
		$\geq 18.3$ m	1.03	1.08
<p>Masonry veneer cladding perpendicular to the <i>braced wall band</i>, 2 storey height, fully clad:</p> <p>Apply factor corresponding to <i>building depth</i> <math>L_{wl}</math> in the direction of the <i>braced wall band</i> for one or two <i>building face(s)</i></p> 	<p>Supporting roof + 1 floor</p>	$\leq 3.1$ m	1.23	1.48
		6.1 m	1.13	1.28
		9.1 m	1.09	1.20
		12.2 m	1.07	1.15
		15.2 m	1.06	1.13
	$\geq 18.3$ m	1.05	1.10	
		$\leq 3.1$ m	1.15	1.30
		6.1 m	1.09	1.18
		9.1 m	1.06	1.13
		12.2 m	1.04	1.10
15.2 m		1.04	1.08	

	 <p>Supporting roof + 2 floors</p>	$\geq 18.3$ m	1.03	1.07
<p>Masonry veneer cladding perpendicular to the braced wall band, 1 storey height, fully clad:</p> <p>Apply factor corresponding to <i>building depth</i> <math>L_{wl}</math> in the direction of the <i>braced wall band</i> for one or two <i>building face(s)</i></p> 	 <p>Supporting roof + 1 floor</p>	$\leq 3.1$ m	1.23	1.48
	6.1 m	1.13	1.28	
	9.1 m	1.09	1.20	
	12.2 m	1.07	1.15	
	15.2 m	1.06	1.13	
	$\geq 18.3$ m	1.05	1.10	
	 <p>Supporting roof + 2 floors</p>	$\leq 3.1$ m	1.44	1.91
	6.1 m	1.26	1.55	
	9.1 m	1.18	1.39	
	12.2 m	1.13	1.30	
15.2 m	1.11	1.24		
$\geq 18.3$ m	1.09	1.20		
Stone veneer <sup>(2)</sup>		<i>Building depth</i>	One face	Both faces
Stone veneer half storey above foundation	Supporting up to a roof + 2 floors		1.00	1.00
<p>Stone veneer cladding perpendicular to braced wall band, fully clad (4) :</p> <p>Apply factor corresponding to <i>building depth</i> in the direction of the <i>braced wall band</i> for one or two <i>building face(s)</i></p> 	 <p>Supporting roof only</p>	$\leq 3.1$ m	1.95	2.95
	6.1 m	1.54	2.13	
	9.1 m	1.38	1.79	
	12.2 m	1.28	1.60	
	15.2 m	1.23	1.49	
	$\geq 18.3$ m	1.19	1.40	
	 <p>Supporting roof + 1 floor</p>	$\leq 3.1$ m	2.21	3.48
	6.1 m	1.72	2.50	
	9.1 m	1.51	2.06	
	12.2 m	1.38	1.82	
	15.2 m	1.31	1.66	
	$\geq 18.3$ m	1.26	1.55	
	$\leq 3.1$ m	2.28	3.63	

			Supporting roof + 2 floors	6.1 m	1.77	2.60	
				9.1 m	1.55	2.14	
				12.2 m	1.41	1.88	
				15.2 m	1.33	1.72	
				≥ 18.3 m	1.28	1.60	
<p>Stone veneer cladding perpendicular to <i>braced wall band</i>, partially clad<sup>(4)</sup>:</p> <p>Apply factor corresponding to <i>building depth</i> in the direction of the <i>braced wall band</i> for one or two <i>building face(s)</i></p> 		Supporting roof only	≤ 3.1 m	1.44	1.94		
			6.1 m	1.25	1.54		
			9.1 m	1.17	1.37		
			12.2 m	1.13	1.28		
			15.2 m	1.10	1.23		
			≥ 18.3 m	1.08	1.18		
				Supporting roof + 1 floor	≤ 3.1 m	1.56	2.19
					6.1 m	1.33	1.71
					9.1 m	1.22	1.50
					12.2 m	1.17	1.38
					15.2 m	1.13	1.31
					≥ 18.3 m	1.11	1.25
				Supporting roof + 2 floors	≤ 3.1 m	1.59	2.26
					6.1 m	1.35	1.76
9.1 m	1.24	1.53					
12.2 m	1.18	1.41					
15.2 m	1.14	1.33					
≥ 18.3 m	1.12	1.27					
<p>Stone veneer cladding perpendicular to the <i>braced wall band</i>, 1 storey height, with openings:</p> <p>Apply factor corresponding to depth <math>L_w</math> in the direction of the <i>braced wall band</i> for one or two <i>building face(s)</i>.</p>  		Supporting roof + 1 floor	≤ 3.1 m	1.19	1.40		
			6.1 m	1.11	1.24		
			9.1 m	1.07	1.17		
			12.2 m	1.06	1.13		
			15.2 m	1.04	1.10		
			≥ 18.3 m	1.04	1.10		
		Supporting roof + 2 floors	≤ 3.1 m	1.12	1.25		
			6.1 m	1.07	1.15		
			9.1 m	1.05	1.11		
			12.2 m	1.04	1.08		
			15.2 m	1.03	1.07		
			≥ 18.3 m	1.02	1.05		

<p>Stone veneer cladding perpendicular to the <i>braced wall band</i>, 2 storey height, with openings:</p> <p>Apply factor corresponding to depth <math>L_{wi}</math> in the direction of the <i>braced wall band</i> for one or two <i>building face(s)</i>.</p> 	 <p>Supporting roof + 1 floor</p>	$\leq 3.1$ m 6.1 m 9.1 m 12.2 m 15.2 m $\geq 18.3$ m	1.19 1.11 1.07 1.06 1.04 1.04	1.40 1.24 1.17 1.13 1.10 1.08		
	 <p>Supporting roof + 2 floors</p>	$\leq 3.1$ m 6.1 m 9.1 m 12.2 m 15.2 m $\geq 18.3$ m	1.36 1.21 1.14 1.11 1.09 1.07	1.76 1.45 1.32 1.24 1.20 1.16		
	<p>Stone veneer cladding perpendicular to the <i>braced wall band</i>, 1 storey height, fully clad:</p> <p>Apply factor corresponding to depth <math>L_{wi}</math> in the direction of the <i>braced wall band</i> for one or two <i>building face(s)</i>.</p> 	 <p>Supporting roof + 1 floor</p>	$\leq 3.1$ m 6.1 m 9.1 m 12.2 m 15.2 m $\geq 18.3$ m	1.40 1.24 1.17 1.13 1.10 1.09	1.83 1.50 1.35 1.27 1.22 1.18	
		 <p>Supporting roof + 2 floors</p>	$\leq 3.1$ m 6.1 m 9.1 m 12.2 m 15.2 m $\geq 18.3$ m	1.26 1.15 1.11 1.08 1.07 1.06	1.53 1.32 1.23 1.18 1.14 1.12	
		<p>Stone veneer cladding perpendicular to the <i>braced wall band</i>, 2 storey height, fully clad:</p> <p>Apply factor corresponding to depth <math>L_{wi}</math> in the direction of the <i>braced wall band</i> for one or two <i>building face(s)</i>.</p>  <p>Supporting roof + 1 floor</p>	$\leq 3.1$ m 6.1 m 9.1 m 12.2 m 15.2 m $\geq 18.3$ m	1.40 1.24 1.17 1.13 1.10 1.09	1.83 1.50 1.35 1.27 1.22 1.18	
				$\leq 3.1$ m 6.1 m 9.1 m 12.2 m 15.2 m	1.77 1.46 1.33 1.25 1.20	2.58 1.96 1.68 1.53 1.43

		 <p>Supporting roof + 2 floors</p>	$\geq 18.3$ m	1.17	1.36
$K_{\text{snow}}^{(4)}$	Roof snow load: apply factor in accordance with the specified roof snow load	 <p>Storey supporting roof only</p>	$\leq 2$ kPa	1.00	
			3 kPa	1.20	
			4 kPa	1.40	
			5 kPa	1.60	
			6 kPa	1.80	
		 <p>Storey supporting roof and 1 floor</p>	$\leq 2$ kPa	1.00	
			3 kPa	1.10	
			4 kPa	1.20	
			5 kPa	1.30	
		 <p>Storey supporting roof and 2 floors</p>	$\leq 2$ kPa	1.00	
			3 kPa	1.06	
4 kPa	1.10				
5 kPa	1.20				
$K_{\text{spacing}}^{(5)}$ (6)	Braced wall band spacing: apply factor to all braced wall panels per building plan direction	Any storey	3.8 m	0.60	
			7.6 m	1.00	
			10.6 m	1.35	
			15 m <sup>(7)</sup>	1.90	
$K_{\text{number}}$	Number of parallel braced wall bands: apply factor to all braced wall panels per building plan direction	Any storey	2	1.00	
			3	1.33	
			4	1.50	
			$\geq 5$	1.60	
$K_{\text{gyp}}$	Interior gypsum board: apply factor in accordance with whether gypsum board is installed or omitted on interior side of braced wall panels	Any storey	Installed	1.00	
			Omitted, blocked wall	1.20	
			Omitted, unblocked wall	1.40	
$K_{\text{sheath}}$	Intermittent braced wall panels: apply factor in accordance with continuity of sheathing within braced wall band	Any storey	Continuously wood-sheathed	1.00	
			Intermittently sheathed	1.15	

Notes to Table 9.23.13.7.-D:



- (1) See Sentence 9.23.13.2.(3).
- (2) For  $K_{\text{weight}}$ , linear interpolation between  $L_{\text{wl}}$  values and between fully clad and partially clad veneer conditions is permitted.
- (3) "Fully clad" means that there are no openings, and "partially clad" means 50% or less coverage of an elevation.
- (4) For  $K_{\text{snow}}$ , linear interpolation between roof snow loads is permitted.
- (5) For  $K_{\text{spacing}}$ , linear interpolation between *braced wall band* spacings is permitted.
- (6) An average *braced wall band* spacing is permitted to be used for the determination of  $K_{\text{spacing}}$ . See Sentence (5).
- (7) A braced wall band spacing of 15 m is only permitted in *basements* and crawl spaces. between roof snow loads for  $K_{\text{snow}}$  and between *braced wall band* spacings for  $K_{\text{spacing}}$ , and between *building* depths and between fully clad and partially clad veneer conditions for  $K_{\text{weight}}$ .

5) For 3 or more parallel *braced wall bands* that are not evenly spaced, an average *braced wall band* spacing is permitted to be used for the determination of  $K_{\text{Wspacing}}$  or  $K_{\text{Sspacing}}$ , provided that no single *braced wall band* spacing exceeds 10.6 m, except as provided in Sentence 9.23.13.6.(3).

6) Where *braced wall panels* of a gypsum-sheathed framing type have gypsum board installed on both sides, the minimum total length of the *braced wall panels* determined in Sentence 9.23.13.7.(3) or (4) is permitted to be reduced by 50%.

### 9.23.13.8. Foundation Cripple Walls

(See Note A-9.23.13.8.)

- 1) Except as provided in Sentences (2) and (3), *foundation* cripple walls supporting *braced wall panels* shall be
- considered as an additional *storey*, or
  - designed in accordance with Part 4.
- 2) Where the seismic design parameter,  $S_{\text{max}}$ , is less than or equal to 0.60, *foundation* cripple walls need not comply with Sentence (1), provided they
- are not more than 1.2 m in height,
  - are not more than 6 m in length,
  - are either
    - framed with solid blocking, or
    - of the same construction as the *braced wall panels* of the *storey* above but sheathed with wood sheathing regardless of the construction, where the length of the cripple wall bracing is equal to the length of the *braced wall panels* multiplied by an adjustment factor of 1.2, in addition to any adjustments required by Sentences 9.23.13.7.(1) and (2), and
  - do not support heavyweight construction, masonry or stone veneer.

(See Note A-9.23.13.8.(2).)

- 3) Where the seismic design parameter,  $S_{\text{max}}$ , is greater than 0.60, *foundation* cripple walls need not comply with Sentence (1), provided they
- comply with Clauses (2)(c) and (d),
  - are not more than 350 mm in height, and
  - are not more than 5 m length,

(See Note A-9.23.13.8.(3).)

4) Where interior finish, such as gypsum board, is omitted from the interior side of the cripple wall referred to in Sentence (2) or (3), the interior gypsum board adjustment factor described in Sentence 9.23.13.7.(3) or (4) shall be applied to the length of the cripple wall bracing.

#### **9.23.13.9. Cripple Walls in Stepped Foundations**

1) Cripple walls in stepped *foundations* need not be braced in accordance with Sentences 9.23.13.8.(2) to (4), provided

a) the lowest floor framing rests directly on a sill plate anchored to a *foundation* not less than 2.4 m in length within a *braced wall band* not more than 7.6 m in length,

b) the top plate of the cripple wall extends not less than 1.2 m along the *foundation*, and

c) anchor bolts are located not more than 300 mm and 900 mm from the step in the *foundation*.

(See Note A-9.23.13.9.(1).)

#### **9.23.13.10. Additional System Considerations**

1) This Article applies where

a) the seismic design parameter,  $S_{max}$ , is not greater than 1.2, and

b) the 1-in-50-year hourly wind pressure (HWP) is not greater than 1.2 kPa.

2) Portions of the perimeter of a single open or enclosed space need not comply with Sentence 9.23.13.5.(1), where

a) the roof of the space projects not more than

i) 3.5 m from the face of the framing of the nearest parallel *braced wall band*, and

ii) ~~half~~ the perpendicular plan dimension,

b) that portion of the perimeter structure does not support a floor,

c) the roof of the space is

i) integral with the roof of the rest of the building with framing members not more than 400 mm o.c. where roof sheathing edges are not supported on blocking and not more than 600 mm o.c. where roof sheathing edges are supported on blocking securely fastened between framing members, or

ii) constructed with roof framing not more than 400 mm o.c. where roof sheathing edges are not supported on blocking and not more than 600 mm o.c. where roof sheathing edges are supported on blocking securely fastened between framing members, and fastened to the wall framing (see Table 9.23.3.4. and Article 9.23.9.1. for balloon framing), and

d) the end-joists or end-rafters for the roof of the space are fastened to a 3-ply, 38 mm × 140 mm built-up column or a 5-ply, 38 mm × 89 mm built-up column that is integral with the wall framing.

(See Note A-9.23.13.10.(2).)

3) Walls in detached garages and in accessory *buildings* serving a single *dwelling unit*, and the front wall of attached garages serving a single *dwelling unit* need not comply with Sentence 9.23.13.5.(1) where these walls do not support a floor.

4) *Braced wall panels* in the *braced wall band* at the front of an attached garage serving a single *dwelling unit* need not comply with Sentence 9.23.13.5.(1), provided

a) the maximum spacing between the front of the garage and the back wall of the garage does not exceed 7.6 m,

b) there is not more than one floor above the garage,

c) not less than 50% of the length of the back wall of the garage is constructed of wood-sheathed *braced wall panels*, and

d) not less than 25% of the length of the side walls is constructed of wood-sheathed *braced wall panels*.

5) Except as provided in Sentences (6) and (7), one exterior wall of the uppermost *storey* in each orthogonal direction may be set back from the exterior wall of the *storey* below, provided the adjacent interior *braced wall band* of the *storey* below the setback

a) is spaced not more than 10.6 m from the exterior wall of the *storey* below the setback wall,

b) consists of *braced wall panels* that are constructed of a wood-based material in conformance with Sentence 9.23.13.6.(1),

c) extends to the *foundation*, and

d) is not taken into consideration when providing *braced wall panels* constructed of a wood-based material at spacing intervals of not more than 15 m as per Sentence 9.23.13.6.(3).

6) Where the exterior wall of the uppermost *storey* is set back from the exterior wall of the *storey* below, the roof and floor space supporting the setback wall shall be sheathed with a wood-based material between the exterior wall of the *storey* below the setback and the adjacent interior *braced wall bands* of the *storey* below the setback.

7) Where the exterior wall of the uppermost *storey* is set back from the exterior wall of the *storey* below, the exterior walls perpendicular to the setback wall shall

a) have their top plate connected with nails that are spaced at no greater than half the spacing required in Table 9.23.3.4., and

b) have their top plate splices fastened with twice the number of nails specified in Sentences 9.23.11.4.(5) and (6).

8) The maximum distance between adjacent required *braced wall panels* in a *braced wall band*, measured from the edge of the panels, may be increased to 7.3 m provided that, throughout the height of the *building*, the length of any *braced wall panel* within the *braced wall band* is not less than 1.2 m.

#### **9.23.13.11. Simplified Approach for Braced Wall Panel Length**

1) This Article applies to *buildings* where

a) the seismic design parameter,  $S_{max}$ , is not greater than 0.47,

b) the 1-in-50-year hourly wind pressure (HWP) is not greater than 0.60 kPa,

c) the specified roof snow load, as calculated in accordance with Article 9.4.2.2, is not greater than 2 kPa,

d) the plan dimensions of the *building* are each not greater than 21.2 m,



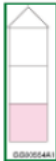
e) the building is located in rough terrain, as described in Note A-9.23.13.7.(3) and (4),

f) the greatest eave-to-ridge height of the roof is not greater than 3 m,

- g) the *braced wall panels* are constructed with gypsum board on at least one side,
  - h) the *braced wall bands* are continuously sheathed, and
  - h) the *building* is of normal-weight construction, as defined in Clause 9.23.13.2.(3)(a), except as provided in Sentence (4).
- 2) Except as provided in Sentence (3), the minimum total length of all *braced wall panels* in each direction shall be determined in accordance with
- a) Table 9.23.13.11-A where the seismic design parameter,  $S_{max}$ , is not greater than 0.3 and the 1-in-50-year hourly wind pressure (HWP) is not greater than 0.5 kPa, or
  - b) Table 9.23.13.11-B.

**Table 9.23.13.11.-A**

**Minimum Total Length of Braced Wall Panels where  $HWP \leq 0.5$  kPa and  $S_{max} \leq 0.3$   
Forming Part of Sentence 9.23.13.11.(2)**

Storey	Minimum Total Length Braced Wall Panels, m									
	Diagonal-Lumber-Sheathed Framing Type (with gypsum board on opposite side) <sup>(1)</sup>	Gypsum-Sheathed Framing Type (with gypsum board on only one side) <sup>(1)(2)</sup>				Wood-Sheathed Framing Type (with gypsum board on opposite side) <sup>(1)</sup>				
		DWB	GWB-A	GWB-B	GWB-C	GWB-D	WSP-A	WSP-B	WSP-C	WSP-D
	1.89	9.47 (4.74)	5.50 (2.75)	4.08 (2.04)	3.32 (1.66)	3.32	1.76	1.53	1.39	1.26
	3.89	19.45 (9.73)	11.30 (5.65)	8.38 (4.19)	6.82 (3.41)	6.82	3.61	3.14	2.86	2.59
	5.88	NP (14.71)	17.09 (8.55)	12.67 (6.34)	10.31 (5.16)	10.31	5.46	4.74	4.33	3.92

Notes to Table 9.23.13.11.-A:



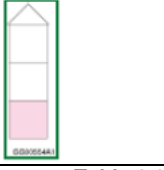
<sup>(1)</sup> See Sentence 9.23.3.5.(3) for a description of framing types and fastening requirements.

<sup>(2)</sup> NP = not permitted. Values within round brackets are permitted for *braced wall panels* with gypsum board installed on both sides.

**Table 9.23.13.11.-B**

**Minimum Total Length of Braced Wall Panels Where  $HWP \leq 0.6$  kPa and  $S_{max} \leq 0.47$   
Forming Part of Sentence 9.23.13.11.(2)**

Storey	Minimum Total Length Braced Wall Panels, m
--------	--

	Diagonal-Lumber-Sheathed Framing Type (with gypsum board on opposite side) <sup>(1)</sup>	Gypsum-Sheathed Framing Type (with gypsum board on only one side) <sup>(1)(2)</sup>				Wood-Sheathed Framing Type (with gypsum board on opposite side) <sup>(1)</sup>				
	DWB	GWB-A	GWB-B	GWB-C	GWB-D	WSP-A	WSP-B	WSP-C	WSP-D	WSP-E
	2.27	11.36 (5.68)	6.60 (3.30)	4.89 (2.45)	3.98 (1.99)	3.98	2.11	1.83	1.67	1.51
	4.66	NP (11.68)	13.56 (6.78)	10.06 (5.03)	8.18 (4.09)	8.18	4.34	3.76	3.44	3.11
	7.05	NP (17.96)	20.86 (10.43)	15.47 (7.74)	12.59 (6.30)	12.37	6.56	5.69	5.19	4.70

**Notes to Table 9.23.13.11.-B:**

(1) See Sentence 9.23.3.5.(3) for a description of framing types and fastening requirements.

(2) NP = not permitted. Values within round brackets are permitted for *braced wall panels* with gypsum board installed on both sides.

3) Except as provided in Sentence (4), the minimum total length of all *braced wall panels* in each *braced wall band* in the direction perpendicular to a single *building face* partially clad with masonry veneer shall be determined in accordance with

a) Table 9.23.13.11-C where the seismic design parameter,  $S_{max}$ , is not greater than 0.3 and the 1-in-50-year hourly wind pressure (HWP) is not greater than 0.50 kPa, or


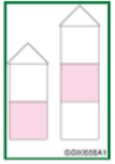
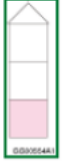
b) Table 9.23.13.11-D

**Table 9.23.13.11.-C**

**Minimum Total Length of Braced Wall Panels in a Braced Wall Band Perpendicular to a Building Face Partially Clad with Masonry Veneer where  $HWP \leq 0.5$  kPa and  $S_{max} \leq 0.3$**

**Forming Part of Sentence 9.23.13.11.(3)**

Storey	Minimum Total Length Braced Wall Panels, m									
	Diagonal-Lumber-Sheathed Framing Type (with gypsum board on opposite side) <sup>(1)</sup>	Gypsum-Sheathed Framing Type (with gypsum board on only one side) <sup>(1)(2)</sup>				Wood-Sheathed Framing Type (with gypsum board on opposite side) <sup>(1)</sup>				
	DWB	GWB-A	GWB-B	GWB-C	GWB-D	WSP-A	WSP-B	WSP-C	WSP-D	WSP-E

	1.89	9.47 (4.74)	5.50 (2.75)	4.08 (2.04)	3.25 (1.63)	3.32	1.76	1.53	1.39	1.26
	3.89	19.45 (9.73)	11.30 (5.65)	8.38 (4.19)	6.75 (3.37)	6.82	3.61	3.14	2.86	2.59
	5.88	NP (15.01)	17.44 (8.72)	12.93 (6.46)	10.49 (5.25)	10.31	5.46	4.74	4.33	3.92

**Notes to Table 9.23.13.11.-C:**


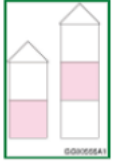
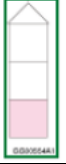
(1) See Sentence 9.23.3.5.(3) for a description of framing types and fastening requirements.

(2) NP = not permitted. Values within round brackets are permitted for *braced wall panels* with gypsum board installed on both sides.

**Table 9.23.13.11.-D**

**Minimum Total Length of Braced Wall Panels in a Braced Wall Band Perpendicular to a Building Face Partially Clad with Masonry Veneer where  $\leq 0.6$  kPa and  $S_{max} \leq 0.47$**

**Forming Part of Sentence 9.23.13.11.(3)**

Storey	Minimum Total Length Braced Wall Panels, m									
	Diagonal-Lumber-Sheathed Framing Type (with gypsum board on opposite side) <sup>(1)</sup>	Gypsum-Sheathed Framing Type (with gypsum board on only one side) <sup>(1)(2)</sup>				Wood-Sheathed Framing Type (with gypsum board on opposite side) <sup>(1)</sup>				
		DWB	GWB-A	GWB-B	GWB-C	GWB-D	WSP-A	WSP-B	WSP-C	WSP-D
	2.27	13.12 (6.56)	7.63 (3.81)	5.66 (2.83)	4.89 (2.44)	3.98	2.11	1.83	1.67	1.51
	4.66	NP (15.14)	17.59 (8.79)	13.04 (6.52)	10.57 (5.28)	8.18	4.34	3.76	3.44	3.11
	7.05	NP (NP)	NP (13.66)	20.27 (10.13)	16.49 (8.24)	12.37	6.56	5.69	5.19	4.70

**Notes to Table 9.23.13.11.-D:**

(1) See Sentence 9.23.3.5.(3) for a description of framing types and fastening requirements.

<sup>(2)</sup> NP = not permitted. Values within round brackets are permitted for *braced wall panels* with gypsum board installed on both sides.

4) Wall portions clad with masonry veneer that are located both perpendicular to a *braced wall band* and within a *braced wall band* are permitted to be considered as normal-weight construction.

5) Bracing to resist lateral loads shall be designed and constructed in accordance with Articles 9.23.13.4 to 9.23.13.6 and 9.23.13.8 to 9.23.13.10.

## **9.23.14. Roof and Ceiling Framing**

### **9.23.14.1. Continuity of Rafters and Joists**

1) Roof rafters and joists and ceiling joists shall be continuous or shall be spliced over vertical supports that extend to suitable bearing.

### **9.23.14.2. Framing around Openings**

1) Roof and ceiling framing members shall be doubled on each side of openings greater than 2 rafter or joist spacings wide.

### **9.23.14.3. End Bearing Length**

1) The length of end bearing of joists and rafters shall be not less than 38 mm.

### **9.23.14.4. Location and Attachment of Rafters**

1) Rafters shall be located directly opposite each other and tied together at the peak, or may be offset by their own thickness if nailed to a ridge board not less than 17.5 mm thick.

2) Except as permitted in Sentence (3), framing members shall be connected by gusset plates or nailing at the peak in conformance with Table 9.23.3.4.

3) Where the roof framing on opposite sides of the peak is assembled separately, such as in the case of factory-built houses, the roof framing on opposite sides is permitted to be fastened together with galvanized-steel strips not less than 200 mm by 75 mm by 0.41 mm thick spaced not more than 1.2 m apart and nailed at each end to the framing by at least two 63 mm nails.

### **9.23.14.5. Shaping of Rafters**

1) Rafters shall be shaped at supports to provide even bearing surfaces and supported directly above the exterior walls.

### **9.23.14.6. Hip and Valley Rafters**

1) Hip and valley rafters shall be not less than 50 mm greater in depth than the common rafters and not less than 38 mm thick, actual dimension.

### **9.23.14.7. Intermediate Support for Rafters and Joists**

1) Ceiling joists and collar ties of not less than 38 mm by 89 mm lumber are permitted to be assumed to provide intermediate support to reduce the span for rafters and joists where the roof slope is 1 in 3 or greater.

2) Collar ties referred to in Sentence (1) more than 2.4 m long shall be laterally supported near their centres by not less than 19 mm by 89 mm continuous members at right angles to the collar ties.

3) Dwarf walls and struts are permitted to be used to provide intermediate support to reduce the span for rafters and joists.

4) When struts are used to provide intermediate support they shall be not less than 38 mm by 89 mm material extending from each rafter to a *loadbearing* wall at an angle of not less than 45° to the horizontal.

5) When dwarf walls are used for rafter support, they shall be framed in the same manner as *loadbearing* walls and securely fastened top and bottom to the roof and ceiling framing to prevent over-all movement.

6) Solid blocking shall be installed between floor joists beneath dwarf walls referred to in Sentence (5) that enclose finished rooms.

**9.23.14.8. Ridge Support**

1) Except as provided in Sentence (4), roof rafters and joists shall be supported at the ridge of the roof by

- a) a *loadbearing* wall extending from the ridge to suitable bearing, or
- b) a ridge beam supported by not less than 89 mm length of bearing.

2) Except as provided in Sentence (3), the ridge beam referred to in Sentence (1) shall conform to the sizes and spans shown in Span Table 9.23.4.2.-L, provided

- a) the supported rafter or joist length does not exceed 4.9 m, and
- b) the roof does not support any concentrated loads.

3) The ridge beam referred to in Sentence (1) need not comply with Sentence (2) where

- a) the beam is of not less than 38 mm by 140 mm material, and
- b) the beam is supported at intervals not exceeding 1.2 m by not less than 38 mm by 89 mm members extending vertically from the ridge to suitable bearing.

4) Where the roof slope is 1 in 3 or steeper, ridge support need not be provided when the lower ends of the rafters are adequately tied to prevent outward movement.

5) Ties required in Sentence (4) are permitted to consist of tie rods or ceiling joists forming a continuous tie for opposing rafters and nailed in accordance with Table 9.23.14.8.

**Table 9.23.14.8.**

**Rafter-to-Joist Nailing (Unsupported Ridge)  
Forming Part of Sentences 9.23.14.8.(5) and (8)**

Roof Slope	Rafter Spacing, mm	Minimum Number of Nails Not Less Than 76 mm Long and 3.66 mm in Diameter <sup>(1)(2)(3)(4)</sup>											
		Building Width up to 4 m			Building Width up to 6 m			Building Width up to 8 m			Building Width up to 10 m		
		Specified Roof Snow Load, kPa			Specified Roof Snow Load, kPa			Specified Roof Snow Load, kPa			Specified Roof Snow Load, kPa		
		1.0	1.5	2.0	1.0	1.5	2.0	1.0	1.5	2.0	1.0	1.5	2.0
1 in 3	300	3	4	5	5	6	7	6	8	10	7	10	(5)
	400	4	5	7	6	8	10	8	10	(5)	10	(5)	(5)
	600	6	8	10	9	(5)	(5)	(5)	(5)	(5)	(5)	(5)	(5)
1 in 2.4	300	3	3	4	4	5	6	5	6	8	6	8	10
	400	3	4	5	5	6	8	6	8	10	8	10	(5)
	600	5	6	8	7	9	(5)	9	(5)	(5)	(5)	(5)	(5)



1 in 2	300	2	3	4	3	4	5	4	5	7	5	7	8
	400	3	4	5	4	5	7	5	7	9	7	9	<sup>(5)</sup>
	600	4	5	7	6	8	10	8	10	<sup>(5)</sup>	10	<sup>(5)</sup>	<sup>(5)</sup>
1 in 1.71	300	2	3	3	3	4	4	4	5	6	4	6	7
	400	3	3	4	4	5	6	5	6	8	6	7	9
	600	4	5	6	5	7	8	7	9	<sup>(5)</sup>	8	<sup>(5)</sup>	<sup>(5)</sup>
1 in 1.5	300	2	2	3	3	3	4	3	4	5	4	5	6
	400	2	3	4	3	4	5	4	5	7	5	7	8
	600	3	4	5	5	6	7	6	8	10	7	10	<sup>(5)</sup>
1 in 1.33	300	2	2	3	2	3	4	3	4	5	4	5	6
	400	2	3	3	3	4	5	4	5	6	5	6	7
	600	3	4	5	4	5	7	5	7	9	7	9	<sup>(5)</sup>
1 in 1.2	300	2	2	2	2	3	3	3	3	4	3	4	5
	400	2	2	3	3	3	4	3	4	5	4	5	7
	600	3	3	4	4	5	6	5	6	8	6	8	10
1 in 1	300	2	2	2	2	2	3	2	3	4	3	4	4
	400	2	2	3	2	3	4	3	4	5	4	5	6
	600	2	3	4	3	4	5	4	5	7	5	7	8

**Notes to Table 9.23.14.8.:**

<sup>(1)</sup> Nails with a diameter less than 3.66 mm are permitted to be used, provided the minimum number of nails stated in the Table is modified as follows:

- For a nail diameter greater than or equal to 2.86 mm and less than 3.25 mm, add 3 nails to the minimum number of nails, up to a maximum of 10 nails.
- For a nail diameter greater than or equal to 3.25 mm and less than 3.66 mm, add 2 nails to the minimum number of nails, up to a maximum of 10 nails.

Where more than 10 nails are required, the connections between the rafters and the ceiling joists shall be designed in accordance with Clause 9.4.1.1.(1)(b) or (c).

<sup>(2)</sup> The minimum number of nails stated in the Table is applicable to Spruce-Pine-Fir, Douglas Fir-Larch and Hem-Fir members. For Northern Species members, add 2 nails to the minimum number of nails, up to a maximum of 10 nails. Where more than 10 nails are required, the connections between the rafters and the ceiling joists shall be designed in accordance with Clause 9.4.1.1.(1)(b) or (c).

<sup>(3)</sup> To accommodate nail spacing, not less than 38 mm x 140 mm joists shall be used where 6 or more nails are required, and not less than 38 mm x 184 mm joists shall be used where 8 or more nails are required.

<sup>(4)</sup> The minimum number of nails in the Table is applicable for a maximum roof *dead load* of 0.5 kPa.

<sup>(5)</sup> The connections between the rafters and the ceiling joists shall be designed in accordance with Clause 9.4.1.1.(1)(b) or (c).

6) Except as permitted in Sentence (7), ceiling joists referred to in Sentence (5) shall be tied to the base of every rafter.

7) Where ceiling joists referred to in Sentence (5) are raised above the base of the rafters, the connections between the rafters and the ceiling joists shall be designed in accordance with Clause 9.4.1.1.(1)(b) or (c).

8) Ceiling joists referred to in Sentence (5) that are spliced to make a continuous joist shall be fastened together at each splice with at least one more nail than required for the rafter-to-joist connection shown in Table 9.23.14.8.

9) Members referred to in Sentences (6) and (8) are permitted to be fastened together either directly or through a gusset plate.

#### **9.23.14.9. Restraint of Joist Bottoms**

1) Roof joists supporting a finished ceiling, other than plywood, OSB or waferboard, shall be restrained from twisting along the bottom edges by means of furring, blocking, cross bridging or strapping conforming to Article 9.23.9.3.

#### **9.23.14.10. Ceiling Joists Supporting Roof Load**

1) Except as permitted in Sentence (2), ceiling joists supporting part of the roof load from the rafters shall be not less than 25 mm greater in depth than required for ceiling joists not supporting part of the roof load.

2) When the roof slope is 1 in 4 or less, the ceiling joist sizes referred to in Sentence (1) shall be determined from Span Tables 9.23.4.2.-C to 9.23.4.2.-F and 9.23.4.2.-L for roof joists.

#### **9.23.14.11. Roof Trusses**

1) Wood roof trusses shall be designed in accordance with good engineering practice such as that described in TPIC 2019, "Truss Design Procedures and Specifications for Light Metal Plate Connected Wood Trusses."

2) The joint connections used in trusses described in Sentence (1) shall be designed in conformance with the requirements in Subsection 4.3.1. (See Note A-9.23.14.11.(2).)

3) All member bracing shall be installed as per the truss design drawings, and continuous lateral bracing shall be adequately anchored to the roof and ceiling diaphragms at intervals no greater than 6.10 m o.c.

### **9.23.15. Subflooring**

#### **9.23.15.1. Subflooring Required**

1) Subflooring shall be provided beneath finish flooring where the finish flooring does not have adequate strength to support the specified *live loads* (see Subsection 9.30.3.).

#### **9.23.15.2. Material Standards**

1) Except as provided in Sentence (2), wood-based panels for subfloors shall conform to

- a) CSA O121, "Douglas fir plywood,"
- b) CSA O151, "Canadian softwood plywood,"
- c) CSA O153, "Poplar plywood,"
- d) CSA O325, "Construction sheathing," or
- e) CSA O437.0, "OSB and Waferboard."

2) Particleboard subflooring may be used only where a *building* is constructed in a factory so that the subfloor will not be exposed to the weather.

3) Subflooring described in Sentence (2) shall conform to grade D-2 or D-3 in ANSI A208.1, "Particleboard."

4) Subflooring described in Sentence (2) shall have its upper surface and all edges treated to restrict water absorption, where the subfloor is used in bathrooms, kitchens, laundry rooms or other areas subject to periodic wetting. (See Note A-9.23.15.2.(4).)

#### **9.23.15.3. Edge Support**

1) Where the edges of panel-type subflooring are required to be supported (see Sentence 9.30.2.1.(2)), such support shall consist of tongue-and-groove panel edges or not less than 38 mm by 38 mm blocking securely nailed between framing members.

**9.23.15.4. Direction of Installation**

1) Plywood subflooring shall be installed with the surface grain at right angles to the joists and with joints parallel to floor joists staggered.

2) OSB subflooring conforming to CSA O325, "Construction sheathing," or to O-1 and O-2 grades in CSA O437.0, "OSB and Waferboard," and waferboard subflooring conforming to R-1 grade in CSA O437.0 shall be installed so that the direction of face orientation is at right angles to the joists and the joints parallel to the floor joists are staggered. (See Note A-9.23.15.4.(2).)

**9.23.15.5. Subfloor Thickness or Rating**

1) Except as provided in Sentences (2) and (3), subfloors shall conform to either Table 9.23.15.5.-A or 9.23.15.5.-B.

**Table 9.23.15.5.-A  
Thickness of Subflooring**

**Forming Part of Sentences 9.23.15.5.(1) and 9.23.16.7.(1)**

Maximum Spacing of Supports, mm	Minimum Thickness, mm			
	Plywood and OSB, O-2 Grade	OSB, O-1 Grade, and Waferboard, R-1 Grade	Particleboard	Lumber
400	15.5	15.9	15.9	17.0
500	15.5	15.9	19.0	19.0
600	18.5	19.0	25.4	19.0

**Table 9.23.15.5.-B**

**Rating for Subfloor when Applying CSA O325**

**Forming Part of Sentences 9.23.15.5.(1) and 9.23.16.7.(1)**

Maximum Spacing of Supports, mm	Panel Mark	
	Subfloor	Used with Panel-Type Underlay
400	1F16	2F16
500	1F20	2F20
600	1F24	2F24

2) Where the finished flooring consists of not less than 19 mm matched wood strip flooring laid at right angles to joists spaced not more than 600 mm o.c., subflooring shall be permitted to consist of not less than

- a) 12.5 mm thick plywood,
- b) 12.5 mm thick OSB conforming to O-2 grade,
- c) 12.7 mm thick OSB conforming to O-1 grade,
- d) 12.7 mm thick waferboard conforming to R-1 grade, or
- e) OSB conforming to 2R32/2F16 grade.

3) Except where the flooring consists of ceramic tiles applied with adhesive, where a separate panel-type underlay or concrete topping is applied to a subfloor on joists spaced not more than 400 mm o.c., the subfloor is permitted to consist of not less than

- a) 12.5 mm thick plywood,
- b) 12.5 mm thick OSB conforming to O-2 grade,
- c) 12.7 mm thick OSB conforming to O-1 grade,
- d) 12.7 mm thick waferboard conforming to R-1 grade, or
- e) OSB conforming to 2R32/2F16 grade.

#### **9.23.15.6. Annular Grooved Nails**

1) When resilient flooring is applied directly to an OSB, waferboard, particleboard or plywood subfloor, the subfloor shall be fastened to the supports with annular grooved nails.

#### **9.23.15.7. Lumber Subflooring**

- 1) Lumber subflooring shall be laid at an angle of not less than 45° to the joists.
- 2) Lumber subflooring shall be fully supported at the ends on solid bearing.
- 3) Lumber for subflooring shall be of uniform thickness and not more than 184 mm wide.

### **9.23.16. Roof Sheathing**

#### **9.23.16.1. Required Roof Sheathing**

1) Except where the 1-in-50-year hourly wind pressure (HWP) is less than 0.8 kPa and the seismic design parameter,  $S_{max}$ , for Site Class C, is less than or equal to 0.47, continuous lumber or panel-type roof sheathing shall be installed to support the roofing.

#### **9.23.16.2. Material Standards**

- 1) Wood-based panels used for roof sheathing shall conform to the requirements of
  - a) CSA O121, "Douglas fir plywood,"
  - b) CSA O151, "Canadian softwood plywood,"
  - c) CSA O153, "Poplar plywood,"
  - d) CSA O325, "Construction sheathing," or
  - e) CSA O437.0, "OSB and Waferboard."

#### **9.23.16.3. Direction of Installation**

1) Plywood roof sheathing shall be installed with the surface grain at right angles to the roof framing.

2) OSB roof sheathing conforming to CSA O325, "Construction sheathing," or to O-1 and O-2 grades as specified in CSA O437.0, "OSB and Waferboard," shall be installed with the direction of face orientation at right angles to the roof framing members. (See Note A-9.23.15.4.(2).)

#### **9.23.16.4. Joints in Panel-Type Sheathing**

1) Panel-type sheathing board shall be applied so that joints perpendicular to the roof ridge are staggered where

- a) the sheathing is applied with the surface grain parallel to the roof ridge, and
- b) the thickness of the sheathing is such that the edges are required to be supported.

2) A gap of not less than 2 mm shall be left between sheets of plywood, OSB or waferboard.

**9.23.16.5. Lumber Roof Sheathing**

1) Lumber roof sheathing shall not be more than 286 mm wide and shall be applied so that all ends are supported with end joints staggered.

2) Lumber roof sheathing shall be installed diagonally, where

a) the seismic design parameter,  $S_{max}$ , Site Class C is greater than 0.47 but not greater than 0.8, or

b) the 1-in-50-year hourly wind pressure (HWP) is equal to or greater than 0.80 kPa but less than 1.2 kPa.

3) Lumber roof sheathing shall be designed according to Part 4, where

a) the seismic design parameter,  $S_{max}$ , for Site Class C is greater than 0.8, or

b) the 1-in-50-year hourly wind pressure (HWP) is equal to or greater than 1.2 kPa.

**9.23.16.6. Edge Support**

1) Where panel-type roof sheathing requires edge support, the support shall consist of metal H clips or not less than 38 mm by 38 mm blocking securely nailed between framing members.

**9.23.16.7. Thickness or Rating**

1) The thickness or rating of roof sheathing on a flat roof used as a walking deck shall conform to either Table 9.23.15.5.-A or 9.23.15.5.-B for subfloors.

2) The thickness or rating of roof sheathing on a roof not used as a walking deck shall conform to either Table 9.23.16.7.-A or 9.23.16.7.-B.

3) Asphalt-coated or asphalt-impregnated fibreboard not less than 11.1 mm thick conforming to CAN/ULC-S706.1, "Standard for Wood Fibre Insulating Boards for Buildings," is permitted to be used as a roof sheathing over supports spaced not more than 400 mm o.c. provided the roofing consists of

a) a continuous sheet of galvanized steel not less than 0.33 mm in thickness, or

b) a continuous sheet of aluminum not less than 0.61 mm in thickness.

4) All edges of sheathing described in Sentence (3) shall be supported by blocking or framing.

**Table 9.23.16.7.-A  
Thickness of Roof Sheathing  
Forming Part of Sentence 9.23.16.7.(2)**

Maximum Spacing of Supports, mm	Minimum Thickness, mm				
	Plywood, and OSB, O-2 Grade		OSB, O-1 Grade, and Waferboard, R-1 Grade		Lumber
	Edges Supported	Edges Unsupported	Edges Supported	Edges Unsupported	
300	7.5	7.5	9.5	9.5	17.0
400	7.5	9.5	9.5	11.1	17.0
600	9.5	12.5	11.1	12.7	19.0

Table 9.23.16.7.-B

Rating for Roof Sheathing When Applying CSA O325

**Forming Part of Sentence 9.23.16.7.(2)**

Maximum Spacing of Supports, mm	Panel Mark	
	Edges Supported	Edges Unsupported
400	2R16	1R16
500	2R20	1R20
600	2R24	1R24

**9.23.17. Wall Sheathing****9.23.17.1. Required Sheathing**

1) Exterior walls and gable ends shall be sheathed when the exterior cladding requires intermediate fastening between supports or if the exterior cladding requires solid backing.

**9.23.17.2. Thickness, Rating and Material Standards**

1) Where wall sheathing is required for the purpose of complying with this Section, it shall conform to either Table 9.23.17.2.-A or 9.23.17.2.-B. (See also Article 9.25.5.1.)

**Table 9.23.17.2.-A****Wall Sheathing Thickness and Specifications****Forming Part of Sentence 9.23.17.2.(1)**

Type of Sheathing	Minimum Thickness, mm <sup>(1)</sup>		Material Standards
	With Supports 400 mm o.c.	With Supports 600 mm o.c.	
Fibreboard (insulating)	9.5	11.1	CAN/ULC-S706.1
Gypsum sheathing	9.5	12.7	ASTM C1177/C1177M ASTM C1396/C1396M <sup>(2)</sup>
Lumber	17.0	17.0	See Table 9.3.2.1.
Mineral Fibre, Rigid Board, Type 2	25	25	CAN/ULC-S702.1
OSB, O-2 Grade	6.0	7.5	CSA O437.0
OSB, O-1 Grade, and Waferboard, R-1 Grade	6.35	7.9	CSA O437.0
Phenolic, faced	25	25	CAN/CGSB-51.25-M
Plywood (exterior type)	6.0	7.5	CSA O121 CSA O151 CSA O153
Polystyrene, Types 1 and 2	38	38	CAN/ULC-S701.1
Polystyrene, Types 3 and 4	25	25	CAN/ULC-S701.1
Polyurethane and Polyisocyanurate Type 1, faced	38	38	CAN/ULC-S704.1
Polyurethane and Polyisocyanurate Types 2 and 3, faced	25	25	CAN/ULC-S704.1

**Notes to Table 9.23.17.2.-A:**

<sup>(1)</sup> See also Sentences 9.27.5.1.(2) to (4).

<sup>(2)</sup> The *flame-spread rating* of gypsum board shall be determined in accordance with CAN/ULC-S102, "Standard Method of Test for Surface Burning Characteristics of Building Materials and Assemblies."

**Table 9.23.17.2.-B**

**Rating for Wall Sheathing when Applying CSA O325**

**Forming Part of Sentence 9.23.17.2.(1)**

Maximum Spacing of Supports, mm	Panel Mark
400	W16
500	W20
600	W24

**9.23.17.3. Attachment of Cladding to Sheathing**

1) Gypsum sheathing, rigid insulation and fibreboard shall not be used for the attachment of cladding materials.

**9.23.17.4. Lumber Sheathing**

1) Lumber wall sheathing shall be applied so that all ends are supported.

2) Where lumber wall sheathing is required to provide bracing according to Article 9.23.10.2., it shall be applied with end joints staggered.

**9.23.17.5. Joints in Panel-Type Sheathing**

1) A gap of not less than 2 mm shall be left between sheets of plywood, OSB, waferboard or fibreboard.

**9.23.17.6. Mansard Style Roofs**

1) Where the bottom portions of mansard style roofs are vented, the vertical framing members behind the sloping portions shall be considered on the same basis as exterior wall studs and shall conform to Articles 9.27.3.2. to 9.27.3.6.

## **Section 9.24. Sheet Steel Stud Wall Framing**

### **9.24.1. General**

#### **9.24.1.1. Application**

1) This Section applies to sheet steel studs for use in non-*loadbearing* exterior and interior walls.

2) Where *loadbearing* steel studs are used, they shall be designed in conformance with Part 4.

#### **9.24.1.2. Material Standards**

1) Steel studs and runners shall conform to AISI S201, "North American Standard for Cold-Formed Steel Framing - Product Data 2012 Edition."

#### **9.24.1.3. Metal Thickness**

1) Metal thickness specified in this Section shall be the minimum base steel thickness exclusive of coatings.

#### **9.24.1.4. Screws**

1) Screws for the application of cladding, sheathing or interior finish materials to steel studs, runners and furring channels shall conform to

a) ASTM C954, "Standard Specification for Steel Drill Screws for the Application of Gypsum Panel Products or Metal Plaster Bases to Steel Studs from 0.033 in. (0.84 mm) to 0.112 in. (2.84 mm) in Thickness," or

b) ASTM C1002, "Standard Specification for Steel Self-Piercing Tapping Screws for the Application of Gypsum Panel Products or Metal Plaster Bases to Wood Studs or Steel Studs."

**9.24.1.5. Cladding, Sheathing and Interior Finish Required**

1) Cladding or sheathing, and interior finish shall be installed on steel stud framing and shall be fastened with screws

a) spaced at the appropriate spacing described in Section 9.29., and

b) penetrating not less than 10 mm through the metal.

**9.24.2. Size of Framing**

**9.24.2.1. Size and Spacing of Studs in Interior Walls**

1) Except as required in Articles 9.24.2.3. and 9.24.2.4., the size and spacing of steel studs for non-loadbearing interior walls shall conform to Table 9.24.2.1.

**Table 9.24.2.1.**

**Steel Studs for Non-Loadbearing Interior Walls(1)**

**Forming Part of Sentence 9.24.2.1.(1)**

Minimum Stud Size, mm	Maximum Stud Spacing, mm	Maximum Wall Height, m
32 x 41	400	3.0
	600	2.7
32 x 64	300	4.4
	400	4.0
	600	3.5
32 x 89	300	5.2
	400	4.6
	600	3.9
32 x 152	300	6.6
	400	5.8
	600	4.9

**Notes to Table 9.24.2.1.:**

<sup>(1)</sup> The values in the Table are based on a single layer of 12.7 mm gypsum panel sheathing installed on each side of the studs. Where one side is not accessible, gypsum panels on only one side will suffice. The values are also based on attaching gypsum panel sheathing using screws not smaller than No. 6 spaced at a maximum of 300 mm at edges and at intermediate supports.

**9.24.2.2. Thickness of Studs**

1) Except as required in Article 9.24.2.4., steel studs in non-loadbearing interior walls shall have a metal thickness of not less than 0.46 mm.

**9.24.2.3. Runners**



1) Runners for interior and exterior non-loadbearing walls shall have a thickness not less than the thickness of the corresponding studs and shall have not less than 30 mm flanges.

**9.24.2.4. Openings in Fire Separations**

1) Where openings for doors in non-loadbearing fire separations required to have a fire-resistance rating do not exceed 1 200 mm in width,

- a) the width of steel studs shall be not less than 63 mm, and
- b) the metal thickness shall be not less than 0.46 mm.

2) Where openings described in Sentence (1) exceed 1 200 mm in width,

- a) the width of steel studs shall be not less than 91 mm, and
- b) the metal thickness shall be not less than 0.85 mm.

3) The distance to the first stud beyond the jamb of any door opening in a fire separation required to have a fire-resistance rating shall not exceed 400 mm.

4) Where the distance between the framing over the opening referred to in Sentence (3) and the top runner exceeds 400 mm in such walls, intermediate support shall be installed at intervals of not more than 400 mm above the opening.

**9.24.2.5. Size and Spacing of Studs in Exterior Walls**

1) The size and spacing of non-loadbearing steel studs for exterior walls shall conform to Table 9.24.2.5.

Table 9.24.2.5.

Size and Spacing of Steel Studs for Non-Loadbearing Exterior Walls

**Forming Part of Sentence 9.24.2.5.(1)**

Minimum Stud Size, mm	Minimum Metal Thickness, mm	Maximum Stud Length, m		
		Spacing of Studs		
		300 mm o.c.	400 mm o.c.	600 mm o.c.
30 × 91	0.53	3.0	2.4	—
30 × 91	0.69	3.3	2.7	2.4
30 × 91	0.85	3.6	3.0	2.7
30 × 91	1.0	4.0	3.3	3.0

**9.24.3. Installation**

**9.24.3.1. Installation of Runners**

1) Runners shall be provided at the tops and bottoms of walls.

2) Runners required in Sentence (1) shall be securely attached to the building at approximately 50 mm from the ends, and at intervals of not more than 600 mm o.c. for interior walls and 300 mm o.c. for exterior walls.

3) Fasteners used for attachment described in Sentence (2) shall consist of the equivalent of 63 mm nails or 25 mm screws.

4) Studs at openings and which are not full wall height shall be supported by a runner at the ends of the studs, securely fastened to the full length studs at the sides of the opening.

### **9.24.3.2. Fire-Rated Walls**

- 1) Steel studs used in walls required to have a *fire-resistance rating* shall be installed so that there is not less than a 12 mm clearance between the top of the stud and the top of the runner to allow for expansion in the event of fire.
- 2) Except as provided in Article 9.24.3.6., studs in walls referred to in Sentence (1) shall not be attached to the runners in a manner that will prevent such expansion.
- 3) Framing above doors with steel door frames in *non-loadbearing fire separations* required to have a *fire-resistance rating* shall consist of 2 runners on the flat fastened back to back. (See Note A-9.24.3.2.(3).)
- 4) The upper runner required in Sentence (3) shall be bent at each end to extend upwards not less than 150 mm and fastened to the adjacent studs.
- 5) A gypsum board filler piece, the width and length of the runner, shall be provided between the door frame referred to in Sentence (3) and the adjacent runner.

### **9.24.3.3. Orientation of Studs**

- 1) Steel studs shall be installed with webs at right angles to the wall face and, except at openings, shall be continuous for the full wall height.

### **9.24.3.4. Support for Cladding Materials**

- 1) Corners and intersections of walls shall be constructed to provide support for the cladding materials.

### **9.24.3.5. Framing around Openings**

- 1) Studs shall be doubled on each side of every opening where such openings involve more than one stud space, and shall be tripled where the openings in exterior walls exceed 2.4 m in width.
- 2) Studs described in Sentence (1) shall be fastened together by screws, crimping or welding to act as a single structural unit in resisting transverse loads.

### **9.24.3.6. Attachment of Studs to Runners**

- 1) Studs shall be attached to runners by screws, crimping or welding around wall openings and elsewhere where necessary to keep the studs in alignment during construction.
- 2) Where clearance for expansion is required in Article 9.24.3.2., attachment required in Sentence (1) shall be applied between studs and bottom runners only.

### **9.24.3.7. Openings for Fire Dampers**

- 1) Openings for *fire dampers* in *non-loadbearing fire separations* required to have a *fire-resistance rating* shall be framed with double studs on each side of the opening.
- 2) The sill and header for openings described in Sentence (1) shall consist of a runner track with right angle bends made on each end so as to extend 300 mm above the header or below the sill and fastened to the studs.
- 3) The openings described in Sentence (1) shall be lined with a layer of gypsum board not less than 12.7 mm thick fastened to stud and runner webs.

## **Section 9.25. Heat Transfer, Air Leakage and Condensation Control**

## **9.25.1. General**

### **9.25.1.1. Scope and Application**

1) This Section is concerned with heat, air and water vapour transfer and measures to control condensation.

(See Sentence 1.3.3.2. (3) of Division A for Part 5 application to Group C multi-family residential occupancies and artist live/work studios.)

2) All walls, ceilings and floors separating *conditioned space* from unconditioned space, the exterior air or the ground shall be

a) provided with

i) thermal insulation conforming to Subsection 9.25.2. and Part 10,

ii) an air barrier conforming to Subsection 9.25.3. and Part 10, and

iii) a *vapour barrier* conforming to Subsection 9.25.4., and

b) constructed in such a way that the properties and relative position of all materials conform to Subsection 9.25.5.

(See Note A-9.25.1.1.(2).)

3) Insulation and sealing of heating and ventilating ducts shall conform to Sections 9.32. and 9.33., and Part 10.

4) Except for buildings containing only dwelling units or for portions of buildings containing dwelling units, the design and installation of thermal insulation and measures to control heat transfer and condensation shall conform to Part 10.

## **9.25.2. Thermal Insulation**

### **9.25.2.1. Required Insulation**

1) All walls, ceilings and floors separating heated space from unheated space, the exterior air or the exterior *soil* shall be provided with sufficient thermal insulation to prevent moisture condensation on their room side during the winter and to ensure comfortable conditions for the occupants. (See Note A-9.1.1.1.(1).)

### **9.25.2.2. Insulation Materials**

1) Except as required in Sentence (2), thermal insulation shall conform to the requirements of

a) ASTM C726, "Standard Specification for Mineral Wool Roof Insulation Board,"

b) CAN/CGSB-51.25-M, "Thermal Insulation, Phenolic, Faced,"

c) CGSB 51-GP-27M, "Thermal Insulation, Polystyrene, Loose Fill,"

d) CAN/ULC-S701.1, "Standard for Thermal Insulation, Polystyrene Boards,"

e) CAN/ULC-S702.1, "Standard for Mineral Fibre Thermal Insulation for Buildings, Part 1: Material Specification,"

f) CAN/ULC-S703, "Standard for Cellulose Fibre Insulation (CFI) for Buildings,"

g) CAN/ULC-S704.1, "Standard for Thermal Insulation, Polyurethane and Polyisocyanurate, Boards, Faced,"

- h) CAN/ULC-S705.1, "Standard for Thermal Insulation – Spray Applied Rigid Polyurethane Foam, Medium Density – Material Specification," or
  - i) CAN/ULC-S706.1, "Standard for Wood Fibre Insulating Boards for Buildings."
- 2) The *flame-spread ratings* requirements contained in the standards listed in Sentence (1) shall not apply. (See Note A-9.25.2.2.(2).)
- 3) Insulation in contact with the ground shall be inert to the action of *soil* and water and shall be such that its insulative properties are not significantly reduced by moisture.

#### **9.25.2.3. Installation of Thermal Insulation**

- 1) Insulation shall be installed so that there is a reasonably uniform insulating value over the entire face of the insulated area.
- 2) Insulation shall be applied to the full width and length of the space between furring or framing.
- 3) Except where the insulation provides the principal resistance to air leakage, thermal insulation shall be installed so that at least one face is in full and continuous contact with an element with low air permeance. (See Note A-9.25.2.3.(3).)
- 4) Insulation shall be installed over the full height of *foundation* walls enclosing a *basement* or heated crawl space. (See also Part 10.)
- 5) Insulation around concrete slabs-on-ground shall be located so that heat from the *building* is not restricted from reaching the ground beneath the perimeter, where exterior walls are not supported by footings extending below frost level.
- 6) Where insulation is exposed to the weather and subject to mechanical damage, it shall be protected with not less than
- a) 6 mm preservative-treated plywood, or
  - b) 12 mm cement parging on wire lath applied to the exposed face and edge.
- 7) Insulation located in areas where it may be subject to mechanical damage shall be protected by a covering such as gypsum board, plywood, particleboard, OSB, waferboard or hardboard.
- 8) Insulation in factory-built *buildings* shall be installed so that it will not become dislodged during transportation.

#### **9.25.2.4. Installation of Loose-Fill Insulation**

- 1) Except as provided in Sentences (2) to (6), loose-fill insulation shall be used on horizontal surfaces only.
- 2) Where loose-fill insulation is installed in an unconfined sloped space, such as an attic space over a sloped ceiling, the supporting slope shall not be more than
- a) 4.5 in 12 for mineral fibre or cellulose fibre insulation, and
  - b) 2.5 in 12 for other types of insulation.
- 3) Loose-fill insulation is permitted to be used in wood-frame walls of existing *buildings*. (See Note A-9.25.2.4.(3).)
- 4) Where blown-in insulation is installed in above-ground or below-ground wood-frame walls of new *buildings*,
- a) the density of the installed insulation shall be sufficient to preclude settlement,

- b) the insulation shall be installed behind a membrane that will permit visual inspection prior to the installation of the interior finish,
  - c) the insulation shall be installed in a manner that will not interfere with the installation of the interior finish, and
  - d) no water shall be added to the insulation, unless it can be shown that the added water will not adversely affect other materials in the assembly.
- 5) Water repellent loose-fill insulation is permitted to be used between the outer and inner wythes of masonry *cavity walls*. (See Note A-9.25.2.4.(5).)
- 6) Where soffit venting is used, measures shall be taken
    - a) to prevent loose-fill insulation from blocking the soffit vents and to maintain an open path for circulation of air from the vents into the *attic or roof space*, and
    - b) to minimize airflow into the insulation near the soffit vents to maintain the thermal performance of the material. (See Article 9.19.1.3.)

#### **9.25.2.5. Installation of Spray-Applied Polyurethane**

1) Spray-applied polyurethane insulation shall be installed in accordance with CAN/ULC-S705.2, "Standard for Thermal Insulation – Spray Applied Rigid Polyurethane Foam, Medium Density – Application."

### **9.25.3. Air Barrier Systems**

#### **9.25.3.1. Required Barrier to Air Leakage**

- 1) Wall, ceiling and floor assemblies separating *conditioned space* from unconditioned space or from the ground shall be constructed so as to include an *air barrier system* that will provide a continuous barrier to air leakage
- a) from the interior of the *building* into wall, floor, *attic or roof spaces*, sufficient to prevent excessive moisture condensation in such spaces during the winter, and
  - b) from the exterior or the ground inward sufficient to
    - i) prevent moisture condensation on the room side during winter,
    - ii) ensure comfortable conditions for the occupants, and
    - iii) minimize the ingress of *soil gas*.

(See Note A-9.25.3.1.(1).)

#### **9.25.3.2. Air Barrier System Properties**

(See Note A-9.25.5.1.(1).)

- 1) *Air barrier systems* shall possess the characteristics necessary to provide an effective barrier to air infiltration and exfiltration under differential air pressure due to stack effect, mechanical systems or wind.
- 2) Where polyethylene sheet is used to provide airtightness in the *air barrier system*, it shall conform to CAN/CGSB-51.34-M, "Vapour Barrier, Polyethylene Sheet for Use in Building Construction."

#### **9.25.3.3. Continuity of the Air Barrier System**

1) Where the *air barrier system* consists of an air-impermeable panel-type material, all joints shall be sealed to prevent air leakage.

2) Except as provided in Sentence 9.25.3.6.(3), where the *air barrier system* consists of flexible sheet material, all joints shall be

a) sealed, or

b) lapped not less than 100 mm and clamped, such as between framing members, furring or blocking, and rigid panels.

3) Where an interior wall meets an exterior wall, ceiling, floor or roof required to be provided with air barrier protection, the *air barrier system* shall extend across the intersection.

4) Where an interior wall projects through a ceiling or extends to become an exterior wall, spaces in the wall shall be blocked to provide continuity across those spaces with the *air barrier system* in the abutting walls or ceiling.

5) Where an interior floor projects through an exterior wall or extends to become an exterior floor, continuity of the *air barrier system* shall be maintained from the abutting walls across the floor assembly.

6) Penetrations of the *air barrier system*, such as those created by the installation of doors, windows, electrical wiring, electrical boxes, piping or ductwork, shall be sealed to maintain the integrity of the *air barrier system* over the entire surface.

7) Where access hatches and sump pit covers are installed through assemblies constructed with an *air barrier system*, they shall be weatherstripped around their perimeters to prevent air leakage.

8) Clearances between *chimneys* or *gas vents* and the surrounding construction that would permit air leakage from within the *building* into a wall or *attic* or *roof space* shall be sealed by *noncombustible* material to prevent such leakage.

#### **9.25.3.4. Air Leakage Control in Masonry Walls**

(See Note A-9.25.3.4. and 9.25.3.6.)

1) Masonry walls required to provide a barrier to the ingress of air from the ground shall

a) include a course of masonry units without voids, or

b) be sealed with flashing material extending across the full width of the masonry.

2) The masonry course or flashing described in Sentence (1) shall

a) be located at the level of the adjoining floor and be sealed to it in accordance with Article 9.25.3.6., or

b) in the absence of a floor, be located at the level of the ground cover required by Article 9.18.6.1. and be sealed to it.

#### **9.25.3.5. Air Leakage Control in Underground Roofs**

1) Waterproofing systems for roofs of underground structures shall be sealed to the air barrier in the walls.

#### **9.25.3.6. Air Barrier Systems in Floors-on-ground**

(See Note A-9.25.3.4. and 9.25.3.6.)

1) Materials used to provide a barrier to the ingress of air through floors-on-ground shall conform to CAN/CGSB-51.34-M, "Vapour Barrier, Polyethylene Sheet for Use in Building Construction."

2) Where the floor-on-ground is a concrete slab, the air barrier shall be

- a) installed below the slab, or
- b) applied to the top of the slab, provided a separate floor is installed over the slab.

(See Note A-9.25.3.6.(2) and (3).)

3) Where the air barrier installed below a floor-on-ground is flexible sheet material, joints in the barrier shall be lapped not less than 300 mm. (See Note A-9.25.3.6.(2) and (3).)

4) Where installed in conjunction with a framed floor-on-ground or above a floor-on-ground, the air barrier shall be installed in accordance with Article 9.25.3.3.

5) A floor-on-ground shall be sealed around its perimeter to the inner surfaces of adjacent walls using flexible sealant.

6) All penetrations of a floor-on-ground that are required to drain water from the floor surface shall be sealed in a manner that prevents the upward flow of air without preventing the downward flow of liquid water.

## **9.25.4. Vapour Barriers**

### **9.25.4.1. Required Barrier to Vapour Diffusion**

1) Thermally insulated wall, ceiling and floor assemblies shall be constructed with a *vapour barrier* so as to provide a barrier to diffusion of water vapour from the interior into wall spaces, floor spaces or *attic or roof spaces*.

### **9.25.4.2. Vapour Barrier Materials**

1) Except as provided in Sentence (2), *vapour barriers* shall have a permeance not greater than  $60 \text{ ng}/(\text{Pa}\times\text{s}\times\text{m}^2)$  measured in accordance with ASTM E96/E96M, "Standard Test Methods for Water Vapor Transmission of Materials," using the desiccant method (dry cup).

2) Thermally insulated *foundation* wall assemblies are permitted to be constructed with variable-permeance *vapour barriers* having a permeance not greater than  $60 \text{ ng}/(\text{Pa}\times\text{s}\times\text{m}^2)$  using the desiccant method (dry cup) and greater than  $300 \text{ ng}/(\text{Pa}\times\text{s}\times\text{m}^2)$  using the water method (wet cup) measured in accordance with ASTM E96/E96M, "Standard Test Methods for Water Vapor Transmission of Materials." (See Note A-9.25.4.2.(2).)

3) Where the intended use of the interior space will result in high moisture generation, the assembly shall be designed according to Part 5. (See Note A-9.25.4.2.(3).)

4) Where polyethylene is installed to serve only as the *vapour barrier*, it shall comply with Clause 4.4, Thermal Stability, and Clause 5.7, Oxidative Induction Time, of CAN/CGSB-51.34-M, "Vapour Barrier, Polyethylene Sheet for Use in Building Construction."

5) Membrane-type *vapour barriers* other than polyethylene shall conform to the requirements of CAN/CGSB-51.33-M, "Vapour Barrier Sheet, Excluding Polyethylene, for Use in Building Construction."

6) Membrane-type *vapour barriers* other than polyethylene that are susceptible to deterioration under prolonged exposure to direct ultraviolet radiation shall

- a) be covered, or

- b) only be installed in locations that are not exposed to direct ultraviolet radiation after the completion of construction.

(See Note A-9.25.4.2.(6).)

7) Where a coating is applied to gypsum board to function as the *vapour barrier*, the permeance of the coating shall be determined in accordance with CAN/CGSB-1.501-M, "Method for Permeance of Coated Wallboard."

8) Where foamed plastic insulation functions as the *vapour barrier*, it shall be sufficiently thick so as to meet the requirement of Sentence (1).

#### **9.25.4.3. Installation of Vapour Barriers**

1) Products installed to function as the *vapour barrier* shall protect the warm side of wall, ceiling and floor assemblies.

2) Where different products are used for the *vapour barrier* and the insulation, the *vapour barrier* shall be installed sufficiently close to the warm side of the insulation to prevent condensation at design conditions. (See Notes A-9.25.4.3.(2) and A-9.25.5.1.(1).)

3) Where the same product is used for the *vapour barrier* and the insulation, the product shall be installed sufficiently close to the warm side of the assembly to prevent condensation at design conditions. (See Notes A-9.25.4.3.(2), A-9.25.5.1.(1) and A-9.25.5.2.)

### **9.25.5. Properties and Position of Materials in the Building Envelope**

#### **9.25.5.1. General**

(See Note A-9.25.5.1.)

1) Except as provided in Sentences (2) to (4), sheet and panel-type materials incorporated into assemblies described in Article 9.25.1.1. shall conform to Article 9.25.5.2., where

a) the material has

i) an air leakage characteristic less than  $0.1 \text{ L}/(\text{s}\times\text{m}^2)$  at 75 Pa, and

ii) a water vapour permeance less than  $60 \text{ ng}/(\text{Pa}\times\text{s}\times\text{m}^2)$  when measured in accordance with ASTM E96/E96M, "Standard Test Methods for Water Vapor Transmission of Materials," using the desiccant method (dry cup) (see Note A-9.25.5.1.(1)(a)(ii)), and

b) the intended use of the interior space where the materials are installed will not result in high moisture generation.

(See Note A-9.25.5.1.(1).)

2) Where the intended use of the interior space will result in high moisture generation, the assembly shall be designed according to Part 5.

3) Wood-based sheathing materials not more than 12.5 mm thick and complying with Article 9.23.17.2. need not comply with Sentence (1). (See Note A-9.25.5.1.(3).)

4) Where a material has a water vapour permeance not less than  $30 \text{ ng}/(\text{Pa}\times\text{s}\times\text{m}^2)$  and a thermal resistance not less than  $0.7 \text{ (m}^2\times\text{K)}/\text{W}$  and the heating degree-days of the *building* location are less than 6000, the assembly need not comply with Sentence (1).

#### **9.25.5.2. Position of Low Permeance Materials**

(See Note A-9.25.5.2.)

1) Sheet and panel-type materials described in Article 9.25.5.1. shall be installed

a) on the warm face of the assembly (see also Article 9.25.4.2.),



- b) at a location where the ratio between the total thermal resistance of all materials outboard of its innermost impermeable surface and the total thermal resistance of all materials inboard of that surface is not less than that required by Table 9.25.5.2., or
  - c) outboard of an air space that is vented to the outdoors.
- 2) For walls, the air space described in Clause (1)(c) shall comply with Clause 9.27.2.2.(1)(a).

**Table 9.25.5.2.**

**Ratio of Outboard to Inboard Thermal Resistance  
Forming Part of Sentence 9.25.5.2.(1)**

Heating Degree-Days of <i>Building Location</i> <sup>(1)</sup> , Celsius degree-days	Minimum Ratio of Total Thermal Resistance Outboard of Material's Inner Surface to Total Thermal Resistance Inboard of Material's Inner Surface
up to 4 999	0.20
5 000 to 5 999	0.30
6 000 to 6 999	0.35
7 000 to 7 999	0.40
8 000 to 8 999	0.50
9 000 to 9 999	0.55
10 000 to 10 999	0.60
11 000 to 11 999	0.65
12 000 or higher	0.75

**Notes to Table 9.25.5.2.:**

<sup>(1)</sup> See Sentence 1.1.3.1.(1).

## **Section 9.26. Roofing**

### **9.26.1. General**

#### **9.26.1.1. Definitions**

1) For the purpose of this Section, the term “roof” shall mean sloped or near-horizontal assemblies that protect the spaces beneath them, including platforms that effectively serve as roofs with respect to the accumulation or drainage of precipitation. (See Note A-9.26.1.1.(1).)

2) For the purpose of this Section, the term “roofing” shall mean the primary covering for roofs.

#### **9.26.1.2. Required Protection**

1) Roofs shall be protected with roofing, including flashing, installed so as to

- a) effectively shed water,
- b) prevent the ingress of water and moisture into *building* assemblies and occupied space, and

- c) minimize the ingress of water due to ice damming into *building* assemblies.

2) Compliance with Sentence (1) shall be demonstrated by conforming to

- a) the remainder of this Section, or

- b) Part 5.

**9.26.1.3. Alternative Installation Methods**

1) Methods described in CSA A123.51, “Asphalt shingle application on roof slopes 1:6 and steeper,” are permitted to be used for the installation of asphalt shingles in lieu of the methods described in this Section.

**9.26.2. Roofing Materials**

**9.26.2.1. Material Standards**

1) Materials used for the preparation of the substrate for roofing shall conform to the requirements of the applicable standards in Table 9.26.2.1.-A.

**Table 9.26.2.1.-A**  
**Materials for Preparation of the Substrate for Roofing**  
**Forming Part of Sentence 9.26.2.1.(1)**

Type of Material	Standards
Sheathing membranes	CAN/CGSB-51.32-M, “Sheathing, Membrane, Breather Type”
Primers	CGSB 37-GP-9Ma, “Primer, Asphalt, Unfilled, for Asphalt Roofing, Dampproofing and Waterproofing”

2) Roofing materials shall conform to the requirements of the applicable standards in Table 9.26.2.1.-B.

**Table 9.26.2.1.-B**  
**Roofing Materials**  
**Forming Part of Sentence 9.26.2.1.(2)**

Types of Roof Covering	Standards
Built-up roofing (BUR)	ASTM D3019/D3019M, “Standard Specification for Lap Cement Used with Asphalt Roll Roofing, Non-Fibered, and Fibered” <sup>(1)</sup>
	ASTM D4479/D4479M, “Standard Specification for Asphalt Roof Coatings – Asbestos-Free”
	CAN/CGSB-37.50-M, “Hot-Applied, Rubberized Asphalt for Roofing and Waterproofing”
	CGSB 37-GP-56M, “Membrane, Modified, Bituminous, Prefabricated, and Reinforced for Roofing”
	CAN/CSA-A123.2, “Asphalt-Coated Roofing Sheets”
	CSA A123.3, “Asphalt Saturated Organic Roofing Felt”
	CAN/CSA-A123.4, “Asphalt for Constructing Built-Up Roof Coverings and Waterproofing Systems”
	CSA A123.17, “Asphalt Glass Felt Used in Roofing and Waterproofing”
Single-ply membranes	ASTM D4637/D4637M, “Standard Specification for EPDM Sheet Used In Single-Ply Roof Membrane”
	ASTM D4811/D4811M, “Standard Specification for Nonvulcanized (Uncured) Rubber Sheet Used as Roof Flashing”
	ASTM D6878/D6878M, “Standard Specification for Thermoplastic Polyolefin Based Sheet Roofing”
	CAN/CGSB-37.54, “Polyvinyl Chloride Roofing and Waterproofing Membrane”

	CAN/CGSB-37.58-M, "Membrane, Elastomeric, Cold-Applied Liquid, for Non-Exposed Use in Roofing and Waterproofing"
Shingles, shakes, tiles, panels	CSA A123.5, "Asphalt shingles made from glass felt and surfaced with mineral granules"
	CAN/CSA-A220 Series, "Concrete Roof Tiles"
	CSA O118.1, "Western Red Cedar Shakes and Shingles"
	CSA O118.2, "Eastern White Cedar Shingles"
Eave protection	CAN/CSA-A123.16, "Asphalt-coated glass-base sheets"
	CSA A123.22, "Self-Adhering Polymer Modified Bituminous Sheet Materials Used as Steep Roofing Underlayment for Ice Dam Protection"
Flashing	ASTM D4811/D4811M, "Standard Specification for Nonvulcanized (Uncured) Rubber Sheet Used as Roof Flashing"

**Notes to Table 9.26.2.1.-B:**

<sup>(1)</sup> For the purpose of this Subsection, ASTM D3019/D3019M shall only apply to the non-fibered and non-asbestos-fibered types (I and III) of asphalt roll roofing.

**9.26.2.2. Installation of Materials**

1) Materials listed in Tables 9.26.2.1.-A and 9.26.2.1.-B shall be installed in conformance with the manufacturer's written instructions. (See Sentence 1.5.1.2.(1) of Division A.)

**9.26.2.3. Nails**

- 1) Nails used for roofing shall be corrosion-resistant roofing or shingle nails conforming to
  - a) ASTM F1667, "Standard Specification for Driven Fasteners: Nails, Spikes, and Staples," or
  - b) CSA B111, "Wire Nails, Spikes and Staples."
- 2) Nails shall have sufficient length to penetrate through, or 12 mm into, roof sheathing.
- 3) Nails used with asphalt roofing shall have a head diameter of not less than 9.5 mm and a shank thickness of not less than 2.95 mm.
- 4) Nails used with wood shingles or shakes shall have a head diameter of not less than 4.8 mm and a shank thickness of not less than 2.0 mm and shall be stainless steel, aluminum or hot-dipped galvanized. (See Note A-9.26.2.3.(4).)

**9.26.2.4. Staples**

- 1) Staples used to apply asphalt or wood shingles shall be corrosion-resistant and shall be driven with the crown parallel to the eaves.
- 2) Staples used with asphalt shingles shall be not less than 19 mm long, 1.6 mm diam or thickness, with not less than a 25 mm crown, except that an 11 mm crown may be used as provided in Sentence 9.26.7.4.(2).
- 3) Staples used with wood shingles shall be not less than 29 mm long, 1.6 mm diam or thickness, with not less than a 9.5 mm crown and shall be stainless steel or aluminum. (See Note A-9.26.2.3.(4).)

**9.26.3. Slope of Roofed Surfaces**

**9.26.3.1. Slope**

1) Except as provided in Sentences (2) and (3), the slopes on which roof coverings may be applied shall conform to Table 9.26.3.1.

2) Asphalt and gravel or coal tar and gravel roofs may be constructed with lower slopes than required in Sentence (1) when effective drainage is provided by roof drains located at the lowest points on the roofs.

3) Profiled metal roof cladding systems specifically designed for low-slope applications are permitted to be installed with lower slopes than required by Sentence (1), provided they are installed in conformance with the manufacturer's written recommendations.

4) Except where back-slope will not adversely affect adjacent supported or supporting constructions due to water ingress, roofs and constructions that effectively serve as roofs shall be constructed with sufficient slope away from

a) exterior walls, and

b) *guards* that are connected to the roof, or to a construction that effectively serves as a roof, by more than pickets or posts.

(See Notes A-9.26.1.1.(1), A-9.26.4.1. and A-9.27.3.8.(4).)

5) The slope required by Sentence (4) shall be sufficient to maintain a positive slope

a) after expected shrinkage of the *building* frame, where these surfaces are supported by exterior walls and exterior columns (see Note A-9.27.3.8.(4)), and

b) once design loading is taken into consideration, where these surfaces are cantilevered from exterior walls.

Table 9.26.3.1.

Roofing Types and Slope Limits

**Forming Part of Sentence 9.26.3.1.(1)**

Type of Roofing	Minimum Slope	Maximum Slope
Asphalt Shingles		
Low slope application	1 in 6	no limit
Normal application	1 in 3	no limit
Built-up Roofing		
Asphalt base (without gravel)	1 in 25	1 in 2
Asphalt base (gravelled)	1 in 50 <sup>(1)</sup>	1 in 4
Coal-tar base (gravelled)	1 in 50 <sup>(1)</sup>	1 in 25
Cold process	1 in 25	1 in 1.33
Cedar Shakes	1 in 3	no limit
Clay Tile	1 in 2	no limit
Glass Fibre Reinforced Polyester Roofing Panels	1 in 4	no limit
Modified Bituminous Membranes	1 in 50	1 in 4
Profiled Metal Roofing	1 in 4 <sup>(1)</sup>	no limit
Roll Roofing		
480 mm wide selvage asphalt roofing	1 in 6	no limit
Cold application felt	1 in 50	1 in 1.33

Smooth and mineral surfaced	1 in 4	no limit
Sheet Metal Shingles	1 in 4 <sup>(1)</sup>	no limit
Slate Shingles	1 in 2	no limit
Wood Shingles	1 in 4	no limit

**Notes to Table 9.26.3.1.:**

<sup>(1)</sup> See Sentence 9.26.3.1.(3).

## **9.26.4. Flashing at Intersections**

### **9.26.4.1. Required Flashing at Intersections**

(See Notes A-9.26.4.1. and A-9.26.1.1.(1).)

1) Except where the omission of flashing will not adversely affect adjacent supported or supporting constructions, flashing shall be installed at junctions between roofs and

- a) walls that rise above the roof, and
- b) *guards* that are connected to the roof by more than pickets or posts.

2) For the purpose of Sentence (1), roofs shall include platforms that effectively serve as roofs with respect to the accumulation or drainage of precipitation.

### **9.26.4.2. Materials**

1) Sheet metal flashing shall consist of not less than

- a) 1.73 mm thick sheet lead,
- b) 0.33 mm thick galvanized steel,
- c) 0.33 mm thick copper,
- d) 0.35 mm thick zinc, or
- e) 0.48 mm thick aluminum.

### **9.26.4.3. Valley Flashing**

1) Where sloping surfaces of shingled roofs intersect to form a valley, the valley shall be flashed.

2) Valley flashing shall be installed over continuous sheathing.

3) Closed valleys shall not be used with rigid shingles on slopes of less than 1 in 1.2.

4) Open valleys shall be flashed with at least

- a) one layer of sheet metal not less than 600 mm wide, or
- b) 2 layers of roll roofing.

5) The bottom layer of roofing required in Sentence (4) shall consist of at least Type S smooth roll roofing or Type M mineral surface roll roofing (mineral surface down) not less than 457 mm wide, centred in the valley and fastened with nails spaced not more than 450 mm o.c. located 25 mm away from the edges.

6) The top layer of roofing required in Sentence (4) shall consist of at least Type M mineral surface roll roofing (mineral surface up), 914 mm wide, centred in the valley, applied over a 100 mm wide strip of cement along each edge of the bottom layer, and fastened with a sufficient number of nails to hold it in place until the shingles are applied.

#### **9.26.4.4. Intersection of Shingle Roofs and Masonry**

- 1) The intersection of shingle roofs and masonry walls or *chimneys* shall be protected with flashing.
- 2) Counter flashing required in Sentence (1) shall be embedded not less than 25 mm in the masonry and shall extend not less than 150 mm down the masonry and lap the lower flashing not less than 100 mm.
- 3) Flashing along the slopes of a roof described in Sentence (1) shall be stepped so that there is not less than a 75 mm head lap in both the lower flashing and counter flashing.
- 4) Where the roof described in Sentence (1) slopes upwards from the masonry, the flashing shall extend up the roof slope to a point equal in height to the flashing on the masonry, but not less than 1.5 times the shingle exposure.

#### **9.26.4.5. Intersection of Shingle Roofs and Walls other than Masonry**

- 1) The intersection of shingle roofs and walls clad with other than masonry shall be protected with flashing.
- 2) Flashing required in Sentence (1) shall be installed so that it extends up the wall not less than 75 mm behind the sheathing paper, and extends not less than 75 mm horizontally.
- 3) Along the slope of the roof, the flashing required in Sentence (1) shall be stepped with not less than a 75 mm head lap.

#### **9.26.4.6. Intersection of Built-Up Roofs and Masonry**

- 1) The intersection of built-up roofs with masonry walls or *chimneys* shall have a cant strip at the intersection, and a roofing membrane shall be mopped over the cant strip and not less than 150 mm up the wall.
- 2) Counter flashing installed over the intersection referred to in Sentence (1) shall be embedded not less than 25 mm in the masonry, and shall be of sufficient length to extend down not less than 150 mm, lapping the membrane on the masonry not less than 100 mm.

#### **9.26.4.7. Intersection of Built-Up Roofs and Walls other than Masonry**

- 1) The intersection of built-up roofs with walls clad with other than masonry shall have a cant strip at the intersection.
- 2) The roofing membrane shall be mopped over the cant strip referred to in Sentence (1).
- 3) Flashing plies shall extend not less than 150 mm up the wall referred to in Sentence (1) behind the sheathing paper.

#### **9.26.4.8. Chimney Saddles**

- 1) Except as otherwise permitted in Sentence (5), *chimney* saddles shall be installed where the upper side of a *chimney* on a sloping roof is more than 750 mm wide.
- 2) *Chimney* saddles shall be covered with sheet metal or roofing material of weight and quality equivalent to the roofing.
- 3) Saddles shall be flashed where they intersect the roof.
- 4) The intersection of the saddle and the *chimney* shall be flashed and counterflashed as described in Article 9.26.4.4.
- 5) A *chimney* saddle need not be installed if the intersection between the *chimney* and roof is protected by sheet metal flashing that extends up the *chimney* to a height equal to at least one

sixth the width of the *chimney*, but not less than 150 mm, and up the roof slope to a point equal in height to the flashing on the *chimney*, but not less than 1.5 times the shingle exposure.

6) Flashing described in Sentence (5) at the *chimney* shall be counterflashed as required by Article 9.26.4.4.

## **9.26.5. Eave Protection for Shingles and Shakes**

### **9.26.5.1. Required Eave Protection**

1) Except as provided in Sentence (2), eave protection shall be provided on shingle, shake or tile roofs, extending from the edge of the roof a minimum of 900 mm up the roof slope to a line not less than 300 mm inside the inner face of the exterior wall.

2) Eave protection is not required

a) over unheated garages, carports and porches,

b) where the roof overhang exceeds 900 mm measured along the roof slope from the edge of the roof to the inner face of the exterior wall,

c) on roofs of asphalt shingles installed in accordance with Subsection 9.26.8.,

d) on roofs with slopes of 1 in 1.5 or greater, or

e) in regions with 3 500 or fewer degree-days.

### **9.26.5.2. Materials**

1) Eave protection shall be laid beneath the starter strip and shall consist of

a) No. 15 asphalt-saturated felt laid in two plies lapped 480 mm and cemented together with lap cement,

b) Type M or S roll roofing laid with not less than 100 mm head and end laps cemented together with lap cement,

c) glass fibre or polyester fibre coated base sheets, or

d) self-sealing composite membranes consisting of modified bituminous coated material.

## **9.26.6. Underlay beneath Shingles**

### **9.26.6.1. Materials**

1) Except as required in Sentence (2), when underlay is used beneath shingles, it shall be

a) asphalt-saturated sheathing paper weighing not less than 0.195 kg/m<sup>2</sup>, or

b) No. 15 plain or perforated asphalt-saturated felt.

2) Underlay used beneath wood shingles shall be breather type.

### **9.26.6.2. Installation**

1) When used with shingles, underlay shall be installed parallel to the eaves with head and end lap of not less than 50 mm.

2) The top edge of each strip of underlay referred to in Sentence (1) shall be fastened with sufficient roofing nails to hold it in place until the shingles are applied.

3) The underlay referred to in Sentence (1) shall overlap the eave protection by not less than 100 mm. (See Article 9.26.10.2. for underlay beneath wood shakes.)

## **9.26.7. Asphalt Shingles on Slopes of 1 in 3 or Greater**

#### **9.26.7.1. Coverage**

1) Coverage shall be not less than 2 thicknesses of shingle over the entire roof, disregarding cutouts.

#### **9.26.7.2. Starter Strip**

1) A starter strip shall be installed along the lower edge of the roof so that it extends approximately 12 mm beyond the eaves and rake of the roof and fastened along the bottom edge with nails spaced not more than 300 mm o.c.

2) Starter strips shall be

a) at least Type M mineral-surfaced roll roofing not less than 300 mm wide,

b) shingles of the same weight and quality as those used as a roof covering with tabs facing up the roof slope, or

c) pre-manufactured starter strips installed with sealant at the eaves.

3) Starter strips need not be provided where eave protection of not less than Type M mineral-surfaced roll roofing is provided.

#### **9.26.7.3. Head Lap**

1) Shingles shall have a head lap of not less than 50 mm.

#### **9.26.7.4. Fasteners**

1) Except as provided in Sentence (2), shingles shall be fastened with at least 4 nails or staples for 1 m wide shingles so that no nails or staples are exposed.

2) Where staples with an 11 mm crown are used, shingles shall be fastened with at least 6 staples.

3) Fasteners may be reduced for narrower shingles in proportion to the width of the shingle or when shingles incorporating interlocking devices are used.

4) Fasteners referred to in Sentences (1) and (2) shall be located 25 mm to 40 mm from each end of each strip shingle with other fasteners equally spaced between them.

5) Fasteners referred to in Sentences (1) and (2) shall be located not less than 12 mm above the tops of the cutouts.

#### **9.26.7.5. Securing of Tabs**

1) Shingle tabs shall be secured by a spot of plastic cement not exceeding 25 mm diam under the centre of each tab or by interlocking devices or self-sealing strips.

#### **9.26.7.6. Hips and Ridges**

1) Shingles on hips and ridges shall be applied so they extend not less than 100 mm on either side of the hip or ridge, and shall be lapped not less than 150 mm.

2) Shingles referred to in Sentence (1) shall be fastened with nails or staples on each side located not more than 25 mm from the edge and 25 mm above the butt of the overlying shingle.

#### **9.26.7.7. Eave Protection**

1) Eave protection shall conform to Subsection 9.26.5.

#### **9.26.7.8. Flashing**

1) Flashing shall conform to Subsection 9.26.4.



## **9.26.8. Asphalt Shingles on Slopes of less than 1 in 3**

### **9.26.8.1. Coverage**

1) Except for the first 2 courses, coverage shall be not less than 3 thicknesses of shingle over the entire roof, disregarding cutouts.

### **9.26.8.2. Starter Strip**

- 1) A starter strip shall be installed as in Article 9.26.7.2.
- 2) Starter strips required in Sentence (1) shall be laid in a continuous band of cement not less than 200 mm wide.

### **9.26.8.3. Securing of Tabs**

1) Shingle tabs shall be secured with cold application cement applied at the rate of not less than 0.5 L/m<sup>2</sup> of cemented area, or hot application asphalt applied at the rate of 1 kg/m<sup>2</sup> of cemented area.

### **9.26.8.4. Securing of Shingle Courses**

- 1) The first course of shingles shall be secured by a continuous band of cement along the eaves applied so that the width of the band equals the shingle exposure plus 100 mm.
- 2) The succeeding courses of shingles shall be secured by a continuous band of cement applied so that the width of the band equals the shingle exposure plus 50 mm.
- 3) The band required in Sentence (2) shall be located not more than 50 mm above the butt of the overlying course of shingles.

### **9.26.8.5. Hips and Ridges**

- 1) Shingles on hips and ridges shall be not less than 300 mm wide applied to provide triple coverage.
- 2) Shingles referred to in Sentence (1) shall be cemented to the roof shingles and to each other with a coat of cement and fastened with nails or staples located 40 mm above the butt of the overlying shingle and 50 mm from each edge.

### **9.26.8.6. Flashing**

- 1) Flashing shall conform to Subsection 9.26.4.

### **9.26.8.7. Fastening**

- 1) Shingles shall be fastened in accordance with Article 9.26.7.4.

## **9.26.9. Wood Roof Shingles**

### **9.26.9.1. Decking**

1) Except as provided in Sentence 9.23.16.1.(1), decking for wood shingled roofs may be continuous or spaced.

### **9.26.9.2. Grade**

- 1) Western cedar shingles shall be not less than No. 2 grade.
- 2) Eastern white cedar shingles shall be not less than B (clear) grade.

### **9.26.9.3. Size**

1) Wood shingles shall be not less than 400 mm long and not less than 75 mm or more than 350 mm wide.

#### 9.26.9.4. Spacing and Joints

1) Shingles shall be spaced approximately 6 mm apart and offset at the joints in adjacent courses not less than 40 mm so that joints in alternate courses are staggered.

#### 9.26.9.5. Fastening

1) Shingles shall be fastened with 2 nails or staples located approximately 20 mm from the sides of the shingle and 40 mm above the exposure line.

#### 9.26.9.6. Exposure

1) The exposure of wood roof shingles shall conform to Table 9.26.9.6.

**Table 9.26.9.6.**

**Exposure of Wood Roof Shingles  
Forming Part of Sentence 9.26.9.6.(1)**

Roof Slope	Maximum Exposure, mm					
	No. 1 or A Grade Length of Shingle, mm			No. 2 or B Grade Length of Shingle, mm		
	400	450	600	400	450	600
<1 in 3	100	115	165	90	100	140
≥ 1 in 3	125	140	190	100	115	165

#### 9.26.9.7. Flashing

1) Flashing shall conform to Subsection 9.26.4.

#### 9.26.9.8. Eave Protection

1) Eave protection shall conform to Subsection 9.26.5.

#### 9.26.10. Cedar Roof Shakes

##### 9.26.10.1. Size and Thickness

1) Shakes shall be not less than 450 mm long and not less than 100 mm nor more than 350 mm wide with a butt thickness of not more than 32 mm and not less than 9 mm.

##### 9.26.10.2. Underlay

1) Where eave protection is not provided, an underlay conforming to the requirements in Article 9.26.6.1. for wood shingles shall be laid as a strip not less than 900 mm wide along the eaves.

2) A strip of material similar to that described in Sentence (1) not less than 450 mm wide shall be interlaid between each course of shakes with the bottom edge of the strip positioned above the butt line at a distance equal to double the exposure of the shakes.

3) Interlaid strips referred to in Sentence (2) shall be lapped not less than 150 mm at hips and ridges in a manner that will prevent water from reaching the roof sheathing.

##### 9.26.10.3. Spacing and Joints

1) Shakes shall be spaced 6 mm to 9 mm apart and the joints in any one course shall be separated not less than 40 mm from joints in adjacent courses.

##### 9.26.10.4. Fastening

1) Shakes shall be fastened with nails located approximately 20 mm from the sides of the shakes and 40 mm above the exposure line.

**9.26.10.5. Exposure**

- 1) The exposure of wood shakes shall not exceed
  - a) 190 mm for shakes not less than 450 mm long, and
  - b) 250 mm for shakes not less than 600 mm long.

**9.26.10.6. Flashing**

- 1) Flashing shall conform to Subsection 9.26.4.

**9.26.10.7. Eave Protection**

- 1) Eave protection shall conform to Subsection 9.26.5.

**9.26.10.8. Grade**

- 1) Shakes shall be not less than No. 1 or Handsplit grade.

**9.26.11. Built-Up Roofs**

**9.26.11.1. Quantity of Materials**

1) The quantities of bituminous materials used on built-up roofs shall conform to Table 9.26.11.1.

**Table 9.26.11.1.**  
**Quantities of Bitumen for Built-up Roofs**  
**Forming Part of Sentence 9.26.11.1.(1)**

Type of Roof	Amount of Bitumen per Square Metre of Roof Surface	
	Mopping Coats between Layers	Flood Coat
Asphalt and aggregate	1 kg	3 kg
Coal-tar and aggregate	1.2 kg	3.6 kg
Cold process roofing	0.75 L cold process cement	2 L cold process top coating

**9.26.11.2. Coal-Tar and Asphalt Products**

1) Coal-tar products and asphalt products shall not be used together in built-up roof construction.

**9.26.11.3. Roof Felts**

- 1) Bitumen roofing felts shall be at least No. 15 felt.

**9.26.11.4. Aggregate Surfacing**

1) Aggregate used for surfacing built-up roofs shall be clean, dry and durable and shall consist of particles of gravel, crushed stone or air-cooled blast *furnace* slag having a size of from 6 mm to 15 mm.

2) The minimum amount of aggregate surfacing per square metre of roof surface shall be 15 kg gravel or crushed stone or 10 kg crushed slag.

**9.26.11.5. Flashing**

- 1) Flashing for built-up roofs shall conform to Subsection 9.26.4.

**9.26.11.6. Number of Layers**

1) Built-up roofing shall consist of not less than 3 mopped-down layers of roofing felt flood coated with bitumen.

#### **9.26.11.7. Installation of Layers**

1) In hot process applications each layer of bitumen-saturated felt shall be laid while the bitumen is hot, with each layer overlapping the previous one.

2) The full width under each lap referred to in Sentence (1) shall be coated with bitumen so that in no place does felt touch felt.

3) Felt shall be laid free of wrinkles and shall be rolled directly into the hot bitumen and broomed forward and outward from the centre to ensure complete adhesion.

#### **9.26.11.8. Roofing over Wood-Based Sheathing**

1) Except as permitted in Sentence (2), built-up roofing applied over wood, plywood, OSB or waferboard roof sheathing shall be laid over an additional base layer of felt laid dry over the entire roof deck with not less than a 50 mm headlap and a 50 mm sidelap between each sheet.

2) Where plywood, OSB or waferboard roof sheathing is used, the dry layer of felt required in Sentence (1) may be omitted when the joints are taped and the sheathing is primed with asphalt.

#### **9.26.11.9. Attachment to Decking**

1) Roofing shall be securely attached to the decking or where insulation is applied above the deck, the insulation shall be securely attached to the deck before the first layer of felt is fastened to the insulation.

#### **9.26.11.10. Cant Strips**

1) Except as permitted in Sentence (4), a cant strip shall be provided at the edges of roofs.

2) At least 2 plies of the roofing membrane shall be carried over the top of the cant strip.

3) Flashing shall extend over the top of the cant strip and be shaped to form a drip.

4) The cant strip required in Sentence (1) need not be provided where a gravel stop is installed at the edge of roofs.

5) The roofing membranes shall be carried over the edge of the roof before the gravel stop referred to in Sentence (4) is fastened and 2 plies of roofing membrane mopped to the top surface of the gravel stop before the flood coat is applied.

6) The gravel stop referred to in Sentence (4) shall extend over the edge of the roof to form a drip or shall be flashed so that the flashing extends over the edge to form a drip.

### **9.26.12. Selvage Roofing**

#### **9.26.12.1. Coverage**

1) Wide selvage asphalt roofing shall provide double coverage over the entire roof surface.

#### **9.26.12.2. Joints**

1) Plies of selvage roofing shall be cemented together to ensure a watertight joint.

### **9.26.13. Sheet Metal Roofing**

#### **9.26.13.1. Thickness**

1) Sheet metal roofing shall be not less than

a) 0.33 mm thick galvanized steel,

- b) 0.46 mm thick copper,
- c) 0.46 mm thick zinc, or
- d) 0.48 mm thick aluminum.

#### **9.26.13.2. Support**

1) Except as provided in Sentence 9.23.16.1.(1), where sheet metal roofing is not supported by roof decking but spans between spaced supports, the panels shall be designed to support the specified *live loads* for roofs.

### **9.26.14. Glass Reinforced Polyester Roofing**

#### **9.26.14.1. Support**

1) Except as provided in Sentence 9.23.16.1.(1), where glass-reinforced polyester roofing panels are not supported by roof decking but span between spaced supports, the panels shall be designed to support the specified live roof loads.

### **9.26.15. Hot Applied Rubberized Asphalt Roofing**

#### **9.26.15.1. Installation**

1) Hot applied rubberized asphalt roofing shall be installed in accordance with CAN/CGSB-37.51-M, "Application for Hot-Applied Rubberized Asphalt for Roofing and Waterproofing."

### **9.26.16. Polyvinyl Chloride Sheet Roofing**

#### **9.26.16.1. Installation**

1) Polyvinyl chloride sheet applied roofing membrane shall be installed in accordance with CGSB 37-GP-55M, "Application of Sheet Applied Flexible Polyvinyl Chloride Roofing Membrane."

### **9.26.17. Concrete Roof Tiles**

#### **9.26.17.1. Installation**

1) Except as provided in Sentence 9.23.16.1.(1), concrete roof tiles shall be installed according to CAN/CSA-A220 Series, "Concrete Roof Tiles." (See Note A-9.26.17.1.(1).)

### **9.26.18. Roof Drains and Downspouts**

#### **9.26.18.1. Roof Drains**

1) When roof drains are provided they shall conform to Part 7.

#### **9.26.18.2. Downspouts**

1) Where downspouts are provided and are not connected to a sewer, extensions shall be provided to carry rainwater away from the *building* in a manner which will prevent *soil* erosion.

#### **9.26.18.3. Roof or Balcony Parapet Walls**

1) Where a roof or balcony is entirely enclosed by parapet walls, a secondary means of drainage, such as scuppers or overflow outlets shall be installed in the parapet walls, in addition to drains. (See Note A-9.26.18.3.(1).)

## **Section 9.27. Cladding**

### **9.27.1. Application**

### **9.27.1.1. General**

1) Where lumber, wood shingles, shakes, fibre-cement shingles, planks and sheets, plywood, OSB, waferboard, hardboard, vinyl, insulated vinyl, polypropylene, aluminum or steel, including trim and soffits, are installed as cladding on wood-frame walls or above-ground flat insulating concrete form walls exposed to precipitation, the cladding assembly shall comply with

- a) Subsections 9.27.2. to 9.27.13., or
- b) Part 5.

2) Where stucco is installed as cladding on wood-frame walls, above-ground flat insulating concrete form walls or masonry walls exposed to precipitation, the cladding assembly shall comply with

- a) Subsections 9.27.2. to 9.27.5., and Section 9.28., or
- b) Part 5.

3) Where masonry serves as cladding on wood-frame walls, above-ground flat insulating concrete form walls or masonry walls exposed to precipitation, the cladding assembly shall comply with

a) Subsections 9.27.2. to 9.27.4., and Section 9.20., except for masonry veneer, which shall be attached to above-ground flat insulating concrete form walls in accordance with Sentence 9.27.5.4.(2), or

- b) Part 5.

4) Where asphalt shingles are installed as cladding on wood-frame walls exposed to precipitation, the cladding assembly shall comply with

- a) Subsections 9.26.7. and 9.27.2. to 9.27.4., or
- b) Part 5.

5) Where an exterior insulation finish system is installed as cladding on wood-frame, masonry, cold-formed steel stud, above-ground flat insulating concrete form or cast-in-place concrete walls exposed to precipitation, the cladding assembly shall comply with

- a) Subsections 9.25.5., 9.27.2. to 9.27.4., and 9.27.14., or
- b) Part 5.

(See Note A-9.27.1.1.(5).)

6) Where cladding materials other than those described in Sentences (1) to (5) are installed, or where the cladding materials described in Sentences (1) to (5) are installed on substrates other than those identified in Sentences (1) to (5), the materials and installation shall comply with Part 5.

### **9.27.2. Required Protection from Precipitation**

(See Note A-9.27.2.)

#### **9.27.2.1. Minimizing and Preventing Ingress and Damage**

1) Except where exterior walls are protected from precipitation or where it can be shown that precipitation ingress will not adversely affect occupant health or safety, exterior walls shall be designed and constructed to

- a) minimize the ingress of precipitation into the assembly, and

b) prevent the ingress of precipitation into interior space.

(See Note A-9.27.2.1.(1).)

2) Except where exterior walls are protected from specific mechanisms of deterioration, such as mechanical impact and ultraviolet radiation, exterior walls shall be designed and constructed to minimize the likelihood of their required performance being reduced to an unacceptable level as a result of those mechanisms.

#### **9.27.2.2. Minimum Protection from Precipitation Ingress**

(See Note A-9.27.2.2.)

1) Except as provided in Sentence (2), a cladding assembly is deemed to have a capillary break between the cladding and the backing assembly, where

a) there is a drained and vented air space not less than 9.5 mm deep behind the cladding, over the full height and width of the wall (see also Article 9.27.5.3.),

b) an open drainage material, not less than 10 mm thick and with a cross-sectional area that is not less than 80% open, is installed between the cladding and the backing, over the full height and width of the wall,

c) the cladding is loosely fastened to the backing and behind each cladding component there is a clear air space that is

i) continuous for the full width of the component,

ii) not less than 10 mm deep at the bottom of the component, and

iii) not less than 6 mm deep over not less than 90 mm for every 230 mm of exposed height of the component,

d) the wall is a masonry *cavity wall* or the cladding is masonry veneer constructed according to Section 9.20., or

e) the cladding conforms to Subsection 9.27.14.

2) The drained and vented air space, and drainage material described in Sentence (1) may be interrupted by

a) penetrations for windows, doors and services,

b) flashing, and

c) furring, provided the furring does not make up more than 20% of the furred area.

3) Where a construction projects over the top of the drained and vented air space described in Clause (1)(a) or over the drainage material described in Clause (1)(b), the air space or drainage material shall not be contiguous with concealed spaces in the projecting construction.

4) Exterior walls exposed to precipitation shall be protected against precipitation ingress by an exterior cladding assembly consisting of a first plane of protection and a second plane of protection, where such walls enclose spaces of *residential occupancy* or spaces that directly serve spaces of *residential occupancy*.

5) Except as provided in Sentence (6), exterior walls exposed to precipitation shall be protected against precipitation ingress by an exterior cladding assembly consisting of a first plane of protection and a second plane of protection incorporating a capillary break, where

a) the number of degree-days is less than 3400 and the moisture index is greater than 0.90,  
or

b) the number of degree-days is 3400 or more, and the moisture index is greater than 1.00.  
(See Sentence 1.1.3.1.(1) and Appendix C for information on the moisture index.)

6) In exterior walls described in Sentence (5), the first and second planes of protection need not incorporate a capillary break, where

a) it can be shown that omitting the capillary break will not adversely affect the performance of the *building* assemblies,

b) the *building* is an accessory *building*, or

c) the wall

i) is constructed of non-moisture-sensitive materials, and intersecting or supported floors are also constructed of non-moisture-sensitive materials, or

ii) is constructed as a mass wall of sufficient thickness to minimize the transfer of moisture to the interior.

### **9.27.2.3. First and Second Planes of Protection**

1) Where walls required to provide protection from precipitation comprise cladding assemblies with first and second planes of protection,

a) the first plane of protection shall

i) consist of cladding with appropriate trim, accessory pieces and fasteners, and

ii) be designed and constructed to minimize the passage of rain and snow into the wall by minimizing holes and managing precipitation ingress caused by the kinetic energy of raindrops, surface tension, capillarity, gravity, and air pressure differences (see Subsection 9.27.4.),

b) the second plane of protection shall be designed and constructed to (see Subsection 9.27.3.)

i) intercept all rain and snow that gets past the first plane of protection, and

ii) effectively dissipate any rain or snow to the exterior, and

c) the protection provided by the first and second planes of protection shall be maintained

i) at wall penetrations created by the installation of components and services such as windows, doors, ventilation ducts, piping, wiring and electrical outlets, and

ii) at the interface with other wall assemblies.

### **9.27.2.4. Protection of Cladding from Moisture**

1) A clearance of not less than 200 mm shall be provided between finished ground and cladding that is adversely affected by moisture, such as untreated wood, plywood, OSB, waferboard and hardboard.

2) A clearance of not less than 50 mm shall be provided between a roof surface and cladding that is adversely affected by moisture, such as untreated wood, plywood, OSB, waferboard and hardboard.

## **9.27.3. Second Plane of Protection**

### **9.27.3.1. Elements of the Second Plane of Protection**

(See Note A-9.27.3.1.)



- 1) The second plane of protection shall consist of a drainage plane having an appropriate inner boundary and flashing to dissipate rainwater to the exterior.
- 2) Except for cladding systems conforming to Subsection 9.27.14., the inner boundary of the drainage plane shall comply with Articles 9.27.3.2. to 9.27.3.6.
- 3) The protection provided by the second plane of protection shall be maintained
  - a) at wall penetrations created by the installation of components and services such as windows, doors, ventilation ducts, piping, wiring and electrical outlets, and
  - b) at the interface with other wall assemblies.
- 4) Flashing material and its installation shall comply with Articles 9.27.3.7. and 9.27.3.8.

#### **9.27.3.2. Sheathing Membrane Material Standard**

1) Sheathing membranes shall conform to the performance requirements of CAN/CGSB-51.32-M, "Sheathing, Membrane, Breather Type."

#### **9.27.3.3. Required Sheathing Membrane and Installation**

- 1) Except as provided in Articles 9.27.3.4. to 9.27.3.6., at least one layer of sheathing membrane shall be applied beneath cladding.
- 2) Sheathing membrane required in Sentence (1) shall be applied so that joints are lapped not less than 100 mm.
- 3) Where sheathing membrane required in Sentence (1) is applied horizontally, the upper sheets shall overlap the lower sheets.

#### **9.27.3.4. Insulating Sheathing in lieu of Sheathing Membrane**

- 1) Where non-wood-based rigid exterior insulating sheathing, or exterior insulating sheathing with an integral sheathing membrane is installed, a separate sheathing membrane is not required.
- 2) Where insulating sheathing is installed as provided in Sentence (1),
  - a) sheathing panels subject to moisture deterioration shall be sealed at all joints, and
  - b) the joints of sheathing panels not subject to moisture deterioration shall be
    - i) sealed at all joints, or
    - ii) lapped or tongue and groove, and detailed to ensure drainage of water to the exterior.

(See Note A-9.27.3.4.(2).)

#### **9.27.3.5. Sheathing Membranes in lieu of Sheathing**

- 1) Except as provided in Article 9.27.3.6., where no sheathing is used, at least 2 layers of sheathing membrane shall be applied beneath the cladding. (See Article 9.23.17.1. and Note A-9.27.3.5.(1).)
- 2) All joints in the sheathing membrane required in Sentence (1) shall occur over framing, and the membrane shall be fastened to the framing with roofing nails or staples spaced not more than 150 mm along the edges of the outer layer of sheathing membrane.
- 3) Wall sheathing is permitted to be used in lieu of one layer of sheathing membrane required in Sentence (1), and its thickness need not conform to Table 9.23.17.2.-A.

#### **9.27.3.6. Face Sealed Cladding**

(See Note A-9.27.3.6.)

1) Sheathing membrane is permitted to be omitted beneath cladding when the joints in the cladding are formed to effectively prevent the passage of wind and rain in conformance with Sentence (2) or (3), as applicable.

2) Cladding consisting of sheets of plywood, hardboard, OSB, waferboard or fibre cement is considered to meet the requirements of Sentence (1), provided the cladding is applied so that

- a) all edges are directly supported by framing,
- b) the vertical joints between adjacent sheets are sealed and
  - i) covered with battens,
  - ii) shiplapped, or
  - iii) otherwise matched to provide weathertight joints, and
- c) the horizontal joints between adjacent sheets are sealed and
  - i) shiplapped, or
  - ii) otherwise matched to provide weathertight joints.

3) Metal siding consisting of sheets of metal is considered to meet the requirements of Sentence (1) where the joints between sheets are of the locked-seam type.

#### **9.27.3.7. Flashing Materials**

1) Flashing shall consist of not less than

- a) 1.73 mm thick sheet lead,
- b) 0.33 mm thick galvanized steel,
- c) 0.46 mm thick copper,
- d) 0.46 mm thick zinc,
- e) 0.48 mm thick aluminum, or
- f) 1.02 mm thick vinyl.

#### **9.27.3.8. Flashing Installation**

1) Except as provided in Sentence (2), flashing shall be installed at

- a) every horizontal junction between cladding elements,
- b) every horizontal offset in the cladding, and
- c) every horizontal line where the cladding substrates change and where
  - i) the substrates differ sufficiently for stresses to be concentrated along that line, or
  - ii) the installation of the cladding on the lower substrate may compromise the drainage of moisture from behind the cladding above.

(See Note A-9.27.3.8.(1).)

2) Flashing need not be installed as described in Sentence (1)

- a) where the upper cladding elements overlap the lower cladding elements by not less than 25 mm,
- b) where

i) the cladding above and below the joint is installed outboard of a drained and vented air space (see Clause 9.27.2.2.(1)(a)), and

ii) the horizontal detail is constructed so as to minimize the ingress of precipitation into the air space, or

c) at horizontal construction joints in stucco, where

i) the joint is finished with an expansion-contraction strip, and

ii) the cladding is installed outboard of a drained and vented air space (see Clause 9.27.2.2.(1)(a)).

3) Flashing shall be installed over exterior wall openings where the vertical distance from the bottom of the eave to the top of the trim is more than one-quarter of the horizontal overhang of the eave. (See Note A-9.27.3.8.(3).)

4) Flashing described in Sentences (1) and (3) shall

a) extend not less than 50 mm upward inboard of the sheathing membrane or sheathing installed in lieu of the sheathing membrane (see Article 9.27.3.4.),

b) have a slope of not less than 6% toward the exterior after the expected shrinkage of the *building* frame,

c) terminate at each end with an end-dam

i) with a height in millimetres not less than 25 mm or 1/10 the value of the 1-in-5 driving rain wind pressure in Pa, and

ii) at the height defined in Subclause (c)(i), extending to the face of the adjacent cladding,

d) lap not less than 10 mm vertically over the *building* element below, and

e) terminate in a drip offset not less than 5 mm outward from the outer face of the *building* element below.

(See Note A-9.27.3.8.(4).)

5) Where the sills of windows and doors installed in exterior walls are not self-flashing, flashing shall be installed between the underside of the window or door and the wall construction below. (See Note A-9.27.3.8.(5).)

## **9.27.4. Sealants**

### **9.27.4.1. Required Sealants**

1) Sealant shall be provided where required to prevent the entry of water into the structure.

2) Sealant shall be provided between masonry, siding or stucco and the adjacent door and window frames or trim, including sills, unless such locations are completely protected from the entry of rain.

3) Sealant shall be provided at vertical joints between different cladding materials unless the joint is suitably lapped or flashed to prevent the entry of rain. (See Articles 9.7.6.2., 9.20.13.12. and 9.28.1.5.)

### **9.27.4.2. Materials**

1) Sealants shall be

a) a non-hardening type suitable for exterior use,

b) selected for their ability to resist the effects of weathering, and

c) compatible with and adhere to the substrate to which they are applied.

(See Note A-9.27.4.2.(1).)

2) Sealants shall conform to

a) ASTM C834, "Standard Specification for Latex Sealants,"

b) ASTM C920, "Standard Specification for Elastomeric Joint Sealants,"

c) ASTM C1184, "Standard Specification for Structural Silicone Sealants," or

d) ASTM C1311, "Standard Specification for Solvent Release Sealants."

3) Backer rod shall conform to ASTM C1330, "Standard Specification for Cylindrical Sealant Backing for Use with Cold Liquid-Applied Sealants." (See Note A-9.27.4.2.(1).)

## **9.27.5. Attachment of Cladding**

### **9.27.5.1. Attachment**

1) Except as permitted by Sentences (2) to (5), cladding shall be fastened to the framing members or furring members, or to blocking between the framing members.

2) Vertical lumber, stucco lath or reinforcing, vertically applied vinyl siding, vertically applied insulated vinyl siding, and polypropylene siding are permitted to be attached to sheathing only where the sheathing consists of not less than

a) 14.3 mm lumber,

b) 12.5 mm plywood or waferboard, or

c) 11 mm OSB.

3) Vertically applied metal siding and wood shingles and shakes are permitted to be attached to the sheathing only where the sheathing consists of not less than

a) 14.3 mm lumber,

b) 7.5 mm plywood, or

c) 7.5 mm OSB or waferboard.

4) Where wood shingles or shakes are applied to sheathing which is not suitable for attaching the shingles or shakes, the shingles or shakes are permitted to be attached to a wood lath not less than 38 mm by 9.5 mm thick securely nailed to the framing and applied as described in Article 9.27.7.5.

5) Cladding, trim and furring members are permitted to be attached to the web fastening strips of flat wall insulating concrete form units using screws in accordance with Sentence 9.27.5.4.(2).

### **9.27.5.2. Blocking**

1) Blocking for the attachment of cladding shall be not less than 38 mm by 38 mm lumber securely nailed to the framing and spaced not more than 600 mm o.c.

### **9.27.5.3. Furring**

1) Except as permitted in Sentence 9.27.5.1.(4), furring for the attachment of cladding shall be not less than 19 mm by 38 mm lumber when applied over sheathing.

2) When applied without sheathing, furring referred to in Sentence (1) shall be not less than

a) 19 mm by 64 mm lumber on supports spaced not more than 400 mm o.c., or

- b) 19 mm by 89 mm lumber on supports spaced not more than 600 mm o.c.
- 3) Furring referred to in Sentence (1) shall be
  - a) securely fastened to the framing, and
  - b) spaced not more than 600 mm o.c.

**9.27.5.4. Size and Spacing of Fasteners**

1) Nail or staple size and spacing for the attachment of cladding and trim to wood framing, furring members or blocking shall conform to Table 9.27.5.4.-A.

**Table 9.27.5.4.-A**  
**Attachment of Cladding to Wood Framing, Furring Members or Blocking**  
**Forming Part of Sentence 9.27.5.4.(1)**

Type of Cladding	Minimum Nail or Staple Length, mm <sup>(1)</sup>	Minimum Number of Nails or Staples	Maximum Nail or Staple Spacing, mm o.c.
Wood trim	51	—	600
Lumber siding or horizontal siding made from sheet material	51	—	600
Metal cladding	38	—	600 (nailed to framing) 400 (nailed to sheathing only)
Wood shakes			
up to 200 mm in width	51	2	—
over 200 mm in width	51	3	—
Wood shingles			
up to 200 mm in width	32	2	—
over 200 mm in width	32	3	—
Vinyl and insulated vinyl siding			
horizontally applied	38	—	400 <sup>(2)</sup>
vertically applied	38	—	300
Polypropylene siding	38	—	400 <sup>(2)</sup>
Panel- or sheet-type cladding			
up to 7 mm thick	38	—	150 (along edges)
over 7 mm thick	51	—	300 (along intermediate supports)

**Notes to Table 9.27.5.4.-A:**

<sup>(1)</sup> The minimum fastener length need not exceed the minimum fastener penetration depth required by Article 9.27.5.7.

<sup>(2)</sup> The maximum spacing of 400 mm o.c. applies to nails and staples used to attach horizontally applied vinyl, insulated vinyl and polypropylene siding, unless a greater spacing is permitted in an evaluation report prepared by an accredited certification organization.

2) Screw size and spacing for the attachment of cladding, trim and furring members to the web fastening strips of flat wall insulating concrete form (ICF) units shall conform to

Table 9.27.5.4.-B where the 1-in-50 hourly wind pressure (HWP) is less than or equal to 0.60 kPa. (See Note A-9.27.5.4.(2).)

**Table 9.27.5.4.-B**  
**Attachment of Cladding to Flat Wall ICF Units where the 1-in-50 HWP ≤ 0.60 kPa**  
**Forming Part of Sentence 9.27.5.4.(2)**

Type of Cladding <sup>(1)</sup>	Minimum Screw Length	Minimum Screw Diameter, mm	Maximum Horizontal Spacing of Screws, mm o.c. <sup>(2)</sup>
Wood trim	<sup>(3)</sup>	3.5	400 or 450 (screwed to web fastening strip)
Lumber siding or horizontal siding made from sheet material	<sup>(3)</sup>	4.2	400 or 450 (screwed to web fastening strip)
Metal cladding	<sup>(3)</sup>	4.2	400 or 450 (screwed to web fastening strip)
Vinyl cladding	<sup>(3)</sup>	3.5	400 or 450 (screwed to web fastening strip)
Masonry veneer <sup>(4)</sup>	<sup>(3)</sup>	4.2	400 or 450 (masonry tie screwed to web fastening strip)
Panel- or sheet-type cladding			
up to 7 mm thick	<sup>(3)</sup>	3.5	150 or 200 (along edges)
over 7 mm thick	<sup>(3)</sup>	4.2	300 or 400 (along intermediate supports)

**Notes to Table 9.27.5.4.-B:**

<sup>(1)</sup> Wood shakes and wood shingles are permitted to be attached to horizontal wood furring members in accordance with Table 9.27.5.4.-A. The wood furring members shall be attached to the web fastening strips of flat wall ICF units with screws not less than 4.2 mm in diameter spaced horizontally not more than 400 or 450 mm o.c. (two horizontal spacing options are given to accommodate the 150 and 200 mm o.c. horizontal spacing options for web fastening strips).

<sup>(2)</sup> Two horizontal spacing options are given to accommodate the 150 mm o.c. and 200 mm o.c. horizontal spacing options for web fastening strips. The maximum vertical spacing of screws or masonry ties, as applicable, shall be 400 mm.

<sup>(3)</sup> Screws must be long enough to penetrate through the web fastening strips by a minimum of 6 mm.

<sup>(4)</sup> See also Subsection 9.20.5. for requirements on the support of masonry veneer.

**9.27.5.5. Fastener Materials**

1) Nails or staples for the attachment of cladding and wood trim shall be corrosion-resistant and shall be compatible with the cladding material.

**9.27.5.6. Expansion and Contraction**

1) Fasteners for metal cladding shall be positioned to permit expansion and contraction of the cladding.

2) Fasteners for vinyl siding, insulated vinyl siding and polypropylene siding shall be installed in the centre of the slots of the nail hem.

**9.27.5.7. Penetration of Fasteners**

(See Note A-9.27.5.7.)

1) Fasteners for shakes and shingles shall penetrate through the nail-holding base or not less than 19 mm into the framing.

2) Fasteners for vinyl cladding, insulated vinyl cladding and polypropylene cladding shall penetrate through the nail-holding base or not less than 32 mm into the framing.

3) Fasteners for cladding other than that described in Sentences (1) and (2) shall penetrate through the nail-holding base or not less than 25 mm into the framing.

### **9.27.6. Lumber Siding**

#### **9.27.6.1. Materials**

1) Lumber siding shall be sound, free of knot holes, loose knots, through checks or splits.

#### **9.27.6.2. Thickness and Width**

1) Drop, rustic, novelty, lapped board and vertical wood siding shall be not less than 14.3 mm thick and not more than 286 mm wide.

2) Bevel siding shall be

a) not less than 5 mm thick at the top, and

b) not less than

i) 12 mm thick at the butt for siding 184 mm or less in width, and

ii) 14.3 mm thick at the butt for siding wider than 184 mm.

3) Bevel siding shall be not more than 286 mm wide.

#### **9.27.6.3. Joints**

1) Lumber siding shall prevent water from entering at the joints by the use of lapped or matched joints or by vertical wood battens.

2) Siding shall overlap not less than 1 mm per 16 mm width of lumber, but not less than

a) 9.5 mm for matched siding,

b) 25 mm for lapped bevel siding, or

c) 12 mm for vertical battens.

### **9.27.7. Wood Shingles and Shakes**

#### **9.27.7.1. Materials**

1) Shingles and shakes shall conform to

a) CSA O118.1, "Western Red Cedar Shakes and Shingles," or

b) CSA O118.2, "Eastern White Cedar Shingles."

2) Western cedar shakes shall be not less than No. 1 or Handsplit grade, and western cedar shingles not less than No. 2 grade, except that No. 3 grade may be used for undercoursing.

3) Eastern white cedar shingles shall be at least B (clear) grade, except that C grade may be used for the lower course of double course applications.

#### **9.27.7.2. Width**

1) Shingles and shakes shall be not less than 65 mm or more than 350 mm wide.

#### **9.27.7.3. Fasteners**

1) Shingles or shakes shall be fastened with nails or staples located approximately 20 mm from each edge and not less than 25 mm above the exposure line for single-course applications, or approximately 50 mm above the butt for double-course applications.

#### **9.27.7.4. Offsetting of Joints**

1) In single-course application, joints in succeeding courses shall be offset not less than 40 mm so that joints in any 2 of 3 consecutive courses are staggered.

2) In double-course application, joints in the outer course shall be offset from joints in the under-course by not less than 40 mm, and joints in succeeding courses shall be offset not less than 40 mm.

**9.27.7.5. Fastening to Lath**

1) When lath is used with double-course application [see Sentence 9.27.5.1.(4)], it shall be spaced according to the exposure and securely fastened to the framing.

2) The butts of the under-course of the application referred to in Sentence (1) shall rest on the top edge of the lath.

3) The outer course of the application referred to in Sentence (1) shall be fastened to the lath with nails of sufficient length to penetrate through the lath.

4) The butts of the shingles or shakes shall be so located that they project not less than 12 mm below the bottom edge of the lath referred to in Sentence (1).

5) If wood lath is not used, the butts of the under-course shingles or shakes of the application referred to in Sentence (1) shall be located 12 mm above the butts of the outer course.

**9.27.7.6. Exposure and Thickness**

1) The exposure and butt thickness of shingles and shakes shall conform to Table 9.27.7.6.

**Table 9.27.7.6.**

**Exposure and Thickness of Wood Shingles and Shakes**

**Forming Part of Sentence 9.27.7.6.(1)**

Shake or Shingle Length, mm	Maximum Exposure, mm		Minimum Butt Thickness, mm
	Single Coursing	Double Coursing	
400	190	305	10
450	216	356	11
600	292	406	13

**9.27.8. Plywood**

**9.27.8.1. Material Standards**

- 1) Plywood cladding shall be exterior type conforming to
  - a) ANSI/HPVA HP-1, "American National Standard for Hardwood and Decorative Plywood,"
  - b) CSA O121, "Douglas fir plywood,"
  - c) CSA O151, "Canadian softwood plywood," or
  - d) CSA O153, "Poplar plywood."

**9.27.8.2. Thickness**

- 1) Plywood cladding shall be not less than 6 mm thick when applied directly to sheathing.
- 2) When applied directly to framing or over furring strips, plywood cladding thickness shall conform to Table 9.27.8.2.



Table 9.27.8.2.

**Minimum Plywood Cladding Thickness**

**Forming Part of Sentences 9.27.8.2.(2) and 9.27.10.2.(2)**

Spacing of Supports, mm	Minimum Thickness, mm	
	Face Grain Parallel to Supports	Face Grain Right Angles to Supports
400	8	6
600	11	8

3) The thickness of grooved or textured plywood cladding shall be measured at the point of least thickness.

**9.27.8.3. Edge Treatment**

1) The edges of plywood cladding shall be treated with a suitable paint or sealer.

**9.27.8.4. Panel Cladding**

1) Plywood applied in panels shall have all edges supported.

2) Not less than a 2 mm gap shall be provided between panels referred to in Sentence (1).

3) Vertical joints in cladding referred to in Sentence (1) shall be protected with batten strips or sealant when the plywood joints are not matched.

4) Horizontal joints in cladding referred to in Sentence (1) shall be lapped not less than 25 mm or shall be suitably flashed.

**9.27.8.5. Lapped Strip Siding**

1) Plywood applied in horizontal lapped strips shall have not less than a 2 mm gap provided at the butted ends, which shall be caulked.

2) The horizontal joints of siding described in Sentence (1) shall be lapped not less than 25 mm.

3) Wedges shall be inserted under all vertical butt joints and at all corners when horizontal lapped plywood is applied without sheathing.

**9.27.9. Hardboard**

**9.27.9.1. Material Standards**

1) Hardboard cladding shall conform to ANSI A135.6, "Engineered Wood Siding."

**9.27.9.2. Thickness**

1) Hardboard cladding shall be not less than

a) 9.5 mm thick when applied over sheathing that provides continuous support or over furring or framing members not more than 400 mm o.c., or

b) 11.1 mm thick when applied over furring or framing members not more than 600 mm o.c.

2) Where hardboard cladding is grooved, the grooves shall not extend more than 1.5 mm into the minimum required thickness. (See Note A-9.27.9.2.(2).)

**9.27.9.3. Panel Cladding**

1) Hardboard cladding applied in panels shall have all edges supported with not less than a 5 mm gap provided between sheets.

2) Vertical joints in cladding described in Sentence (1) shall be protected with batten strips or sealant when the joints are not matched.

3) Horizontal joints in cladding described in Sentence (1) shall be lapped not less than 25 mm or shall be suitably flashed.

#### **9.27.9.4. Lapped Strip Siding**

1) Hardboard applied in horizontal lapped strips shall have not less than a 5 mm gap provided at the butted ends, which shall be sealed or otherwise protected with suitable mouldings.

2) The horizontal joints of siding described in Sentence (1) shall overlap not less than 1 mm per 16 mm width of siding board but not less than 9.5 mm for matched joint siding or 25 mm for lapped siding.

#### **9.27.9.5. Clearance**

1) Not less than 3 mm clearance shall be provided between hardboard cladding and door or window frames.

### **9.27.10. OSB and Waferboard**

#### **9.27.10.1. Material Standard**

1) OSB and waferboard cladding shall conform to CSA O437.0, "OSB and Waferboard."

#### **9.27.10.2. Thickness**

1) OSB conforming to O-2 grade shall be not less than 6.0 mm thick where applied directly to sheathing.

2) OSB conforming to O-2 grade applied directly to framing or over furring strips shall conform to the thickness shown for plywood in Table 9.27.8.2. (See Note A-9.27.10.2.(2).)

3) OSB conforming to O-1 grade and waferboard conforming to R-1 grade shall be not less than 7.9 mm thick where applied directly to sheathing.

4) Where applied directly to framing or over furring strips, OSB conforming to O-1 grade and waferboard conforming to R-1 grade shall be not less than

a) 9.5 mm thick on supports spaced not more than 400 mm o.c., and

b) 12.7 mm thick on supports spaced not more than 600 mm o.c.

#### **9.27.10.3. Panel Cladding**

1) OSB and waferboard applied in panels shall have all edges supported and treated with a primer or sealer.

2) Not less than a 3 mm gap shall be provided between sheets in cladding described in Sentence (1).

3) Vertical joints in cladding described in Sentence (1) shall be protected with batten strips or sealant when the OSB and waferboard joints are not matched.

4) Horizontal joints in cladding described in Sentence (1) shall be lapped not less than 25 mm or shall be suitably flashed.

#### **9.27.10.4. Clearance**

1) Not less than a 3 mm clearance shall be provided between OSB and waferboard cladding and door or window frames.

## **9.27.11. Metal**

### **9.27.11.1. Material Standards**

1) Steel sheet cladding, including horizontal and vertical strip steel siding, flashing and trim accessories, shall

- a) have a minimum thickness of 0.33 mm, and
- b) conform to CSSBI 23M, "Standard for Residential Steel Cladding."

(See Note A-9.27.11.1.(1).)

2) Horizontal and vertical strip aluminum siding, including flashing and trim accessories, shall conform to CAN/CGSB-93.2-M, "Prefinished Aluminum Siding, Soffits, and Fascia, for Residential Use." (See Note A-9.27.11.1.(2) and (3).)

3) Aluminum sheet cladding shall conform to CAN/CGSB-93.1-M, "Sheet, Aluminum Alloy, Prefinished, Residential," and shall have a thickness of not less than 0.58 mm, except that siding supported by backing or sheathing shall have a thickness of not less than 0.46 mm. (See Note A-9.27.11.1.(2) and (3).)

## **9.27.12. Vinyl Siding, Insulated Vinyl Siding and Vinyl Soffits**

### **9.27.12.1. Material Standards**

1) Vinyl siding shall conform to ASTM D3679, "Standard Specification for Rigid Poly (Vinyl Chloride) (PVC) Siding."

2) Insulated vinyl siding shall conform to ASTM D7793, "Standard Specification for Insulated Vinyl Siding."

3) Rigid vinyl soffits shall conform to ASTM D4477, "Standard Specification for Rigid (Unplasticized) Poly(Vinyl Chloride) (PVC) Soffit."

4) Where vinyl siding, insulated vinyl siding or rigid vinyl soffits are required to have a *flame-spread rating*, the rating shall be determined in accordance with CAN/ULC-S102.2, "Standard Method of Test for Surface Burning Characteristics of Flooring, Floor Coverings, and Miscellaneous Materials and Assemblies."

### **9.27.12.2. Attachment**

1) The attachment of vinyl siding and insulated vinyl siding shall conform to the requirements in Subsection 9.27.5.

## **9.27.13. Polypropylene Siding**

### **9.27.13.1. Material Standard**

1) Polypropylene siding shall conform to ASTM D7254, "Standard Specification for Polypropylene (PP) Siding."

2) Where polypropylene siding is required to have a *flame-spread rating*, the rating shall be determined in accordance with CAN/ULC-S102.2, "Standard Method of Test for Surface Burning Characteristics of Flooring, Floor Coverings, and Miscellaneous Materials and Assemblies."

### **9.27.13.2. Attachment**

1) The attachment of polypropylene siding shall conform to the requirements in Subsection 9.27.5.

## **9.27.14. Exterior Insulation Finish Systems**

### **9.27.14.1. Application**

1) Except as provided in Sentence (2), this Subsection applies to exterior insulation finish systems (EIFS) that

a) are covered in the scope of CAN/ULC-S716.1, "Standard for Exterior Insulation and Finish Systems (EIFS) - Materials and Systems," and

b) have a geometrically defined drainage cavity with a minimum cavity depth of 9.5 mm and an open area equal to not less than 13% of the area of a full-size EIFS panel.

(See Note A-9.27.14.1.(1).)

2) EIFS that are not covered by Sentence (1) shall comply with Part 5.

### **9.27.14.2. Materials**

1) The materials used in EIFS shall conform to CAN/ULC-S716.1, "Standard for Exterior Insulation and Finish Systems (EIFS) - Materials and Systems."

2) The substrate on which the EIFS is installed shall

a) be compatible with that particular system (see Note A-9.27.14.2.(2)(a)), and

b) comply with the structural requirements for sheathing materials stated in Section 9.23.

### **9.27.14.3. Design and Installation**

1) The design and installation of EIFS on the substrate described in Sentence 9.27.14.2.(2) shall comply with

a) CAN/ULC-S716.2, "Standard for Exterior Insulation and Finish Systems (EIFS) - Installation of EIFS Components and Water Resistive Barrier," and

b) CAN/ULC-S716.3, "Standard for Exterior Insulation and Finish System (EIFS) - Design Application."

## **Section 9.28. Stucco**

### **9.28.1. General**

#### **9.28.1.1. Sheathing beneath Stucco**

1) Sheathing shall be provided beneath stucco applied over wood-frame walls except as permitted in Article 9.28.4.2.

2) Where applied beneath stucco, sheathing shall conform to Subsection 9.23.17.

#### **9.28.1.2. Lath and Reinforcing**

1) Stucco lath or reinforcing shall be used to attach stucco to any substrate other than masonry.

2) Stucco lath or reinforcing shall be used to attach stucco to masonry where

a) the masonry is soft-burned tile or brick of less strength than the stucco, or

b) the masonry surface is not sound, clean and sufficiently rough to provide a good key.

3) Stucco applied over masonry *chimneys* shall be reinforced.

#### **9.28.1.3. Concrete Masonry Units**

1) Stucco finish shall not be applied over concrete masonry units less than one month old unless the units have been cured by the autoclave process.

**9.28.1.4. Clearance over Ground Level**

1) Stucco shall be not less than 200 mm above finished ground level except when it is applied over concrete or masonry.

**9.28.1.5. Flashing and Caulking**

1) Flashing and caulking used with stucco shall conform to Subsections 9.27.3. and 9.27.4., except that if aluminum flashing is used, it shall be separated from the stucco by an impervious membrane or coating. (See Article 9.7.6.2. for caulking around window frames.)

**9.28.2. Stucco Materials**

**9.28.2.1. Portland Cement**

1) Portland cement shall conform to CSA A3001, "Cementitious Materials for Use in Concrete."

**9.28.2.2. Aggregate**

1) Aggregate shall be clean, well-graded natural sand or sand manufactured from crushed stone, gravel or air-cooled blast furnace slag and shall contain no significant amounts of deleterious material.

2) Aggregate grading shall conform to Table 9.28.2.2.

**Table 9.28.2.2.**

**Aggregate Grading for Stucco**

**Forming Part of Sentence 9.28.2.2.(2)**

Sieve Sizes, mm	% Aggregate Passing Sieve	
	Maximum	Minimum
4	—	100
2	—	90
1	90	60
0.5	60	45
0.25	30	10
0.125	5	—

**9.28.2.3. Water**

1) Water shall be clean and free of significant amounts of deleterious material.

**9.28.3. Fasteners**

**9.28.3.1. Materials**

1) Fasteners for stucco lath or reinforcing shall be corrosion-resistant and of a material other than aluminum.

**9.28.3.2. Nails and Staples**

1) Nails for stucco lath or reinforcing shall be not less than 3.2 mm diam with a head diameter of not less than 11.1 mm.

2) Staples for stucco lath or reinforcing shall be not less than 1.98 mm diam or thickness.

3) Staples and nails for attaching stucco lath or reinforcing to vertical surfaces shall be of sufficient length to penetrate 25 mm into framing members or to the full depth of the sheathing where the sheathing is used for attachment.

4) On horizontal surfaces nails for stucco lath or reinforcing shall be not less than 38 mm long.

**9.28.4. Stucco Lath**

**9.28.4.1. Materials**

- 1) Rib lath or expanded metal stucco mesh shall be
  - a) copper-alloy steel coated with rust-inhibitive paint after fabrication, or
  - b) galvanized.
- 2) Woven or welded wire mesh shall be galvanized.

**9.28.4.2. No Sheathing Required**

1) Sheathing need not be provided beneath stucco where not less than 1.19 mm diam galvanized wire is applied horizontally to the framing at vertical intervals of not more than 150 mm, or where paper-backed welded wire metal lath is used.

**9.28.4.3. Stucco Lath Specifications**

- 1) Stucco lath shall conform to Table 9.28.4.3.

**Table 9.28.4.3.**

**Stucco Lath**

**Forming Part of Sentence 9.28.4.3.(1)**

Location	Type of Lath	Minimum Diam of Wire, mm	Maximum Mesh Opening	Minimum Mass, kg/m <sup>2</sup>
Vertical surfaces	Welded or woven wire	1.15	25 mm	—
		1.30	38 mm	—
		1.50	51 mm	—
	Stucco mesh reinforcing (expanded metal)	—	25.8 cm <sup>2</sup>	0.98
Horizontal surfaces <sup>(1)</sup>	9.5 mm rib lath	—	—	1.84
	Cedar lath	—	—	—

Notes to Table 9.28.4.3.:

<sup>(1)</sup> See Note A-Table 9.28.4.3.

**9.28.4.4. Self-Furring Devices**

1) Stucco lath shall be held not less than 6 mm away from the backing by means of suitable self-furring devices.

**9.28.4.5. Application of Stucco Lath**

- 1) Stucco lath shall be applied with the long dimension horizontal.
- 2) Horizontal and vertical joints in stucco lath shall be lapped not less than 50 mm.
- 3) End joints of stucco lath shall be staggered and shall occur over framing members.

4) External corners of stucco lath shall be reinforced with a vertical strip of lath or reinforcing extending not less than 150 mm on both sides of the corner, or the lath or reinforcing shall extend around corners not less than 150 mm.

**9.28.4.6. Fastening**

- 1) Stucco lath shall be fastened in conformance with Subsection 9.27.5.
- 2) Fasteners on vertical surfaces shall be spaced not more than
  - a) 150 mm o.c. vertically and 400 mm o.c. horizontally, or
  - b) 100 mm o.c. vertically and 600 mm o.c. horizontally.
- 3) Nailing patterns other than those required in Sentence (2) are permitted to be used provided there are at least 20 fasteners per square metre of wall surface.
- 4) Fasteners on horizontal surfaces shall be spaced not more than
  - a) 150 mm o.c. along the framing members when members are spaced not more than 400 mm o.c., and
  - b) 100 mm o.c. along members when members are spaced not more than 600 mm o.c.

**9.28.5. Stucco Mixes**

**9.28.5.1. Mixes**

- 1) Stucco mixes shall conform to Table 9.28.5.1.

**Table 9.28.5.1.**

**Stucco Mixes**

**Forming Part of Sentence 9.28.5.1.(1)**

Materials, volume			
Portland Cement	Masonry Cement	Lime	Aggregate
1	—	0.25 to 1	3.25 to 4 parts per part of cementitious material
1	1	—	

**9.28.5.2. Pigments**

- 1) Pigment if used shall consist of pure mineral oxides inert to the action of sun, lime and cement.
- 2) Pigment shall not exceed 6% of the Portland cement by weight.

**9.28.5.3. Mixing**

- 1) Materials shall be thoroughly mixed before and after water is added.
- 2) Stucco shall be applied not later than 3 h after the initial mixing.

**9.28.6. Stucco Application**

**9.28.6.1. Low Temperature Conditions**

- 1) The base for stucco shall be maintained above freezing.
- 2) Stucco shall be maintained at a temperature of not less than 10°C during application, and for not less than 48 h afterwards.

**9.28.6.2. Number of Coats and Total Thickness**

1) Stucco shall be applied with at least 2 base coats and one finish coat, providing a total thickness of not less than 15 mm, measured from the face of the lath or the face of the masonry where no lath is used.

#### **9.28.6.3. First Coat**

- 1) The first coat shall be not less than 6 mm thick, measured from the face of the lath or masonry, fully embedding the lath.
- 2) The surface of the first coat shall be scored to provide a key with the second coat.

#### **9.28.6.4. Second Coat**

- 1) The second coat shall be not less than 6 mm thick.
- 2) The surface of the second coat shall be lightly roughened to provide a key with the finish coat if the finish coat is other than stone dash.

#### **9.28.6.5. Finish Coat**

- 1) When the finish coat is other than stone dash, the base shall be dampened but not saturated before the finish coat is applied.
- 2) The thickness of the finish coat shall be not less than 3 mm.
- 3) When a stone dash finish is used, the stone shall be partially embedded in the second coat before the second coat starts to set or stiffen.

## **Section 9.29. Interior Wall and Ceiling Finishes**

### **9.29.1. General**

#### **9.29.1.1. Fire Protection and Sound Control**

1) A wall or ceiling finish shall also conform to the appropriate requirements in Sections 9.10. and 9.11., in addition to the requirements in this Section.

### **9.29.2. Waterproof Wall Finish**

#### **9.29.2.1. Where Required**

- 1) Waterproof finish shall be provided to a height of not less than
  - a) 1.8 m above the floor in shower stalls,
  - b) 1.2 m above the rims of bathtubs equipped with showers, and
  - c) 400 mm above the rims of bathtubs not equipped with showers.

#### **9.29.2.2. Materials**

1) Waterproof finish shall consist of ceramic, plastic or metal tile, sheet vinyl, tempered hardboard, laminated thermosetting decorative sheets or linoleum.

### **9.29.3. Wood Furring**

#### **9.29.3.1. Size and Spacing of Furring**

1) Wood furring for the attachment of wall and ceiling finishes shall conform to Table 9.29.3.1.

**Table 9.29.3.1.**

**Size and Spacing of Furring  
Forming Part of Sentence 9.29.3.1.(1)**



Maximum Spacing of Furring, mm	Minimum Size of Furring, mm		
	Maximum Spacing of Furring Supports		
	Continuous Supports	400 mm o.c.	600 mm o.c.
300	19 × 38	19 × 38	19 × 64
400	19 × 38	19 × 38	19 × 64
600	19 × 38	19 × 64	19 × 89

### 9.29.3.2. Fastening

1) Furring shall be fastened to the framing or to wood blocks with not less than 51 mm nails.

### 9.29.4. Plastering

#### 9.29.4.1. Application

1) Application of plaster wall and ceiling finishes, including installation of metal or gypsum lath, shall conform to CSA A82.30-M, "Interior Furring, Lathing and Gypsum Plastering."

### 9.29.5. Gypsum Board Finish (Taped Joints)

#### 9.29.5.1. Application

1) The requirements for application of gypsum board in this Subsection apply to the single layer application of gypsum board to wood furring or framing using nails or screws.

2) Except as provided in Sentence (3), gypsum board applications not described in this Subsection shall conform to CSA A82.31-M, "Gypsum Board Application."

3) The application of gypsum board to flat insulating concrete form (ICF) walls shall conform to ASTM C840, "Standard Specification for Application and Finishing of Gypsum Board." (See Note A-9.29.5.1.(3).)

#### 9.29.5.2. Materials

1) Gypsum products shall conform to

a) ASTM C1178/C1178M, "Standard Specification for Coated Glass Mat Water-Resistant Gypsum Backing Panel," or

b) ASTM C1396/C1396M, "Standard Specification for Gypsum Board," except that the *flame-spread rating* of gypsum board shall be determined in accordance with CAN/ULC-S102, "Standard Method of Test for Surface Burning Characteristics of Building Materials and Assemblies."

#### 9.29.5.3. Maximum Spacing of Supports

1) Maximum spacing of supports for gypsum board applied as a single layer shall conform to Table 9.29.5.3.

Table 9.29.5.3.

### Spacing of Supports for Gypsum Board

#### Forming Part of Sentence 9.29.5.3.(1)

Thickness, mm	Orientation of Board to Framing	Maximum Spacing of Supports, mm o.c.		
		Walls	Ceilings	
			Painted Finish	Water-Based Texture Finish

Gypsum board conforming to Sentence 9.29.5.2.(1) (except Sections 9 and 12 of ASTM C1396/C1396M)				
9.5	parallel	—	—	—
	perpendicular	400	400	—
12.7	parallel	600	400	—
	perpendicular	600	600	400
15.9	parallel	600	400	—
	perpendicular	600	600	600
Gypsum ceiling board conforming to Clause 9.29.5.2.(1)(b) (only Section 12 of ASTM C1396/C1396M)				
12.7	parallel	600	400	—
	perpendicular	600	600	600

#### 9.29.5.4. Support of Insulation

- 1) Gypsum board supporting insulation shall be not less than 12.7 mm thick.

#### 9.29.5.5. Length of Fasteners

- 1) The length of fasteners for gypsum board shall conform to Table 9.29.5.5., except that lesser depths of penetration are permitted for assemblies required to have a *fire-resistance rating* provided it can be shown, on the basis of fire tests, that such depths are adequate for the required rating.

Table 9.29.5.5.

#### Fastener Penetration into Wood Supports

##### Forming Part of Sentence 9.29.5.5.(1)

Required <i>Fire-Resistance Rating</i> of Assembly	Minimum Penetration, mm			
	Walls		Ceilings	
	Nails	Screws	Nails	Screws
Not required	20	15	20	15
45 min	20	20	30	30
1 h	20	20	45	45
1.5 h	20	20	60	60

#### 9.29.5.6. Nails

- 1) Nails for fastening gypsum board to wood supports shall conform to
  - a) ASTM F1667, “Standard Specification for Driven Fasteners: Nails, Spikes, and Staples,” or
  - b) CSA B111, “Wire Nails, Spikes and Staples.”

#### 9.29.5.7. Screws

- 1) Screws for fastening gypsum board to wood supports shall conform to ASTM C1002, “Standard Specification for Steel Self-Piercing Tapping Screws for the Application of Gypsum Panel Products or Metal Plaster Bases to Wood Studs or Steel Studs.”

#### 9.29.5.8. Spacing of Nails

- 1) For single-layer application on a ceiling, nails shall be spaced

- a) not more than 180 mm o.c. on ceiling supports, or
  - b) every 300 mm o.c. along ceiling supports, in pairs about 50 mm apart.
- 2) Where the ceiling sheets are supported by the wall sheets around the perimeter of the ceiling, this support may be considered as equivalent to nailing at this location.
- 3) Except as required by Sentence (4), for single-layer application on walls, nails shall be spaced
- a) not more than 200 mm o.c. on vertical wall supports, or
  - b) every 300 mm o.c. along vertical wall supports, in pairs about 50 mm apart.
- 4) For single-layer application on walls, where gypsum board provides required bracing in *braced wall panels*, lateral support for studs, or fire protection, nails shall be spaced not more than 200 mm o.c. on
- a) vertical wall supports, and
  - b) top and bottom plates.
- (See Article 9.23.10.2. and Section 9.10.)
- 5) The uppermost nails on vertical wall supports shall be not more than 200 mm below the ceiling.
- 6) Nails shall be located not less than 10 mm from the side or edge of the board.
- 7) Nails shall be driven so that the heads do not puncture the paper.

#### **9.29.5.9. Spacing of Screws**

- 1) For single-layer application on a ceiling, screws shall be spaced not more than 300 mm o.c. on ceiling supports.
- 2) Where the ceiling sheets are supported by the wall sheets around the perimeter of the ceiling, this support may be considered as equivalent to screwing at this location.
- 3) Except as required by Sentence (4), for single-layer application on walls, screws shall be spaced
- a) not more than 300 mm o.c. on vertical wall supports where the supports are more than 400 mm o.c., or
  - b) not more than 400 mm o.c. on vertical wall supports where the supports are not more than 400 mm o.c.
- 4) Except as provided in Sentence (5), for single-layer application on walls, where gypsum board provides required bracing in *braced wall panels*, lateral support for studs, or fire protection, screws shall be spaced not more than 300 mm o.c. on
- a) vertical wall supports, and
  - b) top and bottom plates.
- (See Article 9.23.10.2. and Section 9.10.)
- 5) Where a *fire-resistance rating* is determined based on Table 9.10.3.1.-A, Sentence (4) need not apply for the purpose of fire protection.
- 6) Screws shall be located not less than 10 mm from the edge of the board.
- 7) Screws shall be driven so that the heads do not puncture the paper.

### 9.29.5.10. Low Temperature Conditions

1) In cold weather, heat shall be provided to maintain a temperature not below 10°C for 48 h prior to taping and finishing and maintained for not less than 48 h thereafter.

### 9.29.6. Plywood Finish

#### 9.29.6.1. Thickness

1) Except as provided in Sentences (2) and (3), the minimum thickness of plywood interior finish shall conform to Table 9.29.6.1.

Table 9.29.6.1.

Thickness of Plywood Interior Finish

#### Forming Part of Articles 9.29.6.1. and 9.29.6.2.

Maximum Spacing of Supports, mm o.c.	Minimum Thickness, mm <sup>(1)</sup>	
	On Supports with no Horizontal Blocking	On Supports with Blocking at Vertical Intervals not Exceeding 1.2 m
400	4.7	4.0
600	8.0	4.7

#### Notes to Table 9.29.6.1.:

<sup>(1)</sup> Thickness limits shall apply to the net effective thickness (NET) of grooved, striated, textured and/or embossed panels and to the actual thickness of flat panels.

2) A manufacturing tolerance of -0.4 mm may be applied to the thicknesses listed in Table 9.29.6.1.

3) No minimum thickness is required where plywood is applied over continuous backing.

#### 9.29.6.2. Grooved Plywood

1) Except as permitted in Sentence (2), where plywood for interior finish is grooved, the grooves shall not extend through the face ply and into the plies below the face ply unless the groove is supported by framing or furring.

2) If the grain of the face ply is at right angles to the supporting members, the groove is permitted to extend into plies below the face ply provided the thickness of the plywood exceeds the value shown in Table 9.29.6.1. by an amount equal to not less than the depth of penetration of the grooves into the plies below the face ply.

#### 9.29.6.3. Nails and Staples

1) Except as provided in Sentence (2), nails for attaching plywood finishes shall not be less than 38 mm casing or finishing nails spaced not more than 150 mm o.c. along edge supports and 300 mm o.c. along intermediate supports, except that staples providing equivalent lateral resistance may also be used.

2) Where plywood finish provides required bracing in *braced wall panels*, the plywood shall be fastened in accordance with the fastening requirements for sheathing stated in Sentence 9.23.3.5.(2).

#### 9.29.6.4. Edge Support

1) All plywood edges shall be supported by furring, blocking or framing.

### 9.29.7. Hardboard Finish

#### 9.29.7.1. Material Standard

- 1) Hardboard shall conform to CAN/CGSB-11.3-M, "Hardboard."

#### **9.29.7.2. Thickness**

- 1) Hardboard shall be not less than
  - a) 3 mm thick where applied over continuous backing,
  - b) 6 mm thick when applied over supports spaced not more than 400 mm o.c., and
  - c) 9 mm thick when applied over supports spaced not more than 600 mm o.c.

#### **9.29.7.3. Nails**

- 1) Nails for fastening hardboard shall be casing or finishing nails not less than 38 mm long, spaced not more than 150 mm o.c. along edge supports and 300 mm o.c. along intermediate supports.

#### **9.29.7.4. Edge Support**

- 1) All hardboard edges shall be supported by furring, blocking or framing where the backing is not continuous.

### **9.29.8. Insulating Fibreboard Finish**

#### **9.29.8.1. Material Standard**

- 1) Insulating fibreboard shall conform to CAN/ULC-S706.1, "Standard for Wood Fibre Insulating Boards for Buildings."

#### **9.29.8.2. Thickness**

- 1) Insulating fibreboard sheets shall be not less than 11.1 mm thick on supports not more than 400 mm o.c.
- 2) Insulating fibreboard tile shall be not less than 12.7 mm thick on supports spaced not more than 400 mm o.c.

#### **9.29.8.3. Nails**

- 1) Nails for fastening fibreboard sheets shall be not less than 2.6 mm shank diameter casing or finishing nails of sufficient length to penetrate not less than 20 mm into the supports.
- 2) Nails shall be spaced not more than 100 mm o.c. along edge supports and 200 mm o.c. along intermediate supports.

#### **9.29.8.4. Edge Support**

- 1) All fibreboard edges shall be supported by blocking, furring or framing.

### **9.29.9. Particleboard, OSB or Waferboard Finish**

#### **9.29.9.1. Material Standard**

- 1) Particleboard finish shall conform to ANSI A208.1, "Particleboard."
- 2) OSB or waferboard finish shall conform to
  - a) CSA O325, "Construction sheathing," or
  - b) CSA O437.0, "OSB and Waferboard."

#### **9.29.9.2. Minimum Thickness**

- 1) Except as provided in Sentences (2) and (3), the minimum thickness of O-2 grade OSB used as an interior finish shall conform to that shown for plywood in Table 9.29.6.1.

- 2) Thicknesses listed in Table 9.29.6.1. shall permit a manufacturing tolerance of  $-0.4$  mm.
- 3) No minimum thickness is required where O-2 grade OSB is applied over continuous backing.
- 4) OSB conforming to O-1 grade, waferboard conforming to R-1 grade and particleboard shall be
  - a) not less than 6.35 mm thick on supports not more than 400 mm o.c.,
  - b) not less than 9.5 mm thick on supports not more than 600 mm o.c., and
  - c) not less than 6.35 mm thick on supports not more than 600 mm o.c. in walls where blocking is provided at midwall height.
- 5) OSB conforming to CSA O325, "Construction sheathing," shall meet the minimum panel mark of
  - a) W16, on supports not more than 400 mm o.c.,
  - b) W24, on supports not more than 600 mm o.c., and
  - c) W16, on supports not more than 600 mm o.c. where blocking is provided at mid-wall height.

#### **9.29.9.3. Nails**

- 1) Except as provided in Sentence (2), nails for fastening particleboard, OSB or waferboard shall be not less than 38 mm casing or finishing nails spaced not more than 150 mm o.c. along edge supports and 300 mm o.c. along intermediate supports.
- 2) Where OSB or waferboard provides required bracing in *braced wall panels*, the OSB or waferboard shall be fastened in accordance with the fastening requirements for sheathing stated in Sentence 9.23.3.5.(2).

#### **9.29.9.4. Edge Support**

- 1) All particleboard, OSB or waferboard edges shall be supported by furring, blocking or framing.

### **9.29.10. Wall Tile Finish**

#### **9.29.10.1. Tile Application**

- 1) Ceramic tile shall be set in a mortar base or applied with an adhesive.
- 2) Plastic tile shall be applied with an adhesive.

#### **9.29.10.2. Mortar Base**

- 1) When ceramic tile is applied to a mortar base the cementitious material shall consist of one part Portland cement to not more than one-quarter part lime by volume.
- 2) The cementitious material described in Sentence (1) shall be mixed with not less than 3 nor more than 5 parts of aggregate per part of cementitious material by volume.
- 3) Mortar shall be applied over metal lath or masonry.
- 4) Ceramic tile applied to a mortar base shall be thoroughly soaked and pressed into place forcing the mortar into the joints while the tile is wet.

#### **9.29.10.3. Adhesives**

1) Adhesives to attach ceramic and plastic tile shall be applied to the finish coat or brown coat of plaster that has been steel-trowelled to an even surface or to gypsum board or to masonry provided the masonry has an even surface.

#### **9.29.10.4. Moisture-Resistant Backing**

1) Ceramic and plastic tile installed on walls around bathtubs or showers shall be applied over moisture-resistant backing.

#### **9.29.10.5. Joints between Tiles and Bathtub**

1) The joints between wall tiles and a bathtub shall be suitably caulked with material conforming to CAN/CGSB-19.22-M, "Mildew-Resistant Sealing Compound for Tubs and Tiles."

## **Section 9.30. Flooring**

### **9.30.1. General**

#### **9.30.1.1. Required Finished Flooring**

1) Finished flooring shall be provided in all *residential occupancies*.

#### **9.30.1.2. Water Resistance**

1) Where water permeable finished flooring in bathrooms, kitchens, public entrance halls and laundry areas is supported by a subfloor of a type that would be damaged by water, such flooring shall be installed over a membrane with a water permeance not exceeding 18 ng/(Pa×s×m<sup>2</sup>) when tested in accordance with ASTM E96/E96M, "Standard Test Methods for Water Vapor Transmission of Materials." (See Note A-9.30.1.2.(1).)

#### **9.30.1.3. Sleepers**

1) Wood sleepers supporting finished flooring over a concrete base supported on the ground shall be not less than 19 mm by 38 mm and shall be treated with a wood preservative.

#### **9.30.1.4. Finish Quality**

1) Finished flooring shall have a surface that is smooth, even and free from roughness or open defects.

### **9.30.2. Panel-Type Underlay**

#### **9.30.2.1. Required Underlay**

1) A panel-type underlay shall be provided under resilient flooring, parquet flooring, ceramic tile, felted-synthetic-fibre floor coverings or carpeting laid over lumber subflooring. (See Sentence 9.30.3.2.(1).)

2) Panel-type underlay shall be provided under resilient flooring, parquet flooring, felted-synthetic-fibre floor coverings or carpeting on panel-type subflooring whose edges are unsupported. (See Article 9.23.15.3.)

3) Panel-type underlay shall be provided under ceramic tile applied with adhesive.

#### **9.30.2.2. Materials and Thickness**

1) Panel-type underlay shall be not less than 6 mm thick and shall conform to

a) ANSI A208.1, "Particleboard,"

b) CAN/CGSB-11.3-M, "Hardboard,"

c) ANSI/HPVA HP-1, "American National Standard for Hardwood and Decorative Plywood,"

- d) CSA O121, "Douglas fir plywood,"
  - e) CSA O151, "Canadian softwood plywood,"
  - f) CSA O153, "Poplar plywood," or
  - g) CSA O437.0, "OSB and Waferboard."
- 2) Panel-type underlay under ceramic tile applied with adhesive shall be not less than
- a) 6 mm thick where the supports are spaced up to 300 mm o.c., and
  - b) 11 mm thick where the supports are spaced wider than 300 mm o.c.

**9.30.2.3. Fastening**

1) Panel-type underlay shall be fastened to the subfloor with staples, annular grooved flooring nails or spiral nails, spaced not more than 150 mm o.c. along the edges and 200 mm o.c. both ways at other locations.

2) Nails for panel-type underlay shall be not less than 19 mm long for 6 mm thick underlay and 22 mm long for 7.9 mm thick underlay.

3) Staples for panel-type underlay shall

- a) have not less than a 1.2 mm shank diameter or thickness with a 4.7 mm crown, and
- b) be not less than
  - i) 22 mm long for 6 mm underlay, and
  - ii) 28 mm long for 7.9 mm and 9.5 mm underlay.

**9.30.2.4. Joints Offset**

1) Where panel-type underlay is required to be installed over plywood, OSB or waferboard, the joints in the underlay shall be offset not less than 200 mm from the joints in the underlying subfloor.

**9.30.2.5. Surface Defects**

1) Underlay beneath resilient or ceramic floors applied with an adhesive shall have all holes or open defects on the surface patched so that the defects will not be transmitted to the finished surface.

**9.30.3. Wood Strip Flooring**

**9.30.3.1. Thickness**

1) The thickness of wood strip flooring shall conform to Table 9.30.3.1.

**Table 9.30.3.1.**

**Thickness of Wood Strip Flooring  
Forming Part of Sentence 9.30.3.1.(1)**

Type of Flooring	Max. Joist Spacing, mm	Minimum Thickness of Flooring, mm	
		With Subfloor	No Subfloor
Matched hardwood	400	7.9	19.0
(interior use only)	600	7.9	33.3
Matched softwood	400	19.0	19.0
(interior or exterior use)	600	19.0	31.7



Square edge softwood	400	—	25.4
(exterior use only)	600	—	38.1

### 9.30.3.2. Strip Direction and End Joints

- 1) Wood strip flooring shall not be laid parallel to lumber subflooring unless a separate underlay is provided.
- 2) If wood strip flooring is applied without a subfloor, it shall be laid at right angles to the joists so that the end joints are staggered and occur over supports or are end matched.
- 3) If the flooring is end matched, it shall be laid so that no 2 adjoining strips break joints in the same space between supports and each strip bears on no fewer than 2 supports.

### 9.30.3.3. Nailing

- 1) When nails are used, wood strip flooring shall be toe nailed or face nailed with not less than one nail per strip at the spacings shown in Table 9.30.3.3., except that face nailed strips more than 25 mm in width shall have at least 2 nails per strip.

**Table 9.30.3.3.**

#### Nailing of Wood Strip Flooring

##### Forming Part of Sentence 9.30.3.3.(1)

Finish Floor Thickness, mm	Minimum Length of Flooring Nails, mm	Maximum Spacing of Flooring Nails, mm
7.9	38 <sup>(1)</sup>	200
11.1	51	300
19.0	57	400
25.4	63	400
31.7	70	600
38.1	83	600

**Notes to Table 9.30.3.3.:**

<sup>(1)</sup> See Article 9.30.3.4.

- 2) Face nails shall be countersunk.

### 9.30.3.4. Staples

- 1) Staples are permitted to be used to fasten wood strip flooring not more than 7.9 mm in thickness provided the staples are not less than 29 mm long with a shank diameter of 1.19 mm and with 4.7 mm crowns.

## 9.30.4. Parquet Flooring

### 9.30.4.1. Adhesive

- 1) Adhesive used to attach parquet block flooring shall be suitable for bonding wood to the applicable subfloor material.

## 9.30.5. Resilient Flooring

### 9.30.5.1. Materials

- 1) Resilient flooring used on concrete slabs supported on ground shall consist of asphalt, rubber, unbacked vinyl or vinyl with an inorganic type backing.

2) Flooring described in Sentence (1) shall be attached to the base with a suitable waterproof and alkali-resistant adhesive.

### **9.30.6. Ceramic Tile**

#### **9.30.6.1. Substrate**

1) Ceramic tile shall be set in a mortar bed or applied to a sound smooth base with a suitable adhesive.

2) Panel-type subfloor to which ceramic tile is to be applied with adhesive shall have its edges supported according to Article 9.23.15.3.

## **Section 9.31. Plumbing Facilities**

### **9.31.1. Scope**

#### **9.31.1.1. Application**

1) This Section applies to the plumbing facilities and *plumbing systems* within *dwelling units*.

2) In *occupancies* other than *dwelling units*, plumbing facilities, grab bars, floor drains, and floor and wall finishes around urinals shall conform to Subsection 3.7.2. (See also Section 3.8. regarding *accessible* plumbing facilities.)

3) Medical gas piping systems shall conform to Subsection 3.7.3.

4) Systems used for service water heating shall conform to the energy efficiency requirements in Section 9.36.

### **9.31.2. General**

#### **9.31.2.1. General**

1) The construction, extension, *alteration*, renewal or repair of *plumbing systems* and sewage disposal systems shall conform to Part 7.

#### **9.31.2.2. Corrosion Protection**

1) Metal pipes in contact with cinders or other corrosive material shall be protected by a heavy coating of bitumen or other corrosion protection.

#### **9.31.2.3. Grab Bars**

1) When provided, grab bars shall be capable of resisting a load of not less than 1.3 kN applied vertically or horizontally.

#### **9.31.2.4. Site Constructed Fixtures**

1) A shower door that swings on a vertical axis shall be capable of opening outwards from a shower stall forming part of a site constructed fixture.

### **9.31.3. Water Supply and Distribution**

#### **9.31.3.1. Required Water Supply**

1) Every *dwelling unit* shall be supplied with potable water.

#### **9.31.3.2. Required Connections**

1) Where a piped water supply is available, piping for hot and cold water shall be connected to every kitchen sink, lavatory, bathtub, shower, slop sink and laundry area.

2) Piping for cold water shall be run to every water closet.

## **9.31.4. Required Facilities**

### **9.31.4.1. Required Fixtures**

1) A kitchen sink, lavatory, bathtub or shower, and water closet shall be provided for every *dwelling unit* where a piped water supply is available.

### **9.31.4.2. Hot Water Supply**

1) Where a piped water supply is available a hot water supply shall be provided in every *dwelling unit*.

### **9.31.4.3. Floor Drains**

1) Where gravity drainage to a sewer, drainage ditch or dry well is possible, a floor drain shall be installed in a *basement* forming part of a *dwelling unit*.

2) A floor drain shall be provided in a garbage room, incinerator room or *boiler* room serving more than one *dwelling unit*.

## **9.31.5. Sewage Disposal**

### **9.31.5.1. Building Sewer**

1) Wastes from every plumbing fixture shall be piped to the *building* sewer.

### **9.31.5.2. Discharge of Sewage**

1) *Building* sewers shall discharge into a public sewage system where such system is available.

2) Where a public sewage system is not available, the *building* sewer shall discharge into a *private sewage disposal system*.

## **9.31.6. Service Water Heating Facilities**

### **9.31.6.1. Hot Water Supply**

1) Where hot water is required to be supplied in accordance with Article 9.31.4.2., equipment shall

- a) provide an adequate supply of hot water, and
- b) be installed in conformance with Part 7.

### **9.31.6.2. Equipment and Installation**

1) *Service water heaters* shall conform to appropriate provincial or territorial requirements or, in the absence of such requirements, to the NPC.

2) The installation of *service water heaters*, including provisions for mounting, clearances and air supply, shall conform to

- a) the Safety Standards Act and pursuant regulations,
- b) CSA B139 Series, "Installation code for oil-burning equipment,"
- c) reserved,
- d) CSA B365, "Installation Code for Solid-Fuel-Burning Appliances and Equipment," or
- e) a combination thereof.

n3) Where the *building* is in a location where the seismic design parameter,  $S_{max}$ , for Site Class C is greater than 0.37, *service water heaters* shall be secured to the structure to prevent overturning. (See Note A-9.31.6.2.(3).)

#### **9.31.6.3. Corrosion-Resistant Coating**

1) Where storage tanks for *service water heaters* are of steel, they shall be coated with zinc, vitreous enamel (glass lined), hydraulic cement or other corrosion-resistant material.

#### **9.31.6.4. Fuel-Burning Heaters**

1) Fuel-burning *service water heaters* shall be connected to a *chimney flue* conforming to Section 9.21.

#### **9.31.6.5. Heating Coils**

1) Heating coils of *service water heaters* shall not be installed in a *flue* or in the combustion chamber of a *boiler* or *furnace* heating a *building*.

## **Section 9.32. Ventilation**

### **9.32.1. General**

#### **9.32.1.1. Application**

1) Except as required by Article 9.32.4.2., this Section applies to the ventilation of rooms and spaces in *residential occupancies* by natural ventilation and to self-contained mechanical ventilation systems serving only

- a) one *dwelling unit*, or
- b) a house with a *secondary suite* including their common spaces.

2) Mechanical ventilation systems other than self-contained systems serving a single *dwelling unit* or a house with a *secondary suite* including their common spaces shall conform to Part 6.

3) A *storage garage* for more than 5 motor vehicles shall be ventilated in accordance with Part 6.

4) Systems used for ventilation shall conform to the energy efficiency requirements in Part 10.

#### **9.32.1.2. Required Ventilation**

1) Every *dwelling unit* shall incorporate

- a) provisions for non-heating-season ventilation in accordance with Subsection 9.32.2., and
- b) except as required by Sentences (2) and (3), if supplied with electrical power, provisions for heating-season ventilation in accordance with Subsection 9.32.3.

2) A self-contained heating-season ventilation system serving a single *dwelling unit* or a single detached house shall comply with Subsection 9.32.3. (See Note A-9.32.1.2.(2).)

3) In single detached houses, heating-season ventilation need not be provided for

- a) *exits*,
- b) *public corridors*, and
- c) ancillary spaces that are not within a *dwelling unit*, except as provided in Sentence (4).

(See Note A-9.32.1.2.(2).)

4) Where ancillary spaces described in Clause (3)(c) contain exhaust devices, these spaces shall be provided with make-up air in accordance with Article 9.32.4.

**9.32.1.3. Venting of Laundry-Drying Equipment**

1) *Exhaust ducts* or vents connected to laundry-drying equipment shall discharge directly to the outdoors.

2) *Exhaust ducts* connected to laundry-drying equipment shall be

- a) independent of other *exhaust ducts*,
- b) accessible for cleaning, and
- c) constructed of a smooth corrosion-resistant material.

(See Note A-9.32.1.3.(2).)

3) Where collective venting of multiple installations of laundry-drying equipment is used, the ventilation system shall

- a) be connected to a common *exhaust duct* that is vented by one central exhaust fan,
- b) include an interlock to activate the central exhaust fan when laundry-drying equipment is in use, and
- c) where required by Article 9.32.4.1., be provided with make-up air.

**9.32.2. Non-Heating-Season Ventilation**

**9.32.2.1. Required Ventilation**

1) Rooms or spaces in *dwelling units* shall be ventilated during the non-heating season by

- a) natural ventilation in accordance with Article 9.32.2.2., or
- b) a mechanical ventilation system in accordance with Article 9.32. 3.

2) Where a habitable room or space is not provided with natural ventilation as described in Clause (1)(a), mechanical ventilation shall be provided to exhaust inside air from, or to introduce outside air to, that room or space at the rate of

- a) one-half air change per hour if the room or space is mechanically cooled during the non-heating season, or
- b) one air change per hour if the room or space is not mechanically cooled during the non-heating season.

**9.32.2.2. Non-Heating-Season Natural Ventilation**

1) The unobstructed openable ventilation area to the outdoors for rooms and spaces in residential *buildings* ventilated by natural means shall conform to Table 9.32.2.2.

**Table 9.32.2.2.**

**Natural Ventilation Area**

**Forming Part of Sentence 9.32.2.2.(1)**

Location		Minimum Unobstructed Area
Within a <i>dwelling unit</i>	Bathrooms or water-closet rooms	0.09 m <sup>2</sup>
	Unfinished <i>basement</i> space	0.2% of the <i>floor area</i>

	Dining rooms, living rooms, bedrooms, kitchens, combined rooms, dens, recreation rooms and all other finished rooms	0.28 m <sup>2</sup> per room or combination of rooms
Other than within a <i>dwelling unit</i>	Bathrooms or water-closet rooms	0.09 m <sup>2</sup> per water closet
	Sleeping areas	0.14 m <sup>2</sup> per occupant
	Laundry rooms, kitchens, recreation rooms	4% of the <i>floor area</i>
	Corridors, storage rooms and other similar public rooms or spaces	2% of the <i>floor area</i>
	Unfinished <i>basement</i> space not used on a shared basis	0.2% of the <i>floor area</i>

2) Where a vestibule opens directly off a living or dining room within a *dwelling unit*, ventilation to the outdoors for such rooms may be through the vestibule.

3) Openings for natural ventilation other than windows shall provide protection from the weather and insects.

4) Screening shall be of corrosion-resistant material.

### **9.32.2.3. Reserved**

## **9.32.3. Heating-Season Mechanical Ventilation**

(See Note A-9.32.3.)

### **9.32.3.1. Required Ventilation**

1) Every *dwelling unit* that is supplied with electrical power shall be provided by a mechanical ventilation system that conforms to

- a) CAN/CSA-F326-M, "Residential Mechanical Ventilation Systems,"
- b) this Subsection, or
- c) for ducted mechanical ventilation systems serving more than one *dwelling unit* in a single detached house, the mechanical ventilation system shall comply with this Subsection or Part 6.

(See Note A-9.32.3.1.(1).)

### **9.32.3.2. Design and Installation**

1) Aspects of mechanical ventilation systems not specifically described in this Subsection shall be designed, constructed and installed in accordance with good practice such as that described in the ASHRAE Handbooks and Standards, the HRAI Digest, the HRAI Residential Mechanical Ventilation Manual, the Hydronics Institute Manuals and the SMACNA Manuals.

2) Exhaust fans and supply fans shall be installed in accordance with this Subsection and the manufacturer's instructions .

3) The mechanical components of a mechanical ventilation system shall be installed so as to be accessible for inspection, maintenance, repair, and cleaning.

4) In a single detached house, where a heating or ventilation system serves more than a single *dwelling unit*, the system shall be designed and installed to prevent the circulation of smoke upon a signal from a duct-type *smoke detector*. (See Note A-9.32.3.2.(4).)

5) Except as provided in Sentence 9.10.9.9.(6), ducts penetrating *fire separations* shall be equipped with *fire dampers* in conformance with Article 3.1.8.10.

### **9.32.3.3. Mechanical Ventilation System Components**

- 1) A mechanical ventilation system shall include:
  - a) a principal ventilation fan system that
    - i) provides supply air in accordance with Article 9.32.3.4., and
    - ii) includes an exhaust fan that conforms with Article 9.32.3.5.,
  - b) the kitchen and bathroom exhaust fans that are required by Article 9.32.3.6., and
  - c) if the *building* includes a heated crawl space, the components that are required by Article 9.32.3.7.

### **9.32.3.4. Ventilation System Supply Air**

(See Note A-9.32.3.4.)

- 1) Except as provided in Sentence (6), a principal ventilation system shall mechanically provide supply air in accordance with Sentence (2), (3), (4) or (5).
- 2) Where the principal ventilation system is a ducted forced-air heating system, the ducted forced-air heating system shall
  - a) provide supply air through the ducting to
    - i) each bedroom,
    - ii) each floor level without a bedroom, and
    - iii) ancillary spaces that contain an exhaust device, where the space is not within a *dwelling unit* in a single detached house and where the house contains a fuel-fired *space-heating appliance* or fuel-fired water-heating *appliance* of other than *direct-vented* or *mechanically vented* types,
  - b) draw supply air from an outdoor inlet that is connected to the cabinet containing the furnace air circulating fan required by Clause (d) by ducting that measures, from that cabinet to the point at which the ducting intersects the return air plenum,
    - i) between 3 m and 4.5 m in length, or
    - ii) if a flow control device is used, not more than 4.5 m in length,
  - c) draw supply air through ducting that is
    - i) rigid ducting with an equivalent diameter of at least 100 mm, or
    - ii) flexible ducting with an equivalent diameter of at least 125 mm, and
  - d) have a furnace air circulating fan set to run continuously.
- 3) Where the principal ventilation system is a ducted forced-air heating system used in combination with a heat-recovery ventilator,
  - a) the ducted forced-air heating system shall conform to Clauses (2)(a),(c) and (d),
  - b) the heat-recovery ventilator shall draw supply air from an outdoor inlet into the return air plenum of the ducted forced-air heating system, and
  - c) the heat-recovery ventilator shall draw exhaust air, through dedicated ducting,
    - i) from one or more indoor inlets, at least one of which is located at least 2 m above the floor of the uppermost floor level, and

ii) at the capacity rating of the heat-recovery ventilator, which shall be no less than the air-flow rate specified in Table 9.32.3.5.

4) Where the principal ventilation system is a heat-recovery ventilator, the heat-recovery ventilator shall

a) provide supply air through dedicated ducting to

i) each bedroom,

ii) each floor level without a bedroom, and

iii) each ancillary space described in Subclause (2)(a)(iii), and

b) draw exhaust air, through dedicated ducting,

i) from one or more indoor inlets, at least one of which is located at least 2 m above the floor of the uppermost floor level, and

ii) at the capacity rating of the heat-recovery ventilator, which shall be no less than the air-flow rate specified in Table 9.32.3.5.5) Where the principal ventilation system is a ducted central-recirculation ventilation system, the ducted central-recirculation ventilation system shall

a) draw supply air from an outdoor inlet connected upstream of the fan,

b) draw air from

i) each bedroom and deliver it to a common area, or

ii) a common area and deliver it to each bedroom, and

c) deliver air to each ancillary space described in Subclause (2)(a)(iii).

6) A principal ventilation system need not conform to Sentence (1) if the principal ventilation system

a) services a *dwelling unit* that

i) is located where the January design temperature, on a 2.5% basis determined in conformance with Article 1.1.3.1., is greater than  $-20^{\circ}\text{C}$ ,

ii) has only 1 *storey* and a *floor area* of less than 168 m<sup>2</sup> within the *building* envelope (see Note A-9.32.3.4.(6)(a)(ii)),

iii) does not have a ducted forced-air heating system, and

iv) except for a *secondary suite*, is not located in a *building* conforming to Subsection 9.36.6. or 10.2.3., and

b) provides supply air passively from outdoors through dedicated inlets that

i) are located in each bedroom, at least one common area and each ancillary space described in Subclause (2)(a)(iii),

ii) are located at least 1 800 mm above the floor, and

iii) have an unobstructed vent area of not less than 25 cm<sup>2</sup>.

### **9.32.3.5. Principal Ventilation System Exhaust Fan**

1) A principal ventilation system exhaust fan shall

a) run continuously, and

b) provide at least the air-flow rate specified in Table 9.32.3.5.



**Table 9.32.3.5.**  
**Principal Ventilation System Exhaust Fan Minimum Air-flow Rate**  
**Forming Part of Clause 9.32.3.5.(1)**

Floor Area, m <sup>2</sup>	Minimum Air-flow Rate, L/s				
	Number of Bedrooms				
	0-1	2-3	4-5	6-7	> 7
< 140	14	21	28	35	42
140-280	21	28	35	42	49
281-420	28	35	42	49	56
421-560	35	42	49	56	64
561-700	42	49	56	64	71
> 700	49	56	64	71	78

2) For the purposes of Sentence (1), the capacity rating of the principal ventilation system exhaust fan shall be determined, based on air-flow performance at 50 pa of external static pressure, in accordance with

- a) HVI Publication 916, "Airflow Test Procedure," or
- b) CAN/CSA-C260-M, "Rating the Performance of Residential Mechanical Ventilating Equipment."

3) The principal ventilation system exhaust fan shall be

- a) designed to run continuously, and
- b) controlled by a dedicated switch that
  - i) has 2 settings, on and off,
  - ii) is located where it will be accessible for the purposes of servicing the exhaust fan but not likely to be turned off inadvertently, and
  - iii) is clearly marked "PRINCIPAL VENTILATION EXHAUST FAN."

4) If the principal ventilation system exhaust fan is designed to run at multiple air-flow rates,

- a) the air-flow rate of the fan shall be controlled by a switch other than the switch described in Clause (3)(b), and
- b) the lowest air-flow rate shall not be less than the air-flow rate specified in Table 9.32.3.5.

5) The sound rating of the principal ventilation system exhaust fan shall not exceed 1.0 sone when running continuously at the air-flow rate specified in Table 9.32.3.5. as determined in accordance with

- a) HVI Publication 915, "Loudness Testing and Rating Procedure," or
- b) CAN/CSA-C260-M, "Rating the Performance of Residential Mechanical Ventilating Equipment."

**9.32.3.6. Kitchen and Bathroom Exhaust Fans**

1) An exhaust fan that provides at least the air-flow rate specified in Table 9.32.3.6. shall be installed in

- a) every kitchen, and
  - b) every bathroom or water-closet room, unless the bathroom or water-closet room is served by the principal ventilation system exhaust fan that complies with Article 9.32.3.5.
- 2) For the purposes of Sentence (1), the capacity rating of the exhaust fan shall be determined, based on air-flow performance at 50 pa of external static pressure, in accordance with
- a) HVI Publication 916, "Airflow Test Procedure," or
  - b) CAN/CSA-C260-M, "Rating the Performance of Residential Mechanical Ventilating Equipment."

**Table 9.32.3.6.**  
**Kitchen/Bathroom Exhaust Fan Minimum Air-flow Rate**  
**Forming Part of Sentence 9.32.3.6.(1)**

Room	Minimum Exhaust Fan Air-flow Rate, L/s	
	Intermittent	Continuous
Kitchen	47	N/A
Bathroom	23	9

**9.32.3.7. Heated Crawl Space Ventilation**

- 1) Where a crawl space is heated by a ducted forced-air heating system that does not draw air from the crawl space to the furnace through the return air plenum, the crawl space shall be connected to the floor space above the crawl space by at least one air-transfer grille.
- 2) Where a crawl space is heated other than by a ducted forced-air heating system, the crawl space shall
- a) be connected to
    - i) the floor space above the crawl space by at least one air-transfer grille, and
    - ii) the principal ventilation system by a supply air outlet or an exhaust air inlet,
  - b) be connected to the floor space above the crawl space by at least 2 air-transfer grilles for every 30 m<sup>2</sup> of crawl space area, or
  - c) be connected to
    - i) the floor space above the crawl space by at least one air-transfer grille, and
    - ii) the outdoors by a dedicated exhaust fan that complies with Sentence (4).
- 3) An air-transfer grille required by Sentence (1) or (2) shall have an unobstructed vent area of the greater of
- a) 25 cm<sup>2</sup>, and
  - b) 0.83 cm<sup>2</sup> for every m<sup>2</sup> of crawl space area.
- 4) Where a dedicated exhaust fan is installed in accordance with Subclause (2)(c)(ii), the dedicated exhaust fan shall
- a) provide an air-flow rate of at least 23 L/s, and

- b) be controlled by
  - i) a humidity control device, or
  - ii) an adjustable time control device that is capable of providing not less than 8 total hours of ventilation per 24 hour period.
- 5) Where a crawl space is divided into 2 or more compartments, each heated compartment shall conform to Sentence (1) or (2).

**9.32.3.8. Air Ducts**

- 1) Except as required by Sentence (3), this Article applies to air ducts other than those described in Article 9.32.1.3.
- 2) *Exhaust ducts* shall discharge to the outdoors.
- 3) *Exhaust ducts* that are downstream of an exhaust fan shall have no connections to other fans or ducts.
- 4) *Exhaust ducts*, and *supply ducts* that conduct heated or cooled air, shall
  - a) be sized in accordance with the requirements of the manufacturer of the fans to which they are connected, and
  - b) have an equivalent diameter not less than that specified by Table 9.32.3.8.(3).

**Table 9.32.3.8.(3)**  
**Maximum Equivalent Duct Length(1), m**  
**Forming part of Sentence 9.32.3.8.(3)**

Flexible Duct						
Equivalent Diameter, mm (Cross Section Area for Rectangular Ducts, cm <sup>2</sup> )	Fan Capacity, L/s					
	25	40	50	60	70	80
125 (123)	32	15	—	—	—	—
150 (177)	46	40	28	18	13	—
175 (240)	46	46	46	46	46	24
200 (314)	46	46	46	46	46	46
Rigid Duct						
Equivalent Diameter, mm (Cross Section Area for Rectangular Ducts, cm <sup>2</sup> )	Fan Capacity, L/s					
	25	40	50	60	70	80
100 (79)	32	15	—	—	—	—
125 (123)	46	40	28	18	13	—
150 (177)	46	46	46	42	34	24
175 (240)	46	46	46	46	46	46

**Notes to Table 9.32.3.8.(3):**

<sup>(1)</sup> The equivalent length of a duct is the length of the duct plus 10 m for the exterior hood and 3 m for each 90° elbow.

- 5) Where an *exhaust duct* passes through or is located adjacent to a space that is not *conditioned space*, the duct shall conform to ~~Article 9.36.3.2~~ Part 10, except that in no case shall such a duct be insulated to less than RSI 0.75.

- 6) Where a principal ventilation system *supply duct* passes through or is located adjacent to a *conditioned space*, the duct shall be
  - a) insulated to not less than RSI 0.75, and
  - b) provided with an effective vapour barrier.
- 7) Where a kitchen exhaust fan grille is installed within 1.2 m horizontally of a *cooktop*, the exhaust fan duct shall
  - a) be constructed of a material that is noncombustible, corrosion-resistant, and cleanable, and
  - b) be equipped with a grease filter at the intake end.
- 8) Except for a supply air system described in Sentence 9.32.3.4.(2) or (3), all joints in *exhaust ducts*, and in *supply ducts* that conduct conditioned air, shall be sealed against air leakage with
  - a) sealants or gaskets made from liquids, mastics or heat-applied materials,
  - b) mastic with embedded fabric,
  - c) foil-faced butyl tape, or
  - d) aluminum foil tape.
- 9) *Supply ducts* for a mechanical ventilation system shall not be used to provide combustion or dilution air to fuel-burning *appliances*.

#### **9.32.3.9. Outdoor Inlets and Outlets**

- 1) Outdoor air inlets and exhaust outlets shall be shielded from the weather, birds and rodents by using hoods incorporating a screen of corrosion-resistant material with openings of 6 to 12 mm.

#### **9.32.3.10. Interior Distribution**

- 1) Interior doors shall be undercut by a minimum of 12 mm above the finished floor or the rooms shall be provided with an air-transfer grille with an unobstructed vent area that is not less than 100 cm<sup>2</sup>.

### **9.32.4. Additional Protection Against Depressurization**

#### **9.32.4.1. Protection Requirements**

- 1) Additional make-up air for the actual *appliance* exhaust rate shall be provided for any *appliance* that discharges air to the exterior at an installed rate exceeding 0.5 air changes per hour when it is located within a *dwelling unit* or house with a *secondary suite* that contains a vented *appliance* that is subject to back drafting (Naturally Aspirating Fuel Fired Vented Appliance). (See Note A-9.32.4.1.)
- 2) Where additional make-up air is required for *appliances* described in Sentence (1), it shall be provided by a supply fan rated to deliver outdoor air at the rate of the installed exhaust *appliance*.
- 3) The supply fan as required in Sentence (2) shall be interconnected with the exhaust fan for which make-up air is required.
- 4) The outdoor air required by Sentence (3) shall be
  - a) tempered to at least 1°C before being introduced to a normally unoccupied area of the *dwelling unit* or house with a *secondary suite* including their common spaces, or

b) tempered to at least 12°C before being introduced to occupied areas either by passive transfer grille or directly from outside.

#### **9.32.4.2. Carbon Monoxide Alarms**

(See Note A-9.32.4.2.)

1) This Article applies to every *building* that contains a *residential occupancy, a business and personal services occupancy, or a mercantile occupancy* and that

- a) is served by or contains a fuel-burning *appliance*, or
- b) contains a *storage garage*.

2) Carbon monoxide (CO) alarms installed in a *residential occupancy* required by this Article shall

- a) conform to CSA 6.19, "Residential carbon monoxide alarming devices,"
- b) be equipped with an integral alarm that satisfies the audibility requirements of CSA 6.19, "Residential carbon monoxide alarming devices,"
- c) have no disconnect switch between the overcurrent device and the CO alarm, where the CO alarm is powered by the *dwelling unit's* electrical system, and
- d) be installed as recommended by the manufacturer.

3) Where a room in a *residential occupancy* contains a solid-fuel-burning *appliance*, a CO alarm conforming to CSA 6.19, "Residential carbon monoxide alarming devices," shall be

- a) installed as recommended by the manufacturer where these instructions specifically mention solid-fuel-burning *appliances*, or
- b) in the absence of specific instructions related to solid-fuel-burning *appliances*, on or near the ceiling.

4) Where a fuel-burning *appliance* is installed in a *suite of residential occupancy*, a CO alarm shall be installed

- a) inside each bedroom, or
- b) outside each bedroom, within 5 m of each bedroom door, measured following corridors and doorways.

5) Where a fuel-burning *appliance* serves a *residential occupancy* and is installed in a *service room* that is not in a *suite of residential occupancy*, a CO alarm shall be installed

- a) either inside each bedroom, or if outside, within 5 m of each bedroom door, measured following corridors and doorways, in every *suite of residential occupancy* that shares a wall or floor/ceiling assembly with the *service room*, and
- b) in the *service room*.

6) For each *suite of residential occupancy* that shares a wall or floor/ceiling assembly with a *storage garage* or that is adjacent to an attic or crawl space to which the *storage garage* is also adjacent, a CO alarm shall be installed

- a) inside each bedroom, or
- b) outside each bedroom, within 5 m of each bedroom door, measured following corridors and doorways.

7) Where CO alarms are installed in a house with a *secondary suite* including their common spaces, the CO alarms shall be interconnected so that the actuation of any one CO alarm causes all CO alarms within the house with a *secondary suite* including their common spaces to sound.

8) CO alarms installed in a *business and personal services occupancy*, or a *mercantile occupancy* as required by this Article shall conform to

a) CAN/CSA-6.19, "Residential carbon monoxide alarming devices," notwithstanding the scope of that standard,

b) UL 2034, "Standard for Single and Multiple Station Carbon Monoxide Alarms," notwithstanding the scope of that standard, or

c) good engineering practice.

(See Note A-6.9.3.1.(6).)

9) Where a fuel-burning *appliance* serves a *business and personal services occupancy*, or *mercantile occupancy*, a CO alarm shall be,

a) where the fuel-burning *appliance* is part of a system that could circulate or distribute CO to a *suite of business and personal services occupancy* or *mercantile occupancy*, installed on each *storey* of each *suite* that may be exposed, and

b) installed in the room or space in which the fuel-burning *appliance* is located.

(See Note A-6.9.3.1.(7).)

10) For each *suite of business and personal services occupancy* or *mercantile occupancy* that shares a wall or floor/ceiling assembly with either a *storage garage*, or a *service room* containing a fuel-burning *appliance*, or that is adjacent to an attic or crawl space to which either a *storage garage*, or a *service room* containing a fuel-burning *appliance* is also adjacent, a CO alarm shall be installed

a) on each *storey* of the adjacent *suite*, and

b) in each *service room* containing a fuel-burning *appliance*.

(See Note A-6.9.3.1.(8).)

## **Section 9.33. Heating and Air-conditioning**

### **9.33.1. General**

#### **9.33.1.1. Application**

1) This Section applies to the design and installation of

a) heating systems, including requirements for combustion air, and air-conditioning systems serving only one *dwelling unit* or houses with a *secondary suite* including their common spaces, and

b) reserved.

2) The design and installation of heating systems, including requirements for combustion air, and air-conditioning systems other than those described in Sentence (1) shall conform to Part 6. (See Note A-9.33.1.1.(2) and Subsection 9.10.10.)

3) Unless the air duct distribution systems serving one of the *dwelling units* in a single detached house are designed and installed to prevent the circulation of smoke in accordance with Sentence 9.32.3.2.(4) and equipped with *fire dampers* in accordance with Sentence 9.32.3.2.(5), the

air duct distribution system shall not be directly interconnected with another principal dwelling unit and common spaces.

4) Systems used for heating and air-conditioning shall conform to the energy efficiency requirements in Section 9.36.

## **9.33.2. Required Heating and Cooling Systems**

### **9.33.2.1. Required Heating and Cooling Systems**

1) Residential *buildings* intended for use in the winter months on a continuing basis shall be equipped with heating facilities conforming to this Section.

2) Except where determination according to Article 9.33.5.1. or good engineering practice according to Article 6.2.1.1. can show it to be unnecessary, *dwelling units* intended for use in the summer months on a continuing basis shall be equipped with cooling facilities conforming to this Section. (See Note A-9.33.2.1.(2).)

## **9.33.3. Design Temperatures**

### **9.33.3.1. Indoor Design Temperatures**

1) At the outside winter design temperature, required heating facilities shall be capable of maintaining an indoor air temperature of not less than

- a) 22°C in all living spaces,
- b) 18°C in unfinished *basements*,
- c) 18°C in common *service rooms*, ancillary spaces and *exits* in single detached houses, and
- d) 15°C in heated crawl spaces.

2) At the outside summer design temperature, required cooling facilities shall be capable of maintaining an indoor air temperature of not more than 26°C in at least one living space in each *dwelling unit*.

### **9.33.3.2. Outdoor Design Temperatures**

1) The outdoor conditions to be used in designing heating and air-conditioning systems shall be determined in conformance with Article 1.1.3.1.

## **9.33.4. General Requirements for Heating and Air-conditioning Systems**

### **9.33.4.1. Design of Heating and Air-conditioning Systems**

1) Aspects of heating and air-conditioning systems not specifically addressed in this Subsection, including ducting, and mechanical heating and refrigeration equipment, shall be designed, constructed and installed in accordance with good practice such as that described in the ASHRAE Handbooks and Standards, the HRAI Digest, the CHC Handbook on Hydronic Heating Systems, the Hydronics Institute Manuals, the SMACNA Manuals and the TECA Quality First Manuals. (See also Subsection 9.32.3. for the design of systems that also provide ventilation.)

### **9.33.4.2. Installation of Hydronic Heating Systems**

1) The installation of a hydronic heating system shall conform to CSA B214, "Installation code for hydronic heating systems."

### **9.33.4.3. Heating System Control**

1) Where a single heating system serves a house with a *secondary suite*, individual temperature controls shall be provided in each *dwelling unit* served by the system. (See Note A-9.33.4.3.(1).)

#### **9.33.4.4. Access**

(See Note A-9.33.4.4.)

1) Equipment forming part of a heating or air-conditioning system, with the exception of embedded pipes or ducts, shall be installed with provision for access for inspection, maintenance, repair and cleaning.

2) Where a heating or air-conditioning system serves more than one *dwelling unit* in a house with a *secondary suite* including their common spaces, access required by Sentence (1) from more than one *dwelling unit*, common space or ancillary space is not required.

#### **9.33.4.5. Protection from Freezing**

1) Equipment forming part of a heating or air-conditioning system that may be adversely affected by freezing temperatures and that is located in an unheated area shall be protected from freezing.

#### **9.33.4.6. Expansion, Contraction and System Pressure**

1) Heating and cooling systems shall be designed to allow for expansion and contraction of the heat transfer fluid and to maintain the system pressure within the rated working pressure limits of all components of the system.

#### **9.33.4.7. Structural Movement**

1) Mechanical systems and equipment shall be designed and installed to accommodate the maximum amount of structural movement provided for in the construction of the *building*.

2) Where the *building* is in a location where the seismic design parameter,  $S_{max}$ , for Site Class C is greater than 0.37, heating and air-conditioning equipment with fuel or power connections shall be secured to the structure to resist overturning and displacement. (See Note A-9.31.6.2.(3).)

#### **9.33.4.8. Asbestos**

1) Asbestos shall not be used in air distribution systems or equipment.

#### **9.33.4.9. Contaminant Transfer**

1) Systems serving garages, and systems serving other occupied parts of a *dwelling unit* but located in or running through a garage, shall be designed and constructed in a manner such that means are not provided for the transfer of contaminants from the garage into other spaces in the *dwelling unit*.

#### **9.33.4.10. Noise Control**

1) Heating and air-conditioning equipment shall be installed and located so that the noise generated by this equipment conforms with the Vancouver Noise Control By-law.

### **9.33.5. Heating and Cooling Appliances and Equipment**

#### **9.33.5.1. Capacity of Heating and Cooling Appliances**

1) The required capacity of heating and cooling *appliances* located in a *dwelling unit* and serving only that *dwelling unit*, shall be determined in accordance with CSA F280, "Determining the required capacity of residential space heating and cooling appliances," except that the design temperatures shall conform to Subsection 9.33.3.

#### **9.33.5.2. Installation Standards**



1) Except as provided in Articles 9.33.5.3. and 9.33.5.4., the installation of heating and air-conditioning equipment, including mechanical refrigeration equipment, and including provisions for mounting, clearances and air supply, shall conform to

- a) the Safety Standards Act and pursuant regulations,
- b) CSA B139 Series, "Installation code for oil-burning equipment," and
- c) CAN/CSA-C448 Series, "Design and installation of earth energy systems."

(See also Sentence 9.33.5.3.(1).)

### **9.33.5.3. Design, Construction and Installation Standard for Solid-Fuel-Burning Appliances**

(See Note A-9.33.5.3.)

1) The design, construction and installation, including the provision of combustion air, of solid-fuel-burning *appliances* and equipment, including *stoves, cooktops, ovens and space heaters*, shall conform to CSA B365, "Installation Code for Solid-Fuel-Burning Appliances and Equipment."

2) For the purposes of Sentence (1), solid-fuel-burning boiler *appliances* that are approved for use under section 10 of the Safety Standards Act satisfy section 4.1 of CAN/CSA-B365 "Installation Code for Solid-Fuel-Burning Appliances and Equipment." (See also Subclause 9.33.5.2.(1)(a)(ii).)

### **9.33.5.4. Fireplaces**

1) Fireplaces shall conform to Section 9.22.

### **9.33.6. Air Duct Systems**

#### **9.33.6.1. Application**

1) The design, construction and installation of air duct distribution systems serving heating systems in which the rated heat input does not exceed 120 kW shall conform to this Subsection.

2) Air duct distribution systems in which the rated heat input exceeds 120 kW shall conform to Part 6 and Subsection 3.6.5.

#### **9.33.6.2. Materials in Air Duct Systems**

1) Except as provided in Sentences (2) to (6) and in Article 3.6.4.3., all ducts, duct connectors, associated fittings and *plenums* used in air duct systems shall be constructed of steel, aluminum alloy, copper, clay or similar *noncombustible* material.

2) Ducts, associated fittings and *plenums* are permitted to contain *combustible* material provided they

a) conform to the appropriate requirements for Class 1 duct materials in CAN/ULC-S110, "Standard Methods of Test for Air Ducts,"

b) conform to Article 3.1.5.18. and Subsection 3.1.9.,

c) are not used in vertical runs serving more than 2 *storeys*, and

d) are not used in air duct systems in which the air temperature may exceed 120°C.

3) Duct sealants shall have a *flame-spread rating* of not more than 25 and a smoke developed classification of not more than 50.

4) Duct connectors that contain *combustible* materials and that are used between ducts and air outlet units shall

a) conform to the appropriate requirements for Class 1 air duct materials in CAN/ULC-S110, "Standard Methods of Test for Air Ducts,"

b) be limited to 4 m in length,

c) be used only in horizontal runs, and

d) not penetrate required *fire separations*.

5) *Combustible* ducts that are part of a duct system carrying only ventilation air and that are contained entirely within a *dwelling unit* need not comply with the requirements of Sentences (1) to (4).

6) Except as provided in Sentences 9.33.6.13.(2) and (3), ducts that are part of a return-air duct system and that are contained entirely within a *dwelling unit* need not comply with the requirements of Sentences (1) to (4).

7) Materials referred to in Sentences (1) to (6), when used in a location where they may be subjected to excessive moisture, shall

a) have no appreciable loss of strength when wet, and

b) be corrosion-resistant.

#### **9.33.6.3. Tape**

1) Tape used for sealing duct joints in air ducts, *plenums* and other parts of air duct systems shall meet the flame-resistance requirements for fabric in CAN/ULC-S109, "Standard Method for Flame Tests of Flame-Resistant Fabrics and Films."

#### **9.33.6.4. Coverings, Linings, Adhesives and Insulation**

1) Coverings, linings and associated adhesives and insulation of air ducts, *plenums* and other parts of air duct systems shall be of *noncombustible* material when exposed to heated air or radiation from heat sources that would result in the exposed surface exceeding a temperature of 120°C.

2) Except as provided in Sentence (3), when *combustible* coverings and linings, including associated adhesives and insulation, are used, they shall have

a) a *flame-spread rating* of not more than 25 on any exposed surface, or any surface that would be exposed by cutting through the material in any direction, and

b) a smoke developed classification of not more than 50.

3) The outer covering of ducts, *plenums* and other parts of air duct systems used within an assembly of *combustible construction* are permitted to have

a) an exposed surface *flame-spread rating* of not more than 75, and

b) a smoke developed classification greater than 50.

4) *Combustible* coverings, linings and foamed plastic insulation described in Sentences (2), (3) and (6) shall not flame, glow, smoulder or smoke when tested in accordance with the method of test in ASTM C411, "Standard Specification for Hot-Surface Performance of High-Temperature Thermal Insulation," at the maximum temperature to which they are to be exposed in service.

5) Except as provided in Sentences (6) and (7), foamed plastic insulation shall not be used as part of an air duct.

- 6) Foamed plastic insulation conforming to Article 9.25.2.2. is permitted to be used to insulate a galvanized steel, stainless steel or aluminum air duct, provided
- a) the foamed plastic insulation applied to supply ductwork is not less than 3 m from the *furnace* bonnet,
  - b) the temperature within the ductwork where the insulation is installed is not greater than 50°C,
  - c) duct joints are taped with a product conforming to Sentence 9.33.6.3.(1),
  - d) return air *plenums* are separated from the foamed plastic insulation, and
  - e) the foamed plastic insulation is protected
    - i) by one of the interior finishes described in Subsections 9.29.4. to 9.29.9.,
    - ii) provided the *building* does not contain a Group C *major occupancy*, by sheet metal that is mechanically fastened to the supporting assembly independent of the insulation, is not less than 0.38 mm thick and has a melting point of 650°C or more, or
    - iii) by any thermal barrier that meets the requirements of Clause 3.1.5.15.(2)(e).
- 7) Foamed plastic insulation is permitted to be used in a ceiling space that acts as a return air *plenum* provided the foamed plastic insulation is protected from exposure to the *plenum* in accordance with Sentence 3.1.5.14.(4).
- 8) *Combustible* coverings and linings of ducts, including associated adhesives and insulation, shall be interrupted
- a) at the immediate area of operation of heat sources in a duct system, such as electric resistance heaters or fuel-burning heaters or *furnaces*, and
  - b) where the duct penetrates a *fire separation*.
- 9) Linings of ducts shall be installed so that they will not interfere with the operation of volume or balancing dampers or of *fire dampers*, *fire stop flaps* and other closures.

**9.33.6.5. Galvanized Steel or Aluminum Supply Ducts**

- 1) Galvanized steel or aluminum *supply ducts* shall conform to Table 9.33.6.5.
- 2) The design of fittings for ducts shall conform to ANSI/SMACNA 006, "HVAC Duct Construction Standards – Metal and Flexible," except that metal thicknesses shall conform to Table 9.33.6.5.

**Table 9.33.6.5.  
Minimum Metal Thickness of Ducts  
Forming Part of Article 9.33.6.5.**

Type of Duct	Maximum Diameter, mm	Maximum Width or Depth, mm	Minimum metal thickness, mm	
			Duct Material	
			Galvanized Steel	Aluminum
Round ducts serving single <i>dwelling units</i>	125 or less	—	0.254	0.30
Round	350	—	0.33	0.30
	Over 350	—	0.41	0.41

Rectangular, enclosed	—	350	0.33	0.30
	—	Over 350	0.41	0.41
Rectangular, not enclosed, for single <i>dwelling units</i> , with required clearance up to 12 mm	—	350	0.33	0.41
	—	Over 350	0.41	0.48
Rectangular, not enclosed, with required clearance of more than 12 mm	—	350	0.41	0.41
	—	Over 350	0.48	0.48

#### **9.33.6.6. Construction of Ducts and Plenums**

1) Where the installation of heating *supply ducts* in walls and floors creates a space between the duct and construction material, the space shall be firestopped with *noncombustible* material at each end.

2) Ducts shall be securely supported by metal hangers, straps, lugs or brackets, except that, where zero clearance is permitted, wooden brackets are permitted to be used.

3) All round duct joints shall be tight-fitting and lapped not less than 25 mm.

4) Rectangular duct connections shall be made with S and drive cleats or equivalent mechanical connections.

5) Duct systems shall have no openings other than those required for the proper operation and maintenance of the system.

#### **9.33.6.7. Installation of Ducts and Plenums**

1) Air duct systems serving garages shall not be interconnected with other parts of the *dwelling unit*.

2) Trunk *supply ducts* shall not be nailed directly to wood members.

3) Branch ducts shall be supported at suitable spacings to maintain alignment and prevent sagging.

4) Ducts passing through unheated spaces shall have all joints taped or otherwise sealed to ensure that the ducts are airtight throughout their length.

5) *Combustible* ducts in concrete slabs-on-ground that are connected to a *furnace supply plenum* shall be located not closer than 600 mm to that *plenum* and not less than 600 mm from its connection to a riser or register.

6) Ducts in or beneath concrete slabs-on-ground shall be watertight and corrosion-, decay-, and mildew-resistant.

7) Underground ducts shall

a) be constructed to provide interior drainage from and access to all low points, and

b) not be connected directly to a sewer.

#### **9.33.6.8. Clearances of Ducts and Plenums**

1) The clearance of *furnace plenums* from *combustible* material shall conform to the appropriate standards in Sentence 9.33.5.2.(1).

2) Where the *plenum* clearance required in Sentence (1) is 75 mm or less, the clearance between a *supply duct* and *combustible* material shall

a) be equal to the required *plenum* clearance within 450 mm of the *plenum*, and

b) be not less than 12 mm at a distance of 450 mm or more from the *plenum*, except that this clearance may be reduced to zero beyond a bend or offset in the duct sufficiently large to shield the remainder of the *supply duct* from direct radiation from the *furnace* heat exchanger. (See Note A-3.6.5.6.(2).)

3) Where the *plenum* clearance required in Sentence (1) is more than 75 mm but not more than 150 mm, the clearance between a *supply duct* and *combustible* material shall be

a) equal to the required *plenum* clearance within a horizontal distance of 1.8 m of the *plenum*, and

b) not less than 12 mm at a horizontal distance of 1.8 m or more from the *plenum*, except that this distance may be reduced to zero beyond a bend or offset in the duct sufficiently large to shield the remainder of the duct from direct radiation from the *furnace* heat exchanger. (See Note A-3.6.5.6.(3).)

4) Where the *plenum* clearance required in Sentence (1) is more than 150 mm, the clearance between a *supply duct* and *combustible* material shall be

a) equal to the required *plenum* clearance within a horizontal distance of 1 m of the *plenum*,

b) not less than 150 mm within a horizontal distance between 1 m and 1.8 m from the *plenum*, and

c) not less than 25 mm at a horizontal distance of 1.8 m or more from the *plenum*, except that this distance may be reduced to 8 mm beyond a bend or offset in the duct sufficiently large to shield the remainder of the *supply duct* from direct radiation from the *furnace* heat exchanger. (See Note A-3.6.5.6.(4).)

5) Where a register is installed in a floor directly over a pipeless *furnace*, a double-walled register box with not less than 100 mm between walls, or a register box with the warm-air passage completely surrounded by the cold-air passage, shall be permitted in lieu of the clearances listed in Sentences (2) to (4).

#### **9.33.6.9. Adjustable Dampers and Balance Stops**

1) All branch *supply ducts* that are not fitted with diffusers with adjustable balance stops shall be supplied with adjustable dampers and fitted with devices to indicate the positions of the dampers.

#### **9.33.6.10. Warm-Air Supply Outlets and Return Inlets — General**

1) Supply outlets and return openings in the *dwelling unit*, when located less than 2 m above the floor, shall be protected by grilles having openings of a size that will not allow the passage of a 15 mm diam sphere.

2) *Combustible* grilles, diffusers and other devices for the supply and return air openings installed in walls and ceilings shall have a *flame-spread rating* of

a) not more than 200 in bathrooms, and

b) not more than 150 in rooms or spaces other than bathrooms.

#### **9.33.6.11. Warm-Air Supply Outlets**

1) In a *dwelling unit*, a warm-air supply outlet shall be provided in each finished room that is located adjacent to unheated space.

2) Except as provided in Sentence (3), when a room described in Sentence (1) is located adjacent to exterior walls, such outlet shall be located so as to bathe at least one exterior wall or

window with warm air, except in bathrooms, utility rooms or kitchens, where this may not be practical.

3) Where the heating system is also designed to provide ventilation air, ceiling outlets or outlets located high on interior walls are permitted to be installed, provided the outlets are designed for this purpose and are installed with diffusers.

4) At least one warm-air supply outlet shall be provided for each 40 m<sup>2</sup> of floor surface area in unfinished *basements* serving *dwelling units*, and it shall be located so as to provide adequate distribution of warm air throughout the *basement*.

5) At least one warm-air supply outlet shall be provided for each 80 m<sup>2</sup> of floor surface area in heated crawl spaces serving *dwelling units*, and it shall be located so as to provide adequate distribution of warm air throughout the crawl space.

6) Except for pipeless *furnaces*, the capacity of warm-air supply outlets serving *dwelling units* shall be not less than the design heat loss from the area served and shall not exceed 3 kW per outlet.

7) In *basements* and heated crawl spaces, the calculated heat gain from the *supply ducts* and *plenum* surfaces is permitted to be considered in calculating the design heat loss.

8) The temperature of supply air at warm-air supply outlets shall not exceed 70°C.

9) Warm-air supply outlets located in finished areas shall be provided with diffusers and adjustable openings and shall not be located on a *furnace plenum*.

#### **9.33.6.12. Return-Air Inlets**

1) Return-air inlets shall not be installed in an enclosed room or crawl space that provides combustion air to a *furnace*.

2) Except for unfinished areas and floor levels which are less than 900 mm above or below an adjacent floor level which is provided with a return-air inlet, at least one return-air inlet shall be provided in each floor level in a *dwelling unit*.

3) Provision shall be made for the return of air from all rooms by leaving gaps beneath doors, using louvred doors or installing *return duct* inlets.

#### **9.33.6.13. Return-Air System**

(See Note A-9.33.6.13.)

1) The return-air system shall be designed to handle the entire air supply.

2) Where any part of a *return duct* will be exposed to radiation from the *furnace* heat exchanger or other radiating part within the *furnace*, such part of a *return duct* directly above or within 600 mm of the outside *furnace* casing shall be *noncombustible*.

3) *Return ducts* serving solid-fuel-burning *furnaces* shall be constructed of *noncombustible* material.

4) *Combustible return ducts* shall be lined with *noncombustible* material

a) below floor registers,

b) at the bottom of vertical ducts, and

c) under *furnaces* having a bottom return.

5) Spaces between studs or joists used as *return ducts* shall be separated from the unused portions of such spaces by tight-fitting metal stops or wood blocking.

- 6) A vertical *return duct* shall have openings to return air on not more than one floor.
- 7) The return-air system shall be designed so that the negative pressure from the circulating fan cannot
  - a) affect the *furnace* combustion air supply, nor
  - b) draw combustion products from joints or openings in the *furnace* or *flue pipe*.

#### **9.33.6.14. Filters and Odour Removal Equipment**

- 1) Air filters for air duct systems shall conform to the requirements for Class 2 air filter units as described in CAN/ULC-S111, "Standard Method of Fire Tests for Air Filter Units."
- 2) When electrostatic-type filters are used, they shall be installed so as to ensure that the electric circuit is automatically de-energized when filter access doors are opened or, in *dwelling units*, when the *furnace* circulation fan is not operating.
- 3) When odour removal equipment of the adsorption type is used it shall be
  - a) installed to provide access so that adsorption material can be reactivated or renewed, and
  - b) protected from dust accumulation by air filters installed on the inlet side.

#### **9.33.7. Radiators and Convectors**

##### **9.33.7.1. Recessed Radiators and Convectors**

- 1) Every steam or hot water radiator and convector located in a recess or concealed space or attached to the face of a wall of *combustible construction* shall be provided with a *noncombustible* lining or backing.

##### **9.33.7.2. Surface Temperature**

- 1) The exposed surface temperature of a steam or hot water radiator shall not exceed 70°C unless precautions are taken to prevent human contact.

#### **9.33.8. Piping for Heating and Cooling Systems**

##### **9.33.8.1. Piping Materials and Installation**

- 1) Piping shall be made from materials designed to withstand the effects of temperatures and pressures that may occur in the system. (See Articles 3.1.5.19., 3.1.9.1. and 9.10.9.7., and Sentence 9.10.9.9.(3) for fire safety requirements.)
- 2) Every pipe used in a heating or air-conditioning system shall be installed to allow for expansion and contraction due to temperature changes.
- 3) Supports and anchors for piping in a heating or air-conditioning system shall be designed and installed to ensure that undue stress is not placed on the supporting structure.

##### **9.33.8.2. Insulation and Coverings**

- 1) Insulation and coverings on pipes shall be composed of material suitable for the operating temperature of the system to withstand deterioration from softening, melting, mildew and mould.
- 2) Insulation and coverings on pipes in which the temperature of the fluid exceeds 120°C
  - a) shall be made of *noncombustible* material, or
  - b) shall not flame, glow, smoulder or smoke when tested in accordance with ASTM C411, "Standard Specification for Hot-Surface Performance of High-Temperature Thermal Insulation," at the maximum temperature to which such insulation or covering is to be exposed in service.

3) Except as provided in Sentence (6), where *combustible* insulation is used on piping in a horizontal or *vertical service space*, the insulation and coverings on such pipes shall have a *flame-spread rating* throughout the material of not more than

- a) 25 in *buildings of noncombustible construction*, and
- b) 75 in *buildings of combustible construction*.

4) Except as provided in Sentence (6), insulation and coverings on piping located in rooms and spaces other than the *service spaces* described in Sentence (3) shall have a *flame-spread rating* not more than that required for the interior finish for the ceiling of the room or space.

5) Pipes that are exposed to human contact shall be insulated so that the exposed surface does not exceed 70°C. (See Note A-6.5.1.1.(3).)

6) No *flame-spread rating* or smoke developed classification limitations are required where *combustible* insulation and coverings are used on piping when such piping is

- a) located within a concealed space in a wall,
- b) located in a floor slab, or
- c) enclosed in a *noncombustible* raceway or conduit.

**9.33.8.3. Clearances**

1) Clearances between *combustible* material and bare pipes carrying steam or hot water shall conform to Table 9.33.8.3.

**Table 9.33.8.3.**

**Clearance between Steam or Hot Water Pipes and Combustible Material**

**Forming Part of Sentence 9.33.8.3.(1)**

Steam or Water Temperature (T), °C	Minimum Clearance, mm
T ≤ 95	no clearance required
95 < T ≤ 120	15
T > 120	25

**9.33.8.4. Protection**

1) Where a pipe carrying steam or hot water at a temperature above 120°C passes through a *combustible* floor, ceiling or wall, the construction shall be protected by a sleeve of metal or other *noncombustible* material not less than 50 mm larger in diameter than the pipe.

2) Unprotected steam or hot water pipes that pass through a storage space shall be covered with not less than 25 mm thickness of *noncombustible* insulation to prevent direct contact with the material stored.

**9.33.9. Refrigerating Systems and Equipment for Air-conditioning**

**9.33.9.1. Cooling Units**

1) Where a cooling unit is combined with a fuel-fired *furnace* in the same duct system, the cooling unit shall be installed

- a) in parallel with the heating *furnace*,
- b) upstream of the *furnace*, provided the *furnace* is designed for such application, or



c) downstream of the *furnace*, provided the cooling unit is designed to prevent excessive temperature or pressure in the refrigeration system.

## **9.33.10. Chimneys and Venting Equipment**

### **9.33.10.1. Requirement for Venting**

1) Except as provided in Articles 9.33.10.2. and 9.33.10.3., the products of combustion from oil-, gas- and solid-fuel-burning *appliances*, including *stoves, cooktops, ovens and space heaters*, shall be vented in conformance with the applicable *appliance* installation standard listed in Sentences 9.33.5.2.(1) and 9.33.5.3.(1).

### **9.33.10.2. Factory-Built Chimneys**

1) *Factory-built chimneys* serving solid-fuel-burning *appliances*, and their installation, shall conform to CAN/ULC-S629, "Standard for 650°C Factory-Built Chimneys." (See Note A-9.33.10.2.(1).)

### **9.33.10.3. Masonry or Concrete Chimneys**

1) *Masonry or concrete chimneys* shall conform to Section 9.21.

### **9.33.10.4. Location of Exhaust Vents Serving Single Detached Houses and Duplexes**

1) Exhaust Vents from heating and air conditioning equipment and similar appliances, other than direct vented fireplaces in a single detached house or duplex, shall be directed

a) vertically through the roof of a *building*, with the discharge located at least 1.5 m away from any property line, or

b) horizontally through an exterior wall which faces a *street* or a *lane*, with the discharge located at least 3 m away from any property line.

## **Section 9.34. Electrical Facilities**

### **9.34.1. General**

#### **9.34.1.1. Standard for Electrical Installations**

1) Electrical installations, including the service capacity of the installation and the number and distribution of circuits and receptacles, shall meet the requirements of the appropriate provincial, territorial or municipal legislation or, in the absence of such legislation, shall conform to the Safety Standards Act and pursuant regulations.

2) In addition to the requirements of Sentence (1), electrical installations in a principal dwelling unit containing an ancillary residential unit in a residential suite in an apartment building required to conform to Section 9.37 shall also comply with the following:

a) the electrical service size shall be based on the demand load calculated on the total area of the principal dwelling unit including any associated ancillary residential unit, provided that

i) for each electrical range additional to the first range, 6 kW demand shall be added for a rating of 12 kW or less, plus 40% of the amount by which the rating of the range exceeds 12 kW, and

ii) except for the first electrical range referred to in Subclause (2)(a)(i), any electrical equipment loads provided for shall be calculated in conformance with Sentence (1), and

b) a single panel board may supply electrical loads of the dwelling units referred to in Clause (2)(a) except for the residential suite containing an ancillary residential unit in an apartment

building, provided that it is located within the building in a common area accessible to all occupants of the building.

3) Circuit breakers of panel boards installed in the dwelling units

a) shall be positioned not less than 600 mm above the finished floor level, and

b) notwithstanding the requirements of Sentence (1) and 3.8.5.7.(2), shall be positioned as high as feasible with the branch circuit breakers not more than 1500 mm above the finished floor level.

#### **9.34.1.2. Required Facilities**

1) Where electrical services are available, electrical facilities shall be provided for every *building* in conformance with this Section.

#### **9.34.1.3. Location of Equipment in Public Areas**

1) Entrance switches, meters, panel boxes, splitter boxes, time clocks and other similar equipment shall not be located in any public area unless adequate precautions are taken to prevent interference with the equipment.

#### **9.34.1.4. Recessed Lighting Fixtures**

1) Recessed lighting fixtures shall not be located in insulated ceilings unless the fixtures are designed for such installations.

#### **9.34.1.5. Wiring and Cables**

1) Except as required in Sentence (2), optical fibre cables and electrical wires and cables installed in *buildings* permitted to be of *combustible construction* shall

a) not convey flame or continue to burn for more than 1 min when tested in conformance with the Vertical Flame Test (FT1 rating) in CSA C22.2 No. 0.3, "Test Methods for Electrical Wires and Cables," or

b) be located in

i) totally enclosed *noncombustible* raceways (see Note A-3.1.4.3.(1)(b)(i)),

ii) masonry walls,

iii) concrete slabs, or

iv) totally enclosed non-metallic raceways conforming to Clause 3.1.5.23.(1)(b).

2) Except as permitted in Sentence (3), where a concealed space in a floor or ceiling assembly is used as a *plenum*, electrical wires and cables with *combustible* insulation, jackets or sheathes that are used for the transmission of voice, sound or data and optical fibre cables installed within the *plenum* shall conform to Clause 3.6.4.3.(1)(a).

3) Wires or cables within *plenum* spaces that are used for the transmission of signals in fire alarm, security, radio, and television broadcasting, closed circuit television or community television systems need not meet the requirements of Sentence (2).

### **9.34.2. Lighting Outlets**

(See Note A-9.34.2.)

#### **9.34.2.1. Lighting of Entrances**

1) An exterior lighting outlet with fixture controlled by a wall switch located within the *building* shall be provided at every entrance to *buildings* of *residential occupancy*.

#### **9.34.2.2. Outlets in Dwelling Units**

1) Except as provided in Sentence (2), a lighting outlet with fixture controlled by a wall switch shall be provided in kitchens, bedrooms, living rooms, utility rooms, laundry rooms, dining rooms, bathrooms, water-closet rooms, vestibules and hallways in *dwelling units*.

2) Where a receptacle controlled by a wall switch is provided in bedrooms or living rooms, such rooms need not conform to the requirements in Sentence (1).

#### **9.34.2.3. Stairways**

1) Every stairway shall be lighted.

2) Except as provided in Sentence (3), 3-way wall switches located at the head and foot of every stairway shall be provided to control at least one lighting outlet with fixture for stairways with 4 or more risers in *dwelling units* and houses with a *secondary suite* including their common spaces.

3) The stairway lighting for *basements* that do not contain finished space or lead to an outside entrance or built-in garage and which serve not more than one *dwelling unit* is permitted to be controlled by a single switch located at the head of the stairs.

#### **9.34.2.4. Basements**

1) A lighting outlet with fixture shall be provided for each 30 m<sup>2</sup> or fraction thereof of *floor area* in unfinished *basements*.

2) The outlet required in Sentence (1) nearest the stairs shall be controlled by a wall switch located at the head of the stairs.

#### **9.34.2.5. Storage Rooms**

1) A lighting outlet with fixture shall be provided in storage rooms.

#### **9.34.2.6. Garages and Carports**

1) A lighting outlet with fixture shall be provided for an attached, built-in or detached garage or carport.

2) Except as provided in Sentence (3), outlets required in Sentence (1) shall be controlled by a wall switch near the doorway.

3) Where the outlet and fixture required in Sentence (1) are ceiling mounted above an area not normally occupied by a parked car, or are wall mounted, a fixture with a built-in switch accessible to an adult of average height is permitted to be used.

4) Where a carport is lighted by a light at the entrance to a *dwelling unit*, additional carport lighting is not required.

#### **9.34.2.7. Public and Service Areas**

1) Every public or service area in *buildings* shall be provided with lighting outlets with fixtures controlled by a wall switch or panel to illuminate every portion of such areas.

2) When provided by incandescent lighting, illumination required in Sentence (1) shall conform to Table 9.34.2.7. (See Article 9.9.12.2. for lighting in *means of egress*.)

3) When other types of lighting are used, illumination equivalent to that shown in Table 9.34.2.7. shall be provided.

**Table 9.34.2.7.**  
**Lighting for Public Areas**

**Forming Part of Sentences 9.34.2.7.(2) and (3)**

<b>Room or Space</b>	<b>Minimum Illumination, lx</b>	<b>Minimum Lighting Power Density, W/m<sup>2</sup> of floor area (incandescent lighting)</b>
Storage rooms	50	5
<i>Service rooms</i> and laundry areas	200	20
Rooms for storage of combustible refuse	200	20
Garages	50	5
Public water-closet rooms	100	10
Service hallways and stairways	50	5
Recreation rooms	100	10

4) Notwithstanding Sentences (1) to (3), rooms and spaces used by the public shall be equipped to provide illumination as described in Sentences 3.2.7.1.(4) to (7).

**9.34.3. Emergency Lighting**

**9.34.3.1. Criteria for Emergency Lighting**

1) Emergency lighting shall conform to Subsection 9.9.12.

**Section 9.35. Garages and Carports**

**9.35.1. Scope**

**9.35.1.1. Application**

1) This Section applies to garages and carports serving not more than one *dwelling unit*.

**9.35.1.2. Construction Requirements**

1) The construction of a garage or carport shall conform to the requirements for other *buildings* in this Part except as provided in this Section.

**9.35.2. General**

**9.35.2.1. Carport Considered to be Garage**

1) Where a roofed enclosure used for the storage or parking of motor vehicles has more than 60% of the total perimeter enclosed by walls, doors or windows, the enclosure shall be considered a garage.

**9.35.2.2. Garage Floor**

1) Where an attached or built-in garage is provided and where adjacent spaces in the *building* are less than 50 mm above the garage floor,

a) the garage floor shall be sloped to the outdoors, or

b) where the garage can accommodate not more than 3 vehicles, an airtight curb or *partition* not less than 50 mm high shall be installed at the edges of the garage floor adjacent to interior space.

(See Note A-9.35.2.2.(1).)

**9.35.3. Foundations**

**9.35.3.1. Foundation Required**

1) Except as permitted in this Subsection, *foundations* conforming to Sections 9.12. and 9.15. shall be provided for the support of carport and garage super-structures, including that portion beneath garage doors.

2) Detached garages of less than 55 m<sup>2</sup> *floor area* and not more than 1 *storey* in height that are not of masonry or masonry veneer construction are permitted to be supported on

- a) wood mud sills, or
- b) a 100 mm thick concrete floor slab.

#### **9.35.3.2. Protection from Damage due to Soil Movement**

1) In clay-type *soils* subject to significant movement with a change in *soil* moisture content, the *foundation* depth of carports or garages connected to a *dwelling unit* directly or by a breezeway shall be approximately the same depth as the main *building foundation*.

2) Where slab-on-ground construction is used, a construction joint shall be provided between the main *building* slab and a slab serving an attached garage, breezeway or carport.

3) Except as provided in Section 9.12., *foundations* for attached unheated garages or carports shall be below frost level.

#### **9.35.3.3. Drainage**

1) Detached garages of less than 55 m<sup>2</sup> *floor area* and not more than 1 *storey* in height that are not of masonry or masonry veneer construction need not conform with the *foundation* drainage requirements stated in Section 9.14., where the finished ground level is at or near the elevation of the garage's floor and where the ground slopes away from the *building*.

#### **9.35.3.4. Column Piers**

1) Piers for the support of carport columns shall extend not less than 150 mm above ground level.

2) Piers referred to in Sentence (1) shall project not less than 25 mm beyond the base of the column but in no case be less than 190 mm by 190 mm in size.

### **9.35.4. Walls and Columns**

#### **9.35.4.1. Interior Finish**

1) Interior finish need not be applied to garage and carport walls.

#### **9.35.4.2. Columns**

1) Columns for garages and carports shall conform to Section 9.17., except that 89 mm by 89 mm wood columns may be used.

#### **9.35.4.3. Anchorage**

1) Garage or carport walls and columns shall be anchored to the *foundation* to resist wind uplift in conformance with Subsection 9.23.6., except that where a garage is supported on the surface of the ground, ground anchors shall be provided to resist wind uplift.

## **Section 9.36. Deleted**

## **Section 9.37. Deleted**

## Section 9.38. Objectives and Functional Statements

### 9.38.1. Objectives and Functional Statements

#### 9.38.1.1. Attributions to Acceptable Solutions

1) For the purpose of compliance with this Code as required in Clause 1.2.1.1.(1)(b) of Division A, the objectives and functional statements attributed to the acceptable solutions in this Part shall be the objectives and functional statements listed in Table 9.38.1.1. (See Note A-1.1.2.1.(1).)

Table 9.38.1.1.

#### Objectives and Functional Statements Attributed to the Acceptable Solutions in Part 9 Forming Part of Sentence 9.38.1.1.(1)

Provision	Functional Statements and Objectives <sup>(1)</sup>
<b>9.3.1.1. General</b>	
(1)	[F20-OS2.1] [F20,F21,F80-OS2.3]
	[F20-OP2.1,OP2.4] [F21-OP2.3,OP2.4] [F20,F80-OP2.3]
	[F20,F21,F80-OH1.1] Applies where concrete supports or is used in the walls of <i>chimneys</i> or fireplaces. [F20,F21,F55,F61,F80-OH1.1,OH1.2] [F20,F21,F61,F80-OH1.3] Applies where concrete supports or is used in an environmental separator.
	[F20,F21,F80-OH4] Applies where concrete elements support wood-frame floors.
	[F20,F21,F80-OS3.1,OS3.7] Applies to concrete floors or steps, concrete that supports wood-frame floors or steps, and concrete steps that support <i>guards</i> or handrails. [F20,F21,F80-OS3.4] Applies where concrete supports or is used in <i>chimneys</i> or fireplaces.
	[F20,F21,F80-OS1.1] Applies where concrete supports or is used in <i>chimneys</i> or fireplaces.
(4)	[F20-OS2.1] [F80-OS2.3] [F20-OS2.3] Applies to elements that support or are part of an environmental separator.
	[F20-OP2.1,OP2.4] [F21,F80-OP2.3,OP2.4] [F20-OP2.3] Applies to elements that support or are part of an environmental separator.
	[F20,F21,F80-OH1.1] Applies where concrete supports or is used in the walls of <i>chimneys</i> or fireplaces. [F20,F21,F80,F61,F55-OH1.1,OH1.2] [F20,F21,F80,F61-OH1.3] Applies to elements that support or are part of an environmental separator.
	[F20,F21,F80-OH4] Applies to elements that support floors.
	[F20,F80-OS3.1] Applies to concrete that supports wood-frame floors or steps. [F20,F80-OS3.4,OS3.7] Applies where concrete supports or is used in <i>chimneys</i> or fireplaces.
	[F20,F80-OS1.1] Applies where concrete supports or is used in <i>chimneys</i> or fireplaces.
<b>9.3.1.2. Cement</b>	

(1)	[F20-OS2.1] [F80-OS2.3] [F20-OS2.3] Applies to elements that support or are part of an environmental separator.
	[F20-OP2.1,OP2.4] [F80-OP2.3,OP2.4] [F20-OP2.3] Applies to elements that support or are part of an environmental separator.
	[F20,F80-OH1.1] Applies where concrete supports or is used in the walls of <i>chimneys</i> or fireplaces. [F20,F80,F61,F55-OH1.1,OH1.2] [F20,F80,F61-OH1.3] Applies where concrete supports or is used in an environmental separator.
	[F20,F80-OH4] Applies where concrete elements support wood-frame floors.
	[F20,F80-OS3.1] Applies to concrete floors or steps, concrete that supports wood-frame floors or steps, and concrete steps that support <i>guards</i> or handrails. [F20,F80-OS3.4,OS3.7] Applies where concrete supports or is used in <i>chimneys</i> or fireplaces.
	[F20,F80-OS1.1] Applies where concrete supports or is used in <i>chimneys</i> or fireplaces.
<b>9.3.1.3. Concrete in Contact with Sulphate Soil</b>	
(1)	[F20-OS2.1] [F80-OS2.3] [F20-OS2.3] Applies to elements that support or are part of an environmental separator.
	[F20-OP2.1,OP2.4] [F80-OP2.3,OP2.4] [F20-OP2.3] Applies to elements that support or are part of an environmental separator.
	[F80-OH1.1] Applies where concrete supports or is used in the walls of <i>chimneys</i> or fireplaces. [F80-OH1.1,OH1.2,OH1.3] Applies where concrete supports or is used in an environmental separator.
	[F80-OH4] Applies where concrete elements support wood-frame floors.
	[F80-OS3.1] Applies to concrete floors or steps, concrete that supports wood-frame floors or steps, and concrete steps that support <i>guards</i> or handrails. [F80-OS3.4,OS3.7] Applies where concrete supports or is used in <i>chimneys</i> or fireplaces.
	[F80-OS1.1] Applies where concrete is used in footings for <i>chimneys</i> or fireplaces.
<b>9.3.1.4. Aggregates</b>	
(1)	[F20-OS2.1] [F80-OS2.3] [F20-OS2.3] Applies to elements that support or are part of an environmental separator.
	[F20-OP2.1,OP2.4] [F80-OP2.3,OP2.4] [F20-OP2.3] Applies to elements that support or are part of an environmental separator.
	[F20,F80,F61,F55-OH1.1,OH1.2] Applies to elements that support or are part of an environmental separator and to masonry used in <i>chimneys</i> and fireplaces. [F20,F80,F61-OH1.3] Applies to elements that support or are part of an environmental separator and to masonry used in <i>chimneys</i> and fireplaces.
	[F20,F80-OS1.1] Applies to concrete used in <i>chimneys</i> or fireplaces.
	[F20,F80-OS3.1] Applies to floors and elements that support floors. [F20,F80-OS3.4] Applies to concrete used in <i>chimneys</i> or fireplaces.
	[F20,F80-OH4] Applies to floors and elements that support floors.
<b>9.3.1.5. Water</b>	
(1)	[F20-OS2.1] [F80-OS2.3] [F20-OS2.3] Applies to elements that support or are part of an environmental separator.

	<p>[F20-OP2.1,OP2.4] [F80-OP2.3,OP2.4] [F20-OP2.3] Applies to elements that support or are part of an environmental separator.</p>
	<p>[F20,F80,F61,F55-OH1.1,OH1.2] Applies to elements that support or are part of an environmental separator and to masonry used in <i>chimneys</i> and fireplaces. [F20,F80,F61-OH1.3] Applies to elements that support or are part of an environmental separator and to masonry used in <i>chimneys</i> and fireplaces.</p>
	<p>[F20,F80-OH4] Applies where concrete elements support wood-frame floors.</p>
	<p>[F20,F80-OS3.1] Applies to concrete floors or steps, concrete that supports wood-frame floors or steps, and concrete steps that support <i>guards</i> or handrails. [F20,F80-OS3.4,OS3.7] Applies where concrete supports or is used in <i>chimneys</i> or fireplaces.</p>
	<p>[F20,F80-OS1.1] Applies where concrete supports or is used in <i>chimneys</i> or fireplaces.</p>
<b>9.3.1.6. Compressive Strength</b>	
(1)	<p>(a) [F20-OS2.1] (a) [F21,F80-OS2.3] (a) [F20-OS2.3] Applies to elements that support or are part of an environmental separator.</p>
	<p>(a) [F20-OP2.1,OP2.4] (a) [F21-OP2.3,OP2.4] (a) [F80-OP2.3] (a) [F20-OP2.3] Applies to elements that support or are part of an environmental separator.</p>
	<p>(a) [F20,F80-OH1.1] Applies where concrete supports or is used in the walls of <i>chimneys</i> or fireplaces. (a) [F20,F80,F61,F55-OH1.1,OH1.2] [F20,F80,F61-OH1.3] Applies where concrete supports or is used in an environmental separator.</p>
	<p>(a) [F20,F21,F80-OH4] Applies to elements that support floors.</p>
	<p>(a) [F20,F80-OS3.1] Applies to elements that support floors or steps. (a) [F20,F80-OS3.4,OS3.7] Applies where concrete supports or is used in <i>chimneys</i> or fireplaces.</p>
	<p>(a) [F20,F21,F80-OS1.1] Applies where concrete supports or is used in <i>chimneys</i> or fireplaces.</p>
	<p>(b) [F20-OS2.1] (b) [F21,F80-OS2.3] (b) [F20-OS2.3] Applies to elements that support or are part of an environmental separator.</p>
	<p>(b) [F20-OP2.1,OP2.4] (b) [F21-OP2.3,OP2.4] (b) [F80-OP2.3] (b) [F20-OP2.3] Applies to elements that support or are part of an environmental separator.</p>
	<p>(b) [F20,F21,F80,F61,F55-OH1.1,OH1.2] [F20,F21,F80,F61-OH1.3]</p>
	<p>(b) [F20,F21,F80-OS3.1]</p>
	<p>(c) [F20-OS2.1] [F20,F21,F80-OS2.3]</p>
	<p>(c) [F20-OP2.1] [F20,F21,F80-OP2.3,OP2.4]</p>
	<p>(c) [F20,F21,F80-OS3.1]</p>
(2)	<p>[F80-OS3.1]</p>
<b>9.3.1.7. Concrete Mixes</b>	
(1)	<p>(a) [F20-OS2.1] (a) [F21-OS2.3] (a) [F20,F61,F55-OS2.3] Applies to elements that support or are part of an environmental separator.</p>
	<p>(a) [F20-OP2.1,OP2.4] (a) [F21-OP2.3,OP2.4] (a) [F20,F55,F61-OP2.3] Applies to elements that support or are part of an environmental separator.</p>



	<p>(a) [F20,F21,F80-OH1.1] Applies where concrete supports or is used in the walls of <i>chimneys</i> or fireplaces.</p> <p>(a) [F20,F21,F80,F61,F55-OH1.1,OH1.2] [F20,F21,F80,F61-OH1.3] Applies where concrete supports or is used in an environmental separator.</p>
	(a) [F20,F21,F61-OH4] Applies to elements that support floors.
	<p>(a) [F20,F21,F61-OS3.1] Applies to concrete floors or steps, concrete that supports wood-frame floors or steps, and concrete steps that support <i>guards</i> or handrails.</p> <p>(a) [F20,F21,F61-OS3.4,OS3.7] Applies where concrete supports or is used in <i>chimneys</i> or fireplaces.</p>
	(a) [F20,F21,F61-OS1.1] Applies where concrete supports or is used in <i>chimneys</i> or fireplaces.
	<p>(b) [F20-OS2.1]</p> <p>(b) [F21,F80-OS2.3]</p> <p>(b) [F20-OS2.3] Applies where concrete is used in an environmental separator.</p>
	<p>(b) [F20-OP2.1,OP2.4]</p> <p>(b) [F21-OP2.3,OP2.4]</p> <p>(b) [F80-OP2.3]</p> <p>(b) [F20-OP2.3] Applies where concrete is used in an environmental separator.</p>
	(b) [F20,F21,F80,F61,F55-OH1.1,OH1.2] [F20,F21,F80,F61-OH1.3]
	(b) [F20,F21,F80-OS3.1]
	(c) [F20,F21-OS2.1] [F20,F21,F80-OS2.3]
	(c) [F20,F21,F80-OS3.1]
	(c) [F20,F21,F80-OP2.3,OP2.4]
(2)	<p>[F20-OS2.1]</p> <p>[F21-OS2.3]</p> <p>[F20,F61,F55-OS2.3] Applies to elements that support or are part of an environmental separator.</p>
	<p>[F20-OP2.1,OP2.4]</p> <p>[F21-OP2.3,OP2.4]</p> <p>[F20,F61,F55-OP2.3] Applies where concrete supports or is used in an environmental separator.</p>
	<p>[F20,F21,F61,F55-OH1.1] Applies where concrete supports or is used in the walls of <i>chimneys</i> or fireplaces.</p> <p>[F20,F21-OH1.2,OH1.3] Applies where concrete supports or is used in an environmental separator.</p>
	[F20,F21,F61,F55-OH4] Applies where concrete elements support wood-frame floors.
	<p>[F20,F80-OS3.1] Applies to concrete floors or steps, concrete that supports wood-frame floors or steps, and concrete steps that support <i>guards</i> or handrails.</p> <p>[F20,F80-OS3.4,OS3.7] Applies where concrete supports or is used in <i>chimneys</i> or fireplaces.</p>
	[F20,F21-OS1.1] Applies where concrete supports or is used in <i>chimneys</i> or fireplaces.
<b>9.3.1.8. Admixtures</b>	
(1)	<p>[F20-OS2.1]</p> <p>[F21-OS2.3]</p> <p>[F20,F61,F55-OS2.3] Applies to elements that support or are part of an environmental separator.</p>
	<p>[F20-OP2.1,OP2.4]</p> <p>[F21-OP2.3,OP2.4]</p> <p>[F80-OP2.3,OP2.4]</p> <p>[F20-OP2.3] Applies to elements that support or are part of an environmental separator.</p>
	<p>[F20,F80-OH1.1] Applies where concrete supports or is used in the walls of <i>chimneys</i> or fireplaces.</p> <p>[F20,F80,F61,F55-OH1.1,OH1.2] [F20,F80,F61-OH1.3] Applies where concrete supports or is used in an environmental separator.</p>
	[F20,F21,F80-OH4] Applies where concrete elements support wood-frame floors.

	[F20,F80-OS3.1] Applies to concrete floors or steps, concrete that supports wood-frame floors or steps, and concrete steps that support <i>guards</i> or handrails. [F20,F80-OS3.4,OS3.7] Applies where concrete supports or is used in <i>chimneys</i> or fireplaces.
	[F20,F21,F80-OS1.1] Applies where concrete supports or is used in <i>chimneys</i> or fireplaces.
<b>9.3.1.9. Cold Weather Requirements</b>	
(1)	[F20-OS2.1] [F21-OS2.3] [F20-OS2.3] Applies to elements that support or are part of an environmental separator.
	[F20-OP2.1,OP2.4] [F21,F80-OP2.3,OP2.4] [F20-OP2.3] Applies to elements that support or are part of an environmental separator.
	[F20,F80-OH1.1] Applies where concrete supports or is used in the walls of <i>chimneys</i> or fireplaces. [F20,F80,F61,F55-OH1.1,OH1.2] [F20,F80,F61-OH1.3] Applies where concrete supports or is used in an environmental separator.
	[F20,F21,F80-OH4] Applies where concrete elements support wood-frame floors.
	[F20,F80-OS3.1] Applies to concrete floors or steps, concrete that supports wood-frame floors or steps, and concrete steps that support <i>guards</i> or handrails. [F20,F80-OS3.4,OS3.7] Applies where concrete supports or is used in <i>chimneys</i> or fireplaces.
	[F20,F21,F80-OS1.1] Applies where concrete supports or is used in <i>chimneys</i> or fireplaces.
(2)	[F20-OH1.1] Applies where concrete supports or is used in the walls of <i>chimneys</i> or fireplaces. [F20,F61,F55-OH1.1,OH1.2] [F20,F61-OH1.3] Applies where concrete supports or is used in an environmental separator.
	[F20-OS2.1] [F20,F61,F55-OS2.3] Applies to elements that support or are part of an environmental separator.
	[F20-OP2.1,OP2.4] [F20,F61,F55-OP2.3] [F61,F55-OP2.4] Applies to elements that support or are part of an environmental separator.
	[F20-OS1.1] Applies to concrete that supports or is used in <i>chimneys</i> or fireplaces.
	[F20,F61,F55-OS3.1] Applies to floors and elements that support floors. [F20,F61,F55-OS3.4] Applies to concrete that supports or is used in <i>chimneys</i> or fireplaces.
	[F20,F61,F55-OH4] Applies to elements that support floors.
<b>9.3.2.2. Lumber Grades</b>	
(1)	[F20-OS2.1] [F20,F22-OS2.3] Applies to elements that support or are part of an environmental separator.
	[F20-OP2.1,OP2.4] [F22-OP2.4] [F20,F22-OP2.3] Applies to elements that support or are part of an environmental separator.
	[F22-OS3.1] Applies to floors and elements that support floors. [F22-OS3.7] Applies to walls, or elements that support walls, that contain doors or windows required for emergency egress.
	[F20,F22-OH1.1,OH1.2,OH1.3] Applies to elements that support or are part of an environmental separator.
	[F20,F22-OS1.2] Applies to assemblies required to provide fire resistance.
	[F20,F22-OH4] Applies to floors and elements that support floors.
<b>9.3.2.5. Moisture Content</b>	
(1)	[F21,F80-OS2.3]

	[F21,F80-OP2.3,OP2.4]
	[F21,F80-OS3.1] Applies to floors and elements that support floors.
	[F21,F80-OH1.1,OH1.2,OH1.3] Applies to elements that support or are part of an environmental separator.
	[F21,F80-OS1.2] Applies to assemblies required to provide fire resistance.
	[F21,F80-OH4] Applies to floors and elements that support floors.
<b>9.3.2.8. Undersized Lumber</b>	
(1)	[F20-OS2.1] [F20,F22-OS2.3] Applies to elements that support or are part of an environmental separator.
	[F20-OP2.1,OP2.4] [F22-OP2.4] [F20,F22-OP2.3] Applies to elements that support or are part of an environmental separator.
	[F20,F22-OH4] Applies to floors and elements that support floors.
	[F20,F22-OH1.1,OH1.2,OH1.3] Applies to elements that support or are part of an environmental separator.
	[F20,F22-OS1.2] Applies to assemblies required to provide fire resistance.
	[F20,F22-OS3.1] Applies to floors and elements that support floors.
<b>9.3.2.9. Termite and Decay Protection</b>	
(1)	[F82,F80-OS2.3]
	[F82,F80-OP2.3,OP2.4]
	[F82,F80,F61,F55-OH1.1,OH1.2] [F82,F80,F61-OH1.3] Applies where structural wood elements support or are used in an environmental separator.
	[F82,F80-OH4] Applies where structural wood elements support or are used in floors.
	[F82,F80-OS3.1] Applies where structural wood elements support or are used in floors.
	[F82,F80-OS1.2] Applies where structural wood elements support or are used in assemblies that are required to provide fire resistance.
(2)	[F80,F82-OS2.3]
	[F80,F82-OP2.3,OP2.4]
	[F82,F80,F61,F55-OH1.1,OH1.2] [F82,F80,F61-OH1.3] Applies where structural wood elements support or are used in an environmental separator.
	[F82,F80-OH4] Applies where structural wood elements support or are used in floors.
	[F82,F80-OS3.1] Applies where structural wood elements support or are used in floors.
	[F82,F80-OS1.2] Applies where structural wood elements support or are used in assemblies that are required to provide fire resistance.
(3)	[F80-OS2.3]
	[F80-OP2.3,OP2.4]
	[F82,F80,F61,F55-OH1.1,OH1.2] [F82,F80,F61-OH1.3] Applies where structural wood elements support or are used in an environmental separator.
	[F80-OH4] Applies where structural wood elements support or are used in floors.
	[F80-OS3.1] Applies where structural wood elements support or are used in floors.

	[F80-OS1.2] Applies where structural wood elements support or are used in assemblies that are required to provide fire resistance.
(4)	[F80-OS2.3,OS2.5]
	[F80-OP2.3,OP2.4,OP2.5]
	[F80,F61,F55-OH1.1,OH1.2] [F80,F61-OH1.3] Applies where cribbing or retaining walls support an environmental separator.
	[F80-OH4] Applies to floors and elements that support floors.
	[F80-OS3.1] Applies where cribbing or retaining walls support floors.
	[F80-OS1.2] Applies where cribbing or retaining walls support assemblies that are required to provide fire resistance.
(5)	[F80,F81-OS2.3,OS2.4]
	[F80,F81-OP2.3,OP2.4]
	[F55,F61,F80,F81-OH1.1,OH1.2] [F61,F80,F81-OH1.3] Applies where structural wood elements support or are used in an environmental separator.
	[F80,F81-OH4] Applies where structural wood elements support wood-frame floors.
	[F80,F81-OS3.1] Applies where structural wood elements support or are used in floors.
	[F80,F81-OS1.2] Applies where structural wood elements support or are used in assemblies that are required to provide fire resistance.
(6)	[F20,F60-OS2.3]
	[F20,F61-OP2.3,OP2.4]
	[F20,F55,F61-OH1.1,OH1.2] [F20,F61-OH1.3] Applies where structural wood elements support or are used in an environmental separator.
	[F61,F80-OH4] Applies to floors and elements that support floors.
	[F20,F61-OS3.1] Applies where structural wood elements support or are used in floors.
	[F80,F81-OS1.2] Applies where structural wood elements support or are used in assemblies that are required to provide fire resistance.
<b>9.3.3.2. Galvanized Sheet Steel</b>	
(1)	[F80-OS2.3]
	[F80-OP2.3,OP2.4]
	[F80-OH1.1,OH1.2,OH1.3] Applies where sheet metal is used in an environmental separator.
	[F80-OS3.1] Applies where sheet metal is used in assemblies that support floors.
	[F80-OH4] Applies where sheet metal is used in assemblies that support floors.
(2)	[F80-OS2.3]
	[F80-OP2.3]
	[F80-OH1.1,OH1.2,OH1.3]
<b>9.4.2.2. Specified Snow Loads</b>	
(1)	[F20-OS2.1,OS2.3] [F22-OS2.3]
	[F20-OP2.1,OP2.3] [F22-OP2.3]
	[F22-OH1.1,OH1.2,OH1.3]
(2)	[F20-OS2.1]

	[F20-OP2.1]
(4)	[F20-OS2.1,OS2.3] [F22-OS2.3]
	[F20-OP2.1,OP2.3] [F22-OP2.3]
	[F22-OH1.1,OH1.2,OH1.3]
<b>9.4.2.3. Platforms Subject to Snow and Occupancy Loads</b>	
(1)	[F20-OS2.1]
	[F20-OP2.1]
<b>9.4.2.4. Attics and Roof Spaces</b>	
(1)	[F20-OS2.1]
	[F20-OP2.1]
<b>9.4.3.1. Deflections</b>	
(1)	[F22-OS2.3] Applies to elements that support or are part of an environmental separator.
	[F22-OP2.1,OP2.4] [F22-OP2.3] Applies to elements that support or are part of an environmental separator.
	[F22-OH4]
	[F22-OS3.1] Applies to floors and elements that support floors. [F22-OS3.7] Applies to walls, and elements that support walls, that contain doors or windows required for emergency egress.
	[F22-OH1.1,OH1.2,OH1.3] Applies to elements that support or are part of an environmental separator.
<b>9.4.4.1. Allowable Bearing Pressures</b>	
(1)	[F20-OS2.2] [F20-OS2.3] Applies to elements that support or are part of an environmental separator.
	[F20-OP2.2,OP2.4] [F20-OP2.3] Applies to elements that support or are part of an environmental separator.
	[F20-OH1.1,OH1.2,OH1.3] Applies to footings that support an environmental separator.
	[F20-OH4] Applies to footings that support floors and other elements that support floors.
	[F20-OS3.1] Applies to footings that support floors and other elements that support floors. [F20-OS3.7] Applies to footings that support walls that contain doors or windows required for emergency egress.
<b>9.4.4.2. Foundation Capacity in Weaker Soil and Rock</b>	
(1)	[F20-OS2.2] [F20-OS2.3] Applies to elements that support or are part of an environmental separator.
	[F20-OP2.2,OP2.4] [F20-OP2.3] Applies to elements that support or are part of an environmental separator.
	[F20-OH1.1,OH1.2,OH1.3] Applies to elements that support or are part of an environmental separator.
	[F20-OH4] Applies to floors and elements that support floors.
	[F20-OS3.1] Applies to floors and elements that support floors.
(2)	[F20-OS2.2] [F20-OS2.3] Applies to elements that support or are part of an environmental separator.
	[F20-OP2.2,OP2.4] [F20-OP2.3] Applies to elements that support or are part of an environmental separator.

	[F20-OH1.1,OH1.2,OH1.3] Applies to elements that support or are part of an environmental separator.
	[F20-OH4] Applies to floors and elements that support floors.
	[F20-OS3.1] Applies to floors and elements that support floors.
<b>9.4.4.3. High Water Table</b>	
(1)	[F20-OS2.2] [F20-OS2.3] Applies to elements that support or are part of an environmental separator.
	[F20-OP2.2,OP2.4] [F20-OP2.3] Applies to elements that support or are part of an environmental separator.
	[F20-OH1.1,OH1.2,OH1.3] Applies to elements that support or are part of an environmental separator.
	[F20-OH4] Applies to floors and elements that support floors.
	[F20-OS3.1] Applies to floors and elements that support floors.
<b>9.4.4.4. Soil Movement</b>	
(1)	[F21-OS2.1] [F21-OS2.3] Applies to elements that support or are part of an environmental separator.
	[F21-OP2.1,OP2.4] [F21-OP2.3] Applies to elements that support or are part of an environmental separator.
	[F21-OH1.1,OH1.2,OH1.3] Applies to walls that support or are part of an environmental separator.
	[F21-OH4] Applies to <i>foundations</i> that support floors and other elements that support floors.
	[F21-OS3.1] Applies to footings that support floors and other elements that support floors. [F21-OS3.7] Applies to footings that support walls that contain doors or windows required for emergency egress.
<b>9.4.4.5. Retaining Walls</b>	
(1)	[F20-OS2.1,OS2.3]
	[F20-OP2.1,OP2.3,OP2.4]
	[F20-OH1.1,OH1.2,OH1.3]
	[F20-OH4] Applies to floors and elements that support floors.
	[F20-OS3.1] Applies to floors and elements that support floors.
<b>9.4.4.6. Walls Supporting Drained Earth</b>	
(1)	[F20-OS2.1,OS2.3]
	[F20-OP2.1,OP2.3,OP2.4]
	[F20-OH1.1,OH1.2,OH1.3]
	[F20-OH4] Applies to floors and elements that support floors.
	[F20-OS3.1] Applies to floors and elements that support floors. [F20-OS3.7] Applies to walls, and elements that support walls, that contain doors or windows required for emergency egress.
(2)	[F20-OS2.1,OS2.3]
	[F20-OP2.1,OP2.3,OP2.4]
	[F20-OH1.1,OH1.2,OH1.3]
	[F20-OH4] Applies to floors and elements that support floors.

	[F20-OS3.1] Applies to floors and elements that support floors. [F20-OS3.7] Applies to walls, and elements that support walls, that contain doors or windows required for emergency egress.
<b>9.5.1.2. Combination Rooms</b>	
(2)	[F10-OS3.7]
<b>9.5.3.1. Ceiling Heights of Rooms or Spaces</b>	
(3)	[F30-OS3.1] [F10-OS3.7]
(4)	[F30-OS3.1] [F10-OS3.7]
<b>9.5.3.2. Mezzanines</b>	
(1)	[F30-OS3.1] [F10-OS3.7]
<b>9.5.3.3. Storage Garages</b>	
(1)	[F30-OS3.1] [F10-OS3.7]
<b>9.5.4.1. Hallway Width</b>	
(1)	[F10-OS3.7]
<b>9.5.5.1. Doorway Opening Sizes</b>	
(2)	[F10-OS3.7] [F30-OS3.1]
<b>9.5.5.2. Doorways to Public Water-Closet Rooms</b>	
(1)	[F30-OS3.1] [F10-OS3.7]
<b>9.5.5.3. Doorways to Rooms with a Bathtub, Shower or Water Closet</b>	
(2)	[F74-OA2]
<b>9.6.1.2. Material Standards for Glass</b>	
(1)	[F20-OS2.1] [F63-OS2.3]
	(e),(i) [F63-OH1.1] [F51,F63-OH1.2]
	(h) [F03-OS1.2]
(2)	[F30-OS3.1] [F10-OS3.7]
<b>9.6.1.3. Structural Sufficiency of Glass</b>	
(1)	[F20-OS2.1]
(3)	[F30-OS3.1] [F10-OS3.7]
<b>9.6.1.4. Types of Glazing and Protection of Glazing</b>	
(1)	[F30-OS3.1] [F10-OS3.7]
(3)	[F30-OS3.1] [F10-OS3.7]
(4)	[F30-OS3.1] [F10-OS3.7] Applies to portion of Code text: "... except that such <i>partitions</i> shall be suitably marked to indicate their existence and position."
(5)	[F30-OS3.1] [F10-OS3.7]
(6)	[F20,F30-OS3.1]
<b>9.7.2.1. Entrance Doors</b>	
(1)	[F42-OH2.5]
	[F51,F54-OH1.2] [F40,F61,F42-OH1.1]

	[F61,F42-OS2.3]
(2)	[F35-OS4.2]
<b>9.7.3.1. General Performance Expectations</b>	
(2)	[F81-OH1.1] Applies to skylights that provide required non-heating season ventilation. [F20,F22-OH1.3]
	[F20-OS2.1,OS2.3]
<b>9.7.3.2. Heat Transfer Performance</b>	
(1)	[F51,F63-OH1.1,OH1.2]
	[F63-OS2.3]
<b>9.7.3.3. Thermal Characteristics of Windows, Doors and Skylights</b>	
(1)	[F63-OH1.1,OH1.2,OH1.3]
	[F63-OS2.3]
(3)	[F63-OH1.1,OH1.2,OH1.3]
	[F63-OS2.3]
(4)	[F63-OH1.1,OH1.2,OH1.3]
	[F63-OS2.3]
	[F63-OS3.1]
<b>9.7.4.2. General</b>	
(1)	[F20,F55,F61,F62,F63-OH1.1] [F81-OH1.1] Applies to windows that provide required non-heating season ventilation. [F54,F55,F61,F62,F63-OH1.2] [F20,F61,F62,F63-OH1.3]
	[F20,F21,F61-OS2.3]
	[F10-OS1.5] Applies where windows, doors or skylights serve bedrooms, except bedrooms that have direct access to the exterior through an <i>exit</i> door or bedrooms that are in <i>sprinklered suites</i> .
<b>9.7.4.3. Performance Requirements</b>	



(1)	[F20,F55,F61-OH1.1] [F55-OH1.2] [F20,F61,F62-OH1.3]
<b>9.7.5.2. Resistance to Forced Entry for Swinging Doors</b>	
(2)	[F34-OS4.1]
(3)	[F20-OS4.1]
(4)	[F34-OS4.1]
(5)	[F34-OS4.1]
(6)	[F20-OS4.1]
(7)	[F20-OS4.1]
(8)	[F34-OS4.1]
(9)	[F20-OS4.1]
<b>9.7.5.3. Resistance to Forced Entry for Windows</b>	
(1)	[F34-OS4.1]
<b>9.7.6.1. Installation of Windows, Doors and Skylights</b>	
(1)	[F20,F54,F55,F61,F63-OH1.1,OH1.2,OH1.3]
	[F20,F61,F63-OS2.3]
(2)	[F54,F55,F61,F63-OH1.1,OH1.2,OH1.3]
	[F61,F63-OS2.3]
(3)	[F55,F61,F63-OS2.3]
	[F55,F61,F63-OH1.1,OH1.2,OH1.3]
<b>9.7.6.2. Sealants, Trim and Flashing</b>	
(1)	[F61,F63-OH1.1,OH1.3] [F51,F54,F61,F63-OH1.2]
	[F61,F63-OS2.3]
(4)	[F80-OS2.1,OS2.3]
	[F80-OP2.1,OP2.3]
	[F80-OH1.1,OH1.2,OH1.3]
<b>9.8.2.1. Stair Width</b>	
(1)	[F30-OS3.1] [F10-OS3.7]
(2)	[F30-OS3.1] [F10-OS3.7]
(3)	[F30-OS3.1] [F10-OS3.7]
(4)	[F30-OS3.1] [F10-OS3.7]
<b>9.8.2.2. Height over Stairs</b>	

(2)	[F30-OS3.1] [F10-OS3.7]
(3)	[F30-OS3.1] [F10-OS3.7]
<b>9.8.3.1. Permitted Configurations</b>	
(1)	[F30-OS3.1] [F10-OS3.7]
(2)	[F10-OS3.7]
(3)	[F30-OS3.1] [F10-OS3.7]
(4)	[F30-OS3.1] [F10-OS3.7]
(5)	[F30-OS3.1] [F10-OS3.7]
<b>9.8.3.2. Minimum Number of Risers</b>	
(1)	[F30-OS3.1] [F10-OS3.7]
<b>9.8.3.3. Maximum Height of Stairs</b>	
(1)	[F30-OS3.1]
<b>9.8.4.1. Dimensions for Risers</b>	
(1)	[F30-OS3.1] [F10-OS3.7]
<b>9.8.4.2. Dimensions for Rectangular Treads</b>	
(1)	[F30-OS3.1] [F10-OS3.7]
(2)	[F30-OS3.1] [F10-OS3.7]
<b>9.8.4.3. Dimensions of Tapered Treads</b>	
(1)	[F30-OS3.1] [F10-OS3.7]
(3)	[F30-OS3.1] [F10-OS3.7]
<b>9.8.4.4. Uniformity and Tolerances for Risers, Runs and Treads</b>	
(1)	[F30-OS3.1] [F10-OS3.7]
(2)	[F30-OS3.1] [F10-OS3.7]
(3)	[F30-OS3.1] [F10-OS3.7]
(4)	[F30-OS3.1] [F10-OS3.7]
(5)	[F30-OS3.1] [F10-OS3.7]
<b>9.8.4.6. Winders</b>	
(1)	[F30-OS3.1] [F10-OS3.7]
(2)	[F30-OS3.1] [F10-OS3.7]
<b>9.8.4.8. Tread Nosings</b>	
(1)	[F30-OS3.1] [F10-OS3.7]
(2)	[F30-OS3.1] [F10-OS3.7]
<b>9.8.4.9. Open Risers</b>	
(1)	[F30-OS3.1]
<b>9.8.5.2. Ramp Width</b>	
(1)	[F30-OS3.1] [F10-OS3.7]
(2)	[F30-OS3.1] [F10-OS3.7]

<b>9.8.5.3. Height over Ramps</b>	
(1)	[F30-OS3.1] [F10-OS3.7]
(2)	[F30-OS3.1] [F10-OS3.7]
<b>9.8.5.4. Ramp Slope</b>	
(1)	[F30-OS3.1] [F10-OS3.7]
<b>9.8.5.5. Maximum Rise</b>	
(1)	[F30-OS3.1]
<b>9.8.6.2. Required Landings</b>	
(1)	[F30-OS3.1] [F10-OS3.7]
<b>9.8.6.3. Dimensions of Landings</b>	
(1)	[F30-OS3.1] [F10-OS3.7]
(2)	[F30-OS3.1] [F10-OS3.7]
(4)	[F30-OS3.1] [F10-OS3.7]
(5)	[F30-OS3.1] [F10-OS3.7]
(6)	[F30-OS3.1] [F10-OS3.7]
(7)	[F30-OS3.1] [F10-OS3.7]
<b>9.8.6.4. Height over Landings</b>	
(1)	[F30-OS3.1] [F10-OS3.7]
(2)	[F30-OS3.1] [F10-OS3.7]
<b>9.8.7.1. Required Handrails</b>	
(1)	[F30-OS3.1] [F10-OS3.7]
(2)	[F10-OS3.7] [F30-OS3.1]
(5)	[F30-OS3.1] [F10-OS3.7]
<b>9.8.7.2. Continuity of Handrails</b>	
(1)	[F30-OS3.1] [F10-OS3.7]
(2)	[F30-OS3.1] [F10-OS3.7]
	[F73-OA1]
<b>9.8.7.3. Termination of Handrails</b>	
(1)	[F30-OS3.1] [F10-OS3.7]
(2)	[F30-OS3.1] [F10-OS3.7]
<b>9.8.7.4. Height of Handrails</b>	
(2)	[F30-OS3.1] [F10-OS3.7]
<b>9.8.7.5. Ergonomic Design</b>	
(1)	[F30-OS3.1] [F10-OS3.7]
(2)	[F30-OS3.1] [F10-OS3.7]
<b>9.8.7.6. Projections into Stairs and Ramps</b>	
(1)	[F30-OS3.1] [F10-OS3.7]

<b>9.8.7.7. Design and Attachment of Handrails</b>	
(1)	[F20-OS2.1]
	[F20-OS3.1,OS3.7]
(2)	[F20-OS2.1]
	[F20-OS3.1,OS3.7]
<b>9.8.8.1. Required Guards</b>	
(1)	[F30-OS3.1] [F10-OS3.7]
(3)	[F30-OS3.1] [F10-OS3.7]
(4)	[F30-OS3.1]
(6)	[F30-OS3.1] [F10-OS3.7]
(7)	[F30-OS3.1] [F10-OS3.7]
(8)	[F30-OS3.1]
<b>9.8.8.2. Loads on Guards</b>	
(1)	[F20-OS2.1]
(2)	[F22-OS2.4]
<b>9.8.8.3. Height of Guards</b>	
(1)	[F30-OS3.1] [F10-OS3.7]
(2)	[F30-OS3.1] [F10-OS3.7]
(3)	[F30-OS3.1] [F10-OS3.7]
<b>9.8.8.4. Guards for Floors and Ramps in Garages</b>	
(1)	[F10-OS3.1]
(2)	[F20-OS2.1]
<b>9.8.8.5. Openings in Guards</b>	
(1)	[F30-OS3.1]
(2)	[F30-OS3.1]
(3)	[F30-OS3.1]
(4)	[F30-OS3.1]
<b>9.8.8.6. Design of Guards to Not Facilitate Climbing</b>	
(1)	[F30-OS3.1]
<b>9.8.8.7. Glass in Guards</b>	
(1)	[F20-OS3.1,OS3.7]
	[F20-OS2.1]
<b>9.8.9.1. Loads on Stairs and Ramps</b>	
(1)	[F20-OS2.1]
	[F22-OH4]
<b>9.8.9.2. Exterior Concrete Stairs</b>	
(1)	[F22-OS3.1,OS3.7]

<b>9.8.9.3. Exterior Wood Steps</b>	
(1)	[F80-OS3.1,OS3.7]
	[F80-OS2.3]
<b>9.8.9.4. Wooden Stair Stringers</b>	
(1)	[F20-OS2.1]
	[F22-OH4]
(2)	[F22-OH4]
	[F20-OS2.1]
<b>9.8.9.5. Treads</b>	
(1)	[F22-OH4]
	[F20-OS2.1]
(2)	[F22-OH4]
	[F20-OS2.1]
<b>9.8.9.6. Finish for Treads and Landings</b>	
(1)	[F30-OS3.1] [F10-OS3.7]
(2)	[F30-OS3.1] [F10-OS3.7]
<b>9.8.10.1. Design</b>	
(1)	[F22-OS3.1,OS3.7]
	[F20-OS2.1]
<b>9.8.10.2. Anchorage</b>	
(1)	[F20-OS2.1]
	[F22-OS3.1,OS3.7]
	[F20-OH1.1,OH1.2,OH1.3]
<b>9.8.10.3. Prevention of Damage Due to Frost</b>	
(1)	[F21-OS3.1]
	[F21-OS2.1]
	[F21-OH1.1,OH1.2,OH1.3]
<b>9.9.1.3. Occupant Load</b>	
(1)	[F10-OS3.7]
(2)	[F10-OS3.7]
<b>9.9.2.2. Purpose of Exits</b>	
(1)	[F10-OS3.7] Applies to "An <i>exit</i> shall be designed for no purpose other than for exiting ..."
<b>9.9.2.3. Elevators, Slide Escapes and Windows as Means of Egress</b>	
(1)	[F10-OS3.7]
<b>9.9.2.4. Principal Entrances</b>	
(1)	[F10-OS3.7]
<b>9.9.3.2. Exit Width</b>	

(1)	[F10-OS3.7]
<b>9.9.3.3. Width of Corridors</b>	
(1)	[F30-OS3.1] [F10-OS3.7]
<b>9.9.3.4. Clear Height</b>	
(1)	[F30-OS3.1] [F10-OS3.7]
(2)	[F30-OS3.1] [F10-OS3.7]
<b>9.9.4.2. Fire Separations for Exits</b>	
(1)	[F05-OS1.5] [F03-OS1.2]
	[F03-OP1.2]
(2)	[F03-OS1.2] [F05-OS1.5]
	[F03-OP1.2]
(3)	[F05-OS1.5]
(4)	[F05-OS1.5] [F03-OS1.2]
	[F03-OP1.2]
<b>9.9.4.3. Wired Glass or Glass Block</b>	
(2)	[F05-OS1.5]
<b>9.9.4.4. Openings Near Unenclosed Exterior Exit Stairs and Ramps</b>	
(1)	[F05-OS1.5]
<b>9.9.4.5. Openings in Exterior Walls of Exits</b>	
(1)	[F05-OS1.5]
<b>9.9.4.6. Openings Near Exit Doors</b>	
(1)	[F05-OS1.5]
<b>9.9.4.7. Stairways in 2 Storey, Group D or E Buildings</b>	
(1)	[F05-OS1.5]
<b>9.9.5.2. Occupancies in Corridors</b>	
(1)	[F10-OS3.7]
<b>9.9.5.3. Obstructions in Public Corridors</b>	
(1)	[F30-OS3.1]
<b>9.9.5.4. Obstructions in Exits</b>	
(1)	[F10-OS3.7]
<b>9.9.5.5. Obstructions in Means of Egress</b>	
(1)	[F10-OS3.7]
(2)	[F10-OS3.7]
<b>9.9.5.6. Mirrors or Draperies</b>	
(1)	[F10-OS3.7] [F30-OS3.1]
<b>9.9.5.7. Fuel-Fired Appliances</b>	
(1)	[F10-OS1.5]

	[F10-OS3.7]
<b>9.9.5.8. Service Rooms</b>	
(1)	[F10-OS3.7] [F30-OS3.1]
<b>9.9.5.9. Ancillary Rooms</b>	
(1)	[F05,F06-OS1.5]
	[F10-OS3.7]
<b>9.9.6.1. Obstructions by Doors</b>	
(2)	[F30-OS3.1] [F10-OS3.7]
(3)	[F30-OS3.1] [F10-OS3.7]
<b>9.9.6.2. Clear Opening Height at Doorways</b>	
(1)	[F30-OS3.1] [F10-OS3.7]
(2)	[F30-OS3.1] [F10-OS3.7]
<b>9.9.6.3. Clear Opening Width at Doorways</b>	
(2)	[F30-OS3.1] [F10-OS3.7]
(3)	[F30-OS3.1] [F10-OS3.7]
<b>9.9.6.4. Door Action</b>	
(1)	[F10-OS3.7]
(2)	[F10-OS3.7]
<b>9.9.6.5. Direction of Door Swing</b>	
(1)	[F10-OS3.7]
(2)	[F10-OS3.7]
(3)	[F10-OS3.7]
(4)	[F10-OS3.7]
<b>9.9.6.6. Nearness of Doors to Stairs</b>	
(1)	[F30-OS3.1] [F10-OS3.7]
(2)	[F10-OS3.7]
<b>9.9.6.7. Door Latching, Locking and Opening Mechanisms</b>	
(1)	(a) [F10-OS3.7]
	(b) [F10,F81-OS3.7]
(2)	[F10-OS3.7]
(3)	[F10-OS3.7]
	[F73-OA1]
(4)	[F10-OS3.7]
<b>9.9.6.8. Effort Required to Open</b>	
(1)	[F10-OS3.7]
<b>9.9.7.1. Egress from Roof Area, Podiums, Terraces, Platforms and Contained Open Spaces</b>	
(1)	[F10-OS3.7]

(2)	[F10-OS3.7]
<b>9.9.7.2. Means of Egress from Suites</b>	
(1)	[F10-OS1.5]
(2)	[F10-OS3.7]
<b>9.9.7.3. Dead-End Corridors</b>	
(1)	[F10-OS3.7]
<b>9.9.7.4. Number and Spacing of Egress Doors</b>	
(1)	[F10-OS3.7]
(2)	[F10-OS1.5]
<b>9.9.7.5. Independent Access to Exit</b>	
(1)	[F10-OS3.7]
<b>9.9.8.2. Number of Required Exits</b>	
(1)	[F10-OS3.7]
<b>9.9.8.3. Contribution of Each Exit</b>	
(1)	[F10-OS3.7]
<b>9.9.8.4. Location of Exits</b>	
(1)	[F10-OS1.5]
<b>9.9.8.5. Exiting through a Lobby</b>	
(1)	[F10-OS1.5]
(2)	[F10-OS1.5]
(3)	[F10-OS1.5]
(4)	[F10-OS1.5]
(5)	[F05-OS1.5]
<b>9.9.8.6. Mezzanine Means of Egress</b>	
(1)	[F05-OS1.5]
(4)	[F05-OS1.5]
<b>9.9.9.1. Travel Limit to Exits or Egress Doors</b>	
(1)	[F10-OS3.7]
(2)	[F10-OS3.7]
(3)	[F10-OS3.7]
<b>9.9.9.2. Two Separate Exits</b>	
(1)	[F10-OS3.7]
<b>9.9.9.3. Shared Egress Facilities</b>	
(1)	[F10-OS3.7]
(2)	[F10-OS3.7]
<b>9.9.10.1. Egress Windows or Doors for Bedrooms</b>	
(1)	[F10-OS3.7]



(2)	[F10-OS3.7]
(3)	[F10-OS3.7]
(4)	[F10-OS3.7]
(5)	[F10-OS3.7]
<b>9.9.11.2. Visibility of Exits</b>	
(1)	[F10-OS3.7]
(2)	[F10-OS3.7]
<b>9.9.11.3. Exit Signs</b>	
(1)	[F10-OS3.7]
(2)	[F10-OS3.7]
(3)	[F10,F81-OS3.7]
(4)	[F10,F81-OS3.7]
(5)	[F10-OS3.7]
(6)	[F10-OS3.7]
<b>9.9.11.4. Signs for Stairs and Ramps at Exit Level</b>	
(1)	[F10-OS3.7]
<b>9.9.11.5. Floor Numbering</b>	
(1)	[F10-OS3.7]
	[F73-OA1]
<b>9.9.12.2. Required Lighting in Egress Facilities</b>	
(1)	[F30-OS3.1] [F10-OS3.7]
(2)	[F30-OS3.1] [F10-OS3.7]
<b>9.9.12.3. Emergency Lighting</b>	
(1)	[F30-OS3.1] [F10-OS3.7]
(2)	[F30-OS3.1] [F10-OS3.7]
(3)	[F30-OS3.1] [F10-OS3.7]
(4)	[F30-OS3.1] [F10-OS3.7]
(5)	[F30-OS3.1] [F10-OS3.7]
(7)	[F30-OS3.1] [F10-OS3.7]
<b>9.10.1.2. Testing of Integrated Fire Protection and Life Safety Systems</b>	
(1)	[F02,F81,F82-OS1.2,OS1.5]
	[F02,F81,F82-OP1.2]
<b>9.10.1.3. Items under Part 3 Jurisdiction</b>	
(5)	[F01-OS1.1] Applies to portion of Code text: " ... facilities for the dispensing of fuel shall not be installed in any <i>building</i> ."
<b>9.10.2.2. Home-Type Care Occupancies</b>	
(2)	[F10-OS1.5]

<b>9.10.3.4. Suspended Membrane Ceilings</b>	
(1)	[F04-OS1.3]
	[F04-OP1.3]
<b>9.10.4.3. Basement Storage Garages</b>	
(1)	[F03-OS1.2]
	[F03-OP1.2]
<b>9.10.5.1. Permitted Openings in Wall and Ceiling Membranes</b>	
(1)	[F03-OS1.2] [F04-OS1.3]
	[F03-OP1.2] [F04-OP1.3]
(2)	[F04-OS1.3]
	[F04-OP1.3]
(3)	[F04-OS1.2,OS1.3]
	[F04-OP1.3]
<b>9.10.7.1. Protection of Steel Members</b>	
(1)	[F03-OS1.2] [F04-OS1.3]
	[F03-OP1.2] [F04-OP1.3]
<b>9.10.8.1. Fire-Resistance Ratings for Floors and Roofs</b>	
(1)	[F03-OS1.2] [F04-OS1.2,OS1.3] Applies to portion of Code text: "Except as otherwise provided in this Subsection, the <i>fire-resistance ratings</i> of floors and roofs shall conform to Table 9.10.8.1."
	[F03-OP1.2] [F04-OP1.2,OP1.3] Applies to portion of Code text: "Except as otherwise provided in this Subsection, the <i>fire-resistance ratings</i> of floors and roofs shall conform to Table 9.10.8.1."
<b>9.10.8.2. Fire-Resistance Ratings in Sprinklered Buildings</b>	
(1)	(a),(b) [F02,F82-OS1.3] [F13-OS1.5,OS1.2]
	(a),(b) [F02,F82-OP1.3] [F13-OP1.2]
<b>9.10.8.3. Fire-Resistance Ratings for Walls, Columns and Arches</b>	
(1)	[F04-OS1.2,OS1.3]
	[F04-OP1.2,OP1.3]
(2)	[F04-OS1.2,OS1.3]
	[F04-OP1.2,OP1.3]
<b>9.10.8.4. Support of Noncombustible Construction</b>	
(1)	[F04-OS1.3]
	[F04-OP1.3]
<b>9.10.8.7. Roofs Supporting an Occupancy</b>	
(1)	[F03-OS1.2]
	[F03-OP1.2]
<b>9.10.8.8. Floors of Exterior Passageways</b>	
(1)	[F05-OS1.5] [F06-OS1.5,OS1.2]
	[F04-OP1.3] [F06-OP1.2]

<b>9.10.9.2. Continuous Barrier</b>	
(1)	[F03-OS1.2]
	[F03-OP1.2]
(2)	[F03-OS1.2]
(3)	[F03-OS1.2]
	[F03-OP1.2]
(4)	[F03-OS1.2]
	[F04-OP1.2]
(5)	[F03-OS1.2]
	[F03-OP1.2]
<b>9.10.9.3. Openings to be Protected with Closures</b>	
(1)	[F03-OS1.2]
	[F03-OP1.2]
(2)	[F03-OS1.2]
	[F03-OP1.2]
<b>9.10.9.4. Floor Assemblies</b>	
(1)	[F03-OS1.2]
	[F03-OP1.2]
<b>9.10.9.6. General Requirements for Penetrations of Fire Separations</b>	
(1)	[F03-OS1.2]
	[F03-OP1.2]
(2)	[F03-OS1.2]
	[F03-OP1.2]
<b>9.10.9.7. Piping Penetrations</b>	
(1)	[F03-OS1.2] [F04-OS1.2]
	[F03-OP1.2] [F04-OP1.2]
(2)	[F03-OS1.2]
	[F03-OP1.2]
(5)	[F03-OS1.2] [F04-OS1.2]
	[F03-OP1.2] [F04-OP1.2]
<b>9.10.9.8. Penetrations by Outlet Boxes or Service Equipment in Concealed Spaces</b>	
(1)	[F03-OS1.2] [F04-OS1.2]
	[F03-OP1.2] [F04-OP1.2]
(6)	[F03-OS1.2] [F04-OS1.2]
	[F03-OP1.2] [F04-OP1.2]
<b>9.10.9.10. Collapse of Combustible Construction</b>	
(1)	[F03-OS1.2]

	[F03-OP1.2]
<b>9.10.9.11. Reduction in Thickness of Fire Separation by Beams and Joists</b>	
(1)	[F03-OS1.2]
	[F03-OP1.2]
<b>9.10.9.12. Concealed Spaces above Fire Separations</b>	
(1)	[F03-OS1.2]
	[F03-OP1.2]
(2)	[F03-OS1.2]
	[F03-OP1.2]
<b>9.10.9.13. Separation of Residential Occupancies</b>	
(1)	[F03-OS1.2]
	[F03-OP1.2]
(2)	[F03-OS1.2]
	[F03-OP1.2]
(3)	[F03-OS1.2]
	[F03-OP1.2]
<b>9.10.9.14. Residential Suites in Industrial Buildings</b>	
(1)	[F02-OS1.2]
<b>9.10.9.15. Separation of Suites</b>	
(1)	[F03-OS1.2]
	[F03-OP1.2]
(2)	[F02-OS1.2]
	[F02-OP1.2]
<b>9.10.9.16. Separation of Residential Suites</b>	
(1)	[F03-OS1.2]
	[F03-OP1.2]
(3)	[F03-OS1.2]
(4)	[F03-OS1.2]
	[F03-OP1.2]
<b>9.10.9.17. Separation of Public Corridors</b>	
(1)	[F05,F03-OS1.5] [F06-OS1.5,OS1.2]
	[F03,F06-OP1.2]
(2)	[F03-OS1.2] [F06,F05-OS1.5]
	[F03,F06-OP1.2]
(3)	[F03-OS1.2] [F06,F05-OS1.5]
	[F03,F06-OP1.2]
(4)	[F03-OS1.2]

	[F03-OP1.2]
(5)	[F03,F05-OS1.5] [F03,F06-OS1.5,OS1.2]
	[F03,F06-OP1.2]
<b>9.10.9.18. Separation of Storage Garages</b>	
(1)	[F03-OS1.2]
	[F03-OP1.2]
(2)	[F03-OS1.2]
	[F03-OP1.2]
(4)	[F44-OS3.4]
	[F01-OS1.1]
(5)	[F44-OS3.4]
	[F01-OS1.1]
<b>9.10.9.19. Separation of Repair Garages</b>	
(1)	[F03-OS1.2]
	[F03-OP1.2]
(3)	[F03-OS1.2]
	[F03-OP1.2]
(4)	[F44-OS3.4]
	[F44-OS1.1]
	[F44-OH1.1]
(5)	[F44-OS3.4]
	[F44-OS1.1]
	[F44-OH1.1]
<b>9.10.9.20. Exhaust Ducts Serving More Than One Fire Compartment</b>	
(1)	[F03-OS1.2]
(2)	[F03-OS1.2]
<b>9.10.9.21. Central Vacuum Systems</b>	
(1)	[F03-OS1.2]
<b>9.10.10.3. Separation of Service Rooms</b>	
(1)	[F03-OS1.2] [F03,F81-OS1.4]
	[F03-OP1.2] [F03,F81-OP1.4]
<b>9.10.10.4. Location of Fuel-Fired Appliances</b>	
(1)	[F03-OS1.2] [F03,F81-OS1.4]
	[F03-OP1.2] [F03,F81-OP1.4]
<b>9.10.10.5. Incinerators</b>	
(1)	[F03-OS1.2] [F03,F81-OS1.4]
	[F03-OP1.2] [F03,F81-OP1.4]

(2)	[F01-OS1.1]
(3)	[F01-OS1.1]
	[F40,F61-OH1.1,OH1.3]
	[F20-OP2.1] [F80-OP2.3]
	[F20-OS2.1] [F80-OS2.3]
	[F01-OP1.1]
(4)	[F01,F02-OS1.2]
<b>9.10.10.6. Storage Rooms</b>	
(1)	[F03-OS1.2]
	[F03-OP1.2]
<b>9.10.11.1. Required Firewalls</b>	
(1)	[F03-OS1.2]
	[F03-OP3.1]
	[F03-OP1.2]
<b>9.10.11.2. Firewalls Not Required</b>	
(1)	[F03-OS1.2]
	[F03-OP3.1]
(2)	[F03-OS1.2]
	[F03-OP3.1]
(3)	[F03-OS1.2]
	[F03-OP3.1]
(4)	[F03-OS1.2]
	[F03-OP3.1]
<b>9.10.12.1. Termination of Floors or Mezzanines</b>	
(1)	[F03-OS1.5]
	[F03-OP1.2,OP1.4]
<b>9.10.12.2. Location of Skylights</b>	
(1)	[F03-OS1.2]
	[F03-OP1.2]
<b>9.10.12.3. Exterior Walls Meeting at an Angle</b>	
(1)	[F03-OS1.2]
	[F03-OP1.2]
(2)	[F03-OS1.2]
	[F03-OP1.2]
(3)	[F03-OS1.2]
	[F03-OP1.2]
<b>9.10.12.4. Protection of Soffits</b>	

(2)	[F03-OS1.2]
	[F03-OP1.2]
(3)	[F03-OS1.2]
	[F03-OP1.2]
<b>9.10.13.1. Closures</b>	
(1)	[F03-OS1.2]
	[F03-OP1.2]
<b>9.10.13.2. Solid Core Wood Door as a Closure</b>	
(2)	[F03-OS1.2]
	[F03-OP1.2]
<b>9.10.13.5. Wired Glass as a Closure</b>	
(2)	[F03-OS1.2]
	[F03-OP1.2]
(3)	[F03-OS1.2]
	[F03-OP1.2]
<b>9.10.13.6. Steel Door Frames</b>	
(1)	[F03-OS1.2]
	[F03-OP1.2]
<b>9.10.13.8. Maximum Size of Opening</b>	
(1)	[F03-OS1.2]
	[F03-OP1.2]
(2)	[F03-OS1.2]
	[F03-OP1.2]
<b>9.10.13.9. Door Latch</b>	
(1)	[F03-OS1.2]
	[F03-OP1.2]
<b>9.10.13.10. Self-closing Device</b>	
(1)	[F03-OS1.2]
	[F03-OP1.2]
<b>9.10.13.12. Service Room Doors</b>	
(1)	[F30-OS3.1] Applies to portion of Code text: "Swing-type doors shall open into <i>service rooms</i> containing fuel-fired equipment where such doors lead to <i>public corridors</i> or rooms used for assembly ..."
	[F10-OS1.5] Applies to portion of Code text: "... but shall swing outward from such rooms in all other cases."
<b>9.10.13.13. Fire Dampers</b>	
(1)	[F03-OS1.2]
	[F03-OP1.2]
<b>9.10.13.14. Fire Stop Flaps</b>	

(1)	[F03-OS1.3]
	[F03-OP1.3]
<b>9.10.13.15. Doors between Garages and Dwelling Units</b>	
(1)	[F44-OS3.4]
	[F01-OS1.1]
(2)	[F44-OS3.4]
	[F01-OS1.1]
<b>9.10.13.16. Door Stops</b>	
(1)	[F81-OS1.4]
	[F81-OP1.4]
<b>9.10.14.3. Limiting Distance and Fire Department Response</b>	
(1)	[F03-OP3.1]
<b>9.10.14.4. Openings in Exposing Building Face</b>	
(1)	[F03-OP3.1]
(2)	[F03-OP3.1]
(3)	[F03-OP3.1]
(4)	[F03-OP3.1]
(6)	[F03-OP3.1]
(7)	[F03-OP3.1]
<b>9.10.14.5. Construction of Exposing Building Face and Walls above Exposing Building Face</b>	
(1)	[F02,F03-OP3.1]
(2)	[F03-OP3.1]
(3)	[F02,F03-OP3.1]
(4)	[F03-OP3.1]
(6)	[F03-OP3.1]
(7)	[F03-OP3.1]
(8)	[F02,F03-OP3.1]
(9)	[F03-OP3.1]
(10)	[F03-OP3.1]
(12)	[F03-OP3.1]
<b>9.10.15.3. Limiting Distance and Fire Department Response</b>	
(1)	[F03-OP3.1]
<b>9.10.15.4. Glazed Openings in Exposing Building Face</b>	
(1)	[F03-OP3.1]
(3)	[F03-OP3.1]
(4)	[F03-OP3.1]
(7)	[F03-OP3.1]



<b>9.10.15.5. Construction of Exposing Building Face of Houses</b>	
(2)	[F02,F03-OP3.1]
(3)	[F02,F03-OP3.1]
(5)	[F03-OP3.1]
(7)	[F02,F03-OP3.1]
(8)	[F03-OP3.1]
(9)	[F03-OP3.1]
(11)	[F03-OP3.1]
<b>9.10.16.1. Required Fire Blocks in Concealed Spaces</b>	
(1)	[F03-OS1.2]
	[F03-OP1.2]
(2)	[F03-OS1.2]
	[F03-OP1.2]
(3)	[F03-OS1.2]
	[F03-OP1.2]
(4)	[F03-OS1.2]
	[F03-OP1.2]
(5)	[F03-OS1.2]
	[F03-OP1.2]
(6)	[F02,F03-OS1.2]
	[F02,F03-OP1.2]
(7)	[F02,F03-OS1.2]
	[F02,F03-OP1.2]
<b>9.10.16.2. Required Fire Blocks in Wall Assemblies</b>	
(1)	[F03-OS1.2]
	[F03-OP1.2]
<b>9.10.16.3. Fire Block Materials</b>	
(1)	[F03-OS1.2]
	[F03-OP1.2]
(2)	[F03-OS1.2]
	[F03-OP1.2]
(3)	[F04-OS1.2]
	[F04-OP1.2]
<b>9.10.16.4. Penetration of Fire Blocks</b>	
(1)	[F03-OS1.2]
	[F03-OP1.2]
<b>9.10.17.1. Flame-Spread Rating of Interior Surfaces</b>	

(1)	[F02-OS1.2]
<b>9.10.17.2. Ceilings in Exits or Public Corridors</b>	
(1)	[F05-OS1.5]
<b>9.10.17.3. Walls in Exits</b>	
(1)	[F05-OS1.5]
(2)	[F05-OS1.5]
<b>9.10.17.4. Exterior Exit Passageways</b>	
(1)	[F05-OS1.5]
<b>9.10.17.5. Walls in Public Corridors</b>	
(1)	[F05-OS1.5]
<b>9.10.17.9. Combustible Skylights</b>	
(1)	[F02,F05-OS1.5]
<b>9.10.17.10. Protection of Foamed Plastics</b>	
(1)	[F01,F02,F05-OS1.5]
(2)	[F05-OS1.5] [F02-OS1.2]
	[F02-OP1.2]
(3)	[F01,F02-OS1.2]
<b>9.10.18.1. Access Provided through a Firewall</b>	
(1)	[F11-OS1.5]
<b>9.10.18.2. Fire Alarm System Required</b>	
(1)	[F11-OS1.5] [F13-OS1.2,OS1.5] [F03-OS1.2]
	[F13-OP1.2]
(2)	[F11-OS1.5]
<b>9.10.18.4. Rooms and Spaces Requiring Heat Detectors or Smoke Detectors</b>	
(1)	[F11-OS1.5]
(2)	[F11-OS1.5]
(3)	[F02-OS1.2] Applies to <i>sprinklered buildings</i> . [F11-OS1.5] Applies to the supervision of the system and the flow alarm.
<b>9.10.18.5. Smoke Detectors in Recirculating Air-Handling Systems</b>	
(1)	[F03-OS1.2]
<b>9.10.18.6. Portions of Buildings Considered as Separate Buildings</b>	
(1)	[F03-OS1.2]
(2)	[F11-OS1.2]
<b>9.10.18.7. Central Vacuum Systems</b>	
(1)	[F03-OS1.2]
<b>9.10.19.1. Required Smoke Alarms</b>	
(1)	[F81,F11-OS1.5]

<b>9.10.19.2. Sound Patterns of Smoke Alarms</b>	
(1)	[F11-OS1.5]
<b>9.10.19.3. Location of Smoke Alarms</b>	
(1)	[F11-OS1.5]
(2)	[F81,F11-OS1.5]
(3)	[F11-OS1.5]
<b>9.10.19.4. Power Supply</b>	
(1)	[F11,F81-OS1.5]
(3)	[F11,F81-OS1.5]
<b>9.10.19.5. Interconnection of Smoke Alarms</b>	
(1)	[F11-OS1.5]
(2)	[F11-OS1.5]
<b>9.10.19.6. Silencing of Smoke Alarms</b>	
(1)	[F11,F81-OS1.5]
<b>9.10.19.7. Instructions for Maintenance and Care</b>	
(1)	[F82-OS1.5]
<b>9.10.19.8. Residential Fire Warning Systems</b>	
(1)	[F11,F81-OS1.5]
<b>9.10.20.1. Windows or Access Panels Required</b>	
(1)	[F12-OS1.2,OS1.5]
	[F12-OP1.2]
(2)	[F12-OS1.5,OS1.2]
	[F12-OP1.2]
<b>9.10.20.2. Access to Basements</b>	
(1)	[F12-OS1.2,OS1.5]
	[F12-OP1.2]
(2)	[F12-OS1.2,OS1.5] Applies to portion of Code text: "Access required in Sentence (1) ... provides an opening not less than 1 100 mm high and 550 mm wide, the sill height of which shall not be more than 900 mm above the floor."
	[F12-OP1.2] Applies to portion of Code text: "Access required in Sentence (1) ... provides an opening not less than 1 100 mm high and 550 mm wide, the sill height of which shall not be more than 900 mm above the floor."
<b>9.10.20.3. Fire Department Access to Buildings</b>	
(1)	[F12-OS1.2,OS1.5]
	[F12-OP1.2]
(2)	[F12-OS1.2,OS1.5]
	[F12-OP1.2]
<b>9.10.20.4. Portable Extinguishers</b>	
(1)	[F81,F02,F12-OS1.2]

	[F81,F02,F12-OP1.2]
<b>9.10.20.5. Freeze Protection of Fire Protection Systems</b>	
(1)	[F81,F02-OS1.2]
	[F81,F02-OP1.2]
<b>9.10.21.2. Separation of Sleeping Rooms</b>	
(1)	[F03-OS1.2]
	[F03-OP1.2]
<b>9.10.21.3. Floor Assemblies between the First and Second Storey</b>	
(1)	[F03-OS1.2,OS1.5]
	[F03-OP1.2]
<b>9.10.21.4. Walkways Connecting Buildings</b>	
(1)	[F03,F06-OS1.2,OS1.5]
	[F03-OP1.2]
	[F03-OP3.1]
<b>9.10.21.5. Spatial Separations</b>	
(1)	[F03-OP3.1]
<b>9.10.21.6. Flame-Spread Ratings</b>	
(1)	[F05-OS1.5,OS1.2]
<b>9.10.21.7. Smoke Detectors</b>	
(1)	[F11-OS1.5]
<b>9.10.21.8. Portable Fire Extinguishers</b>	
(1)	[F81,F12,F02-OP1.2]
	[F81,F12,F02-OS1.2]
<b>9.10.21.9. Hose Stations</b>	
(1)	[F81,F12,F02-OP1.2]
	[F81,F12,F02-OS1.2]
(2)	[F12-OP1.2]
	[F12-OS1.2]
(3)	[F12-OP1.2]
	[F12-OS1.2]
<b>9.10.22.1. Installation of Cooktops and Ovens</b>	
(1)	[F81,F43,F01-OS1.1]
	[F81,F43-OS3.4]
<b>9.10.22.2. Vertical Clearances above Cooktops</b>	
(1)	[F01-OS1.1,OS1.2]
(2)	[F01-OS1.1,OS1.2]
<b>9.10.22.3. Protection around Cooktops</b>	

(1)	[F01-OS1.1,OS1.2]
(3)	[F01-OS1.1,OS1.2]
<b>9.11.1.1. Required Protection</b>	
(1)	[F56-OH3.1]
(2)	[F56-OH3.1]
(3)	[F56-OH3.1]
<b>9.11.1.2. Determination of Sound Transmission Ratings</b>	
(1)	[F56-OH3.1]
(2)	[F56-OH3.1]
<b>9.11.1.4. Adjoining Constructions</b>	
(2)	[F56-OH3.1]
(3)	[F56-OH3.1]
(4)	[F56-OH3.1]
<b>9.12.1.1. Removal of Topsoil and Organic Matter</b>	
(1)	[F40,F41,F20-OH1.1]
(2)	[F81-OS2.3]
	[F81-OP2.3,OP2.4]
	[F81-OH1.1,OH1.2,OH1.3] Applies to elements that support or are part of an environmental separator.
	[F81-OS1.2] Applies to assemblies required to provide fire resistance.
[F81-OS3.1] Applies to floors and elements that support floors.	
(3)	[F20,F21,F40,F41-OH1.1] [F20,F21-OH1.2,OH1.3] Applies to elements that support or are part of an environmental separator.
	[F20-OS2.2,OS2.3] [F21-OS2.3]
	[F20-OP2.2] [F20,F21-OP2.3,OP2.4]
	[F20,F21-OH4] Applies to floors and elements that support floors.
	[F20,F21-OS3.1] Applies to floors and elements that support floors.
<b>9.12.1.2. Standing Water</b>	
(1)	[F60-OS2.2,OS2.3]
	[F60-OP2.2,OP2.3,OP2.4]
	[F60-OH1.1,OH1.2,OH1.3] Applies to elements that support or are part of an environmental separator.
	[F60-OH4] Applies to floors and elements that support floors.
[F60-OS3.1] Applies to floors and elements that support floors.	
<b>9.12.1.3. Protection from Freezing</b>	
(1)	[F21-OS2.3]
	[F21-OP2.3,OP2.4]
	[F21-OH1.1,OH1.2,OH1.3] Applies to elements that support or are part of an environmental separator.
	[F21-OH4] Applies to floors and elements that support floors.

	[F21-OS3.1] Applies to floors and elements that support floors.
<b>9.12.2.1. Excavation to Undisturbed Soil</b>	
(1)	[F20-OS2.2,OS2.3]
	[F20-OP2.2,OP2.3,OP2.4]
	[F20-OH1.1,OH1.2,OH1.3] Applies to elements that support or are part of an environmental separator.
	[F20-OH4] Applies to floors and elements that support floors.
	[F20-OS3.1] Applies to floors and elements that support floors.
<b>9.12.2.2. Minimum Depth of Foundations</b>	
(1)	[F21-OS2.3]
	[F21-OP2.3,OP2.4]
	[F21-OH1.1,OH1.2,OH1.3] Applies to elements that support or are part of an environmental separator.
	[F21-OS3.1] Applies to floors, elements that support floors, and concrete steps with more than 2 risers.
	[F21-OH4] Applies to floors and elements that support floors.
(8)	[F21-OS2.3]
	[F21-OP2.3,OP2.4]
	[F21-OS3.1]
	[F21-OH4]
<b>9.12.3.1. Placement of Backfill</b>	
(1)	[F81-OS2.1] [F81-OS2.3] Applies to elements that support or are part of an environmental separator.
	[F81-OP2.1] [F22-OP2.4] [F81-OP2.3] Applies to elements that support or are part of an environmental separator.
	[F81-OH1.1,OH1.2,OH1.3] Applies to elements that support or are part of an environmental separator.
	[F22-OH4] Applies to floors and elements that support floors.
	[F22-OS3.1] Applies to floors and elements that support floors. [F22-OS3.7] Applies to walls, and elements that support walls, that contain doors or windows required for emergency egress.
<b>9.12.3.2. Grading of Backfill</b>	
(1)	[F60,F61-OH1.1,OH1.2,OH1.3]
	[F60,F61-OS2.3]
	[F60,F61-OP2.3]
<b>9.12.3.3. Deleterious Debris and Boulders</b>	
(1)	[F81-OS2.3]
	[F81-OP2.3]
	[F81-OH1.1,OH1.2,OH1.3]
	[F81-OS3.1] Applies to floors and elements that support floors.
(2)	[F20-OS2.1,OS2.3]
	[F20-OP2.1,OP2.3]

	[F20-OH1.1,OH1.2,OH1.3]
	[F20-OS3.1] Applies to floors and elements that support floors.
(3)	[F20-OS2.1,OS2.3]
	[F20-OP2.1,OP2.3]
	[F20-OH1.1,OH1.2,OH1.3]
	[F20-OS3.1] Applies to floors and elements that support floors.
<b>9.12.4.1. Support of Footings</b>	
(1)	[F21-OH1.1,OH1.2,OH1.3]
	[F21-OS2.1] [F21-OS2.3] Applies to elements that support or are part of an environmental separator.
	[F21-OP2.2] [F21-OP2.3] Applies to elements that support or are part of an environmental separator.
	[F21-OH2.1] Applies to sewer-line locations beneath footings.
	[F21-OS3.1] Applies to floors and elements that support floors.
<b>9.13.2.1. Required Dampproofing</b>	
(1)	[F61-OH1.1,OH1.2,OH1.3]
	[F61-OS2.3]
(2)	[F61-OH1.1,OH1.2,OH1.3]
	[F61-OS2.3]
<b>9.13.2.2. Dampproofing Materials</b>	
(1)	[F61-OH1.1,OH1.2,OH1.3]
	[F61-OS2.3]
(2)	[F61-OH1.1,OH1.2,OH1.3]
	[F61-OS2.3]
<b>9.13.2.3. Preparation of Surface</b>	
(1)	[F61-OH1.1,OH1.2,OH1.3]
	[F61-OS2.3]
(2)	[F61-OH1.1,OH1.2,OH1.3]
	[F61-OS2.3]
(3)	[F61-OH1.1,OH1.2,OH1.3]
	[F61-OS2.3]
(4)	[F61-OH1.1,OH1.2,OH1.3]
	[F61-OS2.3]
(5)	[F61-OH1.1,OH1.2,OH1.3]
	[F61-OS2.3]
(6)	[F61-OH1.1,OH1.2,OH1.3]
	[F61-OS2.3]
<b>9.13.2.4. Application of Dampproofing Material</b>	

(1)	[F61-OH1.1,OH1.2,OH1.3]
	[F61-OS2.3]
(2)	[F61-OH1.1,OH1.2,OH1.3]
	[F61-OS2.3]
(3)	[F61-OH1.1,OH1.2,OH1.3]
	[F61-OS2.3]
<b>9.13.2.5. Moisture Protection for Interior Finishes</b>	
(1)	[F61-OH1.1,OH1.2]
	[F61-OS2.3]
(2)	[F61-OH1.1,OH1.2,OH1.3]
	[F61-OS2.3]
(3)	[F61,F80-OH1.1,OH1.2,OH1.3]
	[F61,F80-OS2.3]
<b>9.13.2.6. Dampproofing of Floors-on-Ground</b>	
(1)	[F61-OH1.1,OH1.2,OH1.3]
	[F61-OS2.3]
(2)	[F61-OH1.1,OH1.2,OH1.3]
	[F61-OS2.3]
<b>9.13.3.1. Required Waterproofing</b>	
(1)	[F61-OH1.1,OH1.2,OH1.3]
	[F61-OS2.3]
(2)	[F61-OH1.1,OH1.2,OH1.3]
	[F61-OS2.3]
<b>9.13.3.2. Waterproofing Materials</b>	
(1)	[F61-OH1.1,OH1.2,OH1.3]
	[F61-OS2.3]
(2)	[F61-OH1.1,OH1.2,OH1.3]
	[F61-OS2.3]
<b>9.13.3.3. Preparation of Surface</b>	
(1)	[F61-OH1.1,OH1.2,OH1.3]
	[F61-OS2.3]
(2)	[F61-OH1.1,OH1.2,OH1.3]
	[F61-OS2.3]
(3)	[F61-OH1.1,OH1.2,OH1.3]
	[F61-OS2.3]
(4)	[F61-OH1.1,OH1.2,OH1.3]
	[F61-OS2.3]



(5)	[F61-OH1.1,OH1.2,OH1.3]
	[F61-OS2.3]
<b>9.13.3.4. Application of Waterproofing Membranes</b>	
(1)	[F61-OH1.1,OH1.2,OH1.3]
	[F61-OS2.3]
(2)	[F61-OH1.1,OH1.2,OH1.3]
	[F61-OS2.3]
(3)	[F61-OH1.1,OH1.2,OH1.3]
	[F61-OS2.3]
(4)	[F61-OH1.1,OH1.2,OH1.3]
	[F61-OS2.3]
<b>9.13.3.5. Floor Waterproofing System</b>	
(1)	[F61-OH1.1,OH1.2,OH1.3]
	[F61-OS2.3]
<b>9.13.4.2. Protection from Soil Gas Ingress</b>	
(1)	[F40-OH1.1]
(2)	[F40-OH1.1]
(3)	[F40-OH1.1]
<b>9.13.4.3. Providing for the Rough-in for a Subfloor Depressurization System</b>	
(1)	[F40-OH1.1]
(2)	[F40-OH1.1]
(3)	[F40-OH1.1]
<b>9.14.2.1. Foundation Wall Drainage</b>	
(1)	[F60-OH1.1,OH1.2,OH1.3]
	[F60-OS2.1,OS2.2,OS2.3]
	[F60-OP2.1,OP2.2,OP2.3]
(2)	(a) [F60-OH1.1,OH1.2,OH1.3] Applies where <i>foundations</i> serve as or support an environmental separator.
	(a) [F60-OS2.1] (a) [F60-OS2.3] Applies where <i>foundations</i> serve as or support an environmental separator.
	(b) [F21-OS2.1] (b) [F21-OS2.3] Applies where <i>foundations</i> serve as or support an environmental separator.
	(b) [F21-OP2.1] (b) [F21-OP2.3] Applies where <i>foundations</i> serve as or support an environmental separator. (b) [F21-OP2.4] Applies where <i>foundations</i> support walls or floors.
	(b) [F21-OH1.1,OH1.2,OH1.3] Applies where <i>foundations</i> serve as or support an environmental separator.
	(b) [F21-OH4] Applies where <i>foundations</i> support floors or elements supporting floors.

	(b) [F21-OS3.1] Applies where <i>foundations</i> support floors or elements supporting floors. (b) [F21-OS3.7] Applies where <i>foundations</i> support walls that contain windows or doors required for emergency egress.
<b>9.14.3.1. Material Standards</b>	
(1)	[F60-OH1.1,OH1.2,OH1.3]
	[F60-OS2.1,OS2.3]
	[F60-OP2.1,OP2.3]
<b>9.14.3.2. Minimum Size</b>	
(1)	[F60-OH1.1,OH1.2,OH1.3]
	[F60-OS2.1,OS2.2,OS2.3]
	[F60-OP2.1,OP2.2,OP2.3]
<b>9.14.3.3. Installation</b>	
(1)	[F60-OH1.1,OH1.2,OH1.3]
	[F60-OS2.1,OS2.2,OS2.3]
	[F60-OP2.1,OP2.2,OP2.3]
(2)	[F60-OH1.1,OH1.2,OH1.3]
	[F60-OS2.1,OS2.2,OS2.3]
	[F60-OP2.1,OP2.2,OP2.3]
(3)	[F60-OH1.1,OH1.2,OH1.3]
	[F60-OS2.1,OS2.2,OS2.3]
	[F60-OP2.1,OP2.2,OP2.3]
(4)	[F60-OH1.1,OH1.2,OH1.3]
	[F60-OS2.1,OS2.2,OS2.3]
	[F60-OP2.1,OP2.2,OP2.3]
<b>9.14.4.1. Type of Granular Material</b>	
(1)	(a) [F60-OS2.3] [F21-OS2.2]
	(a) [F60-OP2.3] [F21-OP2.6]
	(a) [F60-OH1.1,OH1.2,OH1.3]
	(b) [F21-OS2.1] (b) [F21-OS2.3] Applies to elements that support or are part of an environmental separator.
	(b) [F21-OP2.1,OP2.4] (b) [F21-OP2.3] Applies to elements that support or are part of an environmental separator.
	(b) [F21-OH1.1,OH1.2,OH1.3] Applies to elements that support or are part of an environmental separator.
	(b) [F21-OH4] Applies to floors and elements that support floors.
	(b) [F21-OS3.1] Applies to floors and elements that support floors.
<b>9.14.4.2. Installation</b>	
(1)	[F60-OH1.1,OH1.2,OH1.3]
	[F60-OS2.1,OS2.2,OS2.3]
	[F60-OP2.1,OP2.2,OP2.3]

<b>9.14.4.3. Grading</b>	
(1)	[F60-OH1.1,OH1.2,OH1.3]
	[F60-OS2.1,OS2.2,OS2.3]
	[F60-OP2.1,OP2.2,OP2.3]
<b>9.14.4.4. Wet Site Conditions</b>	
(1)	[F60-OH1.1,OH1.2,OH1.3]
	[F60-OS2.1,OS2.2,OS2.3]
	[F60-OP2.1,OP2.2,OP2.3]
<b>9.14.5.1. Drainage Disposal</b>	
(1)	[F60-OH1.1,OH1.2,OH1.3]
	[F60-OS2.1,OS2.2,OS2.3]
	[F60-OP2.1,OP2.2,OP2.3]
<b>9.14.5.2. Sump Pits</b>	
(1)	(a),(b) [F60,F61-OH1.1,OH1.3] (c) [F40-OH1.1] [F52-OH1.2]
	(a),(b) [F60,F61-OS2.1,OS2.3] (c) [F52-OS2.3]
	(a),(b) [F60,F61-OP2.3,OP2.4] (c) [F52-OP2.3]
	(c) [F30-OS3.1]
(2)	(a) [F30-OS3.1]
	(b) [F40-OH1.1]
(3)	[F60-OH1.1,OH1.2,OH1.3]
	[F60-OS2.1,OS2.2,OS2.3]
	[F60-OP2.1,OP2.2,OP2.3]
<b>9.14.5.3. Dry Wells</b>	
(1)	[F60-OH1.1,OH1.2,OH1.3]
	[F60-OS2.1,OS2.2,OS2.3]
	[F60-OP2.1,OP2.2,OP2.3]
(2)	[F60-OH1.1,OH1.2,OH1.3]
	[F60-OS2.1,OS2.2,OS2.3]
	[F60-OP2.1,OP2.2,OP2.3]
<b>9.14.6.1. Surface Drainage</b>	
(1)	[F60-OH1.1,OH1.2,OH1.3]
	[F60-OS2.1,OS2.2,OS2.3]
	[F60-OP2.1,OP2.2,OP2.3]
<b>9.14.6.2. Drainage away from Wells or Septic Disposal Beds</b>	
(1)	[F46-OH2.2] Applies to directing drainage away from the location of a water supply. [F44-OH2.1] Applies to directing drainage away from a septic tank disposal system.

<b>9.14.6.3. Window Wells</b>	
(1)	[F60-OH1.1,OH1.2,OH1.3]
	[F60-OS2.1,OS2.3]
	[F60-OP2.1,OP2.3]
<b>9.14.6.4. Catch Basin</b>	
(1)	[F61-OH1.1,OH1.2,OH1.3]
	[F61-OS2.3]
	[F61-OP2.3]
	[F61-OS3.1]
<b>9.15.1.3. Foundations for Deformation-Resistant Buildings</b>	
(1)	[F20-OS2.2] [F20,F22-OS2.3] Applies to elements that support or are part of an environmental separator.
	[F20-OP2.2] [F22-OP2.4] [F20,F22-OP2.3] Applies to elements that support or are part of an environmental separator.
	[F22-OH1.1,OH1.2,OH1.3] Applies to elements that support or are part of an environmental separator.
	[F22-OH4] Applies to floors and elements that support floors.
	[F22-OS3.1] Applies to floors and elements that support floors. [F22-OS3.7] Applies to walls, and elements that support walls, that contain doors or windows required for emergency egress.
<b>9.15.2.2. Unit Masonry Construction</b>	
(1)	[F20-OS2.1] [F20,F21,F61-OS2.3] Applies to elements that support or are part of an environmental separator.
	[F20,F21,F61-OS3.1] Applies to floors and elements that support floors.
	[F20,F21,F61-OH4] Applies to floors and elements that support floors.
	[F20,F21,F61-OH1.1,OH1.2,OH1.3] Applies to elements that support or are part of an environmental separator.
	[F20-OP2.1] [F21,F61-OP2.4] [F20,F21,F61-OP2.3] Applies to elements that support or are part of an environmental separator.
(3)	(a) [F20-OS2.1] (a) [F20,F80-OS2.3] Applies to elements that support or are part of an environmental separator.
	(a) [F20-OP2.1] (a) [F80-OP2.4] (a) [F20,F80-OP2.3] Applies to elements that support or are part of an environmental separator.
	(a) [F20,F80-OH1.1,OH1.2,OH1.3] Applies to elements that support or are part of an environmental separator.
	(a) [F20,F80-OH4] Applies to floors and elements that support floors.
	(a) [F20,F80-OS3.1] Applies to floors and elements that support floors.
	(b) [F20-OS2.1] (b) [F20,F80-OS2.3] Applies to elements that support or are part of an environmental separator.

	(b) [F20-OP2.1] (b) [F80-OP2.4] (b) [F20,F80-OP2.3] Applies to elements that support or are part of an environmental separator.
	(b) [F20,F80-OH1.1,OH1.2,OH1.3] Applies to elements that support or are part of an environmental separator.
	(b) [F20,F80-OH4] Applies to floors and elements that support floors.
	(b) [F20,F80-OS3.1] Applies to floors and elements that support floors.
	(c) [F20-OS2.1] (c) [F20,F61-OS2.3] Applies to elements that support or are part of an environmental separator.
	(c) [F20-OP2.1] (c) [F61-OP2.4] (c) [F20,F61-OP2.3] Applies to elements that support or are part of an environmental separator.
	(c) [F20,F61-OH1.1,OH1.2,OH1.3] Applies to elements that support or are part of an environmental separator.
	(c) [F20,F61-OH4] Applies to floors and elements that support floors.
	(c) [F20,F61-OS3.1] Applies to floors and elements that support floors.
<b>9.15.2.3. Pier-Type Foundations</b>	
(1)	[F20-OS2.1,OS2.2] [F20,F22-OS2.3] Applies to elements that support or are part of an environmental separator.
	[F20-OP2.1,OP2.2] [F22-OP2.4] [F20,F22-OP2.3] Applies to elements that support or are part of an environmental separator.
	[F20,F22-OH1.1,OH1.2,OH1.3] Applies to elements that support or are part of an environmental separator.
	[F20,F22-OH4] Applies to floors and elements that support floors.
	[F20,F22-OS3.1] Applies to floors and elements that support floors.
(2)	[F20-OS2.1,OS2.2] [F20,F22-OS2.3] Applies to elements that support or are part of an environmental separator.
	[F20-OP2.1,OP2.2] [F22-OP2.4] [F20,F22-OP2.3] Applies to elements that support or are part of an environmental separator.
	[F20,F22-OH1.1,OH1.2,OH1.3] Applies to elements that support or are part of an environmental separator.
	[F20,F22-OH4] Applies to floors and elements that support floors.
	[F20,F22-OS3.1] Applies to floors and elements that support floors.
(3)	[F20-OS2.1,OS2.4] [F22-OS2.4,OS2.5] [F20,F22-OS2.3] Applies to elements that support or are part of an environmental separator.
	[F20-OP2.1,OP2.4,OP2.5] [F22-OP2.4,OP2.5] [F20,F22-OP2.3] Applies to elements that support or are part of an environmental separator.
	[F20,F22-OH1.1,OH1.2,OH1.3] Applies to elements that support or are part of an environmental separator.
	[F20,F22-OH4] Applies to floors and elements that support floors.
	[F20,F22-OS3.1] Applies to floors and elements that support floors.

(4)	[F20-OS2.1,OS2.4] [F22-OS2.4,OS2.5] [F20,F22-OS2.3] Applies to elements that support or are part of an environmental separator.
	[F20-OP2.1,OP2.4] [F22-OP2.4,OP2.5] [F20,F22-OP2.3] Applies to elements that support or are part of an environmental separator.
	[F20,F22-OH1.1,OH1.2,OH1.3] Applies to elements that support or are part of an environmental separator.
	[F20,F22-OH4] Applies to floors and elements that support floors.
	[F20,F22-OS3.1] Applies to floors and elements that support floors.
<b>9.15.2.4. Wood-Frame Foundations</b>	
(1)	(a) [F20-OS2.1,OS2.2] (a) [F20,F80-OS2.3] Applies to elements that support or are part of an environmental separator.
	(a) [F20-OP2.1,OP2.2] (a) [F20,F80-OP2.3] Applies to elements that support or are part of an environmental separator.
	(a) [F20,F80-OH1.1,OH1.2,OH1.3] Applies to elements that support or are part of an environmental separator.
	(a) [F20,F80-OH4] Applies to floors and elements that support floors.
	(a) [F20,F80-OS3.1] Applies to floors and elements that support floors.
<b>9.15.3.1. Footings Required</b>	
(1)	[F20-OS2.2] [F20,F21-OS2.3] Applies to elements that support or are part of an environmental separator.
	[F20-OP2.2] [F20,F21-OP2.4] [F20,F21-OP2.3] Applies to elements that support or are part of an environmental separator.
	[F20,F21-OH1.1,OH1.2,OH1.3] Applies to elements that support or are part of an environmental separator.
	[F20,F21-OH4] Applies to floors and elements that support floors.
	[F20,F21-OS3.1] Applies to floors and elements that support floors.
<b>9.15.3.2. Support of Footings</b>	
(1)	[F21-OS2.4] [F21-OS2.3] Applies to elements that support or are part of an environmental separator.
	[F21-OP2.4] [F21-OP2.3] Applies to elements that support or are part of an environmental separator.
	[F21-OH1.1,OH1.2,OH1.3] Applies to elements that support or are part of an environmental separator.
	[F21-OH4] Applies to floors and elements that support floors.
	[F21-OS3.1] Applies to floors and elements that support floors.
(2)	[F21-OS2.1] [F21-OS2.3] Applies to elements that support or are part of an environmental separator.
	[F21-OP2.1,OP2.4] [F21-OP2.3] Applies to elements that support or are part of an environmental separator.
	[F21-OH1.1,OH1.2,OH1.3] Applies to elements that support or are part of an environmental separator.
	[F21-OH4] Applies to floors and elements that support floors.

	[F21-OS3.1] Applies to floors and elements that support floors.
<b>9.15.3.4. Basic Footing Widths and Areas</b>	
(1)	[F20-OS2.2] [F20,F21-OS2.3] Applies to elements that support or are part of an environmental separator.
	[F20-OP2.1] [F21-OP2.4] [F20,F21-OP2.3] Applies to elements that support or are part of an environmental separator.
	[F20,F21-OH1.1,OH1.2,OH1.3] Applies to elements that support or are part of an environmental separator.
	[F20,F21-OH4] Applies to floors and elements that support floors.
	[F20,F21-OS3.1] Applies to floors and elements that support floors.
(2)	[F20-OS2.2] [F20,F21-OS2.3] Applies to elements that support or are part of an environmental separator.
	[F20-OP2.2] [F21-OP2.4] [F20,F21-OP2.3] Applies to elements that support or are part of an environmental separator.
	[F20,F21-OH1.1,OH1.2,OH1.3] Applies to elements that support or are part of an environmental separator.
	[F20,F21-OH4] Applies to floors and elements that support floors.
	[F20,F21-OS3.1] Applies to floors and elements that support floors.
(3)	[F20-OS2.2] [F20,F21-OS2.3] Applies to elements that support or are part of an environmental separator.
	[F20-OP2.2] [F21-OP2.4] [F20,F21-OP2.3] Applies to elements that support or are part of an environmental separator.
	[F20,F21-OH1.1,OH1.2,OH1.3] Applies to elements that support or are part of an environmental separator.
	[F20,F21-OH4] Applies to floors and elements that support floors.
	[F20,F21-OS3.1] Applies to floors and elements that support floors.
<b>9.15.3.5. Adjustments to Footing Widths for Exterior Walls</b>	
(1)	[F20-OS2.2,OS2.3] [F21-OS2.3]
	[F20-OP2.2,OP2.3] [F21-OP2.3,OP2.4]
	[F20,F21-OH1.1,OH1.2,OH1.3]
	[F20,F21-OH4] Applies to floors and elements that support floors.
	[F20,F21-OS3.1] Applies to floors and elements that support floors.
<b>9.15.3.6. Adjustments to Footing Widths for Interior Walls</b>	
(1)	[F20-OS2.2] [F20,F21-OS2.3] Applies to elements that support or are part of an environmental separator.
	[F20-OP2.2] [F21-OP2.4] [F20,F21-OP2.3] Applies to elements that support or are part of an environmental separator.
	[F20,F21-OH1.1,OH1.2,OH1.3] Applies to elements that support or are part of an environmental separator.

	[F20,F21-OH4] Applies to floors and elements that support floors.
	[F20,F21-OS3.1] Applies to floors and elements that support floors.
(2)	[F20-OS2.2]
	[F20-OP2.2]
<b>9.15.3.7. Adjustments to Footing Area for Columns</b>	
(1)	[F20-OS2.2] [F20,F21-OS2.3] Applies to elements that support or are part of an environmental separator.
	[F20-OP2.2] [F21-OP2.4] [F20,F21-OP2.3] Applies to elements that support or are part of an environmental separator.
	[F20,F21-OH1.1,OH1.2,OH1.3] Applies to elements that support or are part of an environmental separator.
	[F20,F21-OH4] Applies to floors and elements that support floors.
	[F20,F21-OS3.1] Applies to floors and elements that support floors.
<b>9.15.3.8. Footing Thickness</b>	
(1)	[F20-OS2.1] [F20-OS2.3] Applies to elements that support or are part of an environmental separator.
	[F20-OP2.1,OP2.4] [F20-OP2.3] Applies to elements that support or are part of an environmental separator.
	[F20-OH1.1,OH1.2,OH1.3] Applies to elements that support or are part of an environmental separator.
	[F20-OH4] Applies to floors and elements that support floors.
	[F20-OS3.1] Applies to floors and elements that support floors.
<b>9.15.3.9. Step Footings</b>	
(1)	[F20,F22-OS2.3,OS2.4]
	[F20,F22-OP2.3,OP2.4]
	[F20,F22-OH1.1,OH1.2,OH1.3] Applies where the <i>foundation</i> supports or is part of an environmental separator.
	[F20,F22-OH4] Applies to <i>foundations</i> that support floors.
	[F20,F22-OS3.1] Applies to <i>foundations</i> that support floors.
<b>9.15.4.1. Flat Wall Insulating Concrete Form Units</b>	
(1)	[F22,F63,F55-OH1.1,OH1.2,OH1.3]
<b>9.15.4.2. Foundation Wall Thickness and Required Lateral Support</b>	
(1)	[F20-OS2.1,OS2.3] [F22-OS2.3]
	[F20-OP2.1,OP2.3] [F22-OP2.3,OP2.4]
	[F20,F22-OH1.1,OH1.2,OH1.3]
	[F20,F22-OH4] Applies to floors and elements that support floors.
	[F20,F22-OS3.1] Applies to floors and elements that support floors.
(2)	[F20-OS2.1,OS2.3] [F22-OS2.3]
	[F20-OP2.1,OP2.3] [F22-OP2.3,OP2.4]
	[F20,F22-OH1.1,OH1.2,OH1.3]



	[F20,F22-OH4] Applies to floors and elements that support floors.
	[F20,F22-OS3.1] Applies to floors and elements that support floors.
(3)	[F20-OS2.1,OS2.3] [F22-OS2.3]
	[F20-OP2.1,OP2.3] [F22-OP2.3,OP2.4]
	[F20,F22-OH1.1,OH1.2,OH1.3]
	[F20,F22-OH4] Applies to floors and elements that support floors.
	[F20,F22-OS3.1] Applies to floors and elements that support floors.
(4)	[F20-OS2.1,OS2.3] [F22-OS2.3,OS2.4]
	[F20-OP2.1,OP2.3] [F22-OP2.3,OP2.4]
	[F20,F22-OH1.1,OH1.2,OH1.3]
	[F20,F22-OH4] Applies to floors and elements that support floors.
	[F20,F22-OS3.1] Applies to floors and elements that support floors.
(5)	[F20-OS2.1,OS2.3] [F22-OS2.3,OS2.4]
	[F20-OP2.1,OP2.3] [F22-OP2.3,OP2.4]
	[F20,F22-OH1.1,OH1.2,OH1.3]
	[F20,F22-OH4] Applies to floors and elements that support floors.
	[F20,F22-OS3.1] Applies to floors and elements that support floors.
(6)	[F20-OS2.1,OS2.3] [F22-OS2.3,OS2.4]
	[F20-OP2.1,OP2.3] [F22-OP2.3,OP2.4]
	[F20,F22-OH1.1,OH1.2,OH1.3]
	[F20,F22-OH4] Applies to floors and elements that support floors.
	[F20,F22-OS3.1] Applies to floors and elements that support floors.
(7)	[F20-OS2.1,OS2.3] [F22-OS2.3,OS2.4]
	[F20-OP2.1,OP2.3] [F22-OP2.3,OP2.4]
	[F20,F22-OH1.1,OH1.2,OH1.3]
	[F20,F22-OH4] Applies to floors and elements that support floors.
	[F20,F22-OS3.1] Applies to floors and elements that support floors.
<b>9.15.4.5. Reinforcement for Flat Insulating Concrete Form Foundation Walls</b>	
(1)	[F20-OS2.1,OS2.3] [F22-OS2.3,OS2.4]
	[F20-OP2.1,OP2.3] [F22-OP2.3,OP2.4]
	[F20,F22-OH1.1,OH1.2,OH1.3]
	[F20,F22-OH4] Applies to floors and elements that support floors.
	[F20,F22-OS3.1] Applies to floors and elements that support floors.
(2)	[F20-OS2.1,OS2.3] [F22-OS2.3,OS2.4]
	[F20-OP2.1,OP2.3] [F22-OP2.3,OP2.4]
	[F20,F22-OH1.1,OH1.2,OH1.3]
	[F20,F22-OH4] Applies to floors and elements that support floors.

	[F20,F22-OS3.1] Applies to floors and elements that support floors.
(3)	[F20-OS2.1,OS2.3] [F22-OS2.3,OS2.4]
	[F20-OP2.1,OP2.3] [F22-OP2.3,OP2.4]
	[F20,F22-OH1.1,OH1.2,OH1.3]
	[F20,F22-OH4] Applies to floors and elements that support floors.
	[F20,F22-OS3.1] Applies to floors and elements that support floors.
(4)	[F20-OS2.1,OS2.3] [F22-OS2.3,OS2.4]
	[F20-OP2.1,OP2.3] [F22-OP2.3,OP2.4]
	[F20,F22-OH1.1,OH1.2,OH1.3]
	[F20,F22-OH4] Applies to floors and elements that support floors.
	[F20,F22-OS3.1] Applies to floors and elements that support floors.
<b>9.15.4.6. Extension above Ground Level</b>	
(1)	[F61-OH1.1,OH1.2,OH1.3]
	[F61-OS2.3]
	[F61-OP2.3]
<b>9.15.4.7. Reduction in Thickness</b>	
(1)	[F20-OS2.1] [F20-OS2.3] Applies to elements that support or are part of an environmental separator.
	[F20-OP2.1,OP2.4] [F20-OP2.3] Applies to elements that support or are part of an environmental separator.
	[F20-OH1.1,OH1.2,OH1.3] Applies to elements that support or are part of an environmental separator.
	[F20-OH4] Applies to floors and elements that support floors.
	[F20-OS3.1] Applies to floors and elements that support floors.
(2)	[F20-OH1.1,OH1.2,OH1.3] Applies to elements that support or are part of an environmental separator.
	[F20-OS2.1] [F20-OS2.3] Applies to elements that support or are part of an environmental separator.
	[F20-OP2.1,OP2.4] [F20-OP2.3] Applies to elements that support or are part of an environmental separator.
	[F20-OH4] Applies to floors and elements that support floors.
	[F20-OS3.1] Applies to floors and elements that support floors.
(3)	[F20-OS2.1] [F20-OS2.3] Applies to elements that support or are part of an environmental separator.
	[F20-OP2.1,OP2.4] [F20-OP2.3] Applies to elements that support or are part of an environmental separator.
	[F20-OH1.1,OH1.2,OH1.3] Applies to elements that support or are part of an environmental separator.
	[F20-OH4] Applies to floors and elements that support floors.
	[F20-OS3.1] Applies to floors and elements that support floors.
<b>9.15.4.9. Crack Control Joints</b>	
(1)	[F21-OS2.3]

	[F21-OP2.3]
	[F21-OH1.1,OH1.2,OH1.3] Applies to elements that support or are part of an environmental separator.
(2)	[F61-OH1.1,OH1.2,OH1.3] Applies to elements that support or are part of an environmental separator.
	[F20-OS2.1] [F20,F61-OS2.3] Applies to elements that support or are part of an environmental separator.
	[F20-OP2.1] [F20,F61-OP2.3] Applies to elements that support or are part of an environmental separator.
<b>9.15.5.1. Support of Floor Joists</b>	
(1)	[F20-OS2.1] [F40,F61-OS2.3] Applies to elements that support or are part of an environmental separator.
	[F20-OP2.1,OP2.4] [F20-OP2.3] [F40,F61-OP2.3,OP2.4] Applies to elements that support or are part of an environmental separator.
	[F20,F40,F61-OH1.1,OH1.2,OH1.3] Applies to elements that support or are part of an environmental separator.
	[F20,F40,F61-OH4] Applies to floors and elements that support floors.
	[F20,F40,F61-OS3.1] Applies to floors and elements that support floors.
<b>9.15.5.2. Support of Beams</b>	
(1)	[F20-OS2.1] [F20-OS2.3] Applies to elements that support or are part of an environmental separator.
	[F20-OP2.1,OP2.4] [F20-OP2.3] Applies to elements that support or are part of an environmental separator.
	[F20-OH1.1,OH1.2,OH1.3] Applies to elements that support or are part of an environmental separator.
	[F20-OH4] Applies to floors and elements that support floors.
	[F20-OS3.1] Applies to floors and elements that support floors.
(2)	[F80-OS2.3] Applies to elements that support or are part of an environmental separator.
	[F80-OP2.3,OP2.4] Applies to elements that support or are part of an environmental separator.
	[F80-OH1.1,OH1.2,OH1.3] Applies to elements that support or are part of an environmental separator.
	[F80-OH4] Applies to floors and elements that support floors.
	[F80-OS3.1] Applies to floors and elements that support floors.
<b>9.15.5.3. Pilasters</b>	
(1)	[F20-OS2.1] [F20-OS2.3] Applies to elements that support or are part of an environmental separator.
	[F20-OP2.1,OP2.4] [F20-OP2.3] Applies to elements that support or are part of an environmental separator.
	[F20-OH1.1,OH1.2,OH1.3] Applies to elements that support or are part of an environmental separator.
	[F20-OH4] Applies to floors and elements that support floors.
	[F20-OS3.1] Applies to floors and elements that support floors.
(2)	[F20-OH1.1,OH1.2,OH1.3] Applies to elements that support or are part of an environmental separator.
	[F20-OS2.1] [F20-OS2.3] Applies to elements that support or are part of an environmental separator.

	[F20-OP2.1,OP2.4] [F20-OP2.3] Applies to elements that support or are part of an environmental separator.
	[F20-OH4] Applies to floors and elements that support floors.
	[F20-OS3.1] Applies to floors and elements that support floors.
(3)	[F20-OS2.1] [F20-OS2.3] Applies to elements that support or are part of an environmental separator.
	[F20-OP2.1,OP2.4] [F20-OP2.3] Applies to elements that support or are part of an environmental separator.
	[F20-OH1.1,OH1.2,OH1.3] Applies to elements that support or are part of an environmental separator.
	[F20-OH4] Applies to floors and elements that support floors.
	[F20-OS3.1] Applies to floors and elements that support floors.
<b>9.15.6.2. Foundation Walls above Ground</b>	
(1)	[F61-OH1.1,OH1.2,OH1.3]
	[F61-OS2.3]
	[F61-OP2.3]
<b>9.15.6.3. Form Ties</b>	
(1)	[F61-OH1.1,OH1.2,OH1.3] Applies to elements that support or are part of an environmental separator.
	[F30-OS3.1]
	[F61-OS2.3] Applies to elements that support or are part of an environmental separator.
	[F61-OP2.3] Applies to elements that support or are part of an environmental separator.
<b>9.16.1.3. Required Floors-on-Ground</b>	
(1)	(a),(b) [F30-OS3.1]
	(a),(b) [F40-OH2.4]
<b>9.16.2.1. Required Installation of Granular Material</b>	
(1)	[F40,F61-OH1.1] [F60,F61-OH1.2,OH1.3]
	[F60-OS2.3]
<b>9.16.2.2. Support of Floors</b>	
(1)	[F21-OS2.1,OS2.3]
	[F21-OP2.1,OP2.3,OP2.4]
	[F21-OH1.1,OH1.2,OH1.3]
	[F21-OS3.1]
(2)	[F21-OS2.1,OS2.3]
	[F21-OP2.1,OP2.3,OP2.4]
	[F21-OH1.1,OH1.2,OH1.3]
	[F21-OS3.1]
(3)	[F22-OS3.1]
<b>9.16.3.1. Control of Water Ingress</b>	
(1)	[F60-OH1.1,OH1.2,OH1.3]

	[F60-OS2.3]
	[F60-OS3.1]
<b>9.16.3.2. Hydrostatic Pressure</b>	
(1)	[F20-OH1.1,OH1.2,OH1.3]
	[F20-OS2.1] [F61-OS2.3]
	[F20-OP2.1] [F61-OP2.3]
	[F20-OS3.1]
<b>9.16.3.3. Floor Drains</b>	
(1)	[F62-OH1.1,OH1.2,OH1.3]
	[F62-OS2.3]
	[F62-OS3.1]
<b>9.16.4.1. Surface Finish</b>	
(1)	[F40-OH2.4]
	[F30,F80-OS3.1]
	[F62-OH1.1,OH1.2,OH1.3]
(2)	[F41-OH1.1]
	[F20,F80-OS3.1]
<b>9.16.4.2. Topping Course</b>	
(1)	[F20,F80-OS3.1]
(2)	[F20,F80-OS3.1]
<b>9.16.4.3. Thickness</b>	
(1)	[F20-OS2.1,OS2.3]
	[F20-OS3.1]
	[F20-OP2.1,OP2.3]
	[F20-OH1.1,OH1.2,OH1.3]
	[F20-OH4]
<b>9.16.4.4. Bond Break</b>	
(1)	[F21-OS3.1]
<b>9.16.5.1. Wood-Frame Floors</b>	
(1)	[F20-OS2.1] [F20-OS2.3] Applies where wood-frame floors-on-ground serve as an environmental separator.
	[F20-OS3.1]
	[F20-OP2.1] [F20-OP2.3] Applies where wood-frame floors-on-ground serve as an environmental separator.
	[F20-OH1.1,OH1.2,OH1.3] Applies where wood-frame floors-on-ground serve as an environmental separator.
	[F20-OH4]
<b>9.17.2.1. Location</b>	

(1)	[F20-OS2.2] [F20-OS2.3] Applies to elements that support or are part of an environmental separator.
	[F20-OP2.2,OP2.4] [F20-OP2.3] Applies to elements that support or are part of an environmental separator.
	[F20-OH1.1,OH1.2,OH1.3] Applies to elements that support or are part of an environmental separator.
	[F20-OH4] Applies to floors and elements that support floors.
	[F20-OS3.1] Applies to floors and elements that support floors.
<b>9.17.2.2. Lateral Support</b>	
(1)	[F22-OS2.4,OS2.5] [F22-OS2.3] Applies to elements that support or are part of an environmental separator.
	[F22-OP2.4,OP2.5] [F22-OP2.3] Applies to elements that support or are part of an environmental separator.
	[F22-OH1.1,OH1.2,OH1.3] Applies to elements that support or are part of an environmental separator.
	[F22-OH4] Applies to floors and elements that support floors.
	[F22-OS3.1] Applies to floors and elements that support floors. [F22-OS3.7] Applies to walls, and elements that support walls, that contain doors or windows required for emergency egress.
(2)	[F22-OS2.4,OS2.5] [F22-OS2.3] Applies to elements that support or are part of an environmental separator.
	[F22-OP2.4,OP2.5] [F22-OP2.3] Applies to elements that support or are part of an environmental separator.
	[F22-OH1.1,OH1.2,OH1.3] Applies to elements that support or are part of an environmental separator.
	[F22-OH4] Applies to floors and elements that support floors.
	[F22-OS3.1] Applies to floors and elements that support floors. [F22-OS3.7] Applies to walls, and elements that support walls, that contain doors or windows required for emergency egress.
<b>9.17.3.1. Size and Thickness</b>	
(1)	[F20-OS2.1] [F20,F22-OS2.3] Applies to elements that support or are part of an environmental separator.
	[F20-OP2.1] [F20,F22-OP2.4] [F20,F22-OP2.3] Applies to elements that support or are part of an environmental separator.
	[F20,F22-OH1.1,OH1.2,OH1.3] Applies to elements that support or are part of an environmental separator.
	[F20,F22-OH4] Applies to floors and elements that support floors.
	[F20,F22-OS3.1] Applies to floors and elements that support floors.
(2)	[F20-OS2.1] [F20,F22-OS2.3] Applies to elements that support or are part of an environmental separator.
	[F20-OP2.1] [F20,F22-OP2.4] [F20,F22-OP2.3] Applies to elements that support or are part of an environmental separator.
	[F20,F22-OH1.1,OH1.2,OH1.3] Applies to elements that support or are part of an environmental separator.
	[F20,F22-OH4] Applies to floors and elements that support floors.

	[F20,F22-OS3.1] Applies to floors and elements that support floors.
<b>9.17.3.2. End Bearing Plates</b>	
(1)	[F20-OS2.1] [F20,F22-OS2.3] Applies to elements that support or are part of an environmental separator.
	[F20-OP2.1] [F20,F22-OP2.4] [F20,F22-OP2.3] Applies to elements that support or are part of an environmental separator.
	[F20,F22-OH1.1,OH1.2,OH1.3] Applies to elements that support or are part of an environmental separator.
	[F20,F22-OH4] Applies to floors and elements that support floors.
	[F20,F22-OS3.1] Applies to floors and elements that support floors.
<b>9.17.3.3. Paint</b>	
(1)	[F80-OS3.1] Applies to floors and elements that support floors.
	[F80-OS2.3]
	[F80-OP2.3,OP2.4]
	[F80-OH1.1,OH1.2,OH1.3]
	[F80-OH4] Applies to floors and elements that support floors.
<b>9.17.3.4. Design of Steel Columns</b>	
(1)	[F20-OS2.1] [F22-OS2.4] [F20,F22-OS2.3] Applies to elements that support or are part of an environmental separator.
	[F20-OP2.1] [F22-OP2.4] [F20,F22-OP2.3] Applies to elements that support or are part of an environmental separator.
	[F20,F22-OH1.1,OH1.2,OH1.3] Applies to elements that support or are part of an environmental separator.
	[F20,F22-OH4] Applies to floors and elements that support floors.
	[F20,F22-OS3.1] Applies to floors and elements that support floors. [F20,F22-OS3.7] Applies to walls, and elements that support walls, that contain doors or windows required for emergency egress.
<b>9.17.4.1. Column Sizes</b>	
(1)	[F20-OS2.1] [F20,F22-OS2.3] Applies to elements that support or are part of an environmental separator.
	[F20-OP2.1] [F20,F22-OP2.4] [F20,F22-OP2.3] Applies to elements that support or are part of an environmental separator.
	[F20,F22-OH1.1,OH1.2,OH1.3] Applies to elements that support or are part of an environmental separator.
	[F20,F22-OH4] Applies to floors and elements that support floors.
	[F20,F22-OS3.1] Applies to floors and elements that support floors.
(2)	[F20-OS2.1] [F20,F22-OS2.3] Applies to elements that support or are part of an environmental separator.

	[F20-OP2.1] [F20,F22-OP2.4] [F20,F22-OP2.3] Applies to elements that support or are part of an environmental separator.
	[F20,F22-OH1.1,OH1.2,OH1.3] Applies to elements that support or are part of an environmental separator.
	[F20,F22-OH4] Applies to floors and elements that support floors.
	[F20,F22-OS3.1] Applies to floors and elements that support floors.
<b>9.17.4.2. Materials</b>	
(1)	[F20-OS2.1] [F20,F22-OS2.3] Applies to elements that support or are part of an environmental separator.
	[F20-OP2.1] [F20,F22-OP2.4] [F20,F22-OP2.3] Applies to elements that support or are part of an environmental separator.
	[F20,F22-OH1.1,OH1.2,OH1.3] Applies to elements that support or are part of an environmental separator.
	[F20,F22-OH4] Applies to floors and elements that support floors.
	[F20,F22-OS3.1] Applies to floors and elements that support floors.
(2)	[F20-OS2.1] [F20,F22-OS2.3] Applies to elements that support or are part of an environmental separator.
	[F20-OP2.1] [F20,F22-OP2.4] [F20,F22-OP2.3] Applies to elements that support or are part of an environmental separator.
	[F20,F22-OH1.1,OH1.2,OH1.3] Applies to elements that support or are part of an environmental separator.
	[F20,F22-OH4] Applies to floors and elements that support floors.
	[F20,F22-OS3.1] Applies to floors and elements that support floors.
<b>9.17.4.3. Columns in Contact with Concrete</b>	
(1)	[F80-OS2.3] Applies to elements that support or are part of an environmental separator.
	[F80-OP2.4] [F80-OP2.3] Applies to elements that support or are part of an environmental separator.
	[F80-OH4] Applies to floors and elements that support floors.
	[F80-OH1.1,OH1.2,OH1.3] Applies to elements that support or are part of an environmental separator.
	[F80-OS3.1] Applies to floors and elements that support floors.
<b>9.17.5.1. Materials</b>	
(1)	[F20-OS2.1] [F20,F22-OS2.3] Applies to elements that support or are part of an environmental separator.
	[F20-OP2.1] [F20,F22-OP2.4] [F20,F22-OP2.3] Applies to elements that support or are part of an environmental separator.
	[F20,F22-OH1.1,OH1.2,OH1.3] Applies to elements that support or are part of an environmental separator.
	[F20,F22-OH4] Applies to floors and elements that support floors.
	[F20,F22-OS3.1] Applies to floors and elements that support floors.



<b>9.17.5.2. Sizes</b>	
(1)	[F20-OS2.1] [F20,F22-OS2.3] Applies to elements that support or are part of an environmental separator.
	[F20-OP2.1] [F20,F22-OP2.4] [F20,F22-OP2.3] Applies to elements that support or are part of an environmental separator.
	[F20,F22-OH1.1,OH1.2,OH1.3] Applies to elements that support or are part of an environmental separator.
	[F20,F22-OH4] Applies to floors and elements that support floors.
	[F20,F22-OS3.1] Applies to floors and elements that support floors.
<b>9.17.6.2. Sizes</b>	
(1)	[F20-OS2.1] [F20,F22-OS2.3] Applies to elements that support or are part of an environmental separator.
	[F20-OP2.1] [F20,F22-OP2.4] [F20,F22-OP2.3] Applies to elements that support or are part of an environmental separator.
	[F20,F22-OH1.1,OH1.2,OH1.3] Applies to elements that support or are part of an environmental separator.
	[F20,F22-OH4] Applies to floors and elements that support floors.
	[F20,F22-OS3.1] Applies to floors and elements that support floors.
<b>9.18.2.1. Access Openings</b>	
(1)	[F82-OH1.1,OH1.2]
(2)	[F51,F63-OS2.3] Applies where crawl spaces are unheated and access is from the interior. [F42,F61-OS2.3] Applies where crawl spaces are heated or unheated and access is from the exterior.
	[F63-OS2.3] Applies where crawl spaces are unheated and access is from the interior. [F42,F61-OS2.3] Applies where crawl spaces are heated or unheated and access is from the exterior.
	[F42-OH2.4,OH2.5] Applies where crawl spaces are heated or unheated and access is from the exterior.
<b>9.18.3.1. Ventilation of Unheated Crawl Spaces</b>	
(1)	[F62-OH1.1]
	[F62-OS2.3]
(2)	[F62-OH1.1]
	[F62-OS2.3]
(3)	(a) [F62-OH1.1,OH1.2] (b) [F61,F42-OH1.1,OH1.2]
	(a),(b) [F61,F62,F42-OS2.3]
	(b) [F42-OH2.3,OH2.5]
<b>9.18.4.1. Access Way to Services</b>	
(1)	[F82-OH1.1,OH1.2]
	[F82-OH2.1]
<b>9.18.5.1. Drainage</b>	
(1)	[F60-OH1.1,OH1.2]

	[F60-OS2.3]
<b>9.18.6.1. Ground Cover in Unheated Crawl Spaces</b>	
(1)	[F61-OH1.1,OH1.2]
	[F61-OS2.3]
(2)	[F61-OH1.1,OH1.2]
	[F61-OS2.3]
<b>9.18.6.2. Ground Cover in Heated Crawl Spaces</b>	
(1)	[F40,F61-OH1.1] [F61-OH1.2]
	[F61-OS2.3]
(2)	[F40,F61-OH1.1] [F61-OH1.2]
	[F61-OS2.3]
(3)	[F40-OH1.1]
(4)	[F40,F61-OH1.1,OH1.2]
	[F61-OS2.3]
<b>9.18.7.1. Crawl Spaces as Warm Air Plenums</b>	
(1)	[F51-OH1.1,OH1.2]
	[F51-OS2.3]
(2)	[F02-OS1.2]
(3)	[F01-OS1.1]
(4)	(a),(b) [F01-OS1.1]
<b>9.19.1.1. Required Venting</b>	
(1)	[F51,F62-OH1.1,OH1.2] [F51-OH1.3] Applies to sloped roof assemblies that may be subject to ice damming.
	[F62,F51-OS2.3]
<b>9.19.1.2. Vent Requirements</b>	
(1)	[F51,F62-OH1.1,OH1.2] [F51-OH1.3] Applies to sloped roof assemblies that may be subject to ice damming.
	[F62,F51-OS2.3]
(2)	[F51,F62-OH1.1,OH1.2] [F51-OH1.3] Applies to sloped roof assemblies that may be subject to ice damming.
	[F62,F51-OS2.3]
(3)	[F51,F62-OH1.1,OH1.2] [F51-OH1.3] Applies to sloped roof assemblies that may be subject to ice damming.
	[F62,F51-OS2.3]
(4)	[F51,F62-OH1.1,OH1.2] [F51-OH1.3] Applies to sloped roof assemblies that may be subject to ice damming.
	[F62,F51-OS2.3]
(5)	[F42,F51,F61,F62-OS2.3]

	[F42-OH1.1] Applies to resistance to the entry of insects. [F51,F61,F62-OH1.1,OH1.2,OH1.3]
	[F42-OH2.5] Applies to resistance to the entry of insects.
<b>9.19.1.3. Clearances</b>	
(1)	[F62,F51-OH1.1,OH1.2,OH1.3] [F62,F51-OS2.3]
(2)	[F62,F51-OH1.1,OH1.2,OH1.3] [F62,F51-OS2.3]
(3)	[F51,F62-OH1.1,OH1.2,OH1.3] [F51,F62-OS2.3]
<b>9.19.2.1. Access</b>	
(1)	[F82-OS2.3] [F82-OH1.1,OH1.2,OH1.3]
(2)	[F82-OH1.1,OH1.2] [F82-OS2.3]
(3)	[F42-OH1.1] [F61-OH1.1,OH1.2,OH1.3] Applies where access is from the exterior. [F42-OH1.1] Applies where access is from an unheated enclosed space. [F51-OH1.2] Applies where access is from an interior heated space. [F61,F42-OS2.3] Applies where access is from the exterior or an unheated enclosed space. [F42-OH2.5] Applies where access is from the exterior or an unheated enclosed space.
<b>9.20.2.1. Masonry Unit Standards</b>	
(1)	[F20,F80-OS2.1] [F20,F80-OS2.3] Applies to elements that support or are part of an environmental separator or are exposed to moisture. [F20,F80-OP2.1,OP2.4] [F20,F80-OP2.3] Applies to elements that support or are part of an environmental separator or are exposed to moisture. [F20,F80-OH1.1,OH1.2,OH1.3] Applies to elements that support or are part of an environmental separator and to masonry used in <i>chimneys</i> and fireplaces. [F20,F80-OS3.1] Applies to floors and elements that support floors. [F20,F80-OS3.4] Applies to masonry used in <i>chimneys</i> and fireplaces. [F20,F80-OS1.2] Applies to assemblies required to provide fire resistance. [F01-OS1.1,OS1.2] Applies to masonry used in <i>chimneys</i> and fireplaces. [F20,F80-OH4] Applies to floors and elements that support floors. [F20,F80-OP1.2] Applies to assemblies required to provide fire resistance. [F01,F20,F80-OP1.2] Applies to masonry used in <i>chimneys</i> and fireplaces.
<b>9.20.2.2. Used Brick</b>	
(1)	[F20,F80-OS2.1] [F20,F80-OS2.3] Applies to elements that support or are part of an environmental separator or are exposed to moisture. [F20,F80-OP2.1,OP2.4] [F20,F80-OP2.3] Applies to elements that support or are part of an environmental separator or are exposed to moisture.

	[F20,F80-OH1.1,OH1.2,OH1.3] Applies to elements that support or are part of an environmental separator and to masonry used in <i>chimneys</i> and fireplaces.
	[F20,F80-OS1.2] Applies to assemblies required to provide fire resistance. [F01-OS1.1,OS1.2] Applies to masonry used in <i>chimneys</i> and fireplaces.
	[F20,F80-OS3.1] Applies to floors and elements that support floors. [F20,F80-OS3.4] Applies to masonry used in <i>chimneys</i> and fireplaces.
	[F20,F80-OH4] Applies to floors and elements that support floors.
	[F20,F80-OP1.2] Applies to assemblies required to provide fire resistance. [F01-OP1.2] Applies to masonry used in <i>chimneys</i> and fireplaces.
<b>9.20.2.3. Glass Blocks</b>	
(1)	[F20-OS2.1] [F20-OS2.3] Applies to elements that support or are part of an environmental separator or are exposed to moisture.
	[F20-OP2.1,OP2.4] [F20-OP2.3] Applies to elements that support or are part of an environmental separator or are exposed to moisture.
	[F20-OH1.1,OH1.2,OH1.3] Applies to elements that support or are part of an environmental separator and to masonry used in <i>chimneys</i> and fireplaces.
	[F20-OH4] Applies to floors and elements that support floors.
	[F20-OS3.1] Applies to floors and elements that support floors. [F01,F20-OS3.4] Applies to masonry used in <i>chimneys</i> and fireplaces.
	[F01,F20-OS1.1] [F20-OS1.2] Applies to assemblies required to provide fire resistance.
	[F01,F20-OP1.1] [F20-OP1.2] Applies to assemblies required to provide fire resistance.
<b>9.20.2.4. Cellular Concrete</b>	
(1)	[F80-OS2.1] [F80-OS2.3] Applies to elements that support or are part of an environmental separator or are exposed to moisture.
	[F80-OP2.1,OP2.4] [F80-OP2.3] Applies to elements that support or are part of an environmental separator or are exposed to moisture.
	[F80-OH1.1,OH1.2,OH1.3] Applies to elements that support or are part of an environmental separator and to masonry used in <i>chimneys</i> and fireplaces.
	[F80-OH4] Applies to floors and elements that support floors.
	[F80-OS3.1] Applies to floors and elements that support floors. [F80-OS3.4] Applies to masonry used in <i>chimneys</i> and fireplaces.
	[F80-OP1.2] Applies to masonry used in <i>chimneys</i> and fireplaces.
	[F80-OS1.2] Applies to masonry used in <i>chimneys</i> and fireplaces.
<b>9.20.2.5. Stone</b>	
(1)	[F20,F80-OS2.1] [F20,F80-OS2.3] Applies to elements that support or are part of an environmental separator or are exposed to moisture.
	[F20,F80-OP2.1,OP2.4] [F20,F80-OP2.3] Applies to elements that support or are part of an environmental separator or are exposed to moisture.

	[F20,F80-OH1.1,OH1.2,OH1.3] Applies to elements that support or are part of an environmental separator and to masonry used in <i>chimneys</i> and fireplaces.
	[F20,F80-OS1.2] Applies to assemblies required to provide fire resistance. [F01-OS1.1,OS1.2] Applies to masonry used in <i>chimneys</i> and fireplaces.
	[F20,F80-OH4] Applies to floors and elements that support floors.
	[F20,F80-OP1.2] Applies to assemblies required to provide fire resistance. [F01,F20,F80-OP1.2] Applies to masonry used in <i>chimneys</i> and fireplaces.
<b>9.20.2.6. Concrete Blocks Exposed to the Weather</b>	
(1)	[F80-OS2.1,OS2.3] [F61-OS2.3]
	[F80-OP2.1,OP2.3] [F61-OP2.3]
	[F61,F80-OH1.1,OH1.2,OH1.3]
	[F80-OH4] Applies to floors and elements that support floors.
	[F80-OS3.1] Applies to elements that support floors. [F80-OS3.4] Applies to masonry used in <i>chimneys</i> and fireplaces.
	[F80-OP1.2] Applies to concrete blocks in <i>chimneys</i> and fireplaces.
<b>9.20.2.7. Compressive Strength</b>	
(1)	[F20,F80-OS2.1] [F20,F80-OS2.3] Applies to elements that support or are part of an environmental separator or are exposed to moisture.
	[F20,F80-OP2.1,OP2.4] [F20,F80-OP2.3] Applies to elements that support or are part of an environmental separator or are exposed to moisture.
	[F20,F80-OH1.1,OH1.2,OH1.3] Applies to elements that support or are part of an environmental separator and to masonry used in <i>chimneys</i> and fireplaces.
	[F20,F80-OS1.2] Applies to assemblies required to provide fire resistance. [F01-OS1.1,OS1.2] Applies to masonry used in <i>chimneys</i> and fireplaces.
	[F20,F80-OH4] Applies to floors and elements that support floors.
	[F20,F80-OS3.1] Applies to floors and elements that support floors. [F20,F80-OS3.4] Applies to masonry used in <i>chimneys</i> and fireplaces.
	[F20,F80-OP1.2] Applies to assemblies required to provide fire resistance. [F01,F20,F80-OP1.2] Applies to masonry used in <i>chimneys</i> and fireplaces.
<b>9.20.3.1. Mortar Materials</b>	
(1)	[F20,F80-OS2.1] [F20,F80-OS2.3] Applies to elements that support or are part of an environmental separator.
	[F20,F80-OP2.1,OP2.4] [F20,F80-OP2.3] Applies to elements that support or are part of an environmental separator.
	[F20,F80-OH1.1,OH1.2,OH1.3] Applies to elements that support or are part of an environmental separator and to masonry used in <i>chimneys</i> and fireplaces.
	[F20,F80-OH4] Applies to floors and elements that support floors.
	[F20,F80-OS3.1] Applies to floors and elements that support floors.
	[F20,F80-OS1.2] Applies to assemblies required to provide fire resistance.
(2)	[F20-OS2.1] [F20-OS2.3] Applies to elements that support or are part of an environmental separator or are exposed to moisture.

	[F20-OP2.1,OP2.4] [F20-OP2.3] Applies to elements that support or are part of an environmental separator or are exposed to moisture.
	[F20-OH1.1,OH1.2,OH1.3] Applies to elements that support or are part of an environmental separator.
	[F20-OS1.2] Applies to assemblies required to provide fire resistance.
	[F20-OH4] Applies to floors and elements that support floors.
	[F20-OS3.1] Applies to floors and elements that support floors.
(3)	[F21-OS2.1] [F21-OS2.3] Applies to elements that support or are part of an environmental separator or are exposed to moisture.
	[F21-OP2.1,OP2.4] [F21-OP2.3] Applies to elements that support or are part of an environmental separator or are exposed to moisture.
	[F21-OH1.1,OH1.2,OH1.3] Applies to elements that support or are part of an environmental separator and to masonry used in <i>chimneys</i> and fireplaces.
	[F21-OS1.2] Applies to assemblies required to provide fire resistance.
	[F21-OH4] Applies to floors and elements that support floors.
	[F21-OS3.1] Applies to floors and elements that support floors.
(4)	[F21-OS2.1] [F21-OS2.3] Applies to elements that support or are part of an environmental separator or are exposed to moisture.
	[F21-OP2.1,OP2.4] [F21-OP2.3] Applies to elements that support or are part of an environmental separator or are exposed to moisture.
	[F21-OH1.1,OH1.2,OH1.3] Applies to elements that support or are part of an environmental separator and to masonry used in <i>chimneys</i> and fireplaces.
	[F21-OS1.2] Applies to assemblies required to provide fire resistance.
	[F21-OH4] Applies to floors and elements that support floors.
	[F21-OS3.1] Applies to floors and elements that support floors.
<b>9.20.3.2. Mortar and Grout Mixes</b>	
(1)	[F20,F21,F61-OS2.1] [F20,F21,F61-OS2.3] Applies to elements that support or are part of an environmental separator.
	[F20,F21,F61-OP2.1,OP2.4] [F20,F21,F61-OP2.3] Applies to elements that support or are part of an environmental separator.
	[F20,F21,F61-OH1.1,OH1.2,OH1.3] Applies to elements that support or are part of an environmental separator and to masonry used in <i>chimneys</i> and fireplaces.
	[F20,F21,F61-OH4] Applies to floors and elements that support floors.
	[F20,F21,F61-OS3.1] Applies to floors and elements that support floors.
	[F20,F21-OS1.2] Applies to assemblies required to provide fire resistance.
(2)	(a) [F21,F61,F55-OS2.1,OS2.3]
	(a) [F21,F61,F55-OP2.1,OP2.3]
	(a) [F21,F61,F55-OH1.1,OH1.2,OH1.3]
	(b) [F21-OS2.1]

	(b) [F21-OP2.1]
	(b) [F21,F44-OS1.2] Applies to assemblies required to provide fire resistance.
(3)	[F20,F21,F61-OS2.1] [F20,F21,F61-OS2.3] Applies to elements that support or are part of an environmental separator.
	[F20,F21,F61-OP2.1,OP2.4] [F20,F21,F61-OP2.3] Applies to elements that support or are part of an environmental separator.
	[F20,F21,F61-OH1.1,OH1.2,OH1.3] Applies to elements that support or are part of an environmental separator and to masonry used in <i>chimneys</i> and fireplaces.
	[F20,F21,F61-OH4] Applies to floors and elements that support floors.
	[F20,F21,F61-OS3.1] Applies to floors and elements that support floors.
	[F20,F21-OS1.2] Applies to assemblies required to provide fire resistance.
(4)	[F20,F21-OS2.1] [F20,F21-OS2.3] Applies to elements that support or are part of an environmental separator.
	[F20,F21-OP2.1,OP2.4] [F20,F21-OP2.3] Applies to elements that support or are part of an environmental separator.
	[F20,F21-OH1.1,OH1.2,OH1.3] Applies to elements that support or are part of an environmental separator and to masonry used in <i>chimneys</i> and fireplaces.
	[F20,F21-OH4] Applies to floors and elements that support floors.
	[F20,F21-OS3.1] Applies to floors and elements that support floors.
	[F20,F21-OS1.2] Applies to assemblies required to provide fire resistance.
(5)	[F20-OS2.1] [F20-OS2.3] Applies to elements that support or are part of an environmental separator.
	[F20-OP2.1,OP2.4] [F20-OP2.3] Applies to elements that support or are part of an environmental separator.
	[F20-OH1.1,OH1.2,OH1.3] Applies to elements that support or are part of an environmental separator and to masonry used in <i>chimneys</i> and fireplaces.
	[F20-OH4] Applies to floors and elements that support floors.
	[F20-OS3.1] Applies to floors and elements that support floors.
	[F20-OS1.2] Applies to assemblies required to provide fire resistance.
(6)	[F20-OS2.1] [F20-OS2.3] Applies to elements that support or are part of an environmental separator.
	[F20-OP2.1,OP2.4] [F20-OP2.3] Applies to elements that support or are part of an environmental separator.
	[F20-OH1.1,OH1.2,OH1.3] Applies to elements that support or are part of an environmental separator and to masonry used in <i>chimneys</i> and fireplaces.
	[F20-OH4] Applies to floors and elements that support floors.
	[F20-OS3.1] Applies to floors and elements that support floors.
	[F20-OS1.2] Applies to assemblies required to provide fire resistance.
(7)	[F20,F21,F61-OS2.1] [F20,F21,F61-OS2.3] Applies to elements that support or are part of an environmental separator.
	[F20,F21,F61-OP2.1,OP2.4] [F20,F21,F61-OP2.3] Applies to elements that support or are part of an environmental separator.

	[F20,F21,F61-OH1.1,OH1.2,OH1.3] Applies to elements that support or are part of an environmental separator and to masonry used in <i>chimneys</i> and fireplaces.
	[F20,F21,F61-OH4] Applies to floors and elements that support floors.
	[F20,F21,F61-OS3.1] Applies to floors and elements that support floors.
	[F20,F21,F61-OS1.2] Applies to assemblies required to provide fire resistance.
<b>9.20.4.1. Thickness</b>	
(1)	[F20,F61-OH1.1,OH1.2,OH1.3] Applies to elements that support or are part of an environmental separator.
	[F20,F61-OS2.1] [F20,F61-OS2.3] Applies to elements that support or are part of an environmental separator or are exposed to moisture.
	[F20,F61-OP2.1,OP2.4] [F20,F61-OP2.3] Applies to elements that support or are part of an environmental separator or are exposed to moisture.
	[F20,F61-OS1.2] Applies to assemblies required to provide fire resistance.
	[F20,F61-OH4] Applies to floors and elements that support floors.
	[F20,F61-OS3.1] Applies to floors and elements that support floors.
(2)	[F20,F61-OH1.1,OH1.2,OH1.3] Applies to elements that support or are part of an environmental separator.
	[F20,F61-OS2.1] [F20,F61-OS2.3] Applies to elements that support or are part of an environmental separator or are exposed to moisture.
	[F20,F61-OP2.1,OP2.4] [F20,F61-OP2.3] Applies to elements that support or are part of an environmental separator or are exposed to moisture.
	[F20,F61-OS1.2] Applies to assemblies required to provide fire resistance.
	[F20,F61-OH4] Applies to floors and elements that support floors.
	[F20,F61-OS3.1] Applies to floors and elements that support floors.
<b>9.20.4.2. Masonry Units</b>	
(1)	[F20-OH1.1,OH1.2,OH1.3] Applies to elements that support or are part of an environmental separator and to masonry used in <i>chimneys</i> and fireplaces.
	[F20-OS2.1] [F20-OS2.3] Applies to elements that support or are part of an environmental separator or are exposed to moisture.
	[F20-OP2.1,OP2.4] [F20-OP2.3] Applies to elements that support or are part of an environmental separator or are exposed to moisture.
	[F20-OS1.2] Applies to assemblies required to provide fire resistance.
	[F20-OH4] Applies to floors and elements that support floors.
	[F20-OS3.1] Applies to floors and elements that support floors.
(2)	[F20-OS2.1] [F20-OS2.3] Applies to elements that support or are part of an environmental separator.
	[F20-OP2.1,OP2.4] [F20-OP2.3] Applies to elements that support or are part of an environmental separator.



	[F20-OH1.1,OH1.2,OH1.3] Applies to elements that support or are part of an environmental separator and to masonry used in <i>chimneys</i> and fireplaces.
	[F20-OH4] Applies to floors and elements that support floors.
	[F20-OS3.1] Applies to floors and elements that support floors.
	[F20-OS1.2] Applies to assemblies required to provide fire resistance.
(3)	[F20-OS2.1] [F20-OS2.3] Applies to elements that support or are part of an environmental separator or are exposed to moisture.
	[F20-OP2.1,OP2.4] [F20-OP2.3] Applies to elements that support or are part of an environmental separator or are exposed to moisture.
	[F20-OH1.1,OH1.2,OH1.3] Applies to elements that support or are part of an environmental separator and to masonry used in <i>chimneys</i> and fireplaces.
	[F20-OH4] Applies to floors and elements that support floors.
	[F20-OS3.1] Applies to floors and elements that support floors.
	[F20-OS1.2] Applies to assemblies required to provide fire resistance.
<b>9.20.5.1. Masonry Support</b>	
(1)	[F20,F21-OH1.1,OH1.2,OH1.3] Applies to elements that support or are part of an environmental separator.
	[F20,F21-OS2.1] [F20,F21-OS2.3] Applies to elements that support or are part of an environmental separator or are exposed to moisture.
	[F20,F21-OP2.1,OP2.4] [F20,F21-OP2.3] Applies to elements that support or are part of an environmental separator or are exposed to moisture.
	[F20,F21-OS1.2] Applies to assemblies required to provide fire resistance.
	[F20,F21-OH4] Applies to floors and elements that support floors.
	[F20,F21-OS3.1] Applies to floors and elements that support floors.
(2)	[F20-OH1.1,OH1.2,OH1.3] Applies to elements that support or are part of an environmental separator.
	[F20-OS2.1] [F20-OS2.3] Applies to elements that support or are part of an environmental separator or are exposed to moisture.
	[F20-OP2.1,OP2.4] [F20-OP2.3] Applies to elements that support or are part of an environmental separator or are exposed to moisture.
	[F20-OS1.2] Applies to assemblies required to provide fire resistance.
	[F20-OH4] Applies to floors and elements that support floors.
	[F20-OS3.1] Applies to floors and elements that support floors.
<b>9.20.5.2. Lintels or Arches</b>	
(1)	[F20,F22-OH1.1,OH1.2,OH1.3] Applies to elements that support or are part of an environmental separator.
	[F20,F22-OS2.1] [F20,F22-OS2.3] Applies to elements that support or are part of an environmental separator or are exposed to moisture.

	[F20,F22-OP2.1,OP2.4] [F20,F22-OP2.3] Applies to elements that support or are part of an environmental separator or are exposed to moisture.
	[F20,F22-OS1.2] Applies to assemblies required to provide fire resistance.
	[F20,F22-OH4] Applies to floors and elements that support floors.
	[F20,F22-OS3.1] Applies to floors and elements that support floors.
(2)	[F20,F22-OH1.1,OH1.2,OH1.3] Applies to elements that support or are part of an environmental separator.
	[F20,F22-OS2.1] [F20,F22-OS2.3] Applies to elements that support or are part of an environmental separator.
	[F20,F22-OP2.1,OP2.4] [F20,F22-OP2.3] Applies to elements that support or are part of an environmental separator or are exposed to moisture.
	[F20,F22-OS1.2] Applies to assemblies required to provide fire resistance.
(4)	[F80-OS2.1] [F80-OS2.3] Applies to elements that support or are part of an environmental separator or are exposed to moisture.
	[F80-OP2.1,OP2.4] [F80-OP2.3] Applies to elements that support or are part of an environmental separator or are exposed to moisture.
	[F80-OH1.1,OH1.2,OH1.3] Applies to elements that support or are part of an environmental separator.
	[F80-OS1.2] Applies to assemblies required to provide fire resistance.
	[F80-OH4] Applies to floors and elements that support floors.
	[F80-OS3.1] Applies to floors and elements that support floors. [F80-OS3.7] Applies to walls, and elements that support walls, that contain doors or windows required for emergency egress.
<b>9.20.6.1. Thickness of Exterior Walls</b>	
(1)	[F20,F22-OH1.1,OH1.2,OH1.3] Applies to elements that support or are part of an environmental separator.
	[F20-OS2.1,OS2.5] [F22-OS2.5] [F20,F22-OS2.3] Applies to elements that support or are part of an environmental separator.
	[F20-OP2.1,OP2.4,OP2.5] [F22-OP2.4,OP2.5] [F20,F22-OP2.3] Applies to elements that support or are part of an environmental separator.
	[F20,F22-OH4] Applies to floors and elements that support floors.
	[F20,F22-OS3.1] Applies to floors and elements that support floors.
(2)	[F20,F22-OH1.1,OH1.2,OH1.3] Applies to elements that support or are part of an environmental separator.
	[F20-OS2.1,OS2.5] [F22-OS2.5] [F20,F22-OS2.3] Applies to elements that support or are part of an environmental separator.
	[F20-OP2.1,OP2.4,OP2.5] [F22-OP2.4,OP2.5] [F20,F22-OP2.3] Applies to elements that support or are part of an environmental separator.
	[F20,F22-OH4] Applies to floors and elements that support floors.

	[F20,F22-OS3.1] Applies to floors and elements that support floors.
(3)	[F20,F22-OH1.1,OH1.2,OH1.3] Applies to elements that support or are part of an environmental separator.
	[F20-OS2.1,OS2.5] [F22-OS2.5] [F20,F22-OS2.3] Applies to elements that support or are part of an environmental separator.
	[F20-OP2.1,OP2.4,OP2.5] [F22-OP2.4,OP2.5] [F20,F22-OP2.3] Applies to elements that support or are part of an environmental separator.
	[F20,F22-OS1.2] Applies to assemblies required to provide fire resistance.
	[F20,F22-OH4] Applies to floors and elements that support floors.
	[F20,F22-OS3.1] Applies to floors and elements that support floors.
<b>9.20.6.2. Cavity Walls</b>	
(1)	[F20,F22-OH1.1,OH1.2,OH1.3] Applies to elements that support or are part of an environmental separator.
	[F20-OS2.1,OS2.5] [F22-OS2.5] [F20,F22-OS2.3] Applies to elements that support or are part of an environmental separator or are exposed to moisture.
	[F20-OP2.1,OP2.4,OP2.5] [F22-OP2.4,OP2.5] [F20,F22-OP2.3] Applies to elements that support or are part of an environmental separator or are exposed to moisture.
	[F20,F22-OS1.2] Applies to assemblies required to provide fire resistance.
	[F20,F22-OH4] Applies to floors and elements that support floors.
	[F20,F22-OS3.1] Applies to floors and elements that support floors.
(2)	[F20,F22,F61-OH1.1,OH1.2,OH1.3] Applies to elements that support or are part of an environmental separator.
	[F20-OS2.1,OS2.5] [F22-OS2.5] [F20,F22,F61-OS2.3] Applies to elements that support or are part of an environmental separator.
	[F20-OP2.1,OP2.4,OP2.5] [F22-OP2.4,OP2.5] [F20,F22,F61-OP2.3] Applies to elements that support or are part of an environmental separator.
	[F20,F22-OH4] Applies to floors and elements that support floors.
	[F20,F22-OS3.1] Applies to floors and elements that support floors.
	[F61-OS1.2] Applies to assemblies required to provide fire resistance.
(3)	[F20,F22-OH1.1,OH1.2,OH1.3] Applies to elements that support or are part of an environmental separator.
	[F20-OS2.1,OS2.5] [F22-OS2.5] [F20,F22-OS2.3] Applies to elements that support or are part of an environmental separator or are exposed to moisture.
	[F20-OP2.1,OP2.4,OP2.5] [F22-OP2.4,OP2.5] [F20,F22-OP2.3] Applies to elements that support or are part of an environmental separator.

	[F20,F22-OH4] Applies to floors and elements that support floors.
	[F20,F22-OS3.1] Applies to floors and elements that support floors.
<b>9.20.6.3. Thickness of Interior Walls</b>	
(2)	(b) [F20-OS2.1,OS2.3,OS2.5] [F22-OS2.5]
	(b) [F20-OP2.1,OP2.3,OP2.5] [F22-OP2.5]
<b>9.20.6.4. Masonry Veneer</b>	
(1)	[F20-OS2.1,OS2.5] [F22-OS2.5] [F20,F22-OS2.3] Applies to elements that are part of an environmental separator.
	[F20-OP2.1,OP2.5] [F22-OP2.5] [F20,F22-OP2.3] Applies to elements that are part of an environmental separator.
	[F20,F22-OH1.1,OH1.2,OH1.3] Applies to elements that are part of an environmental separator.
	[F20,F22-OS1.2] Applies to assemblies required to provide fire resistance.
(2)	[F61-OS2.3]
	[F61-OH1.1,OH1.2,OH1.3]
	[F61-OP2.3]
	[F61-OS1.2] Applies to assemblies required to provide fire resistance.
(3)	[F20-OS2.1,OS2.3,OS2.5] [F22-OS2.3,OS2.5]
	[F20-OP2.1,OP2.3,OP2.5] [F22-OP2.3,OP2.5]
	[F20,F22-OH1.1,OH1.2,OH1.3]
	[F20,F22-OS1.2] Applies to assemblies required to provide fire resistance.
<b>9.20.6.5. Parapet Walls</b>	
(1)	[F20-OS2.1,OS2.3,OS2.5] [F22-OS2.5]
	[F20-OP2.1,OP2.3,OP2.5] [F22-OP2.5]
	[F20,F22-OH1.1,OH1.2,OH1.3]
(2)	[F61-OS2.3]
	[F61-OP2.3]
	[F61-OH1.1,OH1.2,OH1.3]
	[F61-OS1.2]
<b>9.20.7.1. Maximum Dimensions</b>	
(1)	[F20-OS2.1,OS2.5] [F22-OS2.5] [F20,F22-OS2.3] Applies to elements that support or are part of an environmental separator.
	[F20-OP2.1,OP2.4,OP2.5] [F22-OP2.4,OP2.5] [F20,F22-OP2.3] Applies to elements that support or are part of an environmental separator.
	[F20,F22-OH1.1,OH1.2,OH1.3] Applies to elements that support or are part of an environmental separator.
	[F20,F22-OS1.2] Applies to assemblies required to provide fire resistance.
	[F20,F22-OH4] Applies to floors and elements that support floors.

	[F20,F22-OS3.1] Applies to floors and elements that support floors.
<b>9.20.7.2. Minimum Wall Thickness</b>	
(1)	[F20-OS2.1,OS2.5] [F22-OS2.5] [F20,F22-OS2.3] Applies to elements that support or are part of an environmental separator.
	[F20-OP2.1,OP2.4,OP2.5] [F22-OP2.4,OP2.5] [F20,F22-OP2.3] Applies to elements that support or are part of an environmental separator.
	[F20,F22-OH1.1,OH1.2,OH1.3] Applies to elements that support or are part of an environmental separator.
	[F20,F22-OS1.2] Applies to assemblies required to provide fire resistance.
	[F20,F22-OH4] Applies to floors and elements that support floors.
	[F20,F22-OS3.1] Applies to floors and elements that support floors.
(2)	[F20-OS2.1,OS2.5] [F22-OS2.5] [F20,F22-OS2.3] Applies to elements that support or are part of an environmental separator.
	[F20-OP2.1,OP2.4,OP2.5] [F22-OP2.4,OP2.5] [F20,F22-OP2.3] Applies to elements that support or are part of an environmental separator.
	[F20,F22-OH1.1,OH1.2,OH1.3] Applies to elements that support or are part of an environmental separator.
	[F20,F22-OS1.2] Applies to assemblies required to provide fire resistance.
	[F20,F22-OH4] Applies to floors and elements that support floors.
	[F20,F22-OS3.1] Applies to floors and elements that support floors.
<b>9.20.7.3. Separation of Chases or Recesses</b>	
(1)	[F20-OS2.1,OS2.5] [F22-OS2.5] [F20,F22-OS2.3] Applies to elements that support or are part of an environmental separator.
	[F20-OP2.1,OP2.4,OP2.5] [F22-OP2.4,OP2.5] [F20,F22-OP2.3] Applies to elements that support or are part of an environmental separator.
	[F20,F22-OH1.1,OH1.2,OH1.3] Applies to elements that support or are part of an environmental separator.
	[F20,F22-OS1.2] Applies to assemblies required to provide fire resistance.
	[F20,F22-OH4] Applies to floors and elements that support floors.
	[F20,F22-OS3.1] Applies to floors and elements that support floors.
<b>9.20.7.4. Non-Conforming Chases or Recesses</b>	
(1)	[F20,F22-OS1.2] Applies to assemblies required to provide fire resistance.
	[F20-OS2.1,OS2.5] [F22-OS2.5] [F20,F22-OS2.3] Applies to elements that support or are part of an environmental separator.
	[F20-OP2.1,OP2.4,OP2.5] [F22-OP2.4,OP2.5] [F20,F22-OP2.3] Applies to elements that support or are part of an environmental separator.

	[F20,F22-OH1.1,OH1.2,OH1.3] Applies to elements that support or are part of an environmental separator.
	[F20,F22-OH4] Applies to floors and elements that support floors.
	[F20,F22-OS3.1] Applies to floors and elements that support floors.
<b>9.20.7.5. Chases or Recesses Cut into Walls</b>	
(1)	[F20-OH1.1,OH1.2,OH1.3] Applies to elements that support or are part of an environmental separator.
	[F20-OS2.1] [F20-OS2.3] Applies to elements that support or are part of an environmental separator.
	[F20-OP2.1,OP2.4] [F20-OP2.3] Applies to elements that support or are part of an environmental separator.
	[F20-OS1.2] Applies to assemblies required to provide fire resistance.
	[F20-OH4] Applies to floors and elements that support floors.
	[F20-OS3.1] Applies to floors and elements that support floors.
<b>9.20.8.1. Capping of Hollow Masonry Walls</b>	
(1)	[F20-OH1.1,OH1.2,OH1.3] Applies to elements that support or are part of an environmental separator.
	[F20-OS2.1] [F20-OS2.3] Applies to elements that support or are part of an environmental separator.
	[F20-OP2.1,OP2.4] [F20-OP2.3] Applies to elements that support or are part of an environmental separator.
	[F20-OS1.2] Applies to assemblies required to provide fire resistance.
	[F20-OH4] Applies to floors and elements that support floors.
	[F20-OS3.1] Applies to floors and elements that support floors.
(2)	[F20-OH1.1,OH1.2,OH1.3] Applies to elements that support or are part of an environmental separator.
	[F20-OS2.1] [F20-OS2.3] Applies to elements that support or are part of an environmental separator.
	[F20-OP2.1,OP2.4] [F20-OP2.3] Applies to elements that support or are part of an environmental separator.
	[F20-OS1.2] Applies to assemblies required to provide fire resistance.
	[F20-OH4] Applies to floors and elements that support floors.
	[F20-OS3.1] Applies to floors and elements that support floors.
<b>9.20.8.2. Cavity Walls Supporting Framing Members</b>	
(1)	[F20-OH1.1,OH1.2,OH1.3] Applies to elements that support or are part of an environmental separator.
	[F20-OS2.1] [F20-OS2.3] Applies to elements that support or are part of an environmental separator.
	[F20-OP2.1,OP2.4] [F20-OP2.3] Applies to elements that support or are part of an environmental separator.
	[F20-OS1.2] Applies to assemblies required to provide fire resistance.
	[F20-OH4] Applies to floors and elements that support floors.
	[F20-OS3.1] Applies to floors and elements that support floors.
(2)	[F80-OS2.3]
	[F80-OP2.3]

(3)	[F20-OH1.1,OH1.2,OH1.3] Applies to elements that support or are part of an environmental separator.
	[F20-OS2.1] [F20-OS2.3] Applies to elements that support or are part of an environmental separator.
	[F20-OP2.1,OP2.4] [F20-OP2.3] Applies to elements that support or are part of an environmental separator.
	[F20-OS1.2] Applies to assemblies required to provide fire resistance.
	[F20-OH4] Applies to floors and elements that support floors.
	[F20-OS3.1] Applies to floors and elements that support floors.
<b>9.20.8.3. Bearing of Beams and Joists</b>	
(1)	[F20-OS2.1] [F20-OS2.3] Applies to elements that support or are part of an environmental separator.
	[F20-OP2.1] [F20-OP2.3] Applies to elements that support or are part of an environmental separator.
(2)	[F20-OS2.1] [F20-OS2.3] Applies to elements that support or are part of an environmental separator.
	[F20-OP2.1] [F20-OP2.3] Applies to elements that support or are part of an environmental separator.
(3)	[F20-OS2.1] [F20-OS2.3] Applies to elements that support or are part of an environmental separator.
	[F20-OP2.1] [F20-OP2.3] Applies to elements that support or are part of an environmental separator.
<b>9.20.8.4. Support of Beams and Columns</b>	
(1)	[F20-OS2.1,OS2.5] [F22-OS2.5] [F20,F22-OS2.3] Applies to elements that support or are part of an environmental separator.
	[F20-OP2.1,OP2.4,OP2.5] [F22-OP2.4,OP2.5] [F20,F22-OP2.3] Applies to elements that support or are part of an environmental separator.
	[F20,F22-OH1.1,OH1.2,OH1.3] Applies to elements that support or are part of an environmental separator.
	[F20,F22-OS1.2] Applies to assemblies required to provide fire resistance.
	[F20,F22-OH4] Applies to floors and elements that support floors.
	[F20,F22-OS3.1] Applies to floors and elements that support floors.
(2)	[F20-OH1.1,OH1.2,OH1.3] Applies to elements that support or are part of an environmental separator.
	[F20-OS2.1] [F20-OS2.3] Applies to elements that support or are part of an environmental separator.
	[F20-OP2.1,OP2.4] [F20-OP2.3] Applies to elements that support or are part of an environmental separator.
	[F20-OS1.2] Applies to assemblies required to provide fire resistance.
	[F20-OH4] Applies to floors and elements that support floors.
	[F20-OS3.1] Applies to floors and elements that support floors.
(3)	[F20,F22-OH1.1,OH1.2,OH1.3] Applies to elements that support or are part of an environmental separator.

	[F20-OS2.1,OS2.5] [F22-OS2.5] [F20,F22-OS2.3] Applies to elements that support or are part of an environmental separator.
	[F20-OP2.1,OP2.4,OP2.5] [F22-OP2.4,OP2.5] [F20,F22-OP2.3] Applies to elements that support or are part of an environmental separator.
	[F20,F22-OS1.2] Applies to assemblies required to provide fire resistance.
	[F20,F22-OH4] Applies to floors and elements that support floors.
	[F20,F22-OS3.1] Applies to floors and elements that support floors.
(4)	[F20,F22-OH1.1,OH1.2,OH1.3] Applies to elements that support or are part of an environmental separator.
	[F20-OS2.1,OS2.5] [F22-OS2.5] [F20,F22-OS2.3] Applies to elements that support or are part of an environmental separator.
	[F20-OP2.1,OP2.4,OP2.5] [F22-OP2.4,OP2.5] [F20,F22-OP2.3] Applies to elements that support or are part of an environmental separator.
	[F20,F22-OS1.2] Applies to assemblies required to provide fire resistance.
	[F20,F22-OH4] Applies to floors and elements that support floors.
	[F20,F22-OS3.1] Applies to floors and elements that support floors.
(5)	[F20,F22-OH1.1,OH1.2,OH1.3] Applies to elements that support or are part of an environmental separator.
	[F20-OS2.1,OS2.5] [F22-OS2.5] [F20,F22-OS2.3] Applies to elements that support or are part of an environmental separator.
	[F20-OP2.1,OP2.4,OP2.5] [F22-OP2.4,OP2.5] [F20,F22-OP2.3] Applies to elements that support or are part of an environmental separator.
	[F20,F22-OS1.2] Applies to assemblies required to provide fire resistance.
	[F20,F22-OH4] Applies to floors and elements that support floors.
	[F20,F22-OS3.1] Applies to floors and elements that support floors.
<b>9.20.8.5. Projection of Masonry Veneer Beyond Supporting Members</b>	
(1)	[F20,F22-OH1.1,OH1.2,OH1.3] Applies to elements that support or are part of an environmental separator.
	[F20-OS2.1,OS2.5] [F22-OS2.5] [F20,F22-OS2.3] Applies to elements that support or are part of an environmental separator.
	[F20-OP2.1,OP2.4,OP2.5] [F22-OP2.4,OP2.5] [F20,F22-OP2.3] Applies to elements that support or are part of an environmental separator.
	[F20,F22-OS1.2] Applies to assemblies required to provide fire resistance.
<b>9.20.9.1. Joints to be Offset or Reinforced</b>	
(1)	[F20-OH1.1,OH1.2,OH1.3] Applies to elements that support or are part of an environmental separator.
	[F20-OS2.1] [F20-OS2.3] Applies to elements that support or are part of an environmental separator.



	[F20-OP2.1,OP2.4] [F20-OP2.3] Applies to elements that support or are part of an environmental separator.
	[F20-OS1.2] Applies to assemblies required to provide fire resistance.
	[F20-OH4] Applies to floors and elements that support floors.
	[F20-OS3.1] Applies to floors and elements that support floors.
(2)	[F20-OH1.1,OH1.2,OH1.3] Applies to elements that support or are part of an environmental separator.
	[F20-OS2.1] [F20-OS2.3] Applies to elements that support or are part of an environmental separator.
	[F20-OP2.1,OP2.4] [F20-OP2.3] Applies to elements that support or are part of an environmental separator.
	[F20-OS1.2] Applies to assemblies required to provide fire resistance.
	[F20-OH4] Applies to floors and elements that support floors.
	[F20-OS3.1] Applies to floors and elements that support floors.
<b>9.20.9.2. Bonding or Tying of Other than Masonry Veneer</b>	
(1)	[F20-OS2.1,OS2.5] [F22-OS2.5] [F20,F22-OS2.3] Applies to elements that support or are part of an environmental separator.
	[F20-OP2.1,OP2.5] [F22-OP2.4,OP2.5] [F20,F22-OP2.3] Applies to elements that support or are part of an environmental separator.
	[F20,F22-OH1.1,OH1.2,OH1.3] Applies to elements that support or are part of an environmental separator.
	[F20,F22-OH4] Applies to floors and elements that support floors.
	[F20,F22-OS3.1] Applies to floors and elements that support floors. [F20,F22-OS3.7] Applies to walls, and elements that support walls, that contain doors or windows required for emergency egress.
	[F20,F22-OS1.2] Applies to assemblies required to provide fire resistance.
<b>9.20.9.3. Bonding</b>	
(1)	[F20-OH1.1,OH1.2,OH1.3] Applies to elements that support or are part of an environmental separator.
	[F20-OS2.1] [F20-OS2.3] Applies to elements that support or are part of an environmental separator.
	[F20-OP2.1,OP2.4] [F20-OP2.3] Applies to elements that support or are part of an environmental separator.
	[F20-OS1.2] Applies to assemblies required to provide fire resistance.
	[F20-OH4] Applies to floors and elements that support floors.
	[F20-OS3.1] Applies to floors and elements that support floors.
(2)	[F20-OH1.1,OH1.2,OH1.3] Applies to elements that support or are part of an environmental separator.
	[F20-OS2.1] [F20-OS2.3] Applies to elements that support or are part of an environmental separator.
	[F20-OP2.1,OP2.4] [F20-OP2.3] Applies to elements that support or are part of an environmental separator.
	[F20-OS1.2] Applies to assemblies required to provide fire resistance.
	[F20-OH4] Applies to floors and elements that support floors.

	[F20-OS3.1] Applies to floors and elements that support floors.
(3)	[F20-OH1.1,OH1.2,OH1.3] Applies to elements that support or are part of an environmental separator.
	[F20-OS2.1] [F20-OS2.3] Applies to elements that support or are part of an environmental separator.
	[F20-OP2.1,OP2.4] [F20-OP2.3] Applies to elements that support or are part of an environmental separator.
	[F20-OS1.2] Applies to assemblies required to provide fire resistance.
	[F20-OH4] Applies to floors and elements that support floors.
	[F20-OS3.1] Applies to floors and elements that support floors.
<b>9.20.9.4. Tying</b>	
(2)	[F20,F80-OH1.1,OH1.2,OH1.3] Applies to elements that support or are part of an environmental separator.
	[F20,F80-OS2.1] [F20,F80-OS2.3] Applies to elements that support or are part of an environmental separator.
	[F20,F80-OP2.1,OP2.4] [F20,F80-OP2.3] Applies to elements that support or are part of an environmental separator.
	[F20,F80-OS1.2] Applies to assemblies required to provide fire resistance.
	[F20,F80-OH4] Applies to floors and elements that support floors.
	[F20,F80-OS3.1] Applies to floors and elements that support floors. [F20,F80-OS3.7] Applies to walls, and elements that support walls, that contain doors or windows required for emergency egress.
(3)	[F20,F80-OH1.1,OH1.2,OH1.3] Applies to elements that support or are part of an environmental separator.
	[F20,F80-OS2.1] [F20,F80-OS2.3] Applies to elements that support or are part of an environmental separator.
	[F20,F80-OP2.1,OP2.4] [F20,F80-OP2.3] Applies to elements that support or are part of an environmental separator.
	[F20,F80-OS1.2] Applies to assemblies required to provide fire resistance.
	[F20,F80-OH4] Applies to floors and elements that support floors.
	[F20,F80-OS3.1] Applies to floors and elements that support floors. [F20,F80-OS3.7] Applies to walls, and elements that support walls, that contain doors or windows required for emergency egress.
(4)	[F20,F80-OH1.1,OH1.2,OH1.3] Applies to elements that support or are part of an environmental separator.
	[F20,F80-OS2.1] [F20,F80-OS2.3] Applies to elements that support or are part of an environmental separator.
	[F20,F80-OP2.1,OP2.4] [F20,F80-OP2.3] Applies to elements that support or are part of an environmental separator.
	[F20,F80-OS1.2] Applies to assemblies required to provide fire resistance.
	[F20,F80-OH4] Applies to floors and elements that support floors.
	[F20,F80-OS3.1] Applies to floors and elements that support floors. [F20,F80-OS3.7] Applies to walls, and elements that support walls, that contain doors or windows required for emergency egress.
(5)	[F20-OH1.1,OH1.2,OH1.3] Applies to elements that support or are part of an environmental separator.

	[F20-OS2.1] [F20-OS2.3] Applies to elements that support or are part of an environmental separator.
	[F20-OP2.1,OP2.4] [F20-OP2.3] Applies to elements that support or are part of an environmental separator.
	[F20-OS1.2] Applies to assemblies required to provide fire resistance.
	[F20-OH4] Applies to floors and elements that support floors.
	[F20-OS3.1] Applies to floors and elements that support floors.
(6)	[F20-OH1.1,OH1.2,OH1.3] Applies to elements that support or are part of an environmental separator.
	[F20-OS2.1] [F20-OS2.3] Applies to elements that support or are part of an environmental separator.
	[F20-OP2.1,OP2.4] [F20-OP2.3] Applies to elements that support or are part of an environmental separator.
	[F20-OS1.2] Applies to assemblies required to provide fire resistance.
	[F20-OH4] Applies to floors and elements that support floors.
	[F20-OS3.1] Applies to floors and elements that support floors.
(7)	[F20-OH1.1,OH1.2,OH1.3] Applies to elements that support or are part of an environmental separator.
	[F20-OS2.1] [F20-OS2.3] Applies to elements that support or are part of an environmental separator.
	[F20-OP2.1,OP2.4] [F20-OP2.3] Applies to elements that support or are part of an environmental separator.
	[F20-OS1.2] Applies to assemblies required to provide fire resistance.
	[F20-OH4] Applies to floors and elements that support floors.
	[F20-OS3.1] Applies to floors and elements that support floors.
(8)	[F20-OH1.1,OH1.2,OH1.3] Applies to elements that support or are part of an environmental separator.
	[F20-OS2.1] [F20-OS2.3] Applies to elements that support or are part of an environmental separator.
	[F20-OS1.2] Applies to assemblies required to provide fire resistance.
	[F20-OH4] Applies to floors and elements that support floors.
	[F20-OP2.1,OP2.4] [F20-OP2.3] Applies to elements that support or are part of an environmental separator.
	[F20-OS3.1] Applies to floors and elements that support floors.
(9)	[F20-OH1.1,OH1.2,OH1.3] Applies to elements that support or are part of an environmental separator.
	[F20-OS2.1] [F20-OS2.3] Applies to elements that support or are part of an environmental separator.
	[F20-OP2.1,OP2.4] [F20-OP2.3] Applies to elements that support or are part of an environmental separator.
	[F20-OS1.2] Applies to assemblies required to provide fire resistance.
	[F20-OH4] Applies to floors and elements that support floors.
	[F20-OS3.1] Applies to floors and elements that support floors.
<b>9.20.9.5. Ties for Masonry Veneer</b>	

(1)	[F20,F22,F80-OH1.1,OH1.2,OH1.3] Applies to elements that support or are part of an environmental separator.
	[F20,F80-OS2.1] [F20,F22,F80-OS2.5] [F20,F22,F80-OS2.3] Applies to elements that support or are part of an environmental separator.
	[F20,F80-OP2.1] [F20,F22,F80-OP2.5] [F20,F22,F80-OP2.3] Applies to elements that support or are part of an environmental separator.
	[F20,F22,F80-OS1.2] Applies to assemblies required to provide fire resistance.
(2)	[F20,F80-OS2.1] [F20,F80-OS2.3] Applies to elements that support or are part of an environmental separator.
	[F20,F80-OP2.1] [F20,F80-OP2.3] Applies to elements that support or are part of an environmental separator.
	[F20,F80-OH1.1,OH1.2,OH1.3] Applies to elements that support or are part of an environmental separator.
	[F20,F80-OS1.2] Applies to assemblies required to provide fire resistance.
<b>9.20.9.6. Reinforcing for Glass Block</b>	
(1)	[F20-OH1.1,OH1.2,OH1.3] Applies to elements that are part of an environmental separator.
	[F20-OS2.1] [F20-OS2.3] Applies to elements that are part of an environmental separator.
	[F20-OP2.1] [F20-OP2.3] Applies to elements that are part of an environmental separator.
	[F20-OS1.2] Applies to assemblies required to provide fire resistance.
(2)	[F20-OH1.1,OH1.2,OH1.3] Applies to elements that are part of an environmental separator.
	[F20-OS2.1] [F20-OS2.3] Applies to elements that are part of an environmental separator.
	[F20-OP2.1] [F20-OP2.3] Applies to elements that are part of an environmental separator.
	[F20-OS1.2] Applies to assemblies required to provide fire resistance.
<b>9.20.10.1. Lateral Support Required</b>	
(1)	[F20,F22-OH1.1,OH1.2,OH1.3] Applies to elements that support or are part of an environmental separator.
	[F20-OS2.1] [F20,F22-OS2.5] [F20,F22-OS2.3] Applies to elements that support or are part of an environmental separator.
	[F20-OP2.1] [F20,F22-OP2.4,OP2.5] [F20,F22-OP2.3] Applies to elements that support or are part of an environmental separator.
	[F20,F22-OS1.2] Applies to assemblies required to provide fire resistance.
	[F20,F22-OH4] Applies to floors and elements that support floors.
	[F20,F22-OS3.1] Applies to floors and elements that support floors.
	(2)

	[F20-OS2.1] [F20,F22-OS2.5] (a) [F20,F22-OS2.3] Applies to elements that support or are part of an environmental separator.
	[F20-OP2.1,OP2.4] [F20,F22-OP2.5] (a) [F20,F22-OP2.3] Applies to elements that support or are part of an environmental separator.
	[F20,F22-OS1.2] Applies to assemblies required to provide fire resistance.
	(a) [F20,F22-OH4] Applies to floors and elements that support floors.
	(a) [F20,F22-OS3.1] Applies to floors and elements that support floors.
(4)	[F20,F22-OH1.1,OH1.2,OH1.3] Applies to elements that support or are part of an environmental separator.
	[F20-OS2.1] [F20,F22-OS2.5] [F20,F22-OS2.3] Applies to elements that support or are part of an environmental separator or are exposed to moisture.
	[F20-OP2.1] [F20,F22-OP2.4,OP2.5] [F20,F22-OP2.3] Applies to elements that support or are part of an environmental separator or are exposed to moisture.
	[F20,F22-OS1.2] Applies to assemblies required to provide fire resistance.
	[F20,F22-OH4] Applies to floors and elements that support floors.
	[F20,F22-OS3.1] Applies to floors and elements that support floors.
<b>9.20.11.1. Anchorage to Floor or Roof Assemblies where Masonry Walls Require Lateral Support</b>	
(1)	[F20,F22-OH1.1,OH1.2,OH1.3] Applies to elements that support or are part of an environmental separator.
	[F20-OS2.1] [F20,F22-OS2.5] [F20,F22-OS2.3] Applies to elements that support or are part of an environmental separator.
	[F20-OP2.1] [F20,F22-OP2.4,OP2.5] [F20,F22-OP2.3] Applies to elements that support or are part of an environmental separator.
	[F20,F22-OS1.2] Applies to assemblies required to provide fire resistance.
	[F20,F22-OH4] Applies to floors and elements that support floors.
	[F20,F22-OS3.1] Applies to floors and elements that support floors.
(2)	[F20,F80-OH1.1,OH1.2,OH1.3] Applies to elements that support or are part of an environmental separator.
	[F20,F80-OS2.1] [F20,F80-OS2.3] Applies to elements that support or are part of an environmental separator.
	[F20,F80-OP2.1,OP2.4] [F20,F80-OP2.3] Applies to elements that support or are part of an environmental separator or are exposed to moisture.
	[F20,F80-OS1.2] Applies to assemblies required to provide fire resistance.
	[F20,F80-OH4] Applies to floors and elements that support floors.
	[F20,F80-OS3.1] Applies to floors and elements that support floors. [F20,F80-OS3.7] Applies to walls, and elements that support walls, that contain doors or windows required for emergency egress.

(3)	[F20-OH1.1,OH1.2,OH1.3] Applies to elements that support or are part of an environmental separator.
	[F20-OS2.1] [F20-OS2.3] Applies to elements that support or are part of an environmental separator.
	[F20-OP2.1,OP2.4] [F20-OP2.3] Applies to elements that support or are part of an environmental separator or are exposed to moisture.
	[F20-OS1.2] Applies to assemblies required to provide fire resistance.
	[F20-OH4] Applies to floors and elements that support floors.
	[F20-OS3.1] Applies to floors and elements that support floors.
(4)	[F20,F22-OH1.1,OH1.2,OH1.3] Applies to elements that support or are part of an environmental separator.
	[F20-OS2.1] [F20,F22-OS2.5] [F20,F22-OS2.3] Applies to elements that support or are part of an environmental separator.
	[F20-OP2.1] [F20,F22-OP2.4,OP2.5] [F20,F22-OP2.3] Applies to elements that support or are part of an environmental separator or are exposed to moisture.
	[F20,F22-OS1.2] Applies to assemblies required to provide fire resistance.
	[F20,F22-OH4] Applies to floors and elements that support floors.
	[F20,F22-OS3.1] Applies to floors and elements that support floors.
<b>9.20.11.2. Bonding and Tying Intersecting Masonry Walls where Walls Require Lateral Support</b>	
(1)	[F20,F22-OH1.1,OH1.2,OH1.3] Applies to elements that support or are part of an environmental separator.
	[F20-OS2.1] [F20,F22-OS2.5] [F20,F22-OS2.3] Applies to elements that support or are part of an environmental separator.
	[F20-OP2.1] [F20,F22-OP2.4,OP2.5] [F20,F22-OP2.3] Applies to elements that support or are part of an environmental separator or are exposed to moisture.
	[F20,F22-OS1.2] Applies to assemblies required to provide fire resistance.
	[F20,F22-OH4] Applies to floors and elements that support floors.
	[F20,F22-OS3.1] Applies to floors and elements that support floors.
(2)	[F20-OH1.1,OH1.2,OH1.3] Applies to elements that support or are part of an environmental separator.
	[F20-OS2.1] [F20-OS2.3] Applies to elements that support or are part of an environmental separator.
	[F20-OP2.1,OP2.4] [F20-OP2.3] Applies to elements that support or are part of an environmental separator.
	[F20-OS1.2] Applies to assemblies required to provide fire resistance.
	[F20-OH4] Applies to floors and elements that support floors.
	[F20-OS3.1] Applies to floors and elements that support floors.
(3)	[F20,F80-OS1.2] Applies to assemblies required to provide fire resistance.

	[F20,F80-OS2.1] [F20,F80-OS2.3] Applies to elements that support or are part of an environmental separator.
	[F20,F80-OP2.1,OP2.4] [F20,F80-OP2.3] Applies to elements that support or are part of an environmental separator.
	[F20,F80-OH1.1,OH1.2,OH1.3] Applies to elements that support or are part of an environmental separator.
	[F20,F80-OH4] Applies to floors and elements that support floors.
	[F20,F80-OS3.1] Applies to floors and elements that support floors. [F20,F80-OS3.7] Applies to walls, and elements that support walls, that contain doors or windows required for emergency egress.
<b>9.20.11.3. Anchoring Intersecting Wood-Frame Walls to Masonry Walls</b>	
(1)	[F20,F22,F80-OH1.1,OH1.2,OH1.3] Applies to elements that support or are part of an environmental separator.
	[F20,F80-OS2.1] [F20,F22,F80-OS2.5] [F20,F22,F80-OS2.3] Applies to elements that support or are part of an environmental separator.
	[F20,F80-OP2.1] [F20,F22,F80-OP2.4,OP2.5] [F20,F22,F80-OP2.3] Applies to elements that support or are part of an environmental separator.
	[F20,F22,F80-OS1.2] Applies to assemblies required to provide fire resistance.
	[F20,F22,F80-OH4] Applies to floors and elements that support floors.
	[F20,F22,F80-OS3.1] Applies to floors and elements that support floors. [F20,F22,F80-OS3.7] Applies to walls, and elements that support walls, that contain doors or windows required for emergency egress.
(2)	[F20-OH1.1,OH1.2,OH1.3] Applies to elements that support or are part of an environmental separator.
	[F20-OS2.1] [F20-OS2.3] Applies to elements that support or are part of an environmental separator.
	[F20-OP2.1,OP2.4] [F20-OP2.3] Applies to elements that support or are part of an environmental separator.
	[F20-OS1.2] Applies to assemblies required to provide fire resistance.
	[F20-OH4] Applies to floors and elements that support floors.
	[F20-OS3.1] Applies to floors and elements that support floors.
<b>9.20.11.4. Anchoring Wood-Frame Roof Systems to Masonry Walls</b>	
(1)	[F20-OH1.1,OH1.2,OH1.3]
	[F20-OS2.1,OS2.3]
	[F20-OP2.1,OP2.3]
(2)	[F20-OH1.1,OH1.2,OH1.3]
	[F20-OS2.1,OS2.3]
	[F20-OP2.1,OP2.3]
<b>9.20.11.5. Anchoring Masonry Cornices, Sills and Trim to Masonry Walls</b>	
(1)	[F20,F80-OS2.1,OS2.3,OS2.5] [F22-OS2.5]
<b>9.20.11.6. Anchoring to Masonry Piers</b>	

(1)	[F20-OS2.1] [F20-OS2.3] Applies to elements that support or are part of an environmental separator.
	[F20-OP2.1] [F20-OP2.3] Applies to elements that support or are part of an environmental separator.
	[F20-OH1.1,OH1.2,OH1.3] Applies to elements that support or are part of an environmental separator.
	[F20-OH4] Applies to floors and elements that support floors.
	[F20-OS3.1] Applies to floors and elements that support floors.
	[F20-OS1.2] Applies to assemblies required to provide fire resistance.
<b>9.20.12.1. Corbelling</b>	
(1)	[F20-OS2.1] [F20-OS2.3] Applies to elements that support or are part of an environmental separator.
	[F20-OP2.1] [F20-OP2.3] Applies to elements that support or are part of an environmental separator.
	[F20-OH1.1,OH1.2,OH1.3] Applies to elements that support or are part of an environmental separator.
	[F20-OS1.2] Applies to assemblies required to provide fire resistance.
	[F20-OH4] Applies to floors and elements that support floors.
	[F20-OS3.1] Applies to floors and elements that support floors.
(2)	[F20-OS2.1] [F20-OS2.3] Applies to elements that support or are part of an environmental separator.
	[F20-OP2.1,OP2.4] [F20-OP2.3] Applies to elements that support or are part of an environmental separator.
	[F20-OH1.1,OH1.2,OH1.3] Applies to elements that support or are part of an environmental separator.
	[F20-OS1.2] Applies to assemblies required to provide fire resistance.
	[F20-OH4] Applies to floors and elements that support floors.
	[F20-OS3.1] Applies to floors and elements that support floors.
<b>9.20.12.2. Corbelling for Cavity Walls</b>	
(1)	[F20-OH1.1,OH1.2,OH1.3] Applies to elements that support or are part of an environmental separator.
	[F20-OS2.1] [F20-OS2.3] Applies to elements that support or are part of an environmental separator.
	[F20-OP2.1,OP2.4] [F20-OP2.3] Applies to elements that support or are part of an environmental separator.
	[F20-OH4] Applies to floors and elements that support floors.
	[F20-OS3.1] Applies to floors and elements that support floors.
(2)	[F20-OH1.1,OH1.2,OH1.3] Applies to elements that support or are part of an environmental separator.
	[F20-OS2.1] [F20-OS2.3] Applies to elements that support or are part of an environmental separator.
	[F20-OP2.1,OP2.4] [F20-OP2.3] Applies to elements that support or are part of an environmental separator.
	[F20-OH4] Applies to floors and elements that support floors.
	[F20-OS3.1] Applies to floors and elements that support floors.
<b>9.20.12.3. Corbelling for Masonry Veneer</b>	



(1)	[F20-OH1.1,OH1.2,OH1.3] Applies to elements that support or are part of an environmental separator.
	[F20-OS2.1] [F20-OS2.3] Applies to elements that support or are part of an environmental separator.
	[F20-OP2.1] [F20-OP2.3] Applies to elements that support or are part of an environmental separator.
(2)	[F20-OH1.1,OH1.2,OH1.3] Applies to elements that support or are part of an environmental separator.
	[F20-OS2.1] [F20-OS2.3] Applies to elements that support or are part of an environmental separator.
	[F20-OP2.1] [F20-OP2.3] Applies to elements that support or are part of an environmental separator.
<b>9.20.13.1. Materials for Flashing</b>	
(1)	[F80-OS2.1,OS2.3]
	[F80-OP2.1,OP2.3]
	[F80-OH1.1,OH1.2,OH1.3]
	[F80-OS1.2] Applies to assemblies required to provide fire resistance.
(2)	[F80-OS2.1,OS2.3]
	[F80-OP2.1,OP2.3]
	[F80-OH1.1,OH1.2,OH1.3]
	[F80-OS1.2] Applies to assemblies required to provide fire resistance.
<b>9.20.13.2. Fastening of Flashing</b>	
(1)	[F80-OH1.1,OH1.2,OH1.3]
	[F80-OS2.1,OS2.3]
	[F80-OP2.1,OP2.3]
	[F80-OS1.2] Applies to assemblies required to provide fire resistance.
<b>9.20.13.3. Location of Flashing</b>	
(1)	[F61,F62-OS2.1,OS2.3]
	[F61,F62-OP2.1,OP2.3]
	[F61,F62-OH1.1,OH1.2,OH1.3]
<b>9.20.13.4. Extension of Flashing</b>	
(1)	[F61-OS2.1,OS2.3]
	[F61-OP2.1,OP2.3]
	[F61-OH1.1,OH1.2,OH1.3]
	[F61-OS1.2] Applies to assemblies required to provide fire resistance.
<b>9.20.13.5. Flashing for Weep Holes in Masonry/Masonry Walls</b>	
(1)	[F61,F62-OH1.1,OH1.2,OH1.3]
	[F61,F62-OS2.1,OS2.3]
	[F61,F62-OP2.1,OP2.3]
	[F61,F62-OS1.2] Applies to assemblies required to provide fire resistance.
<b>9.20.13.6. Flashing for Weep Holes in Masonry Veneer</b>	

(2)	[F61,F62-OS2.1,OS2.3]
	[F61,F62-OP2.1,OP2.3]
	[F61,F62-OH1.1,OH1.2,OH1.3]
	[F61,F62-OS1.2] Applies to assemblies required to provide fire resistance.
(3)	[F61-OH1.1,OH1.2,OH1.3]
	[F61-OS2.1,OS2.3]
	[F61-OP2.1,OP2.3]
	[F61-OS1.2] Applies to assemblies required to provide fire resistance.
<b>9.20.13.7. Flashing Joints</b>	
(1)	[F61,F62-OH1.1,OH1.2,OH1.3]
	[F61,F62-OS2.1,OS2.3]
	[F61,F62-OP2.1,OP2.3]
	[F61,F62-OS1.2] Applies to assemblies required to provide fire resistance.
<b>9.20.13.8. Required Weep Holes</b>	
(1)	[F62-OS2.1,OS2.3]
	[F62-OP2.1,OP2.3]
	[F62-OH1.1,OH1.2,OH1.3]
	[F62-OS1.2] Applies to assemblies required to provide fire resistance.
<b>9.20.13.9. Protection of Interior Finish</b>	
(1)	[F61-OH1.1,OH1.2,OH1.3]
	[F61-OS2.1,OS2.3]
	[F61-OP2.1,OP2.3]
(2)	[F61,F62-OS2.1,OS2.3]
	[F61,F62-OP2.1,OP2.3]
	[F61,F62-OH1.1,OH1.2,OH1.3]
<b>9.20.13.10. Mortar Droppings</b>	
(1)	[F61,F62-OH1.1,OH1.2,OH1.3]
	[F61,F62-OS2.1,OS2.3]
	[F61,F62-OP2.1,OP2.3]
	[F61,F62-OS1.2] Applies to assemblies required to provide fire resistance.
<b>9.20.13.12. Drips beneath Window Sills</b>	
(1)	[F61,F62-OH1.1,OH1.2,OH1.3]
	[F61,F62-OS2.1,OS2.3]
	[F61,F62-OP2.1,OP2.3]
	[F61,F62-OS1.2] Applies to assemblies required to provide fire resistance.
<b>9.20.14.1. Laying Temperature of Mortar and Masonry</b>	

(1)	[F20,F80-OS2.1] [F20,F80-OS2.3] Applies to elements that support or are part of an environmental separator or are exposed to moisture.
	[F20,F80-OP2.1,OP2.4] [F20,F80-OP2.3] Applies to elements that support or are part of an environmental separator or are exposed to moisture.
	[F20,F80-OH1.1,OH1.2,OH1.3] Applies to elements that support or are part of an environmental separator.
	[F20,F80-OS1.2] Applies to assemblies required to provide fire resistance.
	[F20,F80-OH4] Applies to floors and elements that support floors.
	[F20,F80-OS3.1] Applies to floors and elements that support floors. [F20,F80-OS3.7] Applies to walls, and elements that support walls, that contain doors or windows required for emergency egress.
(2)	[F20,F80-OS2.1] [F20,F80-OS2.3] Applies to elements that support or are part of an environmental separator or are exposed to moisture.
	[F20,F80-OP2.1,OP2.4] [F20,F80-OP2.3] Applies to elements that support or are part of an environmental separator or are exposed to moisture.
	[F20,F80-OH1.1,OH1.2,OH1.3] Applies to elements that support or are part of an environmental separator.
	[F20,F80-OS1.2] Applies to assemblies required to provide fire resistance.
	[F20,F80-OH4] Applies to floors and elements that support floors.
	[F20,F80-OS3.1] Applies to floors and elements that support floors. [F20,F80-OS3.7] Applies to walls, and elements that support walls, that contain doors or windows required for emergency egress.
<b>9.20.14.2. Protection from Weather</b>	
(1)	[F80-OS2.1,OS2.3]
	[F80-OP2.1,OP2.3]
<b>9.20.15.1. Amount of Reinforcement</b>	
(1)	[F20-OS2.1,OS2.3]
	[F20-OP2.1,OP2.3]
<b>9.20.15.2. Installation Standard</b>	
(1)	[F20-OS2.1,OS2.3]
	[F20-OP2.1,OP2.3]
<b>9.20.16.1. Corrosion Resistance of Connectors</b>	
(1)	[F80-OH1.1,OH1.2,OH1.3] Applies to elements that support or are part of an environmental separator.
	[F80-OS2.1] [F80-OS2.3] Applies to elements that support or are part of an environmental separator or are exposed to moisture.
	[F80-OP2.1,OP2.4] [F80-OP2.3] Applies to elements that support or are part of an environmental separator or are exposed to moisture.
	[F80-OS1.2] Applies to assemblies required to provide fire resistance.

	[F80-OH4] Applies to floors and elements that support floors.
	[F80-OS3.1] Applies to floors and elements that support floors. [F80-OS3.7] Applies to walls, and elements that support walls, that contain doors or windows required for emergency egress.
<b>9.20.17.1. Thickness of Flat Insulating Concrete Form Walls</b>	
(1)	[F20-OS2.1] [F22-OS2.4] [F20,F22-OS2.3] Applies to elements that support or are part of an environmental separator.
	[F20-OP2.1] [F22-OP2.4] [F20,F22-OP2.3] Applies to elements that support or are part of an environmental separator.
	[F20,F22-OH1.1,OH1.2,OH1.3] Applies to elements that support or are part of an environmental separator.
	[F20,F22-OH4] Applies to floors and elements that support floors.
	[F20,F22-OS3.1] Applies to floors and elements that support floors. [F20,F22-OS3.7] Applies to walls, and elements that support walls, that contain doors or windows required for emergency egress.
<b>9.20.17.2. Reinforcement for Flat Insulating Concrete Form Walls</b>	
(1)	[F20-OS2.1] [F22-OS2.4] [F20,F22-OS2.3] Applies to elements that support or are part of an environmental separator.
	[F20-OP2.1] [F22-OP2.4] [F20,F22-OP2.3] Applies to elements that support or are part of an environmental separator.
	[F20,F22-OH1.1,OH1.2,OH1.3] Applies to elements that support or are part of an environmental separator.
	[F20,F22-OH4] Applies to floors and elements that support floors.
	[F20,F22-OS3.1] Applies to floors and elements that support floors. [F20,F22-OS3.7] Applies to walls, and elements that support walls, that contain doors or windows required for emergency egress.
(2)	[F20-OS2.1] [F22-OS2.4] [F20,F22-OS2.3] Applies to elements that support or are part of an environmental separator.
	[F20-OP2.1] [F22-OP2.4] [F20,F22-OP2.3] Applies to elements that support or are part of an environmental separator.
	[F20,F22-OH1.1,OH1.2,OH1.3] Applies to elements that support or are part of an environmental separator.
	[F20,F22-OH4] Applies to floors and elements that support floors.
	[F20,F22-OS3.1] Applies to floors and elements that support floors. [F20,F22-OS3.7] Applies to walls, and elements that support walls, that contain doors or windows required for emergency egress.
(3)	[F20-OS2.1] [F22-OS2.4] [F20,F22-OS2.3] Applies to elements that support or are part of an environmental separator.
	[F20-OP2.1] [F22-OP2.4] [F20,F22-OP2.3] Applies to elements that support or are part of an environmental separator.

	[F20,F22-OH1.1,OH1.2,OH1.3] Applies to elements that support or are part of an environmental separator.
	[F20,F22-OH4] Applies to floors and elements that support floors.
	[F20,F22-OS3.1] Applies to floors and elements that support floors. [F20,F22-OS3.7] Applies to walls, and elements that support walls, that contain doors or windows required for emergency egress.
<b>9.20.17.3. Openings in Non-Loadbearing Flat Insulating Concrete Form Walls</b>	
(1)	[F20-OS2.1,OS2.3] [F22-OS2.3,OS2.4]
	[F20-OP2.1,OP2.3] [F22-OP2.3,OP2.4]
	[F20,F22-OH1.1,OH1.2,OH1.3]
	[F20,F22-OH4] Applies to floors and elements that support floors.
	[F20,F22-OS3.1] Applies to floors and elements that support floors. [F20,F22-OS3.7] Applies to walls, and elements that support walls, that contain doors or windows required for emergency egress.
(2)	[F20-OS2.1] [F22-OS2.4] [F20,F22-OS2.3] Applies to elements that support or are part of an environmental separator.
	[F20-OP2.1] [F22-OP2.4] [F20,F22-OP2.3] Applies to elements that support or are part of an environmental separator.
	[F20,F22-OH1.1,OH1.2,OH1.3] Applies to elements that support or are part of an environmental separator.
	[F20,F22-OH4] Applies to floors and elements that support floors.
	[F20,F22-OS3.1] Applies to floors and elements that support floors. [F20,F22-OS3.7] Applies to walls, and elements that support walls, that contain doors or windows required for emergency egress.
(3)	[F20-OS2.1] [F22-OS2.4] [F20,F22-OS2.3] Applies to elements that support or are part of an environmental separator.
	[F20-OP2.1] [F22-OP2.4] [F20,F22-OP2.3] Applies to elements that support or are part of an environmental separator.
	[F20,F22-OH1.1,OH1.2,OH1.3] Applies to elements that support or are part of an environmental separator.
	[F20,F22-OH4] Applies to floors and elements that support floors.
	[F20,F22-OS3.1] Applies to floors and elements that support floors. [F20,F22-OS3.7] Applies to walls, and elements that support walls, that contain doors or windows required for emergency egress.
(4)	[F20-OS2.1] [F22-OS2.4] [F20,F22-OS2.3] Applies to elements that support or are part of an environmental separator.
	[F20-OP2.1] [F22-OP2.4] [F20,F22-OP2.3] Applies to elements that support or are part of an environmental separator.
	[F20,F22-OH1.1,OH1.2,OH1.3] Applies to elements that support or are part of an environmental separator.
	[F20,F22-OH4] Applies to floors and elements that support floors.

	[F20,F22-OS3.1] Applies to floors and elements that support floors. [F20,F22-OS3.7] Applies to walls, and elements that support walls, that contain doors or windows required for emergency egress.
(5)	[F20-OS2.1] [F22-OS2.4] [F20,F22-OS2.3] Applies to elements that support or are part of an environmental separator.
	[F20-OP2.1] [F22-OP2.4] [F20,F22-OP2.3] Applies to elements that support or are part of an environmental separator.
	[F20,F22-OH1.1,OH1.2,OH1.3] Applies to elements that support or are part of an environmental separator.
	[F20,F22-OH4] Applies to floors and elements that support floors.
	[F20,F22-OS3.1] Applies to floors and elements that support floors. [F20,F22-OS3.7] Applies to walls, and elements that support walls, that contain doors or windows required for emergency egress.
(6)	[F20-OS2.1] [F22-OS2.4] [F20,F22-OS2.3] Applies to elements that support or are part of an environmental separator.
	[F20-OP2.1] [F22-OP2.4] [F20,F22-OP2.3] Applies to elements that support or are part of an environmental separator.
	[F20,F22-OH1.1,OH1.2,OH1.3] Applies to elements that support or are part of an environmental separator.
	[F20,F22-OH4] Applies to floors and elements that support floors.
	[F20,F22-OS3.1] Applies to floors and elements that support floors. [F20,F22-OS3.7] Applies to walls, and elements that support walls, that contain doors or windows required for emergency egress.
<b>9.20.17.4. Openings in Loadbearing Flat Insulating Concrete Form Walls</b>	
(1)	[F20-OS2.1] [F22-OS2.4] [F20,F22-OS2.3] Applies to elements that support or are part of an environmental separator.
	[F20-OP2.1] [F22-OP2.4] [F20,F22-OP2.3] Applies to elements that support or are part of an environmental separator.
	[F20,F22-OH1.1,OH1.2,OH1.3] Applies to elements that support or are part of an environmental separator.
	[F20,F22-OH4] Applies to floors and elements that support floors.
	[F20,F22-OS3.1] Applies to floors and elements that support floors. [F20,F22-OS3.7] Applies to walls, and elements that support walls, that contain doors or windows required for emergency egress.
(2)	[F20-OS2.1] [F22-OS2.4] [F20,F22-OS2.3] Applies to elements that support or are part of an environmental separator.
	[F20-OP2.1] [F22-OP2.4] [F20,F22-OP2.3] Applies to elements that support or are part of an environmental separator.
	[F20,F22-OH1.1,OH1.2,OH1.3] Applies to elements that support or are part of an environmental separator.

	[F20,F22-OH4] Applies to floors and elements that support floors.
	[F20,F22-OS3.1] Applies to floors and elements that support floors. [F20,F22-OS3.7] Applies to walls, and elements that support walls, that contain doors or windows required for emergency egress.
(3)	[F20-OS2.1] [F22-OS2.4] [F20,F22-OS2.3] Applies to elements that support or are part of an environmental separator.
	[F20-OP2.1] [F22-OP2.4] [F20,F22-OP2.3] Applies to elements that support or are part of an environmental separator.
	[F20,F22-OH1.1,OH1.2,OH1.3] Applies to elements that support or are part of an environmental separator.
	[F20,F22-OH4] Applies to floors and elements that support floors.
	[F20,F22-OS3.1] Applies to floors and elements that support floors. [F20,F22-OS3.7] Applies to walls, and elements that support walls, that contain doors or windows required for emergency egress.
(4)	[F20-OS2.1] [F20-OS2.3] Applies to elements that support or are part of an environmental separator.
	[F20-OP2.1] [F20-OP2.3] Applies to elements that support or are part of an environmental separator.
	[F20-OH1.1,OH1.2,OH1.3] Applies to elements that support or are part of an environmental separator.
	[F20-OH4] Applies to floors and elements that support floors.
	[F20-OS3.1] Applies to floors and elements that support floors.
<b>9.20.17.5. Framing Supported on Flat Insulating Concrete Form Walls</b>	
(1)	[F20-OS2.1] [F22-OS2.4] [F20,F22-OS2.3] Applies to elements that support or are part of an environmental separator.
	[F20-OP2.1] [F22-OP2.4] [F20,F22-OP2.3] Applies to elements that support or are part of an environmental separator.
	[F20,F22-OH4]
	[F20,F22-OS3.1]
(2)	[F20-OS2.1] [F22-OS2.4] [F20,F22-OS2.3] Applies to elements that support or are part of an environmental separator.
	[F20-OP2.1] [F22-OP2.4] [F20,F22-OP2.3] Applies to elements that support or are part of an environmental separator.
	[F20,F22-OH4]
	[F20,F22-OS3.1]
(3)	[F20-OS2.1] [F22-OS2.4] [F20,F22-OS2.3] Applies to elements that support or are part of an environmental separator.
	[F20-OP2.1] [F22-OP2.4] [F20,F22-OP2.3] Applies to elements that support or are part of an environmental separator.

	[F20,F22-OH4]
	[F20,F22-OS3.1]
<b>9.20.17.6. Anchoring of Roof Framing to the Top of Flat Insulating Concrete Form Walls</b>	
(1)	[F20-OS2.1,OS2.3] [F22-OS2.3,OS2.4]
	[F20-OP2.1,OP2.3] [F22-OP2.3,OP2.4]
	[F20,F22-OH1.1,OH1.2,OH1.3]
(2)	[F20-OS2.1,OS2.3] [F22-OS2.3,OS2.4]
	[F20-OP2.1,OP2.3] [F22-OP2.3,OP2.4]
	[F20-OH1.1,OH1.2,OH1.3]
<b>9.21.1.2. Chimney or Flue Pipe Walls</b>	
(1)	[F01-OS1.1] Applies to the walls of any <i>chimney</i> or <i>flue pipe</i> , which are required to be constructed to be flame-tight.
	[F44-OH1.1] Applies to the walls of any <i>chimney</i> or <i>flue pipe</i> , which are required to be constructed to be smoke-tight.
	[F01-OP1.1] Applies to the walls of any <i>chimney</i> or <i>flue pipe</i> , which are required to be constructed to be flame-tight.
<b>9.21.2.1. Chimney Flue Limitations</b>	
(1)	[F44-OH1.1]
	[F44-OS3.4]
(2)	[F44-OH1.1]
	[F44-OS3.4]
(3)	[F44-OS3.4]
	[F44-OH1.1]
<b>9.21.2.2. Connections of More Than One Appliance</b>	
(1)	[F44-OH1.1]
	[F44-OS3.4]
(2)	[F44-OS3.4]
(3)	[F44-OH1.1]
	[F44-OS3.4]
(4)	[F44-OH1.1]
	[F44-OS3.4]
<b>9.21.2.3. Inclined Chimney Flues</b>	
(1)	[F44-OH1.1]
	[F44-OS3.4]
<b>9.21.2.4. Size of Chimney Flues</b>	
(2)	[F44-OH1.1]
	[F44-OS3.4]
<b>9.21.2.5. Fireplace Chimneys</b>	



(1)	[F44-OH1.1]
	[F44-OS3.4]
<b>9.21.2.6. Oval Chimney Flues</b>	
(1)	[F44-OH1.1]
	[F44-OS3.4]
<b>9.21.3.1. Lining Materials</b>	
(1)	[F20-OS2.3]
	[F20-OH1.1]
	[F01-OS1.1]
	[F44-OS3.4]
	[F44,F01,F20-OP1.1]
<b>9.21.3.2. Joints in Chimney Liners</b>	
(1)	[F44-OH1.1]
	[F44,F20-OS2.3]
	[F01-OS1.1]
	[F01-OP1.1]
	[F01-OS3.4]
(2)	[F01-OS1.1]
	[F44-OS3.4]
	[F01-OP1.1]
	[F44-OH1.1]
<b>9.21.3.3. Clay Liners</b>	
(1)	[F20-OS2.2]
	[F01-OS1.1]
	[F20,F44-OS3.4]
	[F20,F44-OH1.1]
	[F20,F01-OP1.1]
(2)	[F44-OH1.1]
	[F01,F20-OP1.1]
	[F44-OS3.4]
	[F01,F20-OS1.1]
	[F20-OS2.3] Applies to the liners referred to in Sentence 9.21.3.3.(1), which are required to be not less than 15.9 mm thick.
<b>9.21.3.4. Firebrick Liners</b>	
(1)	[F20,F44-OS3.4]
	[F44-OH1.1]
	[F01-OS1.1]

	[F01-OP1.1]
(2)	[F20-OH1.1]
	[F20,F01-OS1.1]
	[F20-OS2.2]
	[F20,F44-OS3.4]
	[F01,F20-OP1.1]
<b>9.21.3.5. Concrete Liners</b>	
(1)	[F01,F20-OS1.1]
	[F44-OH1.1]
	[F20,F44-OS3.4]
	[F01-OP1.1]
	[F20-OS2.3]
<b>9.21.3.6. Metal Liners</b>	
(1)	[F20,F44-OH1.1]
	[F01,F20-OP1.1]
	[F20,F44-OS3.4]
	[F20,F01-OS1.1]
	[F20-OS2.3]
(2)	[F44-OH1.1]
	[F20-OS2.3]
	[F20-OP1.1]
	[F20,F44-OS3.4]
	[F20,F01-OS1.1]
<b>9.21.3.7. Installation of Chimney Liners</b>	
(1)	[F44-OH1.1]
	[F01-OP1.1]
	[F44-OS3.4]
	[F01-OS1.1]
	[F20-OS2.3]
<b>9.21.3.8. Spaces between Liners and Surrounding Masonry</b>	
(1)	[F01-OP1.1]
	[F20-OS2.3]
	[F01-OS1.1]
(2)	[F20-OS1.1]
	[F44-OH1.1]
	[F44-OS3.4]
	[F01-OP1.1]

	[F20-OS2.3]
<b>9.21.3.9. Mortar for Chimney Liners</b>	
(1)	(b) [F20-OS2.3]
	(a),(b) [F01,F20-OP1.1]
	[F20,F44-OH1.1]
	[F20,F44-OS3.4]
	(a),(b) [F01,F20-OS1.1]
(2)	[F20,F01-OP1.1]
	[F20,F44-OH1.1]
	[F20-OS2.3]
	[F44-OS3.4]
	[F20,F01-OS1.1]
<b>9.21.3.10. Extension of Chimney Liners</b>	
(1)	[F20-OS2.3]
	[F44,F20-OH1.1]
	[F44-OS3.4]
	[F01-OS1.1]
	[F01-OP1.1]
<b>9.21.4.4. Height of Chimney Flues</b>	
(1)	(a),(b) [F44-OH1.1]
	(a),(b) [F44-OS3.4]
<b>9.21.4.6. Chimney Caps</b>	
(1)	[F20-OS2.3]
	[F01-OS1.1]
	[F01-OP1.1]
	[F20,F44-OH1.1]
	[F44-OS3.4]
(2)	[F20-OS2.3]
(3)	[F20-OS2.3]
	[F20,F01-OS1.1]
	[F20,F01-OP1.1]
	[F20,F44-OS3.4]
(4)	[F20-OS2.3]
	[F20,F01-OS1.1]
	[F20,F01-OP1.1]
	[F20,F44-OH1.1]
	[F20,F44-OS3.4]

<b>9.21.4.7. Cleanout</b>	
(1)	[F01-OP1.1]
	[F01-OS1.1]
<b>9.21.4.8. Wall Thickness</b>	
(1)	[F20,F22-OS2.1]
	[F01-OP1.1]
	[F01-OS1.1]
	[F22-OP2.1]
<b>9.21.4.9. Separation of Flue Liners</b>	
(1)	[F20,F44-OH1.1]
	[F20,F01-OP1.1]
	[F20,F22-OS2.3]
	[F44-OS3.4]
	[F01-OS1.1]
(2)	[F20,F22-OS2.3]
	[F20,F44-OH1.1]
	[F20,F44-OS3.4]
	[F01-OS1.1]
<b>9.21.4.10. Flashing</b>	
(1)	[F20,F61-OS2.3]
<b>9.21.5.1. Clearance from Combustible Materials</b>	
(1)	(a),(b) [F01-OP1.1]
	(a),(b) [F01-OS1.1]
(2)	[F01-OP1.1]
	[F01-OS1.1]
(3)	[F01-OP1.1]
	[F01-OS1.1]
<b>9.21.5.2. Sealing of Spaces</b>	
(1)	[F01-OP1.1]
	[F01-OS1.1]
<b>9.21.5.3. Support of Joists or Beams</b>	
(1)	[F01-OP1.1]
	[F01-OS1.1]
<b>9.22.1.2. Masonry and Concrete</b>	
(2)	[F22,F20-OS2.3]
<b>9.22.1.4. Combustion Air</b>	
(1)	[F01-OS1.1]

	[F01-OP1.1]
<b>9.22.2.1. Brick or Steel Liners</b>	
(1)	[F20,F01-OS1.1]
	[F20,F01-OP1.1]
<b>9.22.2.2. Firebrick Liners</b>	
(1)	(a),(b) [F01-OS1.1]
	(a),(b) [F01-OP1.1]
(2)	[F01-OS1.1]
	[F01-OP1.1]
(3)	[F01-OS1.1]
	[F01-OP1.1]
<b>9.22.2.3. Steel Liners</b>	
(1)	[F44-OH1.1]
	[F01-OS1.1]
	[F44-OS3.4]
	[F01-OP1.1]
<b>9.22.3.1. Thickness of Walls</b>	
(1)	[F01-OS1.1]
	[F01-OP1.1]
(2)	(a),(b) [F01-OS1.1]
	(a),(b) [F01-OP1.1]
<b>9.22.4.1. Fire Chamber Dimensions</b>	
(1)	[F44-OH1.1]
	[F44-OS3.4]
<b>9.22.5.1. Hearth Extension</b>	
(1)	[F01-OS1.1]
	[F01-OP1.1]
(2)	(a),(b) [F01-OS1.1]
	(a),(b) [F01-OP1.1]
<b>9.22.5.2. Support of Hearth</b>	
(1)	[F01-OS1.1]
	[F20-OS2.3]
	[F20,F01-OP1.1]
(2)	[F01-OS1.1]
	[F01-OP1.1]
<b>9.22.6.1. Required Damper and Size</b>	
(1)	[F01-OS1.1]

	[F54-OH1.2]
	[F01-OP1.1]
<b>9.22.7.1. Slope of Smoke Chamber</b>	
(1)	[F44-OH1.1]
	[F44-OS3.4]
<b>9.22.7.2. Wall Thickness</b>	
(1)	[F01-OS1.1]
	[F01-OP1.1]
<b>9.22.8.1. Conformance to Standard</b>	
(1)	[F01-OS1.1]
	[F44-OH1.1]
	[F01-OP1.1]
	[F44-OS3.4]
<b>9.22.9.1. Clearance to the Fireplace Opening</b>	
(1)	[F01-OS1.1]
	[F01-OP1.1]
<b>9.22.9.2. Metal Exposed to the Interior</b>	
(1)	[F01-OS1.1]
	[F01-OP1.1]
<b>9.22.9.3. Clearance to Combustible Framing</b>	
(1)	[F01-OS1.1]
	[F01-OP1.1]
(2)	[F01-OS1.1]
	[F01-OP1.1]
<b>9.22.9.4. Heat-Circulating Duct Outlets</b>	
(1)	(a),(b) [F01-OS1.1]
	(a),(b) [F01-OP1.1]
<b>9.22.10.1. Appliance Standard</b>	
(1)	[F44-OH1.1]
	[F01-OS1.1]
	[F44-OS3.4]
	[F01-OP1.1]
<b>9.22.10.2. Installation</b>	
(1)	[F01-OS1.1]
	[F44-OH1.1]
	[F01-OP1.1]
	[F44-OS3.4]

<b>9.23.2.1. Strength and Rigidity</b>	
(1)	[F20-OS2.1] [F20,F22-OS2.5] [F20,F22-OS2.3] Applies to elements that support or are part of an environmental separator.
	[F20-OP2.1] [F20,F22-OP2.4,OP2.5] [F20,F22-OP2.3] Applies to elements that support or are part of an environmental separator.
	[F22-OH4] Applies to floors and elements that support floors.
	[F20,F22-OS1.2] Applies to assemblies required to provide fire resistance.
	[F22-OS3.1] Applies to floors and elements that support floors. [F22-OS3.7] Applies to walls, and elements that support walls, that contain doors or windows required for emergency egress.
	[F20,F22-OH1.1,OH1.2,OH1.3] Applies to elements that support or are part of an environmental separator.
<b>9.23.2.2. Protection from Decay</b>	
(1)	[F80-OS2.3]
	[F80-OP2.3,OP2.4]
	[F80-OH1.1,OH1.2,OH1.3] Applies to elements that support or are part of an environmental separator.
	[F80-OS1.2] Applies to assemblies required to provide fire resistance.
	[F80-OH4] Applies to floors and elements that support floors.
	[F80-OS3.1] Applies to floors and elements that support floors. [F80-OS3.7] Applies to walls, and elements that support walls, that contain doors or windows required for emergency egress.
(2)	[F81-OS2.3]
	[F81-OP2.3]
	[F81-OH1.1,OH1.2,OH1.3] Applies to elements that support or are part of an environmental separator.
	[F81-OS1.2] Applies to assemblies required to provide fire resistance.
	[F81-OH4] Applies to floors and elements that support floors.
	[F81-OS3.1] Applies to floors and elements that support floors.
<b>9.23.2.3. Protection from Dampness</b>	
(1)	[F80-OS2.1,OS2.3]
	[F80-OP2.1,OP2.3,OP2.4]
	[F80-OH1.1,OH1.2,OH1.3] Applies to elements that support or are part of an environmental separator.
	[F80-OS1.2] Applies to assemblies required to provide fire resistance.
	[F80-OH4] Applies to floors and elements that support floors.
	[F80-OS3.1] Applies to floors and elements that support floors.
<b>9.23.2.4. Connections to Preservative-Treated Wood</b>	
(1)	[F20,F80-OS2.3]
	[F20,F80-OP2.3]
(2)	[F20,F80-OS2.3]
	[F20,F80-OP2.3]

(3)	[F20,F80-OS2.3]
	[F20,F80-OP2.3]
<b>9.23.3.1. Standards for Nails and Screws</b>	
(1)	[F20-OS2.1] [F20,F22-OS2.5] [F20,F22-OS2.3] Applies to elements that support or are part of an environmental separator.
	[F20-OP2.1] [F20,F22-OP2.4,OP2.5] [F20,F22-OP2.3] Applies to elements that support or are part of an environmental separator.
	[F20,F22-OS1.2] Applies to assemblies required to provide fire resistance.
	[F20,F22-OH1.1,OH1.2,OH1.3] Applies to elements that support or are part of an environmental separator.
	[F22-OH4] Applies to floors and elements that support floors.
	[F22-OS3.1] Applies to floors and elements that support floors. [F22-OS3.7] Applies to walls, and elements that support walls, that contain doors or windows required for emergency egress.
(2)	[F20-OS2.1] [F20,F22-OS2.5] [F20,F22-OS2.3] Applies to elements that support or are part of an environmental separator.
	[F20-OP2.1] [F20,F22-OP2.4,OP2.5] [F20,F22-OP2.3] Applies to elements that support or are part of an environmental separator.
	[F20,F22-OS1.2] Applies to assemblies required to provide fire resistance.
	[F20,F22-OH1.1,OH1.2,OH1.3] Applies to elements that support or are part of an environmental separator.
	[F22-OH4] Applies to floors and elements that support floors.
	[F22-OS3.1] Applies to floors and elements that support floors. [F22-OS3.7] Applies to walls, and elements that support walls, that contain doors or windows required for emergency egress.
(3)	[F20-OS2.1] [F20,F22-OS2.5] [F20,F22-OS2.3] Applies to elements that support or are part of an environmental separator.
	[F20-OP2.1,OP2.5] [F22-OP2.4,OP2.5] [F20,F22-OP2.3] Applies to elements that support or are part of an environmental separator.
	[F20,F22-OH1.1,OH1.2,OH1.3] Applies to elements that support or are part of an environmental separator.
	[F20,F22-OS1.2] Applies to assemblies required to provide fire resistance.
	[F22-OH4] Applies to floors and elements that support floors.
	[F22-OS3.1] Applies to floors and elements that support floors. [F22-OS3.7] Applies to walls, and elements that support walls, that contain doors or windows required for emergency egress.
<b>9.23.3.2. Length of Nails</b>	
(1)	[F20-OS2.1] [F20,F22-OS2.5] [F20,F22-OS2.3] Applies to elements that support or are part of an environmental separator.



	[F20-OP2.1,OP2.5] [F22-OP2.4,OP2.5] [F20,F22-OP2.3] Applies to elements that support or are part of an environmental separator.
	[F20,F22-OH1.1,OH1.2,OH1.3] Applies to elements that support or are part of an environmental separator.
	[F20,F22-OS1.2] Applies to assemblies required to provide fire resistance.
	[F22-OH4] Applies to floors and elements that support floors.
	[F22-OS3.1] Applies to floors and elements that support floors. [F22-OS3.7] Applies to walls, and elements that support walls, that contain doors or windows required for emergency egress.
<b>9.23.3.3. Prevention of Splitting</b>	
(1)	[F80-OS2.1] [F80-OS2.3] Applies to elements that support or are part of an environmental separator.
	[F80-OP2.1,OP2.4] [F80-OP2.3] Applies to elements that support or are part of an environmental separator.
	[F80-OH1.1,OH1.2,OH1.3] Applies to elements that support or are part of an environmental separator.
	[F80-OS1.2] Applies to assemblies required to provide fire resistance.
	[F80-OH4] Applies to floors and elements that support floors.
	[F80-OS3.1] Applies to floors and elements that support floors.
<b>9.23.3.4. Nailing of Framing</b>	
(1)	[F20-OS2.1] [F20,F22-OS2.5] [F20,F22-OS2.3] Applies to elements that support or are part of an environmental separator.
	[F20-OP2.1,OP2.5] [F22-OP2.4,OP2.5] [F20,F22-OP2.3] Applies to elements that support or are part of an environmental separator.
	[F20,F22-OH1.1,OH1.2,OH1.3] Applies to elements that support or are part of an environmental separator.
	[F22-OH4] Applies to floors and elements that support floors.
	[F20,F22-OS1.2] Applies to assemblies required to provide fire resistance.
	[F22-OS3.1] Applies to floors and elements that support floors. [F22-OS3.7] Applies to walls, and elements that support walls, that contain doors or windows required for emergency egress.
(2)	[F20-OS2.1] [F20,F22-OS2.5] [F20,F22-OS2.3] Applies to elements that support or are part of an environmental separator.
	[F20-OP2.1,OP2.5] [F22-OP2.4,OP2.5] [F20,F22-OP2.3] Applies to elements that support or are part of an environmental separator.
	[F20,F22-OH1.1,OH1.2,OH1.3] Applies to elements that support or are part of an environmental separator.
	[F20,F22-OS1.2] Applies to assemblies required to provide fire resistance.
	[F22-OH4] Applies to floors and elements that support floors.

	[F22-OS3.1] Applies to floors and elements that support floors. [F22-OS3.7] Applies to walls, and elements that support walls, that contain doors or windows required for emergency egress.
(3)	[F20-OS2.1] [F20,F22-OS2.3] [F20,F22-OS2.5]
	[F20-OP2.1,OP2.5] [F20,F22-OP2.3] [F22-OP2.4,OP2.5]
	[F20,F22-OH1.1,OH1.2,OH1.3]
	[F20,F22-OS1.2] Applies to assemblies required to provide fire resistance.
(4)	[F20-OS2.1] [F20,F22-OS2.3] [F20,F22-OS2.5]
	[F20-OP2.1,OP2.5] [F20,F22-OP2.3] [F22-OP2.4,OP2.5]
	[F20,F22-OH1.1,OH1.2,OH1.3]
	[F20,F22-OS1.2] Applies to assemblies required to provide fire resistance.
<b>9.23.3.5. Fasteners for Sheathing or Subflooring</b>	
(1)	[F22-OH4] Applies to floors and elements that support floors.
	[F20,F22-OS1.2] Applies to assemblies required to provide fire resistance.
	[F22-OS3.1] Applies to floors and elements that support floors. [F22-OS3.7] Applies to walls, and elements that support walls, that contain doors or windows required for emergency egress.
	[F20-OS2.1] [F20,F22-OS2.5] [F20,F22-OS2.3] Applies to elements that support or are part of an environmental separator.
	[F20-OP2.1,OP2.5] [F22-OP2.4,OP2.5] [F20,F22-OP2.3] Applies to elements that support or are part of an environmental separator.
	[F20,F22-OH1.1,OH1.2,OH1.3] Applies to elements that support or are part of an environmental separator.
(2)	[F22-OH4] Applies to floors and elements that support floors.
	[F22-OS3.1] Applies to floors and elements that support floors. [F22-OS3.7] Applies to walls, and elements that support walls, that contain doors or windows required for emergency egress.
	[F20-OS2.1] [F20,F22-OS2.5] [F20,F22-OS2.3] Applies to elements that support or are part of an environmental separator.
	[F20-OP2.1,OP2.5] [F22-OP2.4,OP2.5] [F20,F22-OP2.3] Applies to elements that support or are part of an environmental separator.
	[F20,F22-OH1.1,OH1.2,OH1.3] Applies to elements that support or are part of an environmental separator.
(3)	[F22-OH4] Applies to floors and elements that support floors.
	[F22-OS3.1] Applies to floors and elements that support floors. [F22-OS3.7] Applies to walls, and elements that support walls, that contain doors or windows required for emergency egress.
	[F20-OS2.1] [F20,F22-OS2.5] [F20,F22-OS2.3] Applies to elements that support or are part of an environmental separator.
	[F20-OP2.1,OP2.5] [F22-OP2.4,OP2.5] [F20,F22-OP2.3] Applies to elements that support or are part of an environmental separator.
	[F20,F22-OH1.1,OH1.2,OH1.3] Applies to elements that support or are part of an environmental separator.

(5)	[F20-OS2.1] [F20,F22-OS2.5] [F20,F22-OS2.3] Applies to elements that support or are part of an environmental separator.
	[F20-OP2.1,OP2.5] [F22-OP2.4,OP2.5] [F20,F22-OP2.3] Applies to elements that support or are part of an environmental separator.
	[F20,F22-OH1.1,OH1.2,OH1.3] Applies to elements that support or are part of an environmental separator.
	[F22-OH4] Applies to floors and elements that support floors.
	[F20,F22-OS1.2] Applies to assemblies required to provide fire resistance.
	[F22-OS3.1] Applies to floors and elements that support floors. [F22-OS3.7] Applies to walls, and elements that support walls, that contain doors or windows required for emergency egress.
(6)	[F20-OS2.1] [F20,F22-OS2.5] [F20,F22-OS2.3] Applies to elements that support or are part of an environmental separator.
	[F20-OP2.1,OP2.5] [F22-OP2.4,OP2.5] [F20,F22-OP2.3] Applies to elements that support or are part of an environmental separator.
	[F20,F22-OH1.1,OH1.2,OH1.3] Applies to elements that support or are part of an environmental separator.
	[F22-OH4] Applies to floors and elements that support floors.
	[F20,F22-OS1.2] Applies to assemblies required to provide fire resistance.
	[F22-OS3.1] Applies to floors and elements that support floors. [F22-OS3.7] Applies to walls, and elements that support walls, that contain doors or windows required for emergency egress.
(7)	[F20,F22-OS2.1]
	[F20-OP2.1] [F22-OP2.4]
	[F22-OH4] Applies to floors and elements that support floors.
	[F22-OS3.1] Applies to floors and elements that support floors.
	[F20-OS1.2] Applies to assemblies required to provide fire resistance.
(8)	[F20-OS2.1] [F20,F22-OS2.5] [F20,F22-OS2.3] Applies to elements that support or are part of an environmental separator.
	[F20-OP2.1,OP2.5] [F22-OP2.4,OP2.5] [F20,F22-OP2.3] Applies to elements that support or are part of an environmental separator.
	[F20,F22-OH1.1,OH1.2,OH1.3] Applies to elements that support or are part of an environmental separator.
<b>9.23.4.2. Spans for Joists, Rafters and Beams</b>	
(1)	[F20-OS2.1,OS2.5] [F22-OS2.4,OS2.5] [F20,F22-OS2.3] Applies to elements that support or are part of an environmental separator.
	[F20-OP2.1,OP2.5] [F22-OP2.4,OP2.5] [F20,F22-OP2.3] Applies to elements that support or are part of an environmental separator.
	[F20,F22-OH1.1,OH1.2,OH1.3] Applies to elements that support or are part of an environmental separator.

	[F22-OH4] Applies to floors and elements that support floors.
	[F20,F22-OS1.2] Applies to assemblies required to provide fire resistance.
	[F22-OS3.1] Applies to floors and elements that support floors. [F22-OS3.7] Applies to walls, and elements that support walls, that contain doors or windows required for emergency egress.
(2)	[F20-OS2.1,OS2.5] [F22-OS2.4,OS2.5] [F20,F22-OS2.3] Applies to elements that support or are part of an environmental separator.
	[F20-OP2.1,OP2.5] [F22-OP2.4,OP2.5] [F20,F22-OP2.3] Applies to elements that support or are part of an environmental separator.
	[F20,F22-OH1.1,OH1.2,OH1.3] Applies to elements that support or are part of an environmental separator.
	[F22-OH4] Applies to floors and elements that support floors.
	[F20,F22-OS1.2] Applies to assemblies required to provide fire resistance.
	[F22-OS3.1] Applies to floors and elements that support floors. [F22-OS3.7] Applies to walls, and elements that support walls, that contain doors or windows required for emergency egress.
(3)	[F20-OS2.1,OS2.3,OS2.5]
	[F20-OP2.1,OP2.3,OP2.5]
(4)	[F20-OS2.1,OS2.3,OS2.5]
	[F20-OP2.1,OP2.3,OP2.5]
<b>9.23.4.3. Steel Beams</b>	
(1)	[F20-OS2.1,OS2.5] [F22-OS2.4,OS2.5] [F20,F22-OS2.3] Applies to elements that support or are part of an environmental separator.
	[F20-OP2.1,OP2.5] [F22-OP2.4,OP2.5] [F20,F22-OP2.3] Applies to elements that support or are part of an environmental separator.
	[F20,F22-OH1.1,OH1.2,OH1.3] Applies to elements that support or are part of an environmental separator.
	[F20,F22-OS1.2] Applies to assemblies required to provide fire resistance.
	[F22-OS3.1] Applies to floors and elements that support floors. [F22-OS3.7] Applies to walls, and elements that support walls, that contain doors or windows required for emergency egress.
	[F22-OH4] Applies to floors and elements that support floors.
(2)	[F20-OS2.1,OS2.5] [F22-OS2.4,OS2.5] [F20,F22-OS2.3] Applies to elements that support or are part of an environmental separator.
	[F20-OP2.1,OP2.5] [F22-OP2.4,OP2.5] [F20,F22-OP2.3] Applies to elements that support or are part of an environmental separator.
	[F20,F22-OH1.1,OH1.2,OH1.3] Applies to elements that support or are part of an environmental separator.
	[F20,F22-OS1.2] Applies to assemblies required to provide fire resistance.

	[F22-OS3.1] Applies to floors and elements that support floors. [F22-OS3.7] Applies to walls, and elements that support walls, that contain doors or windows required for emergency egress.
	[F22-OH4] Applies to floors and elements that support floors.
<b>9.23.4.4. Concrete Topping</b>	
(1)	[F20-OS2.1,OS2.5] [F22-OS2.4,OS2.5] [F20,F22-OS2.3] Applies to elements that support or are part of an environmental separator.
	[F20-OP2.1,OP2.5] [F22-OP2.4,OP2.5] [F20,F22-OP2.3] Applies to elements that support or are part of an environmental separator.
	[F22-OH4] Applies to floors and elements that support floors.
	[F20,F22-OH1.1,OH1.2,OH1.3] Applies to elements that support or are part of an environmental separator.
	[F20,F22-OS1.2] Applies to assemblies required to provide fire resistance.
	[F22-OS3.1] Applies to floors and elements that support floors. [F22-OS3.7] Applies to walls, and elements that support walls, that contain doors or windows required for emergency egress.
(2)	[F20-OS2.1,OS2.5] [F22-OS2.4,OS2.5] [F20,F22-OS2.3] Applies to elements that support or are part of an environmental separator.
	[F20-OP2.1,OP2.5] [F22-OP2.4,OP2.5] [F20,F22-OP2.3] Applies to elements that support or are part of an environmental separator.
	[F20,F22-OH1.1,OH1.2,OH1.3] Applies to elements that support or are part of an environmental separator.
	[F22-OH4] Applies to floors and elements that support floors.
	[F20,F22-OS1.2] Applies to assemblies required to provide fire resistance.
	[F22-OS3.1] Applies to floors and elements that support floors. [F22-OS3.7] Applies to walls, and elements that support walls, that contain doors or windows required for emergency egress.
(3)	[F20-OS2.1,OS2.5] [F22-OS2.4,OS2.5] [F20,F22-OS2.3] Applies to elements that support or are part of an environmental separator.
	[F20-OP2.1,OP2.5] [F22-OP2.4,OP2.5] [F20,F22-OP2.3] Applies to elements that support or are part of an environmental separator.
	[F20,F22-OH1.1,OH1.2,OH1.3] Applies to elements that support or are part of an environmental separator.
	[F20,F22-OS1.2] Applies to assemblies required to provide fire resistance.
	[F20,F22-OH4] Applies to floors and elements that support floors.
	[F22-OS3.1] Applies to floors and elements that support floors. [F22-OS3.7] Applies to elements that support walls that contain doors or windows required for emergency egress.
<b>9.23.4.5. Heavy Roofing Materials</b>	

(1)	[F20-OS2.1,OS2.5] [F22-OS2.4,OS2.5] [F20,F22-OS2.3] Applies to elements that support or are part of an environmental separator.
	[F20-OP2.1,OP2.5] [F22-OP2.4,OP2.5] [F20,F22-OP2.3] Applies to elements that support or are part of an environmental separator.
	[F20,F22-OH1.1,OH1.2,OH1.3] Applies to elements that support or are part of an environmental separator.
	[F20,F22-OS1.2] Applies to assemblies required to provide fire resistance.
	[F22-OS3.1] Applies to floors and elements that support floors. [F22-OS3.7] Applies to walls, and elements that support walls, that contain doors or windows required for emergency egress.
<b>9.23.5.1. Holes Drilled in Framing Members</b>	
(1)	[F20-OS2.1,OS2.5] [F22-OS2.5] [F20,F22-OS2.3] Applies to elements that support or are part of an environmental separator.
	[F20-OP2.1,OP2.5] [F22-OP2.4,OP2.5] [F20,F22-OP2.3] Applies to elements that support or are part of an environmental separator.
	[F20,F22-OH1.1,OH1.2,OH1.3] Applies to elements that support or are part of an environmental separator.
	[F20,F22-OS1.2] Applies to assemblies required to provide fire resistance.
	[F22-OS3.1] Applies to floors and elements that support floors. [F22-OS3.7] Applies to walls, and elements that support walls, that contain doors or windows required for emergency egress.
	[F22-OH4] Applies to floors and elements that support floors.
<b>9.23.5.2. Notching of Framing Members</b>	
(1)	[F20-OS2.1,OS2.5] [F22-OS2.5] [F20,F22-OS2.3] Applies to elements that support or are part of an environmental separator.
	[F20-OP2.1,OP2.5] [F22-OP2.4,OP2.5] [F20,F22-OP2.3] Applies to elements that support or are part of an environmental separator.
	[F20,F22-OH1.1,OH1.2,OH1.3] Applies to elements that support or are part of an environmental separator.
	[F20,F22-OS1.2] Applies to assemblies required to provide fire resistance.
	[F22-OS3.1] Applies to floors and elements that support floors. [F22-OS3.7] Applies to walls, and elements that support walls, that contain doors or windows required for emergency egress.
	[F22-OH4] Applies to floors and elements that support floors.
<b>9.23.5.3. Wall Studs</b>	
(1)	[F20-OS2.1,OS2.5] [F22-OS2.5] [F20,F22-OS2.3] Applies to elements that support or are part of an environmental separator.
	[F20-OP2.1,OP2.5] [F22-OP2.4,OP2.5] [F20,F22-OP2.3] Applies to elements that support or are part of an environmental separator.

	[F20,F22-OH1.1,OH1.2,OH1.3] Applies to elements that support or are part of an environmental separator.
	[F22-OH4] Applies to floors and elements that support floors.
	[F20,F22-OS1.2] Applies to assemblies required to provide fire resistance.
	[F22-OS3.1] Applies to floors and elements that support floors. [F22-OS3.7] Applies to walls, and elements that support walls, that contain doors or windows required for emergency egress.
<b>9.23.5.4. Top Plates</b>	
(1)	[F20-OS2.1,OS2.5] [F22-OS2.5] [F20,F22-OS2.3] Applies to elements that support or are part of an environmental separator.
	[F20-OP2.1,OP2.5] [F22-OP2.4,OP2.5] [F20,F22-OP2.3] Applies to elements that support or are part of an environmental separator.
	[F20,F22-OH1.1,OH1.2,OH1.3] Applies to elements that support or are part of an environmental separator.
	[F22-OH4] Applies to floors and elements that support floors.
	[F20,F22-OS1.2] Applies to assemblies required to provide fire resistance.
	[F22-OS3.1] Applies to floors and elements that support floors. [F22-OS3.7] Applies to walls, and elements that support walls, that contain doors or windows required for emergency egress.
<b>9.23.5.5. Roof Trusses</b>	
(1)	[F20-OS2.1,OS2.5] [F22-OS2.5] [F20,F22-OS2.3] Applies to elements that support or are part of an environmental separator.
	[F20-OP2.1,OP2.5] [F22-OP2.4,OP2.5] [F20,F22-OP2.3] Applies to elements that support or are part of an environmental separator.
	[F20,F22-OH1.1,OH1.2,OH1.3] Applies to elements that support or are part of an environmental separator.
	[F20,F22-OS1.2] Applies to assemblies required to provide fire resistance.
<b>9.23.6.1. Anchorage of Building Frames</b>	
(1)	[F20-OS2.1,OS2.5] [F22-OS2.5] [F20,F22-OS2.3] Applies to elements that support or are part of an environmental separator.
	[F20-OP2.1,OP2.5] [F22-OP2.4,OP2.5] [F20,F22-OP2.3] Applies to elements that support or are part of an environmental separator.
	[F20-OH1.1,OH1.2,OH1.3] Applies to elements that support or are part of an environmental separator.
	[F22-OH4] Applies to floors and elements that support floors.
	[F20-OS3.1] Applies to floors and elements that support floors.
(2)	[F20-OS2.1,OS2.5] [F22-OS2.5] [F20,F22-OS2.3] Applies to elements that support or are part of an environmental separator.

	[F20-OP2.1,OP2.5] [F22-OP2.4,OP2.5] [F20,F22-OP2.3] Applies to elements that support or are part of an environmental separator.
	[F20-OH1.1,OH1.2,OH1.3] Applies to elements that support or are part of an environmental separator.
	[F22-OH4] Applies to floors and elements that support floors.
	[F20-OS3.1] Applies to floors and elements that support floors.
(3)	[F20-OS2.1,OS2.5] [F22-OS2.5] [F20,F22-OS2.3] Applies to elements that support or are part of an environmental separator.
	[F20-OP2.1,OP2.5] [F22-OP2.4,OP2.5] [F20,F22-OP2.3] Applies to elements that support or are part of an environmental separator.
	[F20-OH1.1,OH1.2,OH1.3] Applies to elements that support or are part of an environmental separator.
	[F22-OH4] Applies to floors and elements that support floors.
	[F20-OS3.1] Applies to floors and elements that support floors.
(4)	[F20-OS2.1,OS2.5] [F22-OS2.5] [F20,F22-OS2.3] Applies to elements that support or are part of an environmental separator.
	[F20-OP2.1,OP2.5] [F22-OP2.4,OP2.5] [F20,F22-OP2.3] Applies to elements that support or are part of an environmental separator.
	[F20-OH1.1,OH1.2,OH1.3] Applies to elements that support or are part of an environmental separator.
	[F22-OH4] Applies to floors and elements that support floors.
	[F20-OS3.1] Applies to floors and elements that support floors.
(5)	[F20-OS2.1,OS2.5] [F22-OS2.5] [F20,F22-OS2.3] Applies to elements that support or are part of an environmental separator.
	[F20-OP2.1,OP2.5] [F22-OP2.4,OP2.5] [F20,F22-OP2.3] Applies to elements that support or are part of an environmental separator.
	[F20-OH1.1,OH1.2,OH1.3] Applies to elements that support or are part of an environmental separator.
	[F22-OH4] Applies to floors and elements that support floors.
	[F20,F22-OS3.1] Applies to floors and elements that support floors.
(6)	[F20-OS2.1,OS2.5] [F22-OS2.5] [F20,F22-OS2.3] Applies to elements that support or are part of an environmental separator.
	[F20-OP2.1,OP2.5] [F22-OP2.4,OP2.5] [F20,F22-OP2.3] Applies to elements that support or are part of an environmental separator.
	[F20-OH1.1,OH1.2,OH1.3] Applies to elements that support or are part of an environmental separator.
	[F22-OH4] Applies to floors and elements that support floors.
	[F20-OS3.1] Applies to floors and elements that support floors.
<b>9.23.6.2. Anchorage of Columns and Posts</b>	
(1)	[F22-OS2.4,OS2.5] [F22-OS2.3] Applies to elements that support or are part of an environmental separator.
	[F22-OP2.4,OP2.5] [F22-OP2.3] Applies to elements that support or are part of an environmental separator.
	[F22-OH1.1,OH1.2,OH1.3] Applies to elements that support or are part of an environmental separator.
	[F22-OH4] Applies to floors and elements that support floors.



	[F22-OS3.1] Applies to floors and elements that support floors. [F22-OS3.7] Applies to walls, and elements that support walls, that contain doors or windows required for emergency egress.
(2)	[F22-OS2.4,OS2.5] [F22-OS2.3] Applies to elements that support or are part of an environmental separator.
	[F22-OP2.4,OP2.5] [F22-OP2.3] Applies to elements that support or are part of an environmental separator.
	[F22-OH4] Applies to floors and elements that support floors.
	[F22-OS3.1] Applies to floors and elements that support floors.
	[F22-OH1.1,OH1.2,OH1.3] Applies to elements that support or are part of an environmental separator.
<b>9.23.6.3. Anchorage of Smaller Buildings</b>	
(1)	[F22-OS2.3,OS2.5]
<b>9.23.7.1. Size of Sill Plates</b>	
(1)	[F20-OS2.1,OS2.5] [F22-OS2.5] [F20,F22-OS2.3] Applies to elements that support or are part of an environmental separator.
	[F20-OP2.1,OP2.5] [F22-OP2.4,OP2.5] [F20,F22-OP2.3] Applies to elements that support or are part of an environmental separator.
	[F20,F22-OH1.1,OH1.2,OH1.3] Applies to elements that support or are part of an environmental separator.
	[F22-OH4] Applies to floors and elements that support floors.
	[F22-OS3.1] Applies to floors and elements that support floors. [F22-OS3.7] Applies to walls, and elements that support walls, that contain doors or windows required for emergency egress.
	[F22-OS1.2] Applies to assemblies required to provide fire resistance.
<b>9.23.7.2. Levelling and Sealing of Sill Plates</b>	
(1)	[F20-OS2.1,OS2.5] [F22-OS2.4,OS2.5] [F20,F22-OS2.3] Applies to elements that support or are part of an environmental separator.
	[F20-OP2.1,OP2.5] [F22-OP2.4,OP2.5] [F20,F22-OP2.3] Applies to elements that support or are part of an environmental separator.
	[F20,F22-OH1.1,OH1.2,OH1.3] Applies to elements that support or are part of an environmental separator.
	[F20,F22-OH4] Applies to floors and elements that support floors.
	[F20,F22-OS3.1] Applies to floors and elements that support floors.
<b>9.23.8.1. Bearing for Beams</b>	
(1)	[F20-OS2.1,OS2.5] [F22-OS2.5] [F20,F22-OS2.3] Applies to elements that support or are part of an environmental separator.
	[F20-OP2.1,OP2.5] [F22-OP2.5] [F20,F22-OP2.3] Applies to elements that support or are part of an environmental separator.

	[F20,F22-OH1.1,OH1.2,OH1.3] Applies to elements that support or are part of an environmental separator.
	[F20,F22-OH4] Applies to floors and elements that support floors.
	[F20,F22-OS3.1] Applies to floors and elements that support floors. [F20,F22-OS3.7] Applies to walls, and elements that support walls, that contain doors or windows required for emergency egress.
	[F20,F22-OS1.2] Applies to assemblies required to provide fire resistance.
<b>9.23.8.2. Priming of Steel Beams</b>	
(1)	[F80-OS2.1] [F80-OS2.3] Applies to elements that support or are part of an environmental separator.
	[F80-OP2.1,OP2.4] [F80-OP2.3] Applies to elements that support or are part of an environmental separator.
	[F80-OH1.1,OH1.2,OH1.3] Applies to elements that support or are part of an environmental separator.
	[F80-OS1.2] Applies to assemblies required to provide fire resistance.
	[F80-OS3.1] Applies to floors and elements that support floors.
	[F80-OH4] Applies to floors and elements that support floors.
<b>9.23.8.3. Built-up Wood Beams</b>	
(1)	[F20-OS2.1] [F20-OP2.1]
(2)	[F20-OS2.1] [F20-OP2.1]
(3)	[F20-OS2.1] [F20-OP2.1]
(4)	[F20-OS2.1] [F20-OP2.1]
(5)	[F20-OS2.1] [F20-OP2.1]
(6)	[F20-OS2.1] [F20-OP2.1]
(7)	[F20-OS2.1] [F20-OP2.1]
(8)	[F20-OS2.1] [F20-OP2.1]
<b>9.23.9.1. End Bearing for Joists</b>	
(1)	[F20-OS2.1,OS2.5] [F22-OS2.5] [F20,F22-OS2.3] Applies to elements that support or are part of an environmental separator.
	[F20-OP2.1,OP2.5] [F22-OP2.4,OP2.5] [F20,F22-OP2.3] Applies to elements that support or are part of an environmental separator.

	[F20,F22-OH1.1,OH1.2,OH1.3] Applies to elements that support or are part of an environmental separator.
	[F22-OH4]
	[F20,F22-OS1.2] Applies to assemblies required to provide fire resistance.
	[F22-OS3.1]
(2)	[F20,F22-OS1.2] Applies to assemblies required to provide fire resistance.
	[F22-OS3.1]
	[F20-OP2.1,OP2.5] [F22-OP2.4,OP2.5] [F20,F22-OP2.3] Applies to elements that support or are part of an environmental separator.
	[F22-OH4]
	[F20,F22-OH1.1,OH1.2,OH1.3] Applies to elements that support or are part of an environmental separator.
	[F20-OS2.1,OS2.5] [F22-OS2.5] [F20,F22-OS2.3] Applies to elements that support or are part of an environmental separator.
<b>9.23.9.2. Joists Supported by Beams</b>	
(1)	[F20-OS2.1,OS2.5] [F22-OS2.5] [F20,F22-OS2.3] Applies to elements that support or are part of an environmental separator.
	[F20-OP2.1,OP2.5] [F22-OP2.4,OP2.5] [F20,F22-OP2.3] Applies to elements that support or are part of an environmental separator.
	[F20,F22-OH1.1,OH1.2,OH1.3] Applies to elements that support or are part of an environmental separator.
	[F22-OH4]
	[F20,F22-OS1.2] Applies to assemblies required to provide fire resistance.
	[F22-OS3.1] [F22-OS3.7] Applies to walls, and elements that support walls, that contain doors or windows required for emergency egress.
(2)	[F20-OS2.1,OS2.5] [F22-OS2.5] [F20,F22-OS2.3] Applies to elements that support or are part of an environmental separator.
	[F20-OP2.1,OP2.5] [F22-OP2.4,OP2.5] [F20,F22-OP2.3] Applies to elements that support or are part of an environmental separator.
	[F20,F22-OH1.1,OH1.2,OH1.3] Applies to elements that support or are part of an environmental separator.
	[F22-OH4]
	[F20,F22-OS1.2] Applies to assemblies required to provide fire resistance.
	[F22-OS3.1] [F22-OS3.7] Applies to walls, and elements that support walls, that contain doors or windows required for emergency egress.
(3)	[F20-OS2.1,OS2.5] [F22-OS2.5] [F20,F22-OS2.3] Applies to elements that support or are part of an environmental separator.

	<p>[F20-OP2.1,OP2.5] [F22-OP2.4,OP2.5] [F20,F22-OP2.3] Applies to elements that support or are part of an environmental separator.</p>
	<p>[F20,F22-OH1.1,OH1.2,OH1.3] Applies to elements that support or are part of an environmental separator.</p>
	<p>[F22-OH4]</p>
	<p>[F20,F22-OS1.2] Applies to assemblies required to provide fire resistance.</p>
	<p>[F22-OS3.1] [F22-OS3.7] Applies to walls, and elements that support walls, that contain doors or windows required for emergency egress.</p>
(4)	<p>[F20-OS2.1,OS2.5] [F22-OS2.5] [F20,F22-OS2.3] Applies to elements that support or are part of an environmental separator.</p>
	<p>[F20-OP2.1,OP2.5] [F22-OP2.4,OP2.5] [F20,F22-OP2.3] Applies to elements that support or are part of an environmental separator.</p>
	<p>[F20,F22-OH1.1,OH1.2,OH1.3] Applies to elements that support or are part of an environmental separator.</p>
	<p>[F22-OH4]</p>
	<p>[F20,F22-OS1.2] Applies to assemblies required to provide fire resistance.</p>
	<p>[F22-OS3.1] [F22-OS3.7] Applies to walls, and elements that support walls, that contain doors or windows required for emergency egress.</p>
(5)	<p>[F20-OS2.1,OS2.5] [F22-OS2.5] [F20,F22-OS2.3] Applies to elements that support or are part of an environmental separator.</p>
	<p>[F20-OP2.1,OP2.5] [F22-OP2.4,OP2.5] [F20,F22-OP2.3] Applies to elements that support or are part of an environmental separator.</p>
	<p>[F20,F22-OH1.1,OH1.2,OH1.3] Applies to elements that support or are part of an environmental separator.</p>
	<p>[F22-OH4]</p>
	<p>[F20,F22-OS1.2] Applies to assemblies required to provide fire resistance.</p>
	<p>[F22-OS3.1] [F22-OS3.7] Applies to walls, and elements that support walls, that contain doors or windows required for emergency egress.</p>
<b>9.23.9.3. Restraint of Joist Bottoms</b>	
(1)	<p>[F20-OS2.1,OS2.5] [F22-OS2.5] [F20,F22-OS2.3] Applies to elements that support or are part of an environmental separator.</p>
	<p>[F20-OP2.1,OP2.5] [F22-OP2.4,OP2.5] [F20,F22-OP2.3] Applies to elements that support or are part of an environmental separator.</p>
	<p>[F20,F22-OH1.1,OH1.2,OH1.3] Applies to elements that support or are part of an environmental separator.</p>
	<p>[F22-OH4]</p>
	<p>[F20,F22-OS1.2] Applies to assemblies required to provide fire resistance.</p>

	[F22-OS3.1] [F22-OS3.7] Applies to walls, and elements that support walls, that contain doors or windows required for emergency egress.
<b>9.23.9.4. Strapping, Bridging, Furring and Ceilings in Span Tables 9.23.4.2.-A and -B</b>	
(1)	[F20-OS2.1,OS2.5] [F22-OS2.5] [F20,F22-OS2.3] Applies to elements that support or are part of an environmental separator.
	[F20-OP2.1,OP2.5] [F22-OP2.4,OP2.5] [F20,F22-OP2.3] Applies to elements that support or are part of an environmental separator.
	[F20,F22-OH1.1,OH1.2,OH1.3] Applies to elements that support or are part of an environmental separator.
	[F22-OH4]
	[F20,F22-OS1.2] Applies to assemblies required to provide fire resistance.
	[F22-OS3.1] [F22-OS3.7] Applies to walls, and elements that support walls, that contain doors or windows required for emergency egress.
(2)	[F20-OS2.1,OS2.5] [F22-OS2.5] [F20,F22-OS2.3] Applies to elements that support or are part of an environmental separator.
	[F20-OP2.1,OP2.5] [F22-OP2.4,OP2.5] [F20,F22-OP2.3] Applies to elements that support or are part of an environmental separator.
	[F20,F22-OH1.1,OH1.2,OH1.3] Applies to elements that support or are part of an environmental separator.
	[F22-OH4]
	[F20,F22-OS1.2] Applies to assemblies required to provide fire resistance.
	[F22-OS3.1] [F22-OS3.7] Applies to walls, and elements that support walls, that contain doors or windows required for emergency egress.
(3)	[F20-OS2.1,OS2.5] [F22-OS2.5] [F20,F22-OS2.3] Applies to elements that support or are part of an environmental separator.
	[F20-OP2.1,OP2.5] [F22-OP2.4,OP2.5] [F20,F22-OP2.3] Applies to elements that support or are part of an environmental separator.
	[F20,F22-OH1.1,OH1.2,OH1.3] Applies to elements that support or are part of an environmental separator.
	[F22-OH4]
	[F20,F22-OS1.2] Applies to assemblies required to provide fire resistance.
	[F22-OS3.1] [F22-OS3.7] Applies to walls, and elements that support walls, that contain doors or windows required for emergency egress.
(4)	[F20-OS2.1,OS2.5] [F22-OS2.5] [F20,F22-OS2.3] Applies to elements that support or are part of an environmental separator.

	<p>[F20-OP2.1,OP2.5] [F22-OP2.4,OP2.5] [F20,F22-OP2.3] Applies to elements that support or are part of an environmental separator.</p>
	<p>[F20,F22-OH1.1,OH1.2,OH1.3] Applies to elements that support or are part of an environmental separator.</p>
	<p>[F22-OH4]</p>
	<p>[F20,F22-OS1.2] Applies to assemblies required to provide fire resistance.</p>
	<p>[F22-OS3.1] [F22-OS3.7] Applies to walls, and elements that support walls, that contain doors or windows required for emergency egress.</p>
(5)	<p>[F20-OS2.1,OS2.5] [F22-OS2.5] [F20,F22-OS2.3] Applies to elements that support or are part of an environmental separator.</p>
	<p>[F20-OP2.1,OP2.5] [F22-OP2.4,OP2.5] [F20,F22-OP2.3] Applies to elements that support or are part of an environmental separator.</p>
	<p>[F20,F22-OH1.1,OH1.2,OH1.3] Applies to elements that support or are part of an environmental separator.</p>
	<p>[F22-OH4]</p>
	<p>[F20,F22-OS1.2] Applies to assemblies required to provide fire resistance.</p>
	<p>[F22-OS3.1] [F22-OS3.7] Applies to walls, and elements that support walls, that contain doors or windows required for emergency egress.</p>
(6)	<p>[F20-OS2.1,OS2.5] [F22-OS2.5] [F20,F22-OS2.3] Applies to elements that support or are part of an environmental separator.</p>
	<p>[F20-OP2.1,OP2.5] [F22-OP2.4,OP2.5] [F20,F22-OP2.3] Applies to elements that support or are part of an environmental separator.</p>
	<p>[F20,F22-OH1.1,OH1.2,OH1.3] Applies to elements that support or are part of an environmental separator.</p>
	<p>[F22-OH4]</p>
	<p>[F20,F22-OS1.2] Applies to assemblies required to provide fire resistance.</p>
	<p>[F22-OS3.1] [F22-OS3.7] Applies to walls, and elements that support walls, that contain doors or windows required for emergency egress.</p>
<b>9.23.9.5. Header Joists</b>	
(1)	<p>[F20-OS2.1,OS2.5] [F22-OS2.5] [F20,F22-OS2.3] Applies to elements that support or are part of an environmental separator.</p>
	<p>[F20-OP2.1,OP2.5] [F22-OP2.4,OP2.5] [F20,F22-OP2.3] Applies to elements that support or are part of an environmental separator.</p>
	<p>[F20,F22-OH1.1,OH1.2,OH1.3] Applies to elements that support or are part of an environmental separator.</p>
	<p>[F22-OH4]</p>
	<p>[F20,F22-OS1.2] Applies to assemblies required to provide fire resistance.</p>

	[F22-OS3.1] [F22-OS3.7] Applies to walls, and elements that support walls, that contain doors or windows required for emergency egress.
<b>9.23.9.6. Trimmer Joists</b>	
(1)	[F20-OS2.1,OS2.5] [F22-OS2.5] [F20,F22-OS2.3] Applies to elements that support or are part of an environmental separator.
	[F20-OP2.1,OP2.5] [F22-OP2.4,OP2.5] [F20,F22-OP2.3] Applies to elements that support or are part of an environmental separator.
	[F20,F22-OH1.1,OH1.2,OH1.3] Applies to elements that support or are part of an environmental separator.
	[F22-OH4]
	[F20,F22-OS1.2] Applies to assemblies required to provide fire resistance.
	[F22-OS3.1] [F22-OS3.7] Applies to walls, and elements that support walls, that contain doors or windows required for emergency egress.
<b>9.23.9.7. Support of Tail and Header Joists</b>	
(1)	[F20-OS2.1,OS2.5] [F22-OS2.5] [F20,F22-OS2.3] Applies to elements that support or are part of an environmental separator.
	[F20-OP2.1,OP2.5] [F22-OP2.4,OP2.5] [F20,F22-OP2.3] Applies to elements that support or are part of an environmental separator.
	[F20,F22-OH1.1,OH1.2,OH1.3] Applies to elements that support or are part of an environmental separator.
	[F22-OH4]
	[F20,F22-OS1.2] Applies to assemblies required to provide fire resistance.
	[F22-OS3.1] [F22-OS3.7] Applies to walls, and elements that support walls, that contain doors or windows required for emergency egress.
<b>9.23.9.8. Support of Walls</b>	
(1)	[F20-OS2.1,OS2.5] [F22-OS2.5] [F20,F22-OS2.3] Applies to elements that support or are part of an environmental separator.
	[F20-OP2.1,OP2.5] [F22-OP2.4,OP2.5] [F20,F22-OP2.3] Applies to elements that support or are part of an environmental separator.
	[F20,F22-OH1.1,OH1.2,OH1.3] Applies to elements that support or are part of an environmental separator.
	[F22-OH4]
	[F20,F22-OS1.2] Applies to assemblies required to provide fire resistance.
	[F22-OS3.1] [F22-OS3.7] Applies to walls, and elements that support walls, that contain doors or windows required for emergency egress.

(2)	[F20-OS2.1,OS2.5] [F22-OS2.5] [F20,F22-OS2.3] Applies to elements that support or are part of an environmental separator.
	[F20-OP2.1,OP2.5] [F22-OP2.4,OP2.5] [F20,F22-OP2.3] Applies to elements that support or are part of an environmental separator.
	[F20,F22-OH1.1,OH1.2,OH1.3] Applies to elements that support or are part of an environmental separator.
	[F22-OH4]
	[F20,F22-OS1.2] Applies to assemblies required to provide fire resistance.
	[F22-OS3.1] [F22-OS3.7] Applies to walls, and elements that support walls, that contain doors or windows required for emergency egress.
(4)	[F22-OS3.1] [F22-OS3.7] Applies to walls, and elements that support walls, that contain doors or windows required for emergency egress.
	[F20,F22-OS1.2] Applies to assemblies required to provide fire resistance.
	[F20-OP2.1,OP2.5] [F22-OP2.4,OP2.5] [F20,F22-OP2.3] Applies to elements that support or are part of an environmental separator.
	[F22-OH4]
	[F20-OS2.1,OS2.5] [F22-OS2.5] [F20,F22-OS2.3] Applies to elements that support or are part of an environmental separator.
	[F20,F22-OH1.1,OH1.2,OH1.3] Applies to elements that support or are part of an environmental separator.
(5)	[F20-OS2.1,OS2.5] [F22-OS2.5] [F20,F22-OS2.3] Applies to elements that support or are part of an environmental separator.
	[F20-OP2.1,OP2.5] [F22-OP2.4,OP2.5] [F20,F22-OP2.3] Applies to elements that support or are part of an environmental separator.
	[F20,F22-OH1.1,OH1.2,OH1.3] Applies to elements that support or are part of an environmental separator.
	[F22-OH4]
	[F20,F22-OS1.2] Applies to assemblies required to provide fire resistance.
	[F22-OS3.1] [F22-OS3.7] Applies to walls, and elements that support walls, that contain doors or windows required for emergency egress.
(6)	[F22-OS3.1] [F22-OS3.7] Applies to walls, and elements that support walls, that contain doors or windows required for emergency egress.
	[F20,F22-OS1.2] Applies to assemblies required to provide fire resistance.
	[F20-OP2.1,OP2.5] [F22-OP2.4,OP2.5] [F20,F22-OP2.3] Applies to elements that support or are part of an environmental separator.
	[F22-OH4]



	[F20-OS2.1,OS2.5] [F22-OS2.5] [F20,F22-OS2.3] Applies to elements that support or are part of an environmental separator.
	[F20,F22-OH1.1,OH1.2,OH1.3] Applies to elements that support or are part of an environmental separator.
<b>9.23.9.9. Cantilevered Floor Joists</b>	
(1)	[F20-OS2.1,OS2.5] [F22-OS2.5] [F20,F22-OS2.3] Applies to elements that support or are part of an environmental separator.
	[F20-OP2.1,OP2.5] [F22-OP2.4,OP2.5] [F20,F22-OP2.3] Applies to elements that support or are part of an environmental separator.
	[F20,F22-OH1.1,OH1.2,OH1.3] Applies to elements that support or are part of an environmental separator.
	[F22-OH4]
	[F20,F22-OS1.2] Applies to assemblies required to provide fire resistance.
	[F22-OS3.1] [F22-OS3.7] Applies to walls, and elements that support walls, that contain doors or windows required for emergency egress.
(2)	[F20-OS2.1,OS2.5] [F22-OS2.5] [F20,F22-OS2.3] Applies to elements that support or are part of an environmental separator.
	[F20-OP2.1,OP2.5] [F22-OP2.4,OP2.5] [F20,F22-OP2.3] Applies to elements that support or are part of an environmental separator.
	[F20,F22-OH1.1,OH1.2,OH1.3] Applies to elements that support or are part of an environmental separator.
	[F22-OH4]
	[F20,F22-OS1.2] Applies to assemblies required to provide fire resistance.
	[F22-OS3.1] [F22-OS3.7] Applies to walls, and elements that support walls, that contain doors or windows required for emergency egress.
(3)	[F20-OS2.1,OS2.5] [F22-OS2.5] [F20,F22-OS2.3] Applies to elements that support or are part of an environmental separator.
	[F20-OP2.1,OP2.5] [F22-OP2.4,OP2.5] [F20,F22-OP2.3] Applies to elements that support or are part of an environmental separator.
	[F20,F22-OH1.1,OH1.2,OH1.3] Applies to elements that support or are part of an environmental separator.
	[F22-OH4]
	[F20,F22-OS1.2] Applies to assemblies required to provide fire resistance.
	[F22-OS3.1] [F22-OS3.7] Applies to walls, and elements that support walls, that contain doors or windows required for emergency egress.
<b>9.23.10.1. Stud Size and Spacing</b>	

(1)	[F20-OS2.1,OS2.5] [F22-OS2.5] [F20,F22-OS2.3] Applies to elements that support or are part of an environmental separator.
	[F20-OP2.1,OP2.5] [F22-OP2.4,OP2.5] [F20,F22-OP2.3] Applies to elements that support or are part of an environmental separator.
	[F20,F22-OH1.1,OH1.2,OH1.3] Applies to elements that support or are part of an environmental separator.
	[F22-OH4] Applies to floors and elements that support floors.
	[F20,F22-OS1.2] Applies to assemblies required to provide fire resistance.
	[F22-OS3.1] Applies to floors and elements that support floors. [F22-OS3.7] Applies to walls, and elements that support walls, that contain doors or windows required for emergency egress.
<b>9.23.10.2. Bracing and Lateral Support</b>	
(1)	[F20-OS2.1,OS2.5] [F22-OS2.5] [F20,F22-OS2.3] Applies to walls that support or are part of an environmental separator.
	[F20-OP2.1,OP2.5] [F22-OP2.4,OP2.5] [F20,F22-OP2.3] Applies to walls that support or are part of an environmental separator.
	[F20,F22-OH1.1,OH1.2,OH1.3] Applies to walls that support or are part of an environmental separator.
	[F22-OH4] Applies to walls that support floors.
	[F20,F22-OS1.2] Applies to assemblies required to provide fire resistance.
	[F22-OS3.1] Applies to walls that support floors. [F22-OS3.7] Applies to walls that contain doors or windows required for emergency egress.
<b>9.23.10.3. Orientation of Studs</b>	
(1)	[F20-OS2.1,OS2.5] [F22-OS2.5] [F20,F22-OS2.3] Applies to elements that support or are part of an environmental separator.
	[F20-OP2.1,OP2.5] [F22-OP2.4,OP2.5] [F20,F22-OP2.3] Applies to elements that support or are part of an environmental separator.
	[F20,F22-OH1.1,OH1.2,OH1.3] Applies to elements that support or are part of an environmental separator.
	[F22-OH4] Applies to floors and elements that support floors.
	[F20,F22-OS1.2] Applies to assemblies required to provide fire resistance.
	[F22-OS3.1] Applies to floors and elements that support floors. [F22-OS3.7] Applies to walls, and elements that support walls, that contain doors or windows required for emergency egress.
(3)	[F20-OS2.1,OS2.5] [F22-OS2.5] [F20,F22-OS2.3] Applies to elements that support or are part of an environmental separator.
	[F20,F22-OH1.1,OH1.2,OH1.3] Applies to elements that support or are part of an environmental separator.
	[F20-OP2.1,OP2.5] [F22-OP2.4,OP2.5] [F20,F22-OP2.3] Applies to elements that support or are part of an environmental separator.

	[F20,F22-OS1.2] Applies to assemblies required to provide fire resistance.
	[F22-OS3.1] Applies to floors and elements that support floors. [F22-OS3.7] Applies to walls, and elements that support walls, that contain doors or windows required for emergency egress.
<b>9.23.10.4. Continuity of Studs</b>	
(1)	[F20-OS2.1,OS2.5] [F22-OS2.5] [F20,F22-OS2.3] Applies to elements that support or are part of an environmental separator.
	[F20-OP2.1,OP2.5] [F22-OP2.4,OP2.5] [F20,F22-OP2.3] Applies to elements that support or are part of an environmental separator.
	[F20,F22-OH1.1,OH1.2,OH1.3] Applies to elements that support or are part of an environmental separator.
	[F22-OH4] Applies to floors and elements that support floors.
	[F20,F22-OS1.2] Applies to assemblies required to provide fire resistance.
	[F22-OS3.1] Applies to floors and elements that support floors. [F22-OS3.7] Applies to walls, and elements that support walls, that contain doors or windows required for emergency egress.
<b>9.23.10.5. Support for Cladding, Sheathing and Finishing Materials</b>	
(1)	[F20-OS2.1,OS2.5] [F22-OS2.5] [F20,F22-OS2.3] Applies to elements that support or are part of an environmental separator.
	[F20-OP2.1,OP2.5] [F22-OP2.4,OP2.5] [F20,F22-OP2.3] Applies to elements that support or are part of an environmental separator.
	[F20,F22-OH1.1,OH1.2,OH1.3] Applies to elements that support or are part of an environmental separator.
	[F22-OH4] Applies to floors and elements that support floors.
	[F20,F22-OS1.2] Applies to assemblies required to provide fire resistance.
	[F22-OS3.1] Applies to floors and elements that support floors. [F22-OS3.7] Applies to walls, and elements that support walls, that contain doors or windows required for emergency egress.
(2)	[F20-OS2.1,OS2.5] [F22-OS2.5] [F20,F22-OS2.3] Applies to elements that support or are part of an environmental separator.
	[F20-OP2.1,OP2.5] [F22-OP2.4,OP2.5] [F20,F22-OP2.3] Applies to elements that support or are part of an environmental separator.
	[F20,F22-OH1.1,OH1.2,OH1.3] Applies to elements that support or are part of an environmental separator.
	[F22-OS3.1] Applies to floors and elements that support floors. [F22-OS3.7] Applies to walls, and elements that support walls, that contain doors or windows required for emergency egress.
	[F20,F22-OS1.2] Applies to assemblies required to provide fire resistance.
	[F22-OH4] Applies to floors and elements that support floors.
<b>9.23.10.6. Studs at Sides of Openings</b>	

(1)	[F20-OS2.1,OS2.5] [F22-OS2.5] [F20,F22-OS2.3] Applies to elements that support or are part of an environmental separator.
	[F20-OP2.1,OP2.5] [F22-OP2.4,OP2.5] [F20,F22-OP2.3] Applies to elements that support or are part of an environmental separator.
	[F20,F22-OH1.1,OH1.2,OH1.3] Applies to elements that support or are part of an environmental separator.
	[F20,F22-OH4] Applies to floors and elements that support floors.
	[F20,F22-OS3.1] Applies to floors and elements that support floors. [F20,F22-OS3.7] Applies to walls, and elements that support walls, that contain doors or windows required for emergency egress.
	[F20,F22-OS1.2] Applies to assemblies required to provide fire resistance.
(2)	[F20-OS2.1,OS2.5] [F22-OS2.5] [F20,F22-OS2.3] Applies to elements that support or are part of an environmental separator.
	[F20-OP2.1,OP2.5] [F22-OP2.4,OP2.5] [F20,F22-OP2.3] Applies to elements that support or are part of an environmental separator.
	[F20,F22-OH1.1,OH1.2,OH1.3] Applies to elements that support or are part of an environmental separator.
	[F20,F22-OH4] Applies to floors and elements that support floors.
	[F20,F22-OS3.1] Applies to floors and elements that support floors. [F20,F22-OS3.7] Applies to walls, and elements that support walls, that contain doors or windows required for emergency egress.
	[F20,F22-OS1.2] Applies to assemblies required to provide fire resistance.
(3)	[F20-OS2.1] (b) [F20,F22-OS2.5] (b) [F20,F22-OS2.3] Applies to elements that support or are part of an environmental separator.
	[F20-OP2.1] (b) [F20-OP2.5] (b) [F22-OP2.4,OP2.5] (b) [F20,F22-OP2.3] Applies to elements that support or are part of an environmental separator.
	(b) [F20,F22-OH1.1,OH1.2,OH1.3] Applies to elements that support or are part of an environmental separator.
	(b) [F20,F22-OH4] Applies to floors and elements that support floors.
	(b) [F20,F22-OS3.1] Applies to floors and elements that support floors. (b) [F20,F22-OS3.7] Applies to walls, and elements that support walls, that contain doors or windows required for emergency egress.
	(b) [F20,F22-OS1.2] Applies to assemblies required to provide fire resistance.
	<b>9.23.11.1. Size of Wall Plates</b>
(1)	[F20-OS2.1,OS2.5] [F22-OS2.5] [F20,F22-OS2.3] Applies to elements that support or are part of an environmental separator.
	[F20-OP2.1,OP2.5] [F22-OP2.4,OP2.5] [F20,F22-OP2.3] Applies to elements that support or are part of an environmental separator.

	[F20,F22-OH1.1,OH1.2,OH1.3] Applies to elements that support or are part of an environmental separator.
	[F22-OS3.1] Applies to floors and elements that support floors. [F22-OS3.7] Applies to walls, and elements that support walls, that contain doors or windows required for emergency egress.
	[F22-OH4] Applies to floors and elements that support floors.
	[F20,F22-OS1.2] Applies to assemblies required to provide fire resistance.
(2)	[F22-OS3.1] Applies to floors and elements that support floors. [F22-OS3.7] Applies to walls, and elements that support walls, that contain doors or windows required for emergency egress.
	[F20,F22-OS1.2] Applies to assemblies required to provide fire resistance.
	[F20-OP2.1,OP2.5] [F22-OP2.4,OP2.5] [F20,F22-OP2.3] Applies to elements that support or are part of an environmental separator.
	[F22-OH4] Applies to floors and elements that support floors.
	[F20,F22-OH1.1,OH1.2,OH1.3] Applies to elements that support or are part of an environmental separator.
	[F20-OS2.1,OS2.5] [F22-OS2.5] [F20,F22-OS2.3] Applies to elements that support or are part of an environmental separator.
<b>9.23.11.2. Bottom Wall Plates</b>	
(1)	[F20-OS2.1,OS2.5] [F22-OS2.5] [F20,F22-OS2.3] Applies to elements that support or are part of an environmental separator.
	[F20-OP2.1,OP2.5] [F22-OP2.4,OP2.5] [F20,F22-OP2.3] Applies to elements that support or are part of an environmental separator.
	[F20,F22-OH1.1,OH1.2,OH1.3] Applies to elements that support or are part of an environmental separator.
	[F22-OH4] Applies to floors and elements that support floors.
	[F20,F22-OS1.2] Applies to assemblies required to provide fire resistance.
	[F22-OS3.1] Applies to floors and elements that support floors. [F22-OS3.7] Applies to walls, and elements that support walls, that contain doors or windows required for emergency egress.
(2)	[F20-OS2.1,OS2.3,OS2.5] [F22-OS2.3,OS2.5]
	[F20-OP2.1,OP2.3,OP2.5] [F22-OP2.3,OP2.4,OP2.5]
	[F20,F22-OH1.1,OH1.2,OH1.3]
	[F22-OH4] Applies to floors and elements that support floors.
	[F20,F22-OS1.2] Applies to assemblies required to provide fire resistance.
	[F22-OS3.1] Applies to floors and elements that support floors. [F22-OS3.7] Applies to walls, and elements that support walls, that contain doors or windows required for emergency egress.
<b>9.23.11.3. Top Plates</b>	

(1)	[F20-OS2.1,OS2.5] [F22-OS2.5] [F20,F22-OS2.3] Applies to elements that support or are part of an environmental separator.
	[F20-OP2.1,OP2.5] [F22-OP2.4,OP2.5] [F20,F22-OP2.3] Applies to elements that support or are part of an environmental separator.
	[F20,F22-OH1.1,OH1.2,OH1.3] Applies to elements that support or are part of an environmental separator.
	[F22-OH4] Applies to floors and elements that support floors.
	[F20,F22-OS1.2] Applies to assemblies required to provide fire resistance.
	[F22-OS3.1] Applies to floors and elements that support floors. [F22-OS3.7] Applies to walls, and elements that support walls, that contain doors or windows required for emergency egress.
(2)	[F20-OS2.1,OS2.5] [F22-OS2.5] [F20,F22-OS2.3] Applies to elements that support or are part of an environmental separator.
	[F20-OP2.1,OP2.5] [F22-OP2.4,OP2.5] [F20,F22-OP2.3] Applies to elements that support or are part of an environmental separator.
	[F20,F22-OH1.1,OH1.2,OH1.3] Applies to elements that support or are part of an environmental separator.
	[F22-OH4] Applies to floors and elements that support floors.
	[F20,F22-OS1.2] Applies to assemblies required to provide fire resistance.
	[F22-OS3.1] Applies to floors and elements that support floors. [F22-OS3.7] Applies to walls, and elements that support walls, that contain doors or windows required for emergency egress.
(3)	[F20-OS2.1,OS2.5] [F22-OS2.5] [F20,F22-OS2.3] Applies to elements that support or are part of an environmental separator.
	[F20-OP2.1,OP2.5] [F22-OP2.4,OP2.5] [F20,F22-OP2.3] Applies to elements that support or are part of an environmental separator.
	[F20,F22-OH1.1,OH1.2,OH1.3] Applies to elements that support or are part of an environmental separator.
	[F20,F22-OS1.2] Applies to assemblies required to provide fire resistance.
	[F22-OH4] Applies to floors and elements that support floors.
	[F22-OS3.1] Applies to floors and elements that support floors. [F22-OS3.7] Applies to walls, and elements that support walls, that contain doors or windows required for emergency egress.
(4)	[F20-OS2.1,OS2.5] [F22-OS2.5] [F20,F22-OS2.3] Applies to elements that support or are part of an environmental separator.
	[F20-OP2.1,OP2.5] [F22-OP2.4,OP2.5] [F20,F22-OP2.3] Applies to elements that support or are part of an environmental separator.
	[F20,F22-OH1.1,OH1.2,OH1.3] Applies to elements that support or are part of an environmental separator.

	[F22-OH4] Applies to floors and elements that support floors.
	[F20,F22-OS1.2] Applies to assemblies required to provide fire resistance.
	[F22-OS3.1] Applies to floors and elements that support floors. [F22-OS3.7] Applies to walls, and elements that support walls, that contain doors or windows required for emergency egress.
<b>9.23.11.4. Joints in Top Plates</b>	
(1)	[F20-OS2.1,OS2.5] [F22-OS2.5] [F20,F22-OS2.3] Applies to elements that support or are part of an environmental separator.
	[F20-OP2.1,OP2.5] [F22-OP2.4,OP2.5] [F20,F22-OP2.3] Applies to elements that support or are part of an environmental separator.
	[F20,F22-OH1.1,OH1.2,OH1.3] Applies to elements that support or are part of an environmental separator.
	[F22-OH4] Applies to floors and elements that support floors.
	[F22-OS1.2] Applies to assemblies required to provide fire resistance.
	[F22-OS3.1] Applies to floors and elements that support floors. [F22-OS3.7] Applies to walls, and elements that support walls, that contain doors or windows required for emergency egress.
(2)	[F20-OS2.1,OS2.5] [F22-OS2.5] [F20,F22-OS2.3] Applies to elements that support or are part of an environmental separator.
	[F20-OP2.1,OP2.5] [F22-OP2.4,OP2.5] [F20,F22-OP2.3] Applies to elements that support or are part of an environmental separator.
	[F20,F22-OH1.1,OH1.2,OH1.3] Applies to elements that support or are part of an environmental separator.
	[F22-OH4] Applies to floors and elements that support floors.
	[F20,F22-OS1.2] Applies to assemblies required to provide fire resistance.
	[F22-OS3.1] Applies to floors and elements that support floors. [F22-OS3.7] Applies to walls, and elements that support walls, that contain doors or windows required for emergency egress.
(3)	[F20-OS2.1,OS2.5] [F22-OS2.5] [F20,F22-OS2.3] Applies to elements that support or are part of an environmental separator.
	[F20-OP2.1,OP2.5] [F22-OP2.4,OP2.5] [F20,F22-OP2.3] Applies to elements that support or are part of an environmental separator.
	[F20,F22-OH1.1,OH1.2,OH1.3] Applies to elements that support or are part of an environmental separator.
	[F22-OH4] Applies to floors and elements that support floors.
	[F20,F22-OS1.2] Applies to assemblies required to provide fire resistance.
	[F22-OS3.1] Applies to floors and elements that support floors. [F22-OS3.7] Applies to walls, and elements that support walls, that contain doors or windows required for emergency egress.

(4)	[F20-OS2.1,OS2.5] [F22-OS2.5] [F20,F22-OS2.3] Applies to elements that support or are part of an environmental separator.
	[F20-OP2.1,OP2.5] [F22-OP2.4,OP2.5] [F20,F22-OP2.3] Applies to elements that support or are part of an environmental separator.
	[F20,F22-OH1.1,OH1.2,OH1.3] Applies to elements that support or are part of an environmental separator.
	[F22-OH4] Applies to floors and elements that support floors.
	[F20,F22-OS1.2] Applies to assemblies required to provide fire resistance.
	[F22-OS3.1] Applies to floors and elements that support floors. [F22-OS3.7] Applies to walls, and elements that support walls, that contain doors or windows required for emergency egress.
(5)	[F20-OS2.1,OS2.5] [F22-OS2.5] [F20,F22-OS2.3] Applies to elements that support or are part of an environmental separator.
	[F20-OP2.1,OP2.5] [F22-OP2.4,OP2.5] [F20,F22-OP2.3] Applies to elements that support or are part of an environmental separator.
	[F20,F22-OH1.1,OH1.2,OH1.3] Applies to elements that support or are part of an environmental separator.
	[F22-OH4] Applies to floors and elements that support floors.
	[F20,F22-OS1.2] Applies to assemblies required to provide fire resistance.
	[F22-OS3.1] Applies to floors and elements that support floors. [F22-OS3.7] Applies to walls, and elements that support walls, that contain doors or windows required for emergency egress.
<b>9.23.12.1. Openings in Non-Loadbearing Walls</b>	
(1)	[F20-OS2.1,OS2.5] [F22-OS2.5] [F20,F22-OS2.3] Applies to elements that support or are part of an environmental separator.
	[F20-OP2.1,OP2.5] [F22-OP2.4,OP2.5] [F20,F22-OP2.3] Applies to elements that support or are part of an environmental separator.
	[F20,F22-OH1.1,OH1.2,OH1.3] Applies to elements that support or are part of an environmental separator.
	[F22-OS3.1] Applies to floors and elements that support floors. [F22-OS3.7] Applies to walls, and elements that support walls, that contain doors or windows required for emergency egress.
(2)	[F20,F22-OS1.2]
<b>9.23.12.2. Openings in Loadbearing Walls</b>	
(1)	[F20-OS2.1,OS2.5] [F22-OS2.5] [F20,F22-OS2.3] Applies to elements that support or are part of an environmental separator.
	[F20-OP2.1,OP2.5] [F22-OP2.4,OP2.5] [F20,F22-OP2.3] Applies to elements that support or are part of an environmental separator.



	[F20,F22-OH1.1,OH1.2,OH1.3] Applies to elements that support or are part of an environmental separator.
	[F22-OH4] Applies to floors and elements that support floors.
	[F20,F22-OS1.2] Applies to assemblies required to provide fire resistance.
	[F22-OS3.1] Applies to floors and elements that support floors. [F22-OS3.7] Applies to walls, and elements that support walls, that contain doors or windows required for emergency egress.
(2)	[F20-OS2.1,OS2.5] [F22-OS2.5] [F20,F22-OS2.3] Applies to elements that support or are part of an environmental separator.
	[F20-OP2.1,OP2.5] [F22-OP2.4,OP2.5] [F20,F22-OP2.3] Applies to elements that support or are part of an environmental separator.
	[F20,F22-OH1.1,OH1.2,OH1.3] Applies to elements that support or are part of an environmental separator.
	[F22-OH4] Applies to floors and elements that support floors.
	[F20,F22-OS1.2] Applies to assemblies required to provide fire resistance.
	[F22-OS3.1] Applies to floors and elements that support floors. [F22-OS3.7] Applies to walls, and elements that support walls, that contain doors or windows required for emergency egress.
<b>9.23.12.3. Lintel Spans and Sizes</b>	
(1)	[F20-OS2.1,OS2.5] [F22-OS2.5] [F20,F22-OS2.3] Applies to elements that support or are part of an environmental separator.
	[F20-OP2.1,OP2.5] [F22-OP2.4,OP2.5] [F20,F22-OP2.3] Applies to elements that support or are part of an environmental separator.
	[F20,F22-OH1.1,OH1.2,OH1.3] Applies to elements that support or are part of an environmental separator.
	[F22-OH4] Applies to floors and elements that support floors.
	[F20,F22-OS1.2] Applies to assemblies required to provide fire resistance.
	[F22-OS3.1] Applies to floors and elements that support floors. [F22-OS3.7] Applies to walls, and elements that support walls, that contain doors or windows required for emergency egress.
(2)	[F20-OS2.1,OS2.5] [F22-OS2.5] [F20,F22-OS2.3] Applies to elements that support or are part of an environmental separator.
	[F20-OP2.1,OP2.5] [F22-OP2.4,OP2.5] [F20,F22-OP2.3] Applies to elements that support or are part of an environmental separator.
	[F20,F22-OH1.1,OH1.2,OH1.3] Applies to elements that support or are part of an environmental separator.
	[F22-OH4] Applies to floors and elements that support floors.
	[F20,F22-OS1.2] Applies to assemblies required to provide fire resistance.
	[F22-OS3.1] Applies to floors and elements that support floors. [F22-OS3.7] Applies to walls, and elements that support walls, that contain doors or windows required for emergency egress.

(3)	[F20-OS2.1,OS2.5] [F22-OS2.5] [F20,F22-OS2.3] Applies to elements that support or are part of an environmental separator.
	[F20-OP2.1,OP2.5] [F22-OP2.4,OP2.5] [F20,F22-OP2.3] Applies to elements that support or are part of an environmental separator.
	[F20,F22-OH1.1,OH1.2,OH1.3] Applies to elements that support or are part of an environmental separator.
	[F22-OH4] Applies to floors and elements that support floors.
	[F20,F22-OS1.2] Applies to assemblies required to provide fire resistance.
	[F22-OS3.1] Applies to floors and elements that support floors. [F22-OS3.7] Applies to walls, and elements that support walls, that contain doors or windows required for emergency egress.
<b>9.23.13.1. Requirements for Low to Moderate Wind and Seismic Forces</b>	
(2)	[F20-OS2.1,OS2.3,OS2.5] [F22-OS2.3,OS2.4,OS2.5]
	[F20-OP2.1,OP2.3,OP2.5] [F22-OP2.3,OP2.4,OP2.5]
	[F20,F22-OH1.1,OH1.2,OH1.3]
	[F20,F22-OS1.2] Applies to assemblies required to provide fire resistance.
	[F22-OS3.1] Applies to walls that support floors. [F22-OS3.7] Applies to walls that contain doors or windows required for emergency egress.
	[F20,F22-OH4] Applies to walls that support floors.
<b>9.23.13.4. Braced Wall Bands</b>	
(1)	[F20-OS2.1,OS2.3,OS2.5] [F22-OS2.3,OS2.4,OS2.5]
	[F20-OP2.1,OP2.3,OP2.5] [F22-OP2.3,OP2.4,OP2.5]
	[F20,F22-OS1.2] Applies to assemblies required to provide fire resistance.
	[F22-OS3.1] Applies to walls that support floors. [F22-OS3.7] Applies to walls that contain doors or windows required for emergency egress.
	[F20,F22-OH4] Applies to walls that support floors.
	[F20,F22-OH1.1,OH1.2,OH1.3] Applies to elements that support or are part of an environmental separator.
(2)	[F20-OS2.1,OS2.3,OS2.5] [F22-OS2.3,OS2.4,OS2.5]
	[F20-OP2.1,OP2.3,OP2.5] [F22-OP2.3,OP2.4,OP2.5]
	[F20,F22-OH1.1,OH1.2,OH1.3]
	[F20,F22-OS1.2] Applies to assemblies required to provide fire resistance.
	[F22-OS3.1] Applies to walls that support floors. [F22-OS3.7] Applies to walls that contain doors or windows required for emergency egress.
	[F20,F22-OH4] Applies to walls that support floors.
(3)	[F20-OS2.1,OS2.3,OS2.5] [F22-OS2.3,OS2.4,OS2.5]
	[F20-OP2.1,OP2.3,OP2.5] [F22-OP2.3,OP2.4,OP2.5]
	[F20,F22-OS1.2] Applies to assemblies required to provide fire resistance.
	[F22-OS3.1] Applies to walls that support floors. [F22-OS3.7] Applies to walls that contain doors or windows required for emergency egress.

	[F20,F22-OH4] Applies to walls that support floors.
	[F20,F22-OH1.1,OH1.2,OH1.3] Applies to elements that support or are part of an environmental separator.
<b>9.23.13.5. Braced Wall Panels in Braced Wall Bands</b>	
(1)	[F20-OS2.1,OS2.3,OS2.5] [F22-OS2.3,OS2.4,OS2.5]
	[F20-OP2.1,OP2.3,OP2.5] [F22-OP2.3,OP2.4,OP2.5]
	[F20,F22-OS1.2] Applies to assemblies required to provide fire resistance.
	[F22-OS3.1] Applies to walls that support floors. [F22-OS3.7] Applies to walls that contain doors or windows required for emergency egress.
	[F20,F22-OH4] Applies to walls that support floors.
	[F20,F22-OH1.1,OH1.2,OH1.3] Applies to elements that support or are part of an environmental separator.
(2)	[F20-OS2.1,OS2.3,OS2.5] [F22-OS2.3,OS2.4,OS2.5]
	[F20-OP2.1,OP2.3,OP2.5] [F22-OP2.3,OP2.4,OP2.5]
	[F20,F22-OS1.2] Applies to assemblies required to provide fire resistance.
	[F22-OS3.1] Applies to walls that support floors. [F22-OS3.7] Applies to walls that contain doors or windows required for emergency egress.
	[F20,F22-OH4] Applies to walls that support floors.
	[F20,F22-OH1.1,OH1.2,OH1.3] Applies to elements that support or are part of an environmental separator.
<b>9.23.13.6. Materials in Braced Wall Panels</b>	
(1)	[F20-OS2.1,OS2.3,OS2.5] [F22-OS2.3,OS2.4,OS2.5]
	[F20-OP2.1,OP2.3,OP2.5] [F22-OP2.3,OP2.4,OP2.5]
	[F20,F22-OS1.2] Applies to assemblies required to provide fire resistance.
	[F22-OS3.1] Applies to walls that support floors. [F22-OS3.7] Applies to walls that contain doors or windows required for emergency egress.
	[F20,F22-OH4] Applies to walls that support floors.
	[F20,F22-OH1.1,OH1.2,OH1.3] Applies to elements that support or are part of an environmental separator.
(2)	[F20-OS2.1,OS2.3,OS2.5] [F22-OS2.3,OS2.4,OS2.5]
	[F20-OP2.1,OP2.3,OP2.5] [F22-OP2.3,OP2.4,OP2.5]
	[F20,F22-OS1.2] Applies to assemblies required to provide fire resistance.
	[F22-OS3.1] Applies to walls that support floors.
	[F20,F22-OH4] Applies to walls that support floors.
(4)	[F20-OS2.1,OS2.3,OS2.5] [F22-OS2.3,OS2.4,OS2.5]
	[F20-OP2.1,OP2.3,OP2.5] [F22-OP2.3,OP2.4,OP2.5]
	[F20,F22-OS1.2] Applies to assemblies required to provide fire resistance.
	[F22-OS3.1] Applies to walls that support floors. [F22-OS3.7] Applies to walls that contain doors or windows required for emergency egress.
	[F20,F22-OH4] Applies to walls that support floors.

	[F20,F22-OH1.1,OH1.2,OH1.3] Applies to elements that support or are part of an environmental separator.
(5)	[F20-OS2.1,OS2.3,OS2.5] [F22-OS2.3,OS2.4,OS2.5]
	[F20-OP2.1,OP2.3,OP2.5] [F22-OP2.3,OP2.4,OP2.5]
	[F20,F22-OS1.2] Applies to assemblies required to provide fire resistance.
	[F22-OS3.1] Applies to walls that support floors. [F22-OS3.7] Applies to walls that contain doors or windows required for emergency egress.
	[F20,F22-OH4] Applies to walls that support floors.
	[F20,F22-OH1.1,OH1.2,OH1.3]
(6)	[F20-OS2.1,OS2.3,OS2.5] [F22-OS2.3,OS2.4,OS2.5]
	[F20-OP2.1,OP2.3,OP2.5] [F22-OP2.3,OP2.4,OP2.5]
	[F20,F22-OS1.2] Applies to assemblies required to provide fire resistance.
	[F22-OS3.1] Applies to walls that support floors. [F22-OS3.7] Applies to walls that contain doors or windows required for emergency egress.
	[F20,F22-OH4] Applies to walls that support floors.
	[F20,F22-OH1.1,OH1.2,OH1.3] Applies to elements that support or are part of an environmental separator.
<b>9.23.13.7. Additional System Considerations</b>	
(7)	[F20-OS2.1,OS2.3,OS2.5] [F22-OS2.3,OS2.4,OS2.5]
	[F20-OP2.1,OP2.3,OP2.5] [F22-OP2.3,OP2.4,OP2.5]
	[F20,F22-OS1.2] Applies to assemblies required to provide fire resistance.
	[F22-OS3.1] Applies to walls that support floors. [F22-OS3.7] Applies to walls that contain doors or windows required for emergency egress.
	[F20,F22-OH4] Applies to walls that support floors.
	[F20,F22-OH1.1,OH1.2,OH1.3] Applies to elements that support or are part of an environmental separator.
<b>9.23.14.1. Continuity of Rafters and Joists</b>	
(1)	[F20-OS2.1,OS2.5] [F22-OS2.5] [F20,F22-OS2.3] Applies to elements that support or are part of an environmental separator.
	[F20-OP2.1,OP2.5] [F22-OP2.5] [F20,F22-OP2.3] Applies to elements that support or are part of an environmental separator.
	[F20,F22-OH1.1,OH1.2,OH1.3] Applies to elements that support or are part of an environmental separator.
	[F20,F22-OS1.2] Applies to assemblies required to provide fire resistance.
<b>9.23.14.2. Framing around Openings</b>	
(1)	[F20-OS2.1,OS2.5] [F22-OS2.5] [F20,F22-OS2.3] Applies to elements that support or are part of an environmental separator.
	[F20-OP2.1,OP2.5] [F22-OP2.5] [F20,F22-OP2.3] Applies to elements that support or are part of an environmental separator.

	[F20,F22-OH1.1,OH1.2,OH1.3] Applies to elements that support or are part of an environmental separator.
	[F20,F22-OS1.2] Applies to assemblies required to provide fire resistance.
<b>9.23.14.3. End Bearing Length</b>	
(1)	[F20-OS2.1,OS2.5] [F22-OS2.5] [F20,F22-OS2.3] Applies to elements that support or are part of an environmental separator.
	[F20-OP2.1,OP2.5] [F22-OP2.5] [F20,F22-OP2.3] Applies to elements that support or are part of an environmental separator.
	[F20,F22-OS1.2] Applies to assemblies required to provide fire resistance.
	[F20,F22-OH1.1,OH1.2,OH1.3] Applies to elements that support or are part of an environmental separator.
<b>9.23.14.4. Location and Attachment of Rafters</b>	
(1)	[F20-OS2.1,OS2.3,OS2.5] [F22-OS2.3,OS2.5]
	[F20-OP2.1,OP2.3,OP2.5] [F22-OP2.3,OP2.5]
	[F20,F22-OH1.1,OH1.2,OH1.3]
	[F20,F22-OS1.2] Applies to assemblies required to provide fire resistance.
(2)	[F20-OS2.1,OS2.3,OS2.5] [F22-OS2.3,OS2.5]
	[F20-OP2.1,OP2.3,OP2.5] [F22-OP2.3,OP2.5]
	[F20,F22-OH1.1,OH1.2,OH1.3]
	[F20,F22-OS1.2] Applies to assemblies required to provide fire resistance.
(3)	[F20-OS2.1,OS2.3,OS2.5] [F22-OS2.3,OS2.5]
	[F20-OP2.1,OP2.3,OP2.5] [F22-OP2.3,OP2.5]
	[F20,F22-OH1.1,OH1.2,OH1.3]
	[F20,F22-OS1.2] Applies to assemblies required to provide fire resistance.
<b>9.23.14.5. Shaping of Rafters</b>	
(1)	[F20-OS2.1,OS2.3,OS2.5] [F22-OS2.3,OS2.5]
	[F20-OP2.1,OP2.3,OP2.5] [F22-OP2.3,OP2.5]
	[F20,F22-OH1.1,OH1.2,OH1.3]
	[F20,F22-OS1.2] Applies to assemblies required to provide fire resistance.
<b>9.23.14.6. Hip and Valley Rafters</b>	
(1)	[F20-OS2.1,OS2.3,OS2.5] [F22-OS2.3,OS2.5]
	[F20-OP2.1,OP2.3,OP2.5] [F22-OP2.3,OP2.5]
	[F20,F22-OH1.1,OH1.2,OH1.3]
<b>9.23.14.7. Intermediate Support for Rafters and Joists</b>	
(1)	[F20-OS2.1,OS2.3,OS2.5] [F22-OS2.3,OS2.5]
	[F20-OP2.1,OP2.3,OP2.5] [F22-OP2.3,OP2.5]
	[F20,F22-OH1.1,OH1.2,OH1.3]

	[F20,F22-OS1.2] Applies to assemblies required to provide fire resistance.
(2)	[F20-OS2.1,OS2.3,OS2.5] [F22-OS2.3,OS2.5]
	[F20-OP2.1,OP2.3,OP2.5] [F22-OP2.3,OP2.5]
(4)	[F20-OS2.1,OS2.3,OS2.5] [F22-OS2.3,OS2.5]
	[F20-OP2.1,OP2.3,OP2.5] [F22-OP2.3,OP2.5]
	[F20,F22-OH1.1,OH1.2,OH1.3]
	[F20,F22-OS1.2] Applies to assemblies required to provide fire resistance.
(5)	[F20-OS2.1,OS2.3,OS2.5] [F22-OS2.3,OS2.5]
	[F20-OP2.1,OP2.3,OP2.5] [F22-OP2.3,OP2.5]
	[F20,F22-OH1.1,OH1.2,OH1.3]
	[F20,F22-OS1.2] Applies to assemblies required to provide fire resistance.
(6)	[F20-OP2.1,OP2.3,OP2.5] [F22-OP2.3,OP2.4,OP2.5]
	[F20,F22-OH1.1,OH1.2,OH1.3]
	[F20-OS2.1,OS2.3,OS2.5] [F22-OS2.3,OS2.5]
	[F22-OH4]
	[F20,F22-OS1.2] Applies to assemblies required to provide fire resistance.
	[F22-OS3.1] Applies to floors and elements that support floors. [F22-OS3.7] Applies to walls, and elements that support walls, that contain doors or windows required for emergency egress.
<b>9.23.14.8. Ridge Support</b>	
(1)	[F20-OS2.1,OS2.3,OS2.5] [F22-OS2.3,OS2.5]
	[F20-OP2.1,OP2.3,OP2.5] [F22-OP2.3,OP2.4,OP2.5]
	[F20,F22-OH1.1,OH1.2,OH1.3]
	[F20,F22-OS1.2] Applies to assemblies required to provide fire resistance.
	[F22-OS3.7] Applies to walls, and elements that support walls, that contain doors or windows required for emergency egress.
(3)	[F20-OS2.1,OS2.3,OS2.5] [F22-OS2.3,OS2.5]
	[F20-OP2.1,OP2.3,OP2.5] [F22-OP2.3,OP2.4,OP2.5]
	[F20,F22-OH1.1,OH1.2,OH1.3]
	[F20,F22-OS1.2] Applies to assemblies required to provide fire resistance.
	[F22-OS3.7] Applies to walls, and elements that support walls, that contain doors or windows required for emergency egress.
(4)	[F20-OS2.1,OS2.3,OS2.5] [F22-OS2.3,OS2.5]
	[F20-OP2.1,OP2.3,OP2.5] [F22-OP2.3,OP2.4,OP2.5]
	[F20,F22-OH1.1,OH1.2,OH1.3]
	[F20,F22-OS1.2] Applies to assemblies required to provide fire resistance.
	[F22-OS3.7] Applies to walls, and elements that support walls, that contain doors or windows required for emergency egress.
(5)	[F20-OS2.1,OS2.3,OS2.5] [F22-OS2.3,OS2.5]

	[F20-OP2.1,OP2.3,OP2.5] [F22-OP2.3,OP2.4,OP2.5]
	[F20,F22-OH1.1,OH1.2,OH1.3]
	[F20,F22-OS1.2] Applies to assemblies required to provide fire resistance.
	[F22-OS3.7] Applies to walls, and elements that support walls, that contain doors or windows required for emergency egress.
(6)	[F20-OS2.1,OS2.3,OS2.5] [F22-OS2.3,OS2.5]
	[F20-OP2.1,OP2.3,OP2.5] [F22-OP2.3,OP2.4,OP2.5]
	[F20,F22-OH1.1,OH1.2,OH1.3]
	[F20,F22-OS1.2] Applies to assemblies required to provide fire resistance.
	[F22-OS3.7] Applies to walls, and elements that support walls, that contain doors or windows required for emergency egress.
(7)	[F20-OS2.1,OS2.3,OS2.5] [F22-OS2.3,OS2.5]
	[F20-OP2.1,OP2.3,OP2.5] [F22-OP2.3,OP2.4,OP2.5]
	[F20,F22-OH1.1,OH1.2,OH1.3]
	[F20,F22-OS1.2] Applies to assemblies required to provide fire resistance.
	[F22-OS3.7] Applies to walls, and elements that support walls, that contain doors or windows required for emergency egress.
(8)	[F20-OS2.1,OS2.3,OS2.5] [F22-OS2.3,OS2.5]
	[F20-OP2.1,OP2.3,OP2.5] [F22-OP2.3,OP2.4,OP2.5]
	[F20,F22-OH1.1,OH1.2,OH1.3]
	[F20,F22-OS1.2] Applies to assemblies required to provide fire resistance.
	[F22-OS3.7] Applies to walls, and elements that support walls, that contain doors or windows required for emergency egress.
(9)	[F20-OS2.1,OS2.3,OS2.5] [F22-OS2.3,OS2.5]
	[F20-OP2.1,OP2.3,OP2.5] [F22-OP2.3,OP2.4,OP2.5]
	[F20,F22-OH1.1,OH1.2,OH1.3]
	[F20,F22-OS1.2] Applies to assemblies required to provide fire resistance.
	[F20,F22-OS3.7] Applies to walls, and elements that support walls, that contain doors or windows required for emergency egress.
<b>9.23.14.9. Restraint of Joist Bottoms</b>	
(1)	[F20-OS2.1,OS2.3,OS2.5] [F22-OS2.3,OS2.5]
	[F20-OP2.1,OP2.3,OP2.5] [F22-OP2.3,OP2.5]
	[F20,F22-OH1.1,OH1.2,OH1.3]
	[F20,F22-OS1.2] Applies to assemblies required to provide fire resistance.
<b>9.23.14.10. Ceiling Joists Supporting Roof Load</b>	
(1)	[F20-OS2.1,OS2.3,OS2.5] [F22-OS2.3,OS2.5]
	[F20-OP2.1,OP2.3,OP2.5] [F22-OP2.3,OP2.5]
	[F20,F22-OH1.1,OH1.2,OH1.3]
	[F20,F22-OS1.2] Applies to assemblies required to provide fire resistance.

(2)	[F20-OS2.1,OS2.3,OS2.5] [F22-OS2.3,OS2.5]
	[F20-OP2.1,OP2.3,OP2.5] [F22-OP2.3,OP2.5]
	[F20,F22-OH1.1,OH1.2,OH1.3]
	[F20,F22-OS1.2] Applies to assemblies required to provide fire resistance.
<b>9.23.14.11. Roof Trusses</b>	
(1)	[F20-OS2.1,OS2.3,OS2.5] [F22-OS2.3,OS2.5]
	[F20-OP2.1,OP2.3,OP2.5] [F22-OP2.3,OP2.5]
	[F20,F22-OH1.1,OH1.2,OH1.3]
	[F20,F22-OS1.2] Applies to assemblies required to provide fire resistance.
(3)	[F20-OS2.1,OS2.3,OS2.5] [F22-OS2.3,OS2.5]
	[F20-OP2.1,OP2.3,OP2.5] [F22-OP2.3,OP2.5]
<b>9.23.15.1. Subflooring Required</b>	
(1)	[F20-OS2.1]
<b>9.23.15.2. Material Standards</b>	
(1)	[F22-OS3.1]
	[F22-OP2.4]
	[F22-OH4]
	[F20-OS2.1]
(2)	[F80-OS3.1]
	[F80-OP2.4]
	[F80-OH4]
	[F80-OS2.1]
(3)	[F22-OS3.1]
	[F22-OP2.4]
	[F22-OH4]
	[F20-OS2.1]
(4)	[F80-OS3.1]
	[F80-OP2.4]
	[F80-OH4]
	[F80-OH1.1]
<b>9.23.15.3. Edge Support</b>	
(1)	[F22-OS3.1]
	[F22-OP2.4]
	[F22-OH4]
<b>9.23.15.4. Direction of Installation</b>	
(1)	[F22-OS3.1]
	[F22-OP2.4]



	[F22-OH4]
(2)	[F22-OS3.1]
	[F22-OP2.4]
	[F22-OH4]
<b>9.23.15.5. Subfloor Thickness or Rating</b>	
(1)	[F22-OS3.1]
	[F22-OP2.4]
	[F22-OH4]
	[F20-OS2.1]
(2)	[F20-OS2.1]
	[F22-OS3.1]
	[F22-OH4]
	[F22-OP2.4]
(3)	[F20-OS2.1]
	[F22-OH4]
	[F22-OS3.1]
	[F22-OP2.4]
<b>9.23.15.6. Annular Grooved Nails</b>	
(1)	[F81-OS2.3]
	[F81-OP2.3]
	[F81-OH1.1]
<b>9.23.15.7. Lumber Subflooring</b>	
(1)	[F22-OS3.1]
	[F22-OP2.4]
	[F22-OH4]
(2)	[F22-OS3.1]
	[F22-OP2.4]
	[F22-OH4]
(3)	[F22-OS3.1]
	[F22-OP2.4]
<b>9.23.16.1. Required Roof Sheathing</b>	
(1)	[F20-OS2.1,OS2.3,OS2.5] [F22-OS2.3,OS2.4,OS2.5]
	[F20-OP2.1,OP2.3,OP2.5] [F22-OP2.3,OP2.4,OP2.5]
	[F20,F22-OH1.1,OH1.2,OH1.3]
<b>9.23.16.2. Material Standards</b>	
(1)	[F20-OS2.1,OS2.3,OS2.5] [F22-OS2.3,OS2.5]
	[F20-OP2.1,OP2.3,OP2.5] [F22-OP2.3,OP2.5]

	[F20,F22-OH1.1,OH1.2,OH1.3]
	[F20,F22-OS1.2] Applies to assemblies required to provide fire resistance.
<b>9.23.16.3. Direction of Installation</b>	
(1)	[F20-OS2.1,OS2.3,OS2.5] [F22-OS2.3,OS2.5]
	[F20-OP2.1,OP2.3,OP2.5] [F22-OP2.3,OP2.5]
	[F20,F22-OH1.1,OH1.2,OH1.3]
	[F20,F22-OS1.2] Applies to assemblies required to provide fire resistance.
(2)	[F20-OS2.1,OS2.3,OS2.5] [F22-OS2.3,OS2.5]
	[F20-OP2.1,OP2.3,OP2.5] [F22-OP2.3,OP2.5]
	[F20,F22-OH1.1,OH1.2,OH1.3]
	[F20,F22-OS1.2] Applies to assemblies required to provide fire resistance.
<b>9.23.16.4. Joints in Panel-Type Sheathing</b>	
(1)	[F20-OS2.1,OS2.3,OS2.5] [F22-OS2.3,OS2.5]
	[F20-OP2.1,OP2.3,OP2.5] [F22-OP2.3,OP2.5]
	[F20,F22-OH1.1,OH1.2,OH1.3]
	[F20,F22-OS1.2] Applies to assemblies required to provide fire resistance.
(2)	[F20-OS2.1,OS2.3,OS2.5] [F22-OS2.3,OS2.5]
	[F20-OP2.1,OP2.3,OP2.5] [F22-OP2.3,OP2.5]
	[F20,F22-OH1.1,OH1.2,OH1.3]
	[F20,F22-OS1.2] Applies to assemblies required to provide fire resistance.
<b>9.23.16.5. Lumber Roof Sheathing</b>	
(1)	[F20-OS2.1,OS2.3,OS2.5] [F22-OS2.3,OS2.5]
	[F20-OP2.1,OP2.3,OP2.5] [F22-OP2.3,OP2.5]
	[F20,F22-OH1.1,OH1.2,OH1.3]
	[F20,F22-OS1.2] Applies to assemblies required to provide fire resistance.
(2)	[F20-OS2.1,OS2.3,OS2.5] [F22-OS2.3,OS2.4,OS2.5]
	[F20-OP2.1,OP2.3,OP2.5] [F22-OP2.3,OP2.4,OP2.5]
	[F20,F22-OS1.2] Applies to assemblies required to provide fire resistance.
	[F20,F22-OH1.1,OH1.2,OH1.3]
<b>9.23.16.6. Edge Support</b>	
(1)	[F20-OS2.1,OS2.3,OS2.5] [F22-OS2.3,OS2.5]
	[F20-OP2.1,OP2.3,OP2.5] [F22-OP2.3,OP2.5]
	[F20,F22-OH1.1,OH1.2,OH1.3]
	[F20,F22-OS1.2] Applies to assemblies required to provide fire resistance.
<b>9.23.16.7. Thickness or Rating</b>	
(1)	[F20-OS2.1,OS2.3,OS2.5] [F22-OS2.3,OS2.5]
	[F20-OP2.1,OP2.3,OP2.5] [F22-OP2.3,OP2.4,OP2.5]

	[F20,F22-OH1.1,OH1.2,OH1.3]
	[F22-OH4]
	[F22-OS3.1]
(2)	[F20-OS2.1,OS2.3,OS2.5] [F22-OS2.3,OS2.5]
	[F20-OP2.1,OP2.3,OP2.5] [F22-OP2.3,OP2.5]
	[F20,F22-OH1.1,OH1.2,OH1.3]
	[F20,F22-OS1.2] Applies to assemblies required to provide fire resistance.
(3)	[F20-OS2.1,OS2.3,OS2.5] [F22-OS2.3,OS2.5]
	[F20-OP2.1,OP2.3,OP2.5] [F22-OP2.3,OP2.5]
	[F20,F22-OH1.1,OH1.2,OH1.3]
(4)	[F20-OS2.1,OS2.3,OS2.5] [F22-OS2.3,OS2.5]
	[F20-OP2.1,OP2.3,OP2.5] [F22-OP2.3,OP2.5]
	[F20,F22-OH1.1,OH1.2,OH1.3]
<b>9.23.17.1. Required Sheathing</b>	
(1)	[F20-OS2.1,OS2.3,OS2.5] [F22-OS2.3,OS2.5]
	[F20-OP2.1,OP2.3,OP2.5] [F22-OP2.3,OP2.4,OP2.5]
	[F20,F22-OH1.1,OH1.2,OH1.3]
	[F22-OS3.1] Applies to floors and elements that support floors. [F22-OS3.7] Applies to walls, and elements that support walls, that contain doors or windows required for emergency egress.
	[F20,F22-OH4] Applies to floors and elements that support floors.
<b>9.23.17.2. Thickness, Rating and Material Standards</b>	
(1)	[F20-OS2.1,OS2.3,OS2.5] [F22-OS2.3,OS2.5]
	[F20-OP2.1,OP2.3,OP2.5] [F22-OP2.3,OP2.4,OP2.5]
	[F20,F22-OH1.1,OH1.2,OH1.3]
	[F20,F22-OS1.2] Applies to assemblies required to provide fire resistance.
	[F20,F22-OH4] Applies to floors and elements that support floors.
	[F20,F22-OS3.1] Applies to floors and elements that support floors.
<b>9.23.17.4. Lumber Sheathing</b>	
(1)	[F20-OS2.1,OS2.3,OS2.5] [F22-OS2.3,OS2.5]
	[F20-OP2.1,OP2.3,OP2.5] [F22-OP2.3,OP2.4,OP2.5]
	[F20,F22-OH1.1,OH1.2,OH1.3]
	[F20,F22-OS1.2] Applies to assemblies required to provide fire resistance.
	[F20,F22-OH4] Applies to floors and elements that support floors.
	[F20,F22-OS3.1] Applies to floors and elements that support floors.
(2)	[F20-OS2.1,OS2.3,OS2.5] [F22-OS2.3,OS2.5]
	[F20-OP2.1,OP2.3,OP2.5] [F22-OP2.3,OP2.4,OP2.5]
	[F20,F22-OH1.1,OH1.2,OH1.3]

	[F20,F22-OS1.2] Applies to assemblies required to provide fire resistance.
	[F22-OS3.1] Applies to floors and elements that support floors. [F22-OS3.7] Applies to walls, and elements that support walls, that contain doors or windows required for emergency egress.
	[F20,F22-OH4] Applies to floors and elements that support floors.
<b>9.23.17.5. Joints in Panel-Type Sheathing</b>	
(1)	[F80,F81-OS2.3]
	[F80,F81-OP2.3,OP2.4]
	[F80,F81-OH1.1,OH1.2,OH1.3]
	[F80,F81-OH4] Applies to floors and elements that support floors.
	[F80,F81-OS3.1] Applies to floors and elements that support floors.
<b>9.24.1.2. Material Standards</b>	
(1)	[F20-OP2.1,OP2.4] [F22,F80-OP2.4] [F20,F22,F80-OP2.3] Applies to elements that support or are part of an environmental separator.
	[F20-OS2.1,OS2.4] [F22,F80-OS2.4] [F20,F22,F80-OS2.3] Applies to elements that support or are part of an environmental separator.
	[F20,F22,F80-OH1.1,OH1.2,OH1.3]
	[F20,F22,F80-OS1.2] Applies to assemblies required to provide fire resistance.
	[F22,F80-OS3.7] Applies to walls, and elements that support walls, that contain doors or windows required for emergency egress.
<b>9.24.1.4. Screws</b>	
(1)	[F20-OP2.1,OP2.4] [F22,F80-OP2.4] [F20,F22,F80-OP2.3] Applies to elements that support or are part of an environmental separator.
	[F20,F22,F80-OS2.1] [F20,F22,F80-OS2.3] Applies to elements that support or are part of an environmental separator.
	[F20,F22,F80-OH1.1,OH1.2,OH1.3]
	[F20,F22,F80-OS1.2] Applies to assemblies required to provide fire resistance.
	[F22,F80-OS3.7] Applies to walls, and elements that support walls, that contain doors or windows required for emergency egress.
<b>9.24.1.5. Cladding, Sheathing and Interior Finish Required</b>	
(1)	[F20,F22,F80-OH1.1,OH1.2,OH1.3]
	[F20,F22,F80-OS2.1] [F20,F22,F80-OS2.3] Applies to elements that support or are part of an environmental separator.
	[F20,F22,F80-OP2.1,OP2.4] [F20,F22,F80-OP2.3] Applies to elements that support or are part of an environmental separator.
	[F20,F22,F80-OS1.2] Applies to assemblies required to provide fire resistance.
	[F22,F80-OS3.7] Applies to walls, and elements that support walls, that contain doors or windows required for emergency egress.
<b>9.24.2.1. Size and Spacing of Studs in Interior Walls</b>	
(1)	[F20-OP2.1,OP2.4] [F22-OP2.4]

	[F20-OS2.1,OS2.4] [F22-OS2.4]
	[F22-OS3.7] Applies to walls, and elements that support walls, that contain doors or windows required for emergency egress.
<b>9.24.2.2. Thickness of Studs</b>	
(1)	[F20-OP2.1,OP2.4] [F22-OP2.4]
	[F20-OS2.1,OS2.4] [F22-OS2.4]
	[F22-OS3.7] Applies to walls, and elements that support walls, that contain doors or windows required for emergency egress.
<b>9.24.2.3. Runners</b>	
(1)	[F20,F22-OH1.1,OH1.2,OH1.3]
	[F20-OS2.1,OS2.4] [F22-OS2.4] [F20,F22-OS2.3] Applies to elements that support or are part of an environmental separator.
	[F20-OP2.1,OP2.4] [F22-OP2.4] [F20,F22-OP2.3] Applies to elements that support or are part of an environmental separator.
	[F20,F22-OS1.2] Applies to assemblies required to provide fire resistance.
<b>9.24.2.4. Openings in Fire Separations</b>	
(1)	[F20-OS1.2]
(2)	[F20-OS1.2]
(3)	[F20-OS1.2]
(4)	[F20-OS1.2]
<b>9.24.2.5. Size and Spacing of Studs in Exterior Walls</b>	
(1)	[F20,F22-OH1.1,OH1.2,OH1.3]
	[F20-OS2.1,OS2.3,OS2.4] [F22-OS2.3,OS2.4]
	[F20-OP2.1,OP2.3,OP2.4] [F22-OP2.3,OP2.4]
	[F20,F22-OS1.2] Applies to assemblies required to provide fire resistance.
	[F22,F80-OS3.7] Applies to walls, and elements that support walls, that contain doors or windows required for emergency egress.
<b>9.24.3.1. Installation of Runners</b>	
(1)	[F20-OP2.1,OP2.4] [F22-OP2.4] [F20,F22-OP2.3] Applies to elements that support or are part of an environmental separator.
	[F20,F22-OH1.1,OH1.2,OH1.3]
	[F20-OS2.1,OS2.4] [F22-OS2.4] [F20,F22-OS2.3] Applies to elements that support or are part of an environmental separator.
	[F20,F22-OS1.2] Applies to assemblies required to provide fire resistance.
	[F22,F80-OS3.7] Applies to walls, and elements that support walls, that contain doors or windows required for emergency egress.
(2)	[F20,F22-OH1.1,OH1.2,OH1.3]

	[F20-OS2.1,OS2.4] [F22-OS2.4] [F20,F22-OS2.3] Applies to elements that support or are part of an environmental separator.
	[F20-OP2.1,OP2.4] [F22-OP2.4] [F20,F22-OP2.3] Applies to elements that support or are part of an environmental separator.
	[F20,F22-OS1.2] Applies to assemblies required to provide fire resistance.
	[F22-OS3.7] Applies to walls, and elements that support walls, that contain doors or windows required for emergency egress.
(3)	[F20,F22-OH1.1,OH1.2,OH1.3]
	[F20,F22-OS2.1,OS2.4] [F20,F22-OS2.3] Applies to elements that support or are part of an environmental separator.
	[F20,F22-OP2.1,OP2.4] [F20,F22-OP2.3] Applies to elements that support or are part of an environmental separator.
	[F20,F22-OS1.2] Applies to assemblies required to provide fire resistance.
	[F22-OS3.7] Applies to walls, and elements that support walls, that contain doors or windows required for emergency egress.
(4)	[F20,F22-OH1.1,OH1.2,OH1.3]
	[F20-OS2.1,OS2.4] [F22-OS2.4] [F20,F22-OS2.3] Applies to elements that support or are part of an environmental separator.
	[F20-OP2.1,OP2.4] [F22-OP2.4] [F20,F22-OP2.3] Applies to elements that support or are part of an environmental separator.
	[F22-OS3.7] Applies to walls, and elements that support walls, that contain doors or windows required for emergency egress.
	[F20,F22-OS1.2] Applies to assemblies required to provide fire resistance.
<b>9.24.3.2. Fire-Rated Walls</b>	
(1)	[F21-OS1.2]
(2)	[F21-OS1.2]
(3)	[F20-OS1.2]
(4)	[F20-OS1.2]
(5)	[F03-OS1.2]
<b>9.24.3.3. Orientation of Studs</b>	
(1)	[F20,F22-OH1.1,OH1.2,OH1.3]
	[F20-OS2.1,OS2.4] [F22-OS2.4] [F20,F22-OS2.3] Applies to elements that support or are part of an environmental separator.
	[F20-OP2.1,OP2.4] [F22-OP2.4] [F20,F22-OP2.3] Applies to elements that support or are part of an environmental separator.
	[F20,F22-OS1.2] Applies to assemblies required to provide fire resistance.
	[F22-OS3.7] Applies to walls, and elements that support walls, that contain doors or windows required for emergency egress.

<b>9.24.3.4. Support for Cladding Materials</b>	
(1)	[F20-OH1.1,OH1.2,OH1.3]
	[F20-OS2.1,OS2.4] [F20-OS2.3] Applies to elements that support or are part of an environmental separator.
	[F20-OP2.1,OP2.4] [F20-OP2.3] Applies to elements that support or are part of an environmental separator.
	[F20-OS1.2] Applies to assemblies required to provide fire resistance.
	[F22-OS3.7] Applies to walls, and elements that support walls, that contain doors or windows required for emergency egress.
<b>9.24.3.5. Framing around Openings</b>	
(1)	[F20,F22-OH1.1,OH1.2,OH1.3]
	[F20-OS2.1,OS2.4] [F22-OS2.4] [F20,F22-OS2.3] Applies to elements that support or are part of an environmental separator.
	[F20-OP2.1,OP2.4] [F22-OP2.4] [F20,F22-OP2.3] Applies to elements that support or are part of an environmental separator.
	[F20,F22-OS1.2] Applies to assemblies required to provide fire resistance.
	[F22-OS3.7] Applies to walls, and elements that support walls, that contain doors or windows required for emergency egress.
(2)	[F20,F22-OH1.1,OH1.2,OH1.3]
	[F20-OS2.1,OS2.4] [F22-OS2.4] [F20,F22-OS2.3] Applies to elements that support or are part of an environmental separator.
	[F20-OP2.1,OP2.4] [F22-OP2.4] [F20,F22-OP2.3] Applies to elements that support or are part of an environmental separator.
	[F20,F22-OS1.2] Applies to assemblies required to provide fire resistance.
	[F22-OS3.7] Applies to walls, and elements that support walls, that contain doors or windows required for emergency egress.
<b>9.24.3.6. Attachment of Studs to Runners</b>	
(1)	[F20-OS2.1,OS2.4] [F22-OS2.4] [F20,F22-OS2.3] Applies to elements that support or are part of an environmental separator.
	[F20-OP2.1,OP2.4] [F22-OP2.4] [F20,F22-OP2.3] Applies to elements that support or are part of an environmental separator.
	[F20,F22-OH1.1,OH1.2,OH1.3]
	[F20,F22-OS1.2] Applies to assemblies required to provide fire resistance.
	[F22-OS3.7] Applies to walls, and elements that support walls, that contain doors or windows required for emergency egress.
(2)	[F21-OS1.2]
<b>9.24.3.7. Openings for Fire Dampers</b>	
(1)	[F20-OS1.2]

(2)	[F20-OS1.2]
(3)	[F03-OS1.2]
<b>9.25.1.1. Scope and Application</b>	
(2)	[F51,F63-OH1.1,OH1.2] [F55-OH1.1,OH1.2,OH1.3] [F55,F63-OS2.3]
<b>9.25.2.1. Required Insulation</b>	
(1)	[F51,F63-OH1.1,OH1.2] [F63-OS2.3]
<b>9.25.2.2. Insulation Materials</b>	
(1)	[F51,F63,F80-OH1.1,OH1.2] [F63,F80-OS2.3]
(3)	[F51,F63-OH1.1,OH1.2] [F63-OS2.3]
<b>9.25.2.3. Installation of Thermal Insulation</b>	
(1)	[F51,F63-OH1.1,OH1.2] [F63-OS2.3]
(2)	[F51,F63-OH1.1,OH1.2] [F63-OS2.3]
(3)	[F55-OH1.1,OH1.2] [F55-OS2.3]
(4)	[F51,F63,F80-OH1.1,OH1.2] [F63,F80-OS2.3]
(5)	[F21-OH1.1,OH1.2,OH1.3] [F21-OS2.2,OS2.3]
(6)	[F80-OH1.1,OH1.2] [F80-OS2.3]
(7)	[F80-OH1.1,OH1.2] [F80-OS2.3]
(8)	[F21-OH1.1,OH1.2] [F21-OS2.3]
<b>9.25.2.4. Installation of Loose-Fill Insulation</b>	
(1)	[F51,F63-OH1.1,OH1.2] [F63-OS2.3]
(2)	[F51-OH1.1,OH1.2,OH1.3] [F51-OS2.3]
(4)	(a) [F21,F51-OS2.3] (a) [F21,F51-OH1.1,OH1.2]



	(c) [F81-OS2.1,OS2.3] (c) [F81-OS2.1,OS2.3,OS2.4,OS2.5] Applies where the interior finish provides the required bracing.
	(c) [F81-OH1.1,OH1.2] (c) [F81-OH1.1,OH1.2,OH1.3] Applies where the interior finish provides the required bracing.
	(c) [F81-OP2.1,OP2.3,OP2.4,OP2.5] Applies where the interior finish provides to the required bracing.
	(c) [F81-OP3.1] Applies where the interior finish contributes to the required fire resistance of the wall.
	(c) [F81-OS3.7] Applies where the interior finish provides the required bracing. (c) [F81-OS3.1] Applies where the interior finish provides the required bracing of walls that support floors.
	(c) [F81-OH4] Applies where the interior finish provides the required bracing of walls that support floors.
	(d) [F80-OS2.3]
	(d) [F80-OH1.1,OH1.2,OH1.3]
(5)	[F51,F63-OH1.1,OH1.2] [F63-OS2.3]
(6)	(a) [F51,F62-OH1.1,OH1.2,OH1.3] (b) [F51,F63-OH1.1,OH1.2]  (a) [F62,F51-OS2.3] (b) [F51,F63-OS2.3]
<b>9.25.2.5. Installation of Spray-Applied Polyurethane</b>	
(1)	[F51,F41,F63-OH1.1] [F51,F63-OH1.2] [F63-OS2.3]
<b>9.25.3.1. Required Barrier to Air Leakage</b>	
(1)	[F55-OH1.1,OH1.2,OH1.3] [F40-OH1.1] [F55-OS2.3] [F44-OS1.1] Applies where the <i>air barrier system</i> separates a garage, or <i>suite</i> containing a garage, from residential space. [F44-OS3.4] Applies where the <i>air barrier system</i> separates a garage, or <i>suite</i> containing a garage, from residential space.
<b>9.25.3.2. Air Barrier System Properties</b>	
(1)	[F20,F55-OH1.1,OH1.2,OH1.3] [F40-OH1.1] [F20,F55-OS2.3] [F20,F44-OS1.1] Applies where the <i>air barrier system</i> separates a garage, or <i>suite</i> containing a garage, from residential space. [F20,F44-OS3.4] Applies where the <i>air barrier system</i> separates a garage, or <i>suite</i> containing a garage, from residential space.
(2)	[F20,F80,F55-OH1.1,OH1.2,OH1.3] [F40-OH1.1] [F20,F80,F55-OS2.3] [F20,F80,F44-OS1.1] Applies where the <i>air barrier system</i> separates a garage, or <i>suite</i> containing a garage, from residential space. [F20,F80,F44-OS3.4] Applies where the <i>air barrier system</i> separates a garage, or <i>suite</i> containing a garage, from residential space.
<b>9.25.3.3. Continuity of the Air Barrier System</b>	

(1)	[F55-OH1.1,OH1.2,OH1.3] [F40-OH1.1]
	[F55-OS2.3]
	[F44-OS1.1] Applies where the <i>air barrier system</i> separates a garage, or <i>suite</i> containing a garage, from residential space.
	[F44-OS3.4] Applies where the <i>air barrier system</i> separates a garage, or <i>suite</i> containing a garage, from residential space.
(2)	[F55-OH1.1,OH1.2,OH1.3] [F40-OH1.1]
	(a) [F44-OS3.4] Applies where the <i>air barrier system</i> separates a garage, or <i>suite</i> containing a garage, from residential space.
	[F55-OS2.3]
	(a) [F44-OS1.1] Applies where the <i>air barrier system</i> separates a garage, or <i>suite</i> containing a garage, from residential space.
(6)	[F55-OH1.1,OH1.2,OH1.3] [F40-OH1.1]
	[F55-OS2.3]
	[F44-OS1.1] Applies where the <i>air barrier system</i> separates a garage, or <i>suite</i> containing a garage, from residential space.
	[F44-OS3.4] Applies where the <i>air barrier system</i> separates a garage, or <i>suite</i> containing a garage, from residential space.
(7)	[F55-OH1.1,OH1.2,OH1.3] [F40-OH1.1]
	[F55-OS2.3]
(8)	[F01-OS1.1]
<b>9.25.3.4. Air Leakage Control in Masonry Walls</b>	
(1)	[F40-OH1.1]
(2)	[F40-OH1.1]
<b>9.25.3.5. Air Leakage Control in Underground Roofs</b>	
(1)	[F40-OH1.1]
<b>9.25.3.6. Air Barrier Systems in Floors-on-ground</b>	
(1)	[F40-OH1.1]
(2)	[F40-OH1.1]
(3)	[F40-OH1.1]
(5)	[F40-OH1.1]
(6)	[F40-OH1.1]
<b>9.25.4.1. Required Barrier to Vapour Diffusion</b>	
(1)	[F63-OH1.1,OH1.2]
	[F63-OS2.3]
<b>9.25.4.2. Vapour Barrier Materials</b>	
(1)	[F63-OS2.3]
	[F63-OH1.1,OH1.2]
(2)	[F63-OS2.3]

	[F63-OH1.1,OH1.2,OH1.3]
(3)	[F62,F63-OS2.3]
	[F62,F63-OH1.1,OH1.2,OH1.3]
(4)	[F63,F80-OS2.3]
	[F63,F80-OH1.1,OH1.2]
(5)	[F63,F80-OS2.3]
	[F63,F80-OH1.1,OH1.2]
(6)	[F63,F80-OS2.3]
	[F63,F80-OH1.1,OH1.2]
(7)	[F63-OS2.3]
	[F63-OH1.1,OH1.2]
(8)	[F63-OS2.3]
	[F63-OH1.1,OH1.2]
<b>9.25.4.3. Installation of Vapour Barriers</b>	
(1)	[F63-OH1.1,OH1.2]
	[F63-OS2.3]
(2)	[F63-OH1.1,OH1.2]
	[F63-OS2.3]
(3)	[F63-OS2.3]
	[F63-OH1.1,OH1.2]
<b>9.25.5.1. General</b>	
(2)	[F62,F63-OS2.3]
	[F62,F63-OH1.1,OH1.2,OH1.3]
<b>9.25.5.2. Position of Low Permeance Materials</b>	
(1)	[F62,F63-OS2.3]
	[F62,F63-OH1.1,OH1.2]
<b>9.26.1.2. Required Protection</b>	
(1)	[F61-OH1.1,OH1.2,OH1.3]
	[F61-OS2.3]
<b>9.26.1.3. Alternative Installation Methods</b>	
(1)	[F61-OH1.1,OH1.2,OH1.3]
	[F61-OS2.3]
<b>9.26.2.1. Material Standards</b>	
(1)	[F61-OH1.1,OH1.2,OH1.3]
	[F61-OS2.3]
(2)	[F61-OH1.1,OH1.2,OH1.3]
	[F61-OS2.3]

<b>9.26.2.2. Installation of Materials</b>	
(1)	[F61-OH1.2,OH1.3,OH1.1]
	[F61-OS2.3]
<b>9.26.2.3. Nails</b>	
(1)	[F20,F80-OH1.1,OH1.2,OH1.3]
	[F20,F80-OS2.3]
(2)	[F20-OH1.1,OH1.2,OH1.3]
	[F20-OS2.3]
(3)	[F20-OH1.1,OH1.2,OH1.3]
	[F20-OS2.3]
(4)	[F20,F80-OH1.1,OH1.2,OH1.3]
	[F20,F80-OS2.3]
<b>9.26.2.4. Staples</b>	
(1)	[F20,F80-OH1.1,OH1.2,OH1.3]
	[F20,F80-OS2.3]
(2)	[F20-OH1.1,OH1.2,OH1.3]
	[F20-OS2.3]
(3)	[F20,F80-OH1.1,OH1.2,OH1.3]
	[F20,F80-OS2.3]
<b>9.26.3.1. Slope</b>	
(1)	[F20-OS2.1,OS2.3] [F61,F80-OS2.3]
	[F20,F61,F80-OH1.1,OH1.2,OH1.3]
(2)	[F20,F61,F80-OS2.3]
	[F20,F61,F80-OH1.1,OH1.2,OH1.3]
(3)	[F61,F80-OS2.3]
	[F61,F80-OH1.1,OH1.2,OH1.3]
(4)	[F61,F80-OS2.3]
	[F61,F80-OH1.1,OH1.2,OH1.3]
(5)	[F21-OS2.3]
	[F21-OH1.1,OH1.2,OH1.3]
<b>9.26.4.1. Required Flashing at Intersections</b>	
(1)	[F61-OS2.3]
	[F61-OH1.1,OH1.2,OH1.3]
<b>9.26.4.2. Materials</b>	
(1)	[F61,F62,F80-OH1.1,OH1.2,OH1.3]
	[F61,F62,F80-OS2.3]
<b>9.26.4.3. Valley Flashing</b>	

(1)	[F61-OS2.3]
	[F61-OH1.1,OH1.2,OH1.3]
(2)	[F20-OS2.1,OS2.3] [F22-OS2.3,OS2.4]
	[F20,F22-OH1.1,OH1.2,OH1.3]
(3)	[F61-OS2.3]
	[F61-OH1.1,OH1.2,OH1.3]
(4)	[F20,F61,F80-OH1.1,OH1.2,OH1.3]
	[F20,F61,F80-OS2.3]
(5)	[F20,F61,F80-OH1.1,OH1.2,OH1.3]
	[F20,F61,F80-OS2.3]
(6)	[F20,F61,F80-OH1.1,OH1.2,OH1.3]
	[F20,F61,F80-OS2.3]
<b>9.26.4.4. Intersection of Shingle Roofs and Masonry</b>	
(1)	[F61-OH1.1,OH1.2,OH1.3]
	[F61-OS2.3]
	[F61-OS1.1] Applies where a shingle roof intersects with a masonry <i>chimney</i> .
	[F61-OP1.1] Applies where a shingle roof intersects with a masonry <i>chimney</i> .
	[F61-OS3.4] Applies where a shingle roof intersects with a masonry <i>chimney</i> .
(2)	[F61-OH1.1,OH1.2,OH1.3]
	[F61-OS2.3]
	[F61-OS1.1] Applies where counter flashing is installed between a shingle roof and a masonry <i>chimney</i> .
	[F61-OP1.1] Applies where counter flashing is installed between a shingle roof and a masonry <i>chimney</i> .
	[F61-OS3.4] Applies where counter flashing is installed between a shingle roof and a masonry <i>chimney</i> .
(3)	[F61-OH1.1,OH1.2,OH1.3]
	[F61-OS2.3]
	[F61-OS1.1] Applies where flashing is installed between a shingle roof and a masonry <i>chimney</i> .
	[F61-OP1.1] Applies where flashing is installed between a shingle roof and a masonry <i>chimney</i> .
	[F61-OS3.4] Applies where flashing is installed between a shingle roof and a masonry <i>chimney</i> .
(4)	[F61-OH1.1,OH1.2,OH1.3]
	[F61-OS2.3]
	[F61-OS1.1] Applies where a shingle roof slopes upward from a masonry <i>chimney</i> .
	[F61-OP1.1] Applies where a shingle roof slopes upward from a masonry <i>chimney</i> .
	[F61-OS3.4] Applies where a shingle roof slopes upward from a masonry <i>chimney</i> .
<b>9.26.4.5. Intersection of Shingle Roofs and Walls other than Masonry</b>	
(1)	[F61-OH1.1,OH1.2,OH1.3]
	[F61-OS2.3]
(2)	[F61-OH1.1,OH1.2,OH1.3]

	[F61-OS2.3]
(3)	[F61-OH1.1,OH1.2,OH1.3]
	[F61-OS2.3]
<b>9.26.4.6. Intersection of Built-Up Roofs and Masonry</b>	
(1)	[F61-OH1.1,OH1.2,OH1.3]
	[F61-OS2.3]
	[F61-OS1.1] Applies where a built-up roof intersects with a masonry <i>chimney</i> .
	[F61-OP1.1] Applies where a built-up roof intersects with a masonry <i>chimney</i> .
	[F61-OS3.4] Applies where a built-up roof intersects with a masonry <i>chimney</i> .
(2)	[F61-OH1.1,OH1.2,OH1.3]
	[F61-OS2.3]
	[F61-OS1.1] Applies where counter flashing is installed between a built-up roof and a masonry <i>chimney</i> .
	[F61-OP1.1] Applies where counter flashing is installed between a built-up roof and a masonry <i>chimney</i> .
	[F61-OS3.4] Applies where counter flashing is installed between a built-up roof and a masonry <i>chimney</i> .
<b>9.26.4.7. Intersection of Built-Up Roofs and Walls other than Masonry</b>	
(1)	[F61-OH1.1,OH1.2,OH1.3]
	[F61-OS2.3]
(2)	[F61-OH1.1,OH1.2,OH1.3]
	[F61-OS2.3]
(3)	[F61-OH1.1,OH1.2,OH1.3]
	[F61-OS2.3]
<b>9.26.4.8. Chimney Saddles</b>	
(1)	[F61-OH1.1,OH1.2,OH1.3]
	[F61-OS2.3]
	[F61-OS1.1]
	[F61-OP1.1]
	[F61-OS3.4]
(2)	[F20,F81-OH1.1,OH1.2,OH1.3]
	[F20,F81-OS2.3]
	[F20,F81-OS1.1]
	[F20,F81-OP1.1]
	[F20,F81-OS3.4]
(3)	[F61-OH1.1,OH1.2,OH1.3]
	[F61-OS2.3]
(5)	[F61-OH1.1,OH1.2,OH1.3]
	[F61-OS2.3]
	[F61-OS1.1]

	[F61-OP1.1]
	[F61-OS3.4]
<b>9.26.5.1. Required Eave Protection</b>	
(1)	[F61-OH1.1,OH1.2,OH1.3]
	[F61-OS2.3]
<b>9.26.5.2. Materials</b>	
(1)	[F61-OH1.1,OH1.2,OH1.3]
	[F61-OS2.3]
<b>9.26.6.1. Materials</b>	
(1)	[F61-OH1.1,OH1.2,OH1.3]
	[F61-OS2.3]
(2)	[F62-OH1.1,OH1.2,OH1.3]
	[F62-OS2.3]
<b>9.26.6.2. Installation</b>	
(1)	[F61-OH1.1,OH1.2,OH1.3]
	[F61-OS2.3]
(2)	[F61-OH1.1,OH1.2,OH1.3]
	[F61-OS2.3]
(3)	[F61-OH1.1,OH1.2,OH1.3]
	[F61-OS2.3]
<b>9.26.7.1. Coverage</b>	
(1)	[F61,F80-OH1.1,OH1.2,OH1.3]
	[F61,F80-OS2.1]
<b>9.26.7.2. Starter Strip</b>	
(1)	[F61-OH1.1,OH1.2,OH1.3]
	[F61-OS2.3]
(2)	[F61,F80-OH1.1,OH1.2,OH1.3]
	[F61,F80-OS2.3]
(3)	[F61-OH1.1,OH1.2,OH1.3]
	[F61-OS2.3]
<b>9.26.7.3. Head Lap</b>	
(1)	[F61-OH1.1,OH1.2,OH1.3]
	[F61-OS2.3]
<b>9.26.7.4. Fasteners</b>	
(1)	[F20,F61-OH1.1,OH1.2,OH1.3]
	[F20,F61-OS2.3]
(2)	[F20-OH1.1,OH1.2,OH1.3]

	[F20-OS2.3]
(3)	[F20-OH1.1,OH1.2,OH1.3]
	[F20-OS2.3]
(4)	[F20-OH1.1,OH1.2,OH1.3]
	[F20-OS2.3]
(5)	[F20-OH1.1,OH1.2,OH1.3]
	[F20-OS2.3]
<b>9.26.7.5. Securing of Tabs</b>	
(1)	[F20,F61-OH1.1,OH1.2,OH1.3]
	[F20,F61-OS2.3]
<b>9.26.7.6. Hips and Ridges</b>	
(1)	[F61-OH1.1,OH1.2,OH1.3]
	[F61-OS2.3]
(2)	[F20-OH1.1,OH1.2,OH1.3]
	[F20-OS2.3]
<b>9.26.8.1. Coverage</b>	
(1)	[F61-OH1.1,OH1.2,OH1.3]
	[F61-OS2.3]
<b>9.26.8.2. Starter Strip</b>	
(2)	[F61-OH1.1,OH1.2,OH1.3]
	[F61-OS2.3]
<b>9.26.8.3. Securing of Tabs</b>	
(1)	[F61-OH1.1,OH1.2,OH1.3]
	[F61-OS2.3]
<b>9.26.8.4. Securing of Shingle Courses</b>	
(1)	[F61-OH1.1,OH1.2,OH1.3]
	[F61-OS2.3]
(2)	[F61-OH1.1,OH1.2,OH1.3]
	[F61-OS2.3]
(3)	[F61-OS2.3]
	[F61-OH1.1,OH1.2,OH1.3]
<b>9.26.8.5. Hips and Ridges</b>	
(1)	[F61-OH1.1,OH1.2,OH1.3]
	[F61-OS2.3]
(2)	[F61,F80-OS2.3]
	[F61,F80-OH1.1,OH1.2,OH1.3]
<b>9.26.9.2. Grade</b>	



(1)	[F61-OH1.1,OH1.2,OH1.3]
	[F61-OS2.3]
(2)	[F61-OH1.1,OH1.2,OH1.3]
	[F61-OS2.3]
<b>9.26.9.3. Size</b>	
(1)	[F61-OH1.1,OH1.2,OH1.3]
	[F61-OS2.3]
<b>9.26.9.4. Spacing and Joints</b>	
(1)	[F61-OH1.1,OH1.2,OH1.3]
	[F61-OS2.3]
<b>9.26.9.5. Fastening</b>	
(1)	[F20,F80-OH1.1,OH1.2,OH1.3]
	[F20,F80-OS2.3]
<b>9.26.9.6. Exposure</b>	
(1)	[F61-OH1.1,OH1.2,OH1.3]
	[F61-OS2.3]
<b>9.26.10.1. Size and Thickness</b>	
(1)	[F61-OH1.1,OH1.2,OH1.3]
	[F61-OS2.3]
<b>9.26.10.2. Underlay</b>	
(1)	[F61-OH1.1,OH1.2,OH1.3]
	[F61-OS2.3]
(2)	[F61-OH1.1,OH1.2,OH1.3]
	[F61-OS2.3]
(3)	[F61-OH1.1,OH1.2,OH1.3]
	[F61-OS2.3]
<b>9.26.10.3. Spacing and Joints</b>	
(1)	[F61-OH1.1,OH1.2,OH1.3]
	[F61-OS2.3]
<b>9.26.10.4. Fastening</b>	
(1)	[F20,F80-OH1.1,OH1.2,OH1.3]
	[F20,F80-OS2.3]
<b>9.26.10.5. Exposure</b>	
(1)	[F61-OH1.1,OH1.2,OH1.3]
	[F61-OS2.3]
<b>9.26.10.8. Grade</b>	
(1)	[F61-OH1.1,OH1.2,OH1.3]

	[F61-OS2.3]
<b>9.26.11.1. Quantity of Materials</b>	
(1)	[F61-OH1.1,OH1.2,OH1.3]
	[F61-OS2.3]
<b>9.26.11.2. Coal-Tar and Asphalt Products</b>	
(1)	[F61,F80-OH1.1,OH1.2,OH1.3]
	[F61,F80-OS2.3]
<b>9.26.11.3. Roof Felts</b>	
(1)	[F20-OH1.1,OH1.2,OH1.3]
	[F20-OS2.3]
<b>9.26.11.4. Aggregate Surfacing</b>	
(1)	[F61-OH1.1,OH1.2,OH1.3]
	[F61-OS2.3]
(2)	[F61-OH1.1,OH1.2,OH1.3]
	[F61-OS2.3]
<b>9.26.11.6. Number of Layers</b>	
(1)	[F20,F80-OH1.1,OH1.2,OH1.3]
	[F20,F80-OS2.3]
<b>9.26.11.7. Installation of Layers</b>	
(1)	[F20-OH1.1,OH1.2,OH1.3]
	[F20-OS2.3]
(2)	[F61,F81-OH1.1,OH1.2,OH1.3]
	[F61,F81-OS2.3]
(3)	[F20-OH1.1,OH1.2,OH1.3]
	[F20-OS2.3]
<b>9.26.11.8. Roofing over Wood-Based Sheathing</b>	
(1)	[F61-OH1.1,OH1.2,OH1.3]
	[F61-OS2.3]
(2)	[F61-OH1.1,OH1.2,OH1.3]
	[F61-OS2.3]
<b>9.26.11.9. Attachment to Decking</b>	
(1)	[F61-OH1.1,OH1.2,OH1.3]
	[F61-OS2.3]
<b>9.26.11.10. Cant Strips</b>	
(1)	[F61-OH1.1,OH1.2,OH1.3]
	[F61-OS2.3]
	[F61-OS3.1]

(2)	[F61-OH1.1,OH1.2,OH1.3]
	[F61-OS2.3]
(3)	[F61-OH1.1,OH1.2,OH1.3]
	[F61-OS2.3]
(4)	[F61-OH1.1,OH1.2,OH1.3]
	[F61-OS2.3]
	[F61-OS3.1]
(5)	[F61-OH1.1,OH1.2,OH1.3]
	[F61-OS2.3]
(6)	[F61-OH1.1,OH1.2,OH1.3]
	[F61-OS2.3]
<b>9.26.12.1. Coverage</b>	
(1)	[F61,F80-OH1.1,OH1.2,OH1.3]
	[F61,F80-OS2.3]
<b>9.26.12.2. Joints</b>	
(1)	[F61-OH1.1,OH1.2,OH1.3]
	[F61-OS2.3]
<b>9.26.13.1. Thickness</b>	
(1)	[F61,F80-OH1.1,OH1.2,OH1.3]
	[F61,F80-OS2.3]
<b>9.26.13.2. Support</b>	
(1)	[F20-OS2.1,OS2.3] [F22-OS2.3,OS2.4]
	[F20-OP2.1,OP2.3] [F22-OP2.3,OP2.4]
	[F20,F22-OH1.1,OH1.2,OH1.3]
<b>9.26.14.1. Support</b>	
(1)	[F20,F22-OH1.1,OH1.2,OH1.3]
	[F20-OS2.1,OS2.3] [F22-OS2.3,OS2.4]
	[F20-OP2.1,OP2.3] [F22-OP2.3,OP2.4]
<b>9.26.15.1. Installation</b>	
(1)	[F61,F80-OH1.1,OH1.2,OH1.3]
	[F61,F80-OS2.3]
<b>9.26.16.1. Installation</b>	
(1)	[F61,F80-OH1.1,OH1.2,OH1.3]
	[F61,F80-OS2.3]
<b>9.26.17.1. Installation</b>	
(1)	[F61-OH1.1,OH1.2,OH1.3]
	[F61-OS2.3]

<b>9.26.18.2. Downspouts</b>	
(1)	[F61-OH1.1,OH1.2,OH1.3]
	[F61-OS2.3]
<b>9.27.2.1. Minimizing and Preventing Ingress and Damage</b>	
(1)	[F61-OS2.3]
	[F61-OH1.1,OH1.2,OH1.3]
(2)	[F80,F81-OS2.3]
	[F80,F81-OH1.1,OH1.2,OH1.3]
<b>9.27.2.2. Minimum Protection from Precipitation Ingress</b>	
(3)	[F62-OS2.3]
	[F62-OH1.1,OH1.2,OH1.3]
(4)	[F61,F62-OS2.3]
	[F61,F62-OH1.1,OH1.2,OH1.3]
(5)	[F61,F62-OS2.3]
	[F61,F62-OH1.1,OH1.2,OH1.3]
<b>9.27.2.3. First and Second Planes of Protection</b>	
(1)	[F61,F62-OS2.3]
	[F61,F62-OH1.1,OH1.2,OH1.3]
<b>9.27.2.4. Protection of Cladding from Moisture</b>	
(1)	[F61,F80-OS2.3]
	[F61,F80-OH1.1,OH1.2,OH1.3]
(2)	[F61,F80-OS2.3]
	[F61-OH1.1,OH1.2,OH1.3]
<b>9.27.3.1. Elements of the Second Plane of Protection</b>	
(1)	[F61,F62-OS2.3]
	[F61,F62-OH1.1,OH1.2,OH1.3]
(3)	[F61,F62-OS2.3]
	[F61,F62-OH1.1,OH1.2,OH1.3]
<b>9.27.3.2. Sheathing Membrane Material Standard</b>	
(1)	[F20,F61,F62,F55-OS2.3]
	[F20,F61,F62,F55-OH1.1,OH1.2,OH1.3]
<b>9.27.3.3. Required Sheathing Membrane and Installation</b>	
(1)	[F61,F55-OS2.3]
	[F61,F55-OH1.1,OH1.2,OH1.3]
(2)	[F61,F55-OS2.3]
	[F61,F55-OH1.1,OH1.2,OH1.3]
(3)	[F61-OS2.3]

	[F61-OH1.1,OH1.2,OH1.3]
<b>9.27.3.4. Insulating Sheathing in lieu of Sheathing Membrane</b>	
(2)	[F61,F55-OS2.3]
	[F61,F55-OH1.1,OH1.2,OH1.3]
<b>9.27.3.5. Sheathing Membranes in lieu of Sheathing</b>	
(1)	[F61,F55-OS2.3]
	[F61,F55-OH1.1,OH1.2,OH1.3]
(2)	[F61,F55-OS2.3]
	[F61,F55-OH1.1,OH1.2,OH1.3]
<b>9.27.3.6. Face Sealed Cladding</b>	
(2)	[F20,F61,F55-OS2.3]
	[F20,F61,F55-OH1.1,OH1.2,OH1.3]
(3)	[F61,F55-OS2.3]
	[F61,F55-OH1.1,OH1.2,OH1.3]
<b>9.27.3.7. Flashing Materials</b>	
(1)	[F61,F62,F80-OS2.3]
	[F61,F62,F80-OH1.1,OH1.2,OH1.3]
<b>9.27.3.8. Flashing Installation</b>	
(1)	(a),(b),(c)(i) [F61-OS2.3]
	(a),(b),(c)(i) [F61-OH1.1,OH1.2,OH1.3]
	(c)(ii) [F61,F62-OS2.3]
	(c)(ii) [F61,F62-OH1.1,OH1.2,OH1.3]
(2)	(a),(b)(ii),(c)(i) [F61-OS2.3] Applies to detailing of horizontal joints.
	(a),(b)(ii),(c)(i) [F61-OH1.1,OH1.2,OH1.3] Applies to detailing of horizontal joints.
	(b)(i),(c)(ii) [F61,F62-OS2.3] Applies to cladding installed outboard of a drained and vented air space.
	(b)(i),(c)(ii) [F61,F62-OH1.1,OH1.2,OH1.3] Applies to cladding installed outboard of a drained and vented air space.
(3)	[F61,F62-OS2.3]
	[F61,F62-OH1.1,OH1.2,OH1.3]
(4)	[F61,F62-OS2.3]
	[F61,F62-OH1.1,OH1.2,OH1.3]
(5)	[F61,F62-OS2.3]
	[F61,F62-OH1.1,OH1.2,OH1.3]
<b>9.27.4.1. Required Sealants</b>	
(1)	[F61-OH1.1,OH1.2,OH1.3]
	[F61-OS2.3]
(2)	[F61-OH1.1,OH1.2,OH1.3]

	[F61-OS2.3]
(3)	[F61-OH1.1,OH1.2,OH1.3]
	[F61-OS2.3]
<b>9.27.4.2. Materials</b>	
(1)	[F80-OH1.1,OH1.2,OH1.3]
	[F80-OS2.3]
(2)	[F80-OH1.1,OH1.2,OH1.3]
	[F80-OS2.3]
(3)	[F80-OH1.1,OH1.2,OH1.3]
	[F80-OS2.3]
<b>9.27.5.1. Attachment</b>	
(1)	[F20-OS2.1,OS2.3] [F20-OS2.1,OS2.3,OS2.4] [F22-OS2.3,OS2.4,OS2.5] Applies where panel-type cladding is installed to provide the required bracing.
	[F20-OP2.1,OP2.3,OP2.4] [F22-OP2.3,OP2.4,OP2.5] Applies where panel-type cladding is installed to provide the required bracing.
	[F20-OH1.1,OH1.2,OH1.3] [F20,F22-OH1.1,OH1.2,OH1.3] Applies where panel-type cladding is installed to provide the required bracing.
	[F20,F22-OH4] Applies where panel-type cladding is installed to provide the required bracing of walls that support floors.
	[F20,F22-OS3.1] Applies where panel-type cladding is installed to provide the required bracing of walls that support floors. [F20,F22-OS3.7] Applies where panel-type cladding is installed to provide required bracing of walls that contain doors or windows required for emergency egress.
(2)	[F20-OH1.1,OH1.2,OH1.3]
	[F20-OS2.1,OS2.3]
(3)	[F20-OH1.1,OH1.2,OH1.3]
	[F20-OS2.3]
(4)	[F20-OH1.1,OH1.2,OH1.3]
	[F20-OS2.1,OS2.3]
<b>9.27.5.2. Blocking</b>	
(1)	[F20-OH1.1,OH1.2,OH1.3] [F20,F22-OH1.1,OH1.2,OH1.3] Applies where panel-type cladding is installed to provide the required bracing.
	[F20-OS2.1,OS2.3] [F20-OS2.1,OS2.3,OS2.4] [F22-OS2.3,OS2.4,OS2.5] Applies where panel-type cladding is installed to provide the required bracing.
	[F20-OP2.1,OP2.3,OP2.4] [F22-OP2.3,OP2.4,OP2.5] Applies where panel-type cladding is installed to provide the required bracing.
<b>9.27.5.3. Furring</b>	
(1)	[F20-OH1.1,OH1.2,OH1.3]

	[F20-OS2.1,OS2.3] [F20-OS2.1,OS2.3,OS2.4] [F22-OS2.3,OS2.4,OS2.5] Applies where furring is used for the attachment of panel-type cladding installed to provide the required bracing.
(2)	[F20-OH1.1,OH1.2,OH1.3] [F20,F22-OH1.1,OH1.2,OH1.3] Applies where furring is used for the attachment of panel-type cladding installed to provide the required bracing.
	[F20-OS2.1,OS2.3] [F20-OS2.1,OS2.3,OS2.4] [F22-OS2.3,OS2.4,OS2.5] Applies where furring is used for the attachment of panel-type cladding installed to provide the required bracing.
(3)	[F20-OH1.1,OH1.2,OH1.3] [F20,F22-OH1.1,OH1.2,OH1.3] Applies where furring is used for the attachment of panel-type cladding installed to provide the required bracing.
	[F20-OS2.1,OS2.3] [F20-OS2.1,OS2.3,OS2.4] [F22-OS2.3,OS2.4,OS2.5] Applies where furring is used for the attachment of panel-type cladding installed to provide the required bracing.
<b>9.27.5.4. Size and Spacing of Fasteners</b>	
(1)	[F20-OH1.1,OH1.2,OH1.3] [F20,F22-OH1.1,OH1.2,OH1.3] Applies to the attachment of panel-type cladding installed to provide the required bracing.
	[F20-OS2.1,OS2.3] [F20-OS2.1,OS2.3,OS2.4] [F22-OS2.3,OS2.4,OS2.5] Applies where panel-type cladding is installed to provide the required bracing.
(2)	[F20-OH1.1,OH1.2,OH1.3]
	[F20-OS2.1,OS2.3]
<b>9.27.5.5. Fastener Materials</b>	
(1)	[F80-OH1.1,OH1.2,OH1.3]
	[F80-OS2.3] [F80-OS2.3,OS2.4] Applies where panel-type cladding is installed to provide the required bracing.
	[F80-OP2.1,OP2.3,OP2.4,OP2.5] Applies where panel-type cladding is installed to provide the required bracing.
<b>9.27.5.6. Expansion and Contraction</b>	
(1)	[F21-OH1.1,OH1.2,OH1.3]
	[F21-OS2.3]
(2)	[F21-OH1.1,OH1.2,OH1.3]
	[F21-OS2.3]
<b>9.27.5.7. Penetration of Fasteners</b>	
(1)	[F20-OH1.1,OH1.2,OH1.3]
	[F20-OS2.1,OS2.3]
(2)	[F20-OH1.1,OH1.2,OH1.3]
	[F20-OS2.1,OS2.3]
(3)	[F20-OH1.1,OH1.2,OH1.3] [F20,F22-OH1.1,OH1.2,OH1.3] Applies where panel-type cladding is installed to provide the required bracing.

	[F20-OS2.1,OS2.3] [F20-OS2.1,OS2.3,OS2.4] [F22-OS2.3,OS2.4,OS2.5] Applies where panel-type cladding is installed to provide the required bracing.
	[F20-OP2.1,OP2.3,OP2.4] [F22-OP2.3,OP2.4,OP2.5] Applies where panel-type cladding is installed to provide the required bracing.
<b>9.27.6.1. Materials</b>	
(1)	[F61,F20-OH1.1,OH1.2,OH1.3]
	[F62,F20-OS2.3]
<b>9.27.6.2. Thickness and Width</b>	
(1)	[F20-OH1.1,OH1.2,OH1.3]
	[F20-OS2.3]
(2)	[F20-OH1.1,OH1.2,OH1.3]
	[F20-OS2.3]
(3)	[F20-OH1.1,OH1.2,OH1.3]
	[F20-OS2.3]
<b>9.27.6.3. Joints</b>	
(1)	[F61-OH1.1,OH1.2,OH1.3]
	[F61-OS2.3]
(2)	[F21,F61-OH1.1,OH1.2,OH1.3]
	[F21,F61-OS2.3]
<b>9.27.7.1. Materials</b>	
(1)	[F61-OH1.1,OH1.2,OH1.3]
	[F61-OS2.3]
(2)	[F61,F20-OH1.1,OH1.2,OH1.3]
	[F61,F20-OS2.3]
(3)	[F61,F20-OH1.1,OH1.2,OH1.3]
	[F61,F20-OS2.3]
<b>9.27.7.2. Width</b>	
(1)	[F61,F20-OH1.1,OH1.2,OH1.3]
	[F61,F20-OS2.3]
<b>9.27.7.3. Fasteners</b>	
(1)	[F61,F20-OH1.1,OH1.2,OH1.3]
	[F61,F20-OS2.3]
<b>9.27.7.4. Offsetting of Joints</b>	
(1)	[F61-OH1.1,OH1.2,OH1.3]
	[F61-OS2.3]
(2)	[F61-OH1.1,OH1.2,OH1.3]
	[F61-OS2.3]



<b>9.27.7.5. Fastening to Lath</b>	
(1)	[F81-OH1.1,OH1.2,OH1.3]
	[F81-OS2.3]
(2)	[F62-OH1.1,OH1.2,OH1.3]
	[F62-OS2.3]
(3)	[F20-OH1.1,OH1.2,OH1.3]
	[F20-OS2.3]
(4)	[F20-OH1.1,OH1.2,OH1.3]
	[F20-OS2.3]
(5)	[F62-OH1.1,OH1.2,OH1.3]
	[F62-OS2.3]
<b>9.27.7.6. Exposure and Thickness</b>	
(1)	[F62,F20-OH1.1,OH1.2,OH1.3]
	[F62,F20-OS2.3]
<b>9.27.8.1. Material Standards</b>	
(1)	[F20,F22-OH1.1,OH1.2,OH1.3]
	[F20-OS2.1,OS2.3] [F20-OS2.1,OS2.3,OS2.4] [F22-OS2.3,OS2.4,OS2.5] Applies where panel-type cladding is installed to provide the required bracing.
	[F20-OP2.1,OP2.3,OP2.4] [F22-OP2.3,OP2.4,OP2.5] Applies where panel-type cladding is installed to provide the required bracing.
<b>9.27.8.2. Thickness</b>	
(1)	[F20,F22-OH1.1,OH1.2,OH1.3]
	[F20,F22-OS2.1,OS2.3] [F20-OS2.1,OS2.3,OS2.4] [F22-OS2.3,OS2.4,OS2.5] Applies where panel-type cladding is installed to provide the required bracing.
(2)	[F20,F22-OH1.1,OH1.2,OH1.3]
	[F20-OS2.1,OS2.3] [F20-OS2.1,OS2.3,OS2.4] [F22-OS2.3,OS2.4,OS2.5] Applies where panel-type cladding is installed to provide the required bracing.
	[F20-OP2.1,OP2.3] [F22-OP2.3,OP2.4,OP2.5] Applies where panel-type cladding is installed to provide the required bracing.
<b>9.27.8.3. Edge Treatment</b>	
(1)	[F61-OH1.1,OH1.2,OH1.3]
	[F61-OS2.3] [F61-OS2.3,OS2.4,OS2.5] Applies where panel-type cladding is installed to provide the required bracing.
	[F61-OP2.3,OP2.4,OP2.5] Applies where panel-type cladding is installed to provide the required bracing.
<b>9.27.8.4. Panel Cladding</b>	
(1)	[F20,F22-OH1.1,OH1.2,OH1.3]

	[F20,F22-OS2.1,OS2.3] [F20-OS2.1,OS2.3,OS2.4] [F22-OS2.3,OS2.4,OS2.5] Applies where panel-type cladding is installed to provide the required bracing.
	[F20-OP2.1,OP2.3,OP2.4] [F22-OP2.3,OP2.4,OP2.5] Applies where panel-type cladding is installed to provide the required bracing.
(2)	[F21-OH1.1,OH1.2,OH1.3] [F21-OS2.3]
(3)	[F61-OH1.1,OH1.2,OH1.3] [F61-OS2.3]
(4)	[F61-OH1.1,OH1.2,OH1.3] [F61-OS2.3]
<b>9.27.8.5. Lapped Strip Siding</b>	
(1)	[F21,F61-OH1.1,OH1.2,OH1.3] [F21,F61-OS2.3]
(2)	[F61-OH1.1,OH1.2,OH1.3] [F61-OS2.3]
(3)	[F61-OH1.1,OH1.2,OH1.3] [F61-OS2.3]
<b>9.27.9.1. Material Standards</b>	
(1)	[F20,F22-OH1.1,OH1.2,OH1.3] [F20-OS2.1,OS2.3] [F20-OS2.1,OS2.3,OS2.4] [F22-OS2.3,OS2.4,OS2.5] Applies where panel-type cladding is installed to provide the required bracing.
<b>9.27.9.2. Thickness</b>	
(1)	[F20,F22-OH1.1,OH1.2,OH1.3] [F20,F22-OS2.1,OS2.3] [F20-OS2.1,OS2.3,OS2.4] [F22-OS2.3,OS2.4,OS2.5] Applies where panel-type cladding is installed to provide the required bracing. [F20-OP2.1,OP2.3,OP2.4] [F22-OP2.3,OP2.4,OP2.5] Applies where panel-type cladding is installed to provide the required bracing.
(2)	[F20,F22-OH1.1,OH1.2,OH1.3] [F20,F22-OS2.1,OS2.3] [F20-OS2.1,OS2.3,OS2.4] [F22-OS2.3,OS2.4,OS2.5] Applies where panel-type cladding is installed to provide the required bracing. [F20-OP2.1,OP2.3,OP2.4] [F22-OP2.3,OP2.4,OP2.5] Applies where panel-type cladding is installed to provide the required bracing.
<b>9.27.9.3. Panel Cladding</b>	
(1)	[F20,F21,F22-OH1.1,OH1.2,OH1.3] [F20,F21,F22-OS2.1,OS2.3] [F20-OS2.1,OS2.3,OS2.4] [F22-OS2.3,OS2.4,OS2.5] Applies where panel-type cladding is installed to provide the required bracing. [F20-OP2.1,OP2.3,OP2.4] [F22-OP2.3,OP2.4,OP2.5] Applies where panel-type cladding is installed to provide the required bracing.

(2)	[F61-OH1.1,OH1.2,OH1.3]
	[F61-OS2.3]
(3)	[F61-OH1.1,OH1.2,OH1.3]
	[F61-OS2.3]
<b>9.27.9.4. Lapped Strip Siding</b>	
(1)	[F61-OH1.1,OH1.2,OH1.3]
	[F61-OS2.3]
(2)	[F61-OH1.1,OH1.2,OH1.3]
	[F61-OS2.3]
<b>9.27.9.5. Clearance</b>	
(1)	[F21-OH1.1,OH1.2,OH1.3]
	[F21-OS2.1,OS2.3] [F21-OS2.1,OS2.3,OS2.4,OS2.5] Applies where panel-type cladding is installed to provide the required bracing.
	[F21-OP2.1,OP2.3,OP2.4,OP2.5] Applies where panel-type cladding is installed to provide the required bracing.
<b>9.27.10.1. Material Standard</b>	
(1)	[F20,F22-OH1.1,OH1.2,OH1.3]
	[F20-OS2.1,OS2.3] [F20-OS2.1,OS2.3,OS2.4] [F22-OS2.3,OS2.4,OS2.5] Applies where panel-type cladding is installed to provide the required bracing.
<b>9.27.10.2. Thickness</b>	
(1)	[F20,F22-OH1.1,OH1.2,OH1.3]
	[F20,F22-OS2.1,OS2.3] [F20-OS2.1,OS2.3,OS2.4] [F22-OS2.3,OS2.4,OS2.5] Applies where panel-type cladding is installed to provide the required bracing.
(2)	[F20,F22-OH1.1,OH1.2,OH1.3]
	[F20,F22-OS2.1,OS2.3] [F20-OS2.1,OS2.3,OS2.4] [F22-OS2.3,OS2.4,OS2.5] Applies where panel-type cladding is installed to provide the required bracing.
	[F20-OP2.1,OP2.3,OP2.4] [F22-OP2.3,OP2.4,OP2.5] Applies where panel-type cladding is installed to provide the required bracing.
(3)	[F20,F22-OH1.1,OH1.2,OH1.3]
	[F20,F22-OS2.1,OS2.3] [F20-OS2.1,OS2.3,OS2.4] [F22-OS2.3,OS2.4,OS2.5] Applies where panel-type cladding is installed to provide the required bracing.
(4)	[F20,F22-OH1.1,OH1.2,OH1.3]
	[F20,F22-OS2.1,OS2.3] [F20-OS2.1,OS2.3,OS2.4] [F22-OS2.3,OS2.4,OS2.5] Applies where panel-type cladding is installed to provide the required bracing.
	[F20-OP2.1,OP2.3,OP2.4] [F22-OP2.3,OP2.4,OP2.5] Applies where panel-type cladding is installed to provide the required bracing.
<b>9.27.10.3. Panel Cladding</b>	

(1)	[F20,F22,F80-OH1.1,OH1.2,OH1.3]
	[F20,F22,F80-OS2.1,OS2.3] [F20,F80-OS2.1,OS2.3,OS2.4] [F22,F80-OS2.3,OS2.4,OS2.5] Applies where panel-type cladding is installed to provide the required bracing.
(2)	[F21-OH1.1,OH1.2,OH1.3]
	[F21-OS2.3]
(3)	[F61-OH1.1,OH1.2,OH1.3]
	[F61-OS2.3]
(4)	[F61-OH1.1,OH1.2,OH1.3]
	[F61-OS2.3]
<b>9.27.10.4. Clearance</b>	
(1)	[F21-OH1.1,OH1.2,OH1.3]
	[F21-OS2.1,OS2.3] [F21-OS2.1,OS2.3,OS2.4,OS2.5] Applies where panel-type cladding is installed to provide the required bracing.
	[F21-OP2.1,OP2.3,OP2.4,OP2.5] Applies where panel-type cladding is installed to provide the required bracing.
<b>9.27.11.1. Material Standards</b>	
(1)	[F20,F22,F61-OH1.1,OH1.2,OH1.3]
	[F20-OS2.1,OS2.3] [F22,F61-OS2.3] [F20-OS2.1,OS2.3,OS2.4] [F22-OS2.3,OS2.4,OS2.5] Applies where panel-type cladding is installed to provide the required bracing.
(2)	[F20,F22,F61-OH1.1,OH1.2,OH1.3]
	[F20-OS2.1,OS2.3] [F22,F61-OS2.3]
(3)	[F20,F22,F61-OH1.1,OH1.2,OH1.3]
	[F20-OS2.1,OS2.3] [F22,F61-OS2.3] [F20-OS2.1,OS2.3,OS2.4] [F22-OS2.3,OS2.4,OS2.5] Applies where panel-type cladding is installed to provide the required bracing.
<b>9.27.12.1. Material Standards</b>	
(1)	[F62,F61,F20-OH1.1,OH1.2,OH1.3]
	[F62,F61,F20-OS2.3]
(2)	[F62,F61,F20-OH1.1,OH1.2,OH1.3]
	[F62,F61,F20-OS2.3]
(3)	[F62,F61,F20,F42-OH1.1,OH1.2,OH1.3]
	[F62,F61,F20,F42-OS2.3]
(4)	[F02-OS1.2]
	[F02-OP1.2]
<b>9.27.13.1. Material Standard</b>	
(1)	[F62,F61,F20-OH1.1,OH1.2,OH1.3]
	[F62,F61,F20-OS2.3]
(2)	[F02-OS1.2]

	[F02-OP1.2]
<b>9.27.14.2. Materials</b>	
(1)	[F20,F61,F62-OH1.1,OH1.2,OH1.3]
	[F20,F61,F62-OS2.3]
(2)	[F20,F22-OH1.1,OH1.2,OH1.3]
	[F20,F22-OS2.3]
<b>9.27.14.3. Design and Installation</b>	
(1)	[F20,F61,F62-OH1.1,OH1.2,OH1.3]
	[F20,F61,F62-OS2.3]
<b>9.28.1.1. Sheathing beneath Stucco</b>	
(1)	[F20,F22-OH1.1,OH1.2,OH1.3]
	[F20,F22-OS2.3]
<b>9.28.1.2. Lath and Reinforcing</b>	
(1)	[F20-OH1.1,OH1.2,OH1.3]
	[F20-OS2.3]
(2)	[F20-OH1.1,OH1.2,OH1.3]
	[F20-OS2.3]
(3)	[F20,F21-OS1.1]
	[F20,F21-OS2.3]
	[F20,F21-OS3.4]
	[F20,F21-OP1.1]
	[F20,F21-OH1.1]
<b>9.28.1.3. Concrete Masonry Units</b>	
(1)	[F80-OH1.1,OH1.2,OH1.3]
	[F80-OS2.3]
	[F80-OS1.1] Applies where stucco is applied to masonry <i>chimneys</i> .
	[F80-OS3.4] Applies where stucco is applied to masonry <i>chimneys</i> .
	[F80-OP1.1] Applies where stucco is applied to masonry <i>chimneys</i> .
<b>9.28.1.4. Clearance over Ground Level</b>	
(1)	[F80-OH1.1,OH1.2,OH1.3]
	[F80-OS2.3]
<b>9.28.1.5. Flashing and Caulking</b>	
(1)	[F80-OH1.1,OH1.2,OH1.3] Applies to the separation of aluminum flashing from stucco.
	[F80-OS2.3] Applies to the separation of aluminum flashing from stucco.
<b>9.28.2.1. Portland Cement</b>	
(1)	[F20-OH1.1,OH1.2,OH1.3]
	[F20-OS2.3]

	[F20-OS1.1] Applies where stucco is applied to masonry <i>chimneys</i> .
	[F20-OS3.4] Applies where stucco is applied to masonry <i>chimneys</i> .
	[F20-OP1.1] Applies where stucco is applied to masonry <i>chimneys</i> .
<b>9.28.2.2. Aggregate</b>	
(1)	[F80-OH1.1,OH1.2,OH1.3]
	[F80-OS2.3]
	[F80-OS1.1] Applies where stucco is applied to masonry <i>chimneys</i> .
	[F80-OS3.4] Applies where stucco is applied to masonry <i>chimneys</i> .
	[F80-OP1.1] Applies where stucco is applied to masonry <i>chimneys</i> .
(2)	[F20,F80-OH1.1,OH1.2,OH1.3]
	[F20,F80-OS2.3]
	[F20,F80-OS1.1] Applies where stucco is applied to masonry <i>chimneys</i> .
	[F20,F80-OS3.4] Applies where stucco is applied to masonry <i>chimneys</i> .
	[F20,F80-OP1.1] Applies where stucco is applied to masonry <i>chimneys</i> .
<b>9.28.2.3. Water</b>	
(1)	[F80-OH1.1,OH1.2,OH1.3]
	[F80-OS2.3]
	[F80-OS1.1] Applies where stucco is applied to masonry <i>chimneys</i> .
	[F80-OS3.4] Applies where stucco is applied to masonry <i>chimneys</i> .
	[F80-OP1.1] Applies where stucco is applied to masonry <i>chimneys</i> .
<b>9.28.3.1. Materials</b>	
(1)	[F80-OH1.1,OH1.2,OH1.3]
	[F80-OS2.3]
	[F80-OS1.1] Applies where stucco is applied to masonry <i>chimneys</i> .
	[F80-OS3.4] Applies where stucco is applied to masonry <i>chimneys</i> .
	[F80-OP1.1] Applies where stucco is applied to masonry <i>chimneys</i> .
<b>9.28.3.2. Nails and Staples</b>	
(1)	[F20-OH1.1,OH1.2,OH1.3]
	[F20-OS2.3]
	[F20-OS1.1] Applies where stucco is applied to masonry <i>chimneys</i> .
	[F20-OS3.4] Applies where stucco is applied to masonry <i>chimneys</i> .
	[F20-OP1.1] Applies where stucco is applied to masonry <i>chimneys</i> .
(2)	[F20-OH1.1,OH1.2,OH1.3]
	[F20-OS2.3]
(3)	[F20-OH1.1,OH1.2,OH1.3]
	[F20-OS2.3]
	[F20-OS1.1] Applies where stucco is applied to masonry <i>chimneys</i> .

	[F20-OS3.4] Applies where stucco is applied to masonry <i>chimneys</i> .
	[F20-OP1.1] Applies where stucco is applied to masonry <i>chimneys</i> .
(4)	[F20-OS2.1]
<b>9.28.4.1. Materials</b>	
(1)	[F80-OH1.1,OH1.2,OH1.3]
	[F80-OS2.3]
	[F80-OS1.1] Applies where stucco is applied to masonry <i>chimneys</i> .
	[F80-OS3.4] Applies where stucco is applied to masonry <i>chimneys</i> .
	[F80-OP1.1] Applies where stucco is applied to masonry <i>chimneys</i> .
(2)	[F80-OH1.1,OH1.2,OH1.3]
	[F80-OS2.3]
	[F80-OS1.1] Applies where stucco is applied to masonry <i>chimneys</i> .
	[F80-OS3.4] Applies where stucco is applied to masonry <i>chimneys</i> .
	[F80-OP1.1] Applies where stucco is applied to masonry <i>chimneys</i> .
<b>9.28.4.2. No Sheathing Required</b>	
(1)	[F20-OH1.1,OH1.2,OH1.3]
	[F20-OS2.3]
<b>9.28.4.3. Stucco Lath Specifications</b>	
(1)	[F20-OH1.1,OH1.2,OH1.3]
	[F20-OS2.3]
	[F20-OS1.1] Applies where stucco is applied to masonry <i>chimneys</i> .
	[F20-OS3.4] Applies where stucco is applied to masonry <i>chimneys</i> .
	[F20-OP1.1] Applies where stucco is applied to masonry <i>chimneys</i> .
<b>9.28.4.4. Self-Furring Devices</b>	
(1)	[F20,F80-OH1.1,OH1.2,OH1.3]
	[F20,F80-OS2.3]
	[F20,F80-OS1.1] Applies where stucco is applied to masonry <i>chimneys</i> .
	[F20,F80-OS3.4] Applies where stucco is applied to masonry <i>chimneys</i> .
	[F20,F80-OP1.1] Applies where stucco is applied to masonry <i>chimneys</i> .
<b>9.28.4.5. Application of Stucco Lath</b>	
(1)	[F20-OH1.1,OH1.2,OH1.3]
	[F20-OS2.3]
	[F20-OS1.1] Applies where stucco is applied to masonry <i>chimneys</i> .
	[F20-OS3.4] Applies where stucco is applied to masonry <i>chimneys</i> .
	[F20-OP1.1] Applies where stucco is applied to masonry <i>chimneys</i> .
(2)	[F20-OH1.1,OH1.2,OH1.3]
	[F20-OS2.3]

	[F20-OS1.1] Applies where stucco is applied to masonry <i>chimneys</i> .
	[F20-OS3.4] Applies where stucco is applied to masonry <i>chimneys</i> .
	[F20-OP1.1] Applies where stucco is applied to masonry <i>chimneys</i> .
(3)	[F20-OH1.1,OH1.2,OH1.3]
	[F20-OS2.3]
(4)	[F20-OH1.1,OH1.2,OH1.3]
	[F20-OS2.3]
	[F20-OS1.1] Applies where stucco is applied to masonry <i>chimneys</i> .
	[F20-OS3.4] Applies where stucco is applied to masonry <i>chimneys</i> .
	[F20-OP1.1] Applies where stucco is applied to masonry <i>chimneys</i> .
<b>9.28.4.6. Fastening</b>	
(2)	[F20-OH1.1,OH1.2,OH1.3]
	[F20-OS2.3]
	[F20-OS1.1] Applies where stucco is applied to masonry <i>chimneys</i> .
	[F20-OS3.4] Applies where stucco is applied to masonry <i>chimneys</i> .
	[F20-OP1.1] Applies where stucco is applied to masonry <i>chimneys</i> .
(3)	[F20-OH1.1,OH1.2,OH1.3]
	[F20-OS2.3]
	[F20-OS1.1] Applies where stucco is applied to masonry <i>chimneys</i> .
	[F20-OS3.4] Applies where stucco is applied to masonry <i>chimneys</i> .
	[F20-OP1.1] Applies where stucco is applied to masonry <i>chimneys</i> .
(4)	[F20-OS2.1]
<b>9.28.5.1. Mixes</b>	
(1)	[F20,F61,F80-OH1.1,OH1.2,OH1.3]
	[F20,F61,F80-OS2.3]
	[F20,F61,F80-OS1.1] Applies where stucco is applied to masonry <i>chimneys</i> .
	[F20,F61,F80-OS3.4] Applies where stucco is applied to masonry <i>chimneys</i> .
	[F20,F61,F80-OP1.1] Applies where stucco is applied to masonry <i>chimneys</i> .
<b>9.28.5.2. Pigments</b>	
(1)	[F20,F80-OH1.1,OH1.2,OH1.3]
	[F20,F80-OS2.3]
	[F20,F80-OS1.1] Applies where stucco is applied to masonry <i>chimneys</i> .
	[F20,F80-OS3.4] Applies where stucco is applied to masonry <i>chimneys</i> .
	[F20,F80-OP1.1] Applies where stucco is applied to masonry <i>chimneys</i> .
(2)	[F20,F80-OH1.1,OH1.2,OH1.3]
	[F20,F80-OS2.3]
<b>9.28.5.3. Mixing</b>	



(1)	[F20,F80-OH1.1,OH1.2,OH1.3]
	[F20,F80-OS2.3]
	[F20,F80-OS1.1] Applies where stucco is applied to masonry <i>chimneys</i> .
	[F20,F80-OS3.4] Applies where stucco is applied to masonry <i>chimneys</i> .
	[F20,F80-OP1.1] Applies where stucco is applied to masonry <i>chimneys</i> .
(2)	[F20,F80-OH1.1,OH1.2,OH1.3]
	[F20,F80-OS2.3]
	[F20,F80-OS1.1] Applies where stucco is applied to masonry <i>chimneys</i> .
	[F20,F80-OS3.4] Applies where stucco is applied to masonry <i>chimneys</i> .
	[F20,F80-OP1.1] Applies where stucco is applied to masonry <i>chimneys</i> .
<b>9.28.6.1. Low Temperature Conditions</b>	
(1)	[F20,F80-OH1.1,OH1.2,OH1.3]
	[F20,F80-OS2.3]
	[F20,F80-OS1.1] Applies where stucco is applied to masonry <i>chimneys</i> .
	[F20,F80-OS3.4] Applies where stucco is applied to masonry <i>chimneys</i> .
	[F20,F80-OP1.1] Applies where stucco is applied to masonry <i>chimneys</i> .
(2)	[F20,F80-OH1.1,OH1.2,OH1.3]
	[F20,F80-OS2.3]
	[F20,F80-OS1.1] Applies where stucco is applied to masonry <i>chimneys</i> .
	[F20,F80-OS3.4] Applies where stucco is applied to masonry <i>chimneys</i> .
	[F20,F80-OP1.1] Applies where stucco is applied to masonry <i>chimneys</i> .
<b>9.28.6.2. Number of Coats and Total Thickness</b>	
(1)	[F20-OH1.1,OH1.2,OH1.3]
	[F20-OS2.3]
	[F20-OS1.1] Applies where stucco is applied to masonry <i>chimneys</i> .
	[F20-OS3.4] Applies where stucco is applied to masonry <i>chimneys</i> .
	[F20-OP1.1] Applies where stucco is applied to masonry <i>chimneys</i> .
<b>9.28.6.3. First Coat</b>	
(1)	[F20,F80-OH1.1,OH1.2,OH1.3]
	[F20,F80-OS2.3]
	[F20,F80-OS1.1] Applies where stucco is applied to masonry <i>chimneys</i> .
	[F20,F80-OS3.4] Applies where stucco is applied to masonry <i>chimneys</i> .
	[F20,F80-OP1.1] Applies where stucco is applied to masonry <i>chimneys</i> .
(2)	[F20-OH1.1,OH1.2,OH1.3]
	[F20-OS2.3]
	[F20-OS1.1] Applies where stucco is applied to masonry <i>chimneys</i> .
	[F20-OS3.4] Applies where stucco is applied to masonry <i>chimneys</i> .

	[F20-OP1.1] Applies where stucco is applied to masonry <i>chimneys</i> .
<b>9.28.6.4. Second Coat</b>	
(1)	[F20-OH1.1,OH1.2,OH1.3]
	[F20-OS2.3]
	[F20-OS1.1] Applies where stucco is applied to masonry <i>chimneys</i> .
	[F20-OS3.4] Applies where stucco is applied to masonry <i>chimneys</i> .
	[F20-OP1.1] Applies where stucco is applied to masonry <i>chimneys</i> .
(2)	[F20-OH1.1,OH1.2,OH1.3]
	[F20-OS2.3]
	[F20-OS1.1] Applies where stucco is applied to masonry <i>chimneys</i> .
	[F20-OS3.4] Applies where stucco is applied to masonry <i>chimneys</i> .
	[F20-OP1.1] Applies where stucco is applied to masonry <i>chimneys</i> .
<b>9.28.6.5. Finish Coat</b>	
(1)	[F80-OH1.1,OH1.2,OH1.3]
	[F80-OS2.3]
	[F80-OS1.1] Applies where stucco is applied to masonry <i>chimneys</i> .
	[F80-OS3.4] Applies where stucco is applied to masonry <i>chimneys</i> .
	[F80-OP1.1] Applies where stucco is applied to masonry <i>chimneys</i> .
(2)	[F20-OH1.1,OH1.2,OH1.3]
	[F20-OS2.3]
	[F20-OS1.1] Applies where stucco is applied to masonry <i>chimneys</i> .
	[F20-OS3.4] Applies where stucco is applied to masonry <i>chimneys</i> .
	[F20-OP1.1] Applies where stucco is applied to masonry <i>chimneys</i> .
(3)	[F80-OH1.1,OH1.2,OH1.3]
	[F80-OS2.3]
	[F80-OS1.1] Applies where stucco is applied to masonry <i>chimneys</i> .
	[F80-OS3.4] Applies where stucco is applied to masonry <i>chimneys</i> .
	[F80-OP1.1] Applies where stucco is applied to masonry <i>chimneys</i> .
<b>9.29.2.1. Where Required</b>	
(1)	[F80,F81-OH1.1,OH1.2] Applies where interior finishes support or serve as required environmental separation elements.
	[F80,F81-OS2.3]
	[F80,F81-OS1.2] Applies where interior finishes are required to act as fire protection for foamed plastics or to contribute to the required fire resistance of assemblies.
	[F80,F81-OP2.3,OP2.4]
<b>9.29.2.2. Materials</b>	
(1)	[F80,F81-OH1.1,OH1.2] Applies where interior finishes support or serve as required environmental separation elements.

	[F80-OS2.3]
	[F80-OS1.2] Applies where interior finishes are required to act as fire protection for foamed plastics or to contribute to the required fire resistance of assemblies.
	[F80-OP2.3,OP2.4]
<b>9.29.3.1. Size and Spacing of Furring</b>	
(1)	[F20,F22-OS2.1]
	[F20,F22-OH1.1,OH1.2] Applies where interior finishes support or serve as required environmental separation elements.
	[F20,F22-OS1.2] Applies where interior finishes are required to act as fire protection for foamed plastics or to contribute to the required fire resistance of assemblies.
	[F20,F22-OP2.1,OP2.4]
<b>9.29.3.2. Fastening</b>	
(1)	[F20-OS2.1]
	[F20-OS1.2] Applies where interior finishes are required to act as fire protection for foamed plastics or to contribute to the required fire resistance of assemblies.
	[F20-OH1.1,OH1.2] Applies where interior finishes support or serve as required environmental separation elements.
	[F20-OP2.1,OP2.4]
<b>9.29.4.1. Application</b>	
(1)	[F20,F80-OS2.1,OS2.3]
	[F20,F22,F80,F81-OH1.1,OH1.2] Applies where interior finishes support or serve as required environmental separation elements.
	[F20,F80-OS1.2] Applies where interior finishes are required to act as fire protection for foamed plastics or to contribute to the required fire resistance of assemblies.
	[F20,F80-OP2.1,OP2.3] [F22,F80-OP2.4]
<b>9.29.5.1. Application</b>	
(2)	[F20,F80-OS2.1,OS2.3]
	[F20,F22,F80,F81-OH1.1,OH1.2] Applies where interior finishes support or serve as required environmental separation elements.
	[F20,F22,F80-OS1.2] Applies where interior finishes are required to act as fire protection for foamed plastics or to contribute to the required fire resistance of assemblies.
	[F20,F80-OP2.1,OP2.3] [F22,F80-OP2.4]
(3)	[F20,F80-OS2.1,OS2.3]
	[F20,F22,F80,F81-OH1.1,OH1.2] Applies where interior finishes support or serve as required environmental separation elements.
	[F20,F22,F80-OS1.2] Applies where interior finishes are required to act as fire protection for foamed plastics or to contribute to the required fire resistance of assemblies.
	[F20,F80-OP2.1,OP2.3] [F22,F80-OP2.4]
<b>9.29.5.2. Materials</b>	
(1)	[F20,F80-OP2.1,OP2.3] [F22,F80-OP2.4]
	[F20,F80-OS2.1,OS2.3]

	[F20,F22,F80-OS1.2] Applies where interior finishes are required to act as fire protection for foamed plastics or to contribute to the required fire resistance of assemblies.
	[F20,F22,F80,F81-OH1.1,OH1.2] Applies where interior finishes support or serve as required environmental separation elements.
<b>9.29.5.3. Maximum Spacing of Supports</b>	
(1)	[F20-OS2.1]
	[F20,F22-OS1.2] Applies where interior finishes are required to act as fire protection for foamed plastics or to contribute to the required fire resistance of assemblies.
	[F20,F22-OH1.1,OH1.2] Applies where interior finishes support or serve as required environmental separation elements.
	[F20-OP2.1] [F20,F22-OP2.4]
<b>9.29.5.4. Support of Insulation</b>	
(1)	[F20-OS2.1]
	[F20,F22-OH1.1,OH1.2] Applies where interior finishes support or serve as required environmental separation elements.
	[F20,F22-OS1.2] Applies where interior finishes are required to act as fire protection for foamed plastics or to contribute to the required fire resistance of assemblies.
	[F20-OP2.1] [F20,F22-OP2.4]
<b>9.29.5.5. Length of Fasteners</b>	
(1)	[F20-OS2.1]
	[F20-OS1.2] Applies where interior finishes are required to act as fire protection for foamed plastics or to contribute to the required fire resistance of assemblies.
	[F20-OH1.1,OH1.2] Applies where interior finishes support or serve as required environmental separation elements.
	[F20-OP2.1,OP2.4]
<b>9.29.5.6. Nails</b>	
(1)	[F20-OS2.1]
	[F20-OS1.2] Applies where interior finishes are required to act as fire protection for foamed plastics or to contribute to the required fire resistance of assemblies.
	[F20-OH1.1,OH1.2] Applies where interior finishes support or serve as required environmental separation elements.
	[F20-OP2.1,OP2.4]
<b>9.29.5.7. Screws</b>	
(1)	[F20-OS2.1]
	[F20-OS1.2] Applies where interior finishes are required to act as fire protection for foamed plastics or to contribute to the required fire resistance of assemblies.
	[F20-OH1.1,OH1.2] Applies where interior finishes support or serve as required environmental separation elements.
	[F20-OP2.1,OP2.4]
<b>9.29.5.8. Spacing of Nails</b>	
(1)	[F20-OP2.1] [F20-OP2.3] Applies where interior finishes support or serve as required environmental separation elements.

	<p>[F20-OS2.1] [F20-OS2.3] Applies where interior finishes support or serve as required environmental separation elements.</p>
	<p>[F20-OH1.1,OH1.2] Applies where interior finishes support or serve as required environmental separation elements.</p>
	<p>[F20-OS1.2] Applies where interior finishes are required to act as fire protection for foamed plastics or to contribute to the required fire resistance of assemblies.</p>
	<p>[F20-OP1.2] Applies where interior finishes are required to act as fire protection for foamed plastics or to contribute to the required fire resistance of assemblies.</p>
(3)	<p>[F20-OS2.1] [F20-OS2.3] Applies where interior finishes support or serve as required environmental separation elements.</p>
	<p>[F20-OP2.1] [F20-OP2.3] Applies where interior finishes support or serve as required environmental separation elements.</p>
	<p>[F20-OH1.1,OH1.2] Applies where interior finishes support or serve as required environmental separation elements.</p>
(4)	<p>[F20-OS2.1] [F20-OS2.5] [F22-OS2.4,OS2.5] Applies where interior finishes contribute to the required bracing or lateral support for studs. [F20,F22-OS2.3] Applies where interior finishes support or serve as required environmental separation elements.</p>
	<p>[F20-OP2.1] [F20-OP2.5] [F22-OP2.4,OP2.5] Applies where interior finishes contribute to the required bracing or lateral support for studs. [F20,F22-OP2.3] Applies where interior finishes support or serve as required environmental separation elements.</p>
	<p>[F20,F22-OH1.1,OH1.2,OH1.3] Applies where interior finishes contribute to the required bracing or lateral support for studs, or where interior finishes support or serve as required environmental separation elements.</p>
	<p>[F20-OS1.2] Applies where interior finishes are required to act as fire protection for foamed plastics or contribute to the required fire resistance of assemblies.</p>
	<p>[F20,F22-OH4] Applies where walls support floors and where interior finishes contribute to the required bracing or lateral support for studs or where interior finishes support or serve as required environmental separation elements.</p>
	<p>[F20,F22-OS3.1,OS3.7] Applies where walls support floors and where interior finishes contribute to the required bracing or lateral support for studs or where interior finishes support or serve as required environmental separation elements.</p>
	<p>[F20-OP3.1] Applies where interior finishes are installed to contribute to the required fire resistance of exterior walls.</p>
	<p>[F20-OP1.2] Applies where interior finishes are required to act as fire protection for foamed plastics or contribute to the required fire resistance of assemblies.</p>
(5)	<p>[F20-OS2.1] [F20-OS2.5] [F22-OS2.4,OS2.5] Applies where interior finishes contribute to the required bracing or lateral support for studs. [F20,F22-OS2.3] Applies where interior finishes support or serve as required environmental separation elements.</p>
	<p>[F20-OP2.1] [F20-OP2.5] [F22-OP2.4,OP2.5] Applies where interior finishes contribute to the required bracing or lateral support for studs.</p>

	[F20,F22-OP2.3] Applies where interior finishes support or serve as required environmental separation elements.
	[F20,F22-OH1.1,OH1.2,OH1.3] Applies where interior finishes contribute to the required bracing or lateral support for studs, or where interior finishes support or serve as required environmental separation elements.
	[F20-OH4] Applies where walls support floors and where interior finishes contribute to the required bracing or lateral support for studs or where interior finishes support or serve as required environmental separation elements.
	[F20-OS3.1,OS3.7] Applies where walls support floors and where interior finishes contribute to the required bracing or lateral support for studs or where interior finishes support or serve as required environmental separation elements.
	[F20-OS1.2] Applies where interior finishes are required to act as fire protection for foamed plastics or to contribute to the required fire resistance of assemblies.
	[F20-OP1.2] Applies where interior finishes are required to act as fire protection for foamed plastics or to contribute to the required fire resistance of assemblies.
	[F20-OP3.1] Applies where interior finishes are installed to contribute to the required fire resistance of exterior walls.
(6)	[F20-OS2.1] [F20-OS2.5] [F22-OS2.4,OS2.5] Applies where interior finishes contribute to the required bracing or lateral support for studs. [F20,F22-OS2.3] Applies where interior finishes support or serve as required environmental separation elements.
	[F20-OS1.2] Applies where interior finishes are required to act as fire protection for foamed plastics or to contribute to the required fire resistance of assemblies.
	[F20,F22-OH1.1,OH1.2,OH1.3] Applies where interior finishes support or serve as required environmental separation elements.
	[F20-OP2.1] [F20-OP2.5] [F22-OP2.4,OP2.5] Applies where interior finishes contribute to the required bracing or lateral support for studs. [F20,F22-OP2.3] Applies where interior finishes support or serve as required environmental separation elements.
	[F20-OH4] Applies where walls support floors and where interior finishes contribute to the required bracing or lateral support for studs or where interior finishes support or serve as required environmental separation elements.
	[F20-OP1.2] Applies where interior finishes are required to act as fire protection for foamed plastics or to contribute to the required fire resistance of assemblies.
	[F20-OS3.1,OS3.7] Applies where walls support floors and where interior finishes contribute to the required bracing or lateral support for studs or where interior finishes support or serve as required environmental separation elements.
(7)	[F20-OS2.1] [F20-OS2.5] [F22-OS2.4,OS2.5] Applies where interior finishes contribute to the required bracing or lateral support for studs. [F20,F22-OS2.3] Applies where interior finishes support or serve as required environmental separation elements.
	[F20-OP2.1] [F20-OP2.5] [F22-OP2.4,OP2.5] Applies where interior finishes contribute to the required bracing or lateral support for studs. [F20,F22-OP2.3] Applies where interior finishes support or serve as required environmental separation elements.

	[F20,F22-OH1.1,OH1.2,OH1.3] Applies where interior finishes contribute to the required bracing or lateral support for studs, or where interior finishes support or serve as required environmental separation elements.
	[F20-OH4] Applies where walls support floors and where interior finishes contribute to the required bracing or lateral support for studs or where interior finishes support or serve as required environmental separation elements.
	[F20-OS3.1,OS3.7] Applies where walls support floors and where interior finishes contribute to the required bracing or lateral support for studs or where interior finishes support or serve as required environmental separation elements.
	[F20-OS1.2] Applies where interior finishes are required to act as fire protection for foamed plastics or to contribute to the required fire resistance of assemblies.
	[F20-OP1.2] Applies where interior finishes are required to act as fire protection for foamed plastics or to contribute to the required fire resistance of assemblies.
	[F20-OP3.1] Applies where interior finishes are installed to contribute to the required fire resistance of exterior walls.
<b>9.29.5.9. Spacing of Screws</b>	
(1)	[F20-OS2.1] [F20-OS2.3] Applies where interior finishes support or serve as required environmental separation elements.
	[F20-OP2.1] [F20-OP2.3] Applies where interior finishes support or serve as required environmental separation elements.
	[F20-OH1.1,OH1.2] Applies where interior finishes support or serve as required environmental separation elements.
	[F20-OS1.2] Applies where interior finishes are required to act as fire protection for foamed plastics or to contribute to the required fire resistance of assemblies.
	[F20-OP1.2] Applies where interior finishes are required to act as fire protection for foamed plastics or to contribute to the required fire resistance of assemblies.
(3)	[F20-OS2.1] [F20-OS2.3] Applies where interior finishes support or serve as required environmental separation elements.
	[F20-OP2.1] [F20-OP2.3] Applies where interior finishes support or serve as required environmental separation elements.
	[F20-OH1.1,OH1.2,OH1.3] Applies where interior finishes support or serve as required environmental separation elements.
	[F20-OS1.2] Applies where gypsum board is required to provide the fire resistance and the rating of the assembly is determined according to Table 9.10.3.1.-A.
	[F20-OP1.2] Applies where gypsum board is required to provide the fire resistance and the rating of the assembly is determined according to Table 9.10.3.1.-A.
	[F20-OP3.1] Applies where interior finishes are installed to contribute to the required fire resistance of exterior walls.
(4)	[F20-OS2.1] [F20-OS2.5] [F22-OS2.4,OS2.5] Applies where interior finishes contribute to the required bracing or lateral support for studs. [F20,F22-OS2.3] Applies where interior finishes support or serve as required environmental separation elements.
	[F20-OP2.1] [F20-OP2.5] [F22-OP2.4,OP2.5] Applies where interior finishes contribute to the required bracing or

	<p>lateral support for studs. [F20,F22-OP2.3] Applies where interior finishes support or serve as required environmental separation elements.</p> <p>[F20,F22-OH1.1,OH1.2,OH1.3] Applies where interior finishes contribute to the required bracing or lateral support for studs, or where interior finishes support or serve as required environmental separation elements.</p> <p>[F20-OS1.2] Applies where interior finishes are required to act as fire protection for foamed plastics or contribute to the required fire resistance of assemblies.</p> <p>[F20,F22-OS3.1,OS3.7] Applies where the walls support floors and where interior finishes contribute to the required bracing or lateral support for studs or where interior finishes support or serve as required environmental separation elements.</p> <p>[F20,F22-OH4] Applies where the walls support floors and where interior finishes contribute to the required bracing or lateral support for studs or where interior finishes support or serve as required environmental separation elements.</p> <p>[F20-OP3.1] Applies where interior finishes are installed to contribute to the required fire resistance of exterior walls.</p> <p>[F20-OP1.2] Applies where interior finishes are required to act as fire protection for foamed plastics or to contribute to the required fire resistance of assemblies.</p>
(6)	<p>[F20-OS2.1] [F20-OS2.5] [F22-OS2.4,OS2.5] Applies where interior finishes contribute to the required bracing or lateral support for studs. [F20,F22-OS2.3] Applies where interior finishes support or serve as required environmental separation elements.</p> <p>[F20-OP2.1] [F20-OP2.5] [F22-OP2.4,OP2.5] Applies where interior finishes contribute to the required bracing or lateral support for studs. [F20,F22-OP2.3] Applies where interior finishes support or serve as required environmental separation elements.</p> <p>[F20,F22-OH1.1,OH1.2,OH1.3] Applies where interior finishes contribute to the required bracing or lateral support for studs, or where interior finishes support or serve as required environmental separation elements.</p> <p>[F20-OH4] Applies where walls support floors and where interior finishes contribute to the required bracing or lateral support for studs or where interior finishes support or serve as required environmental separation elements.</p> <p>[F20-OS3.1,OS3.7] Applies where walls support floors and where interior finishes contribute to the required bracing or lateral support for studs or where interior finishes support or serve as required environmental separation elements.</p> <p>[F20-OS1.2] Applies where interior finishes are required to act as fire protection for foamed plastics or to contribute to the required fire resistance of assemblies.</p> <p>[F20-OP1.2] Applies where interior finishes are required to act as fire protection for foamed plastics or to contribute to the required fire resistance of assemblies.</p> <p>[F20-OP3.1] Applies where interior finishes are installed to contribute to the required fire resistance of exterior walls.</p>
(7)	<p>[F20-OS2.1] [F20-OS2.5] [F22-OS2.4,OS2.5] Applies where interior finishes contribute to the required bracing or lateral support for studs. [F20,F22-OS2.3] Applies where interior finishes support or serve as required environmental separation elements.</p> <p>[F20-OP2.1] [F20-OP2.5] [F22-OP2.4,OP2.5] Applies where interior finishes contribute to the required bracing or lateral support for studs.</p>



	[F20,F22-OP2.3] Applies where interior finishes support or serve as required environmental separation elements.
	[F20,F22-OH1.1,OH1.2,OH1.3] Applies where interior finishes contribute to the required bracing or lateral support for studs, or where interior finishes support or serve as required environmental separation elements.
	[F20-OS3.1,OS3.7] Applies where walls support floors and where interior finishes contribute to the required bracing or lateral support for studs or where interior finishes support or serve as required environmental separation elements.
	[F20-OS1.2] Applies where interior finishes are required to act as fire protection for foamed plastics or to contribute to the required fire resistance of assemblies.
	[F20-OH4] Applies where walls support floors and where interior finishes contribute to the required bracing or lateral support for studs or where interior finishes support or serve as required environmental separation elements.
	[F20-OP1.2] Applies where interior finishes are required to act as fire protection for foamed plastics or to contribute to the required fire resistance of assemblies.
	[F20-OP3.1] Applies where interior finishes are installed to contribute to the required fire resistance of exterior walls.
<b>9.29.5.10. Low Temperature Conditions</b>	
(1)	[F81-OS1.2] Applies where the finishing of joints is required to maintain required <i>fire-resistance ratings</i> .
<b>9.29.6.1. Thickness</b>	
(1)	[F20-OS2.1]
	[F20,F22-OS1.2] Applies where interior finishes are required to act as fire protection for foamed plastics or to contribute to the required fire resistance of assemblies.
	[F20,F22-OH1.1,OH1.2] Applies where interior finishes support or serve as required environmental separation elements.
	[F20-OP2.1] [F20,F22-OP2.4]
<b>9.29.6.2. Grooved Plywood</b>	
(1)	[F20-OS2.1]
	[F20,F22-OS1.2] Applies where interior finishes are required to act as fire protection for foamed plastics or to contribute to the required fire resistance of assemblies.
	[F20,F22-OH1.1,OH1.2] Applies where interior finishes support or serve as required environmental separation elements.
	[F20-OP2.1] [F20,F22-OP2.4]
<b>9.29.6.3. Nails and Staples</b>	
(1)	[F20-OS2.1]
	[F20,F22-OS1.2] Applies where interior finishes are required to act as fire protection for foamed plastics or to contribute to the required fire resistance of assemblies.
	[F20,F22-OH1.1,OH1.2] Applies where interior finishes support or serve as required environmental separation elements.
	[F20-OP2.1] [F20,F22-OP2.4]
(2)	[F20-OS2.1,OS2.3,OS2.5] [F22-OS2.3,OS2.4,OS2.5]
	[F20-OP2.1,OP2.3,OP2.5] [F22-OP2.3,OP2.4,OP2.5]
	[F20,F22-OS1.2] Applies to assemblies required to provide fire resistance.

	[F22-OS3.1] Applies to walls that support floors. [F22-OS3.7] Applies to walls that contain doors or windows required for emergency egress.
	[F20,F22-OH4] Applies to walls that support floors.
	[F20,F22-OH1.1,OH1.2,OH1.3] Applies to elements that support or are part of an environmental separator.
<b>9.29.6.4. Edge Support</b>	
(1)	[F20-OS2.1]
	[F20,F22-OS1.2] Applies where interior finishes are required to act as fire protection for foamed plastics or to contribute to the required fire resistance of assemblies.
	[F20,F22-OH1.1,OH1.2] Applies where interior finishes support or serve as required environmental separation elements.
	[F20-OP2.1] [F20,F22-OP2.4]
<b>9.29.7.1. Material Standard</b>	
(1)	[F20,F80-OS2.1,OS2.3]
	[F20,F22,F80-OS1.2] Applies where interior finishes are required to act as fire protection for foamed plastics or to contribute to the required fire resistance of assemblies.
	[F20,F22,F80,F81-OH1.1,OH1.2] Applies where interior finishes support or serve as required environmental separation elements.
	[F20,F80-OP2.1,OP2.3] [F22,F80-OP2.4]
<b>9.29.7.2. Thickness</b>	
(1)	[F20-OS2.1]
	[F20,F22-OS1.2] Applies where interior finishes are required to act as fire protection for foamed plastics or to contribute to the required fire resistance of assemblies.
	[F20,F22-OH1.1,OH1.2] Applies where interior finishes support or serve as required environmental separation elements.
	[F20-OP2.1] [F20,F22-OP2.4]
<b>9.29.7.3. Nails</b>	
(1)	[F20-OS2.1]
	[F20,F22-OS1.2] Applies where interior finishes are required to act as fire protection for foamed plastics or to contribute to the required fire resistance of assemblies.
	[F20,F22-OH1.1,OH1.2] Applies where interior finishes support or serve as required environmental separation elements.
	[F20-OP2.1] [F20,F22-OP2.4]
<b>9.29.7.4. Edge Support</b>	
(1)	[F20-OS2.1]
	[F20,F22-OH1.1,OH1.2] Applies where interior finishes support or serve as required environmental separation elements.
	[F20,F22-OS1.2] Applies where interior finishes are required to act as fire protection for foamed plastics or to contribute to the required fire resistance of assemblies.
	[F20-OP2.1] [F20,F22-OP2.4]
<b>9.29.8.1. Material Standard</b>	
(1)	[F20,F80-OS2.1,OS2.3]

	[F20,F22,F80-OS1.2] Applies where interior finishes are required to act as fire protection for foamed plastics or to contribute to the required fire resistance of assemblies.
	[F20,F22,F80,F81-OH1.1,OH1.2] Applies where interior finishes support or serve as required environmental separation elements.
	[F20,F80-OP2.1,OP2.3]
<b>9.29.8.2. Thickness</b>	
(1)	[F20-OS2.1]
	[F20,F22-OS1.2] Applies where interior finishes are required to act as fire protection for foamed plastics or to contribute to the required fire resistance of assemblies.
	[F20,F22-OH1.1,OH1.2] Applies where interior finishes support or serve as required environmental separation elements.
	[F20-OP2.1] [F20,F22-OP2.4]
(2)	[F20-OS2.1]
	[F20,F22-OS1.2] Applies where interior finishes are required to act as fire protection for foamed plastics or to contribute to the required fire resistance of assemblies.
	[F20,F22-OH1.1,OH1.2] Applies where interior finishes support or serve as required environmental separation elements.
	[F20-OP2.1] [F20,F22-OP2.4]
<b>9.29.8.3. Nails</b>	
(1)	[F20-OS2.1]
	[F20-OS1.2] Applies where interior finishes are required to act as fire protection for foamed plastics or to contribute to the required fire resistance of assemblies.
	[F20-OH1.1,OH1.2] Applies where interior finishes support or serve as required environmental separation elements.
	[F20-OP2.1] [F20-OP2.4]
(2)	[F20-OS2.1]
	[F20,F22-OS1.2] Applies where interior finishes are required to act as fire protection for foamed plastics or to contribute to the required fire resistance of assemblies.
	[F20,F22-OH1.1,OH1.2] Applies where interior finishes support or serve as required environmental separation elements.
	[F20-OP2.1] [F20,F22-OP2.4]
<b>9.29.8.4. Edge Support</b>	
(1)	[F20-OS2.1]
	[F20,F22-OH1.1,OH1.2] Applies where interior finishes support or serve as required environmental separation elements.
	[F20,F22-OS1.2] Applies where interior finishes are required to act as fire protection for foamed plastics or to contribute to the required fire resistance of assemblies.
	[F20-OP2.1] [F20,F22-OP2.4]
<b>9.29.9.1. Material Standard</b>	
(1)	[F20,F80-OS2.1,OS2.3]
	[F20,F22,F80-OS1.2] Applies where interior finishes are required to act as fire protection for foamed plastics or to contribute to the required fire resistance of assemblies.

	[F20,F22,F80,F81-OH1.1,OH1.2] Applies where interior finishes support or serve as required environmental separation elements.
	[F20,F80-OP2.1,OP2.3] [F22,F80-OP2.4]
(2)	[F20,F80-OP2.1,OP2.3] [F22,F80-OP2.4]
	[F20,F80-OS2.1,OS2.3]
	[F20,F22,F80-OS1.2] Applies where interior finishes are required to act as fire protection for foamed plastics or to contribute to the required fire resistance of assemblies.
	[F20,F22,F80,F81-OH1.1,OH1.2] Applies where interior finishes support or serve as required environmental separation elements.
<b>9.29.9.2. Minimum Thickness</b>	
(1)	[F20-OS2.1]
	[F20,F22-OS1.2] Applies where interior finishes are required to act as fire protection for foamed plastics or to contribute to the required fire resistance of assemblies.
	[F20,F22-OH1.1,OH1.2] Applies where interior finishes support or serve as required environmental separation elements.
	[F20-OP2.1] [F20,F22-OP2.4]
(4)	[F20-OS2.1]
	[F20,F22-OS1.2] Applies where interior finishes are required to act as fire protection for foamed plastics or to contribute to the required fire resistance of assemblies.
	[F20,F22-OH1.1,OH1.2] Applies where interior finishes support or serve as required environmental separation elements.
	[F20-OP2.1] [F20,F22-OP2.4]
(5)	[F20-OS2.1] [F20,F22-OS2.4,OS2.5] Applies where interior finishes contribute to the required bracing or lateral support for studs. [F20,F22-OS2.3] Applies where interior finishes support or serve as required environmental separation elements.
	[F20-OP2.1] [F20-OP2.5] [F22-OP2.4,OP2.5] Applies where interior finishes contribute to the required bracing or lateral support for studs. [F20,F22-OP2.3] Applies where interior finishes support or serve as required environmental separation elements.
	[F20,F22-OH1.1,OH1.2,OH1.3] Applies where interior finishes support or serve as required environmental separation elements, or where interior finishes contribute to the required bracing of exterior walls.
	[F20,F22-OS1.2] Applies where interior finishes are required to act as fire protection for foamed plastics.
<b>9.29.9.3. Nails</b>	
(1)	[F20-OS2.1]
	[F20,F22-OS1.2] Applies where interior finishes are required to act as fire protection for foamed plastics or to contribute to the required fire resistance of assemblies.
	[F20,F22-OH1.1,OH1.2] Applies where interior finishes support or serve as required environmental separation elements.
	[F20-OP2.1] [F20,F22-OP2.4]
(2)	[F20-OS2.1,OS2.3,OS2.5] [F22-OS2.3,OS2.4,OS2.5]
	[F20-OP2.1,OP2.3,OP2.5] [F22-OP2.3,OP2.4,OP2.5]

	[F20,F22-OS1.2] Applies to assemblies required to provide fire resistance.
	[F22-OS3.1] Applies to walls that support floors. [F22-OS3.7] Applies to walls that contain doors or windows required for emergency egress.
	[F20,F22-OH4] Applies to walls that support floors.
	[F20,F22-OH1.1,OH1.2,OH1.3] Applies to elements that support or are part of an environmental separator.
<b>9.29.9.4. Edge Support</b>	
(1)	[F20-OS2.1]
	[F20,F22-OH1.1,OH1.2] Applies where interior finishes support or serve as required environmental separation elements.
	[F20,F22-OS1.2] Applies where interior finishes are required to act as fire protection for foamed plastics or to contribute to the required fire resistance of assemblies.
	[F20-OP2.1] [F20,F22-OP2.4]
<b>9.29.10.1. Tile Application</b>	
(1)	[F20,F81-OH1.1,OH1.2] Applies where the substrate serves as a required environmental separation element.
	[F20-OS2.1] [F20-OS2.5] [F22-OS2.4,OS2.5] Applies where the substrate for the tile contributes to the required bracing or lateral support for studs. [F20-OS2.3] Applies where the substrate for the tile serves as a required environmental separation element or where the tile is installed to provide the required waterproof wall finish.
	[F20-OS1.2] Applies where the substrate is required to act as fire protection for foamed plastics or to contribute to the required fire resistance of assemblies.
	[F20-OP2.1] [F20-OP2.5] [F22-OP2.4,OP2.5] Applies where the substrate for the tile contributes to the required bracing or lateral support for studs. [F20-OP2.3] Applies where the substrate for the tile serves as a required environmental separation element or where the tile is installed to provide the required waterproof wall finish.
(2)	[F20,F81-OH1.1,OH1.2] Applies where the substrate serves as a required environmental separation element.
	[F20-OS2.1] [F20-OS2.5] [F22-OS2.4,OS2.5] Applies where the substrate for the tile contributes to the required bracing or lateral support for studs. [F20-OS2.3] Applies where the substrate for the tile serves as a required environmental separation element or where the tile is installed to provide the required waterproof wall finish.
	[F20-OS1.2] Applies where the substrate is required to act as fire protection for foamed plastics or to contribute to the required fire resistance of assemblies.
	[F20-OP2.1] [F20-OP2.5] [F22-OP2.4,OP2.5] Applies where the substrate for the tile contributes to the required bracing or lateral support for studs. [F20-OP2.3] Applies where the substrate for the tile serves as a required environmental separation element or where the tile is installed to provide the required waterproof wall finish.
<b>9.29.10.2. Mortar Base</b>	
(1)	[F20-OS2.1] [F20-OS2.5] [F22-OS2.4,OS2.5] Applies where the substrate for the tile contributes to the required bracing or lateral support for studs. [F20,F80-OS2.3] Applies where the substrate for the tile serves as a required environmental separation element or where the tile is installed to provide the required waterproof wall finish.

	[F20,F80-OS1.2] Applies where the substrate is required to act as fire protection for foamed plastics or to contribute to the required fire resistance of assemblies.
	[F20,F80,F81-OH1.1,OH1.2] Applies where the substrate serves as a required environmental separation element.
	[F20-OP2.1] [F20-OP2.5] [F22-OP2.4,OP2.5] Applies where the substrate for the tile contributes to the required bracing or lateral support for studs. [F20-OP2.3] Applies where the substrate for the tile serves as a required environmental separation element or where the tile is installed to provide the required waterproof wall finish.
(2)	[F20-OS2.1] [F20-OS2.5] [F22-OS2.4,OS2.5] Applies where the substrate for the tile contributes to the required bracing or lateral support for studs. [F20,F80-OS2.3] Applies where the substrate for the tile serves as a required environmental separation element or where the tile is installed to provide the required waterproof wall finish.
	[F20,F80-OS1.2] Applies where the substrate is required to act as fire protection for foamed plastics or to contribute to the required fire resistance of assemblies.
	[F20,F80,F81-OH1.1,OH1.2] Applies where the substrate serves as a required environmental separation element.
	[F20-OP2.1] [F20-OP2.5] [F22-OP2.4,OP2.5] Applies where the substrate for the tile contributes to the required bracing or lateral support for studs. [F20-OP2.3] Applies where the substrate for the tile serves as a required environmental separation element or where the tile is installed to provide the required waterproof wall finish.
(3)	[F20-OS2.1] [F20-OS2.5] [F22-OS2.4,OS2.5] Applies where the substrate for the tile contributes to the required bracing or lateral support for studs. [F20-OS2.3] Applies where the substrate for the tile serves as a required environmental separation element.
	[F20-OS1.2] Applies where the substrate is required to act as fire protection for foamed plastics or to contribute to the required fire resistance of assemblies.
	[F20,F81-OH1.1,OH1.2] Applies where the substrate serves as a required environmental separation element.
	[F20-OP2.1] [F20-OP2.5] [F22-OP2.4,OP2.5] Applies where the substrate for the tile contributes to the required bracing or lateral support for studs. [F20-OP2.3] Applies where the substrate for the tile serves as a required environmental separation element or where the tile is installed to provide the required waterproof wall finish.
(4)	[F20-OS2.1] [F20-OS2.5] [F22-OS2.4,OS2.5] Applies where the substrate for the tile contributes to the required bracing or lateral support for studs. [F20-OS2.3] Applies where the substrate for the tile serves as a required environmental separation element or where the tile is installed to provide the required waterproof wall finish.
	[F20-OH1.1,OH1.2] Applies where the substrate serves as a required environmental separation element.
	[F20-OS1.2] Applies where the substrate is required to act as fire protection for foamed plastics or to contribute to the required fire resistance of assemblies.
	[F20-OP2.1] [F20-OP2.5] [F22-OP2.4,OP2.5] Applies where the substrate for the tile contributes to the required bracing or lateral support for studs. [F20-OP2.3] Applies where the substrate for the tile serves as a required environmental separation element or where the tile is installed to provide the required waterproof wall finish.
<b>9.29.10.3. Adhesives</b>	

(1)	[F20-OH1.1,OH1.2] Applies where the substrate serves as a required environmental separation element.
	[F20-OS2.3]
	[F20-OS1.2] Applies where the substrate is required to act as fire protection for foamed plastics or to contribute to the required fire resistance of assemblies.
	[F20-OP2.3,OP2.4]
<b>9.29.10.4. Moisture-Resistant Backing</b>	
(1)	[F81-OH1.1,OH1.2] Applies where the substrate supports or serves as a required environmental separation element.
	[F20-OS2.3]
	[F20-OS1.2] Applies where the substrate is required to act as fire protection for foamed plastics or to contribute to the required fire resistance of assemblies.
	[F81-OP2.3,OP2.4]
<b>9.29.10.5. Joints between Tiles and Bathtub</b>	
(1)	[F81-OH1.1,OH1.2] Applies where the substrate serves as a required environmental separation element.
	[F81-OS2.3]
	[F81-OS1.2] Applies where the substrate is required to act as fire protection for foamed plastics or to contribute to the required fire resistance of assemblies.
	[F81-OP2.3,OP2.4]
<b>9.30.1.1. Required Finished Flooring</b>	
(1)	[F30-OS3.1]
	[F40,F41-OH2.4]
<b>9.30.1.2. Water Resistance</b>	
(1)	[F80-OS2.3] Applies where finished flooring is required to provide water resistance.
	[F41,F81-OH1.1] Applies where finished flooring is required to provide water resistance.
<b>9.30.1.3. Sleepers</b>	
(1)	[F20,F80-OS3.1]
	[F80-OH1.1] Applies to portion of Code text: "Wood sleepers supporting finished flooring over a concrete base supported on the ground ... shall be treated with a wood preservative."
<b>9.30.2.1. Required Underlay</b>	
(1)	[F81-OS3.1]
	[F81-OS2.3] Applies where finished flooring is required to provide water resistance.
	[F81-OH1.1] Applies where finished flooring is required to provide water resistance.
(2)	[F81-OS3.1]
	[F81-OS2.3] Applies where finished flooring is required to provide water resistance.
	[F81-OH1.1] Applies where finished flooring is required to provide water resistance.
(3)	[F81-OS3.1]
	[F81-OH1.1] Applies where finished flooring is required to provide water resistance.
	[F81-OS2.3] Applies where finished flooring is required to provide water resistance.
<b>9.30.2.2. Materials and Thickness</b>	

(1)	[F81-OS3.1]
	[F81-OS2.3] Applies where finished flooring is required to provide water resistance.
	[F81-OH1.1] Applies where finished flooring is required to provide water resistance.
(2)	[F81-OS2.3] Applies where finished flooring is required to provide water resistance.
	[F81-OS3.1]
	[F81-OH1.1] Applies where finished flooring is required to provide water resistance.
<b>9.30.2.3. Fastening</b>	
(1)	[F81-OS3.1]
	[F81-OS2.3] Applies where finished flooring is required to provide water resistance.
	[F81-OH1.1] Applies where finished flooring is required to provide water resistance.
(2)	[F81-OS3.1]
	[F81-OS2.3] Applies where finished flooring is required to provide water resistance.
	[F81-OH1.1] Applies where finished flooring is required to provide water resistance.
(3)	[F81-OS3.1]
	[F81-OS2.3] Applies where finished flooring is required to provide water resistance.
	[F81-OH1.1] Applies where finished flooring is required to provide water resistance.
<b>9.30.2.4. Joints Offset</b>	
(1)	[F81-OS3.1]
	[F81-OS2.3] Applies where finished flooring is required to provide water resistance.
	[F81-OH1.1] Applies where finished flooring is required to provide water resistance.
<b>9.30.2.5. Surface Defects</b>	
(1)	[F81-OS3.1]
	[F81-OS2.3] Applies where finished flooring is required to provide water resistance.
	[F81-OH1.1] Applies where finished flooring is required to provide water resistance.
<b>9.30.3.1. Thickness</b>	
(1)	[F30-OS3.1]
	[F20-OS2.1]
<b>9.30.3.2. Strip Direction and End Joints</b>	
(1)	[F30-OS3.1]
(2)	[F20-OS2.1]
(3)	[F20-OS2.1]
<b>9.30.3.3. Nailing</b>	
(1)	[F30-OS3.1]
(2)	[F30-OS3.1]
<b>9.30.3.4. Staples</b>	
(1)	[F30-OS3.1]
<b>9.30.4.1. Adhesive</b>	



(1)	[F81-OS3.1]
<b>9.30.5.1. Materials</b>	
(1)	[F41,F80-OH1.1]
	[F80-OS3.1]
(2)	[F81,F80-OS3.1]
	[F41-OH1.1]
<b>9.30.6.1. Substrate</b>	
(1)	[F81-OS3.1]
	[F81-OH1.1] Applies where finished flooring is required to provide water resistance.
	[F81-OS2.3] Applies where finished flooring is required to provide water resistance.
(2)	[F81-OH1.1] Applies where finished flooring is required to provide water resistance.
	[F81-OS3.1]
	[F81-OS2.3] Applies where finished flooring is required to provide water resistance.
<b>9.31.2.2. Corrosion Protection</b>	
(1)	[F80-OH2.1]
	[F80-OS2.3]
<b>9.31.2.3. Grab Bars</b>	
(1)	[F20-OS3.1]
<b>9.31.3.1. Required Water Supply</b>	
(1)	[F70,F71-OH2.2,OH2.3]
<b>9.31.3.2. Required Connections</b>	
(1)	[F71-OH2.3]
(2)	[F71,F70-OH2.3]
<b>9.31.4.1. Required Fixtures</b>	
(1)	[F71,F70,F72-OH2.1,OH2.3]
<b>9.31.4.2. Hot Water Supply</b>	
(1)	[F71-OH2.3]
<b>9.31.4.3. Floor Drains</b>	
(1)	[F62,F40,F41-OH1.2,OH1.3] [F62-OH1.1]
(2)	[F62,F52-OH1.2,OH1.3] [F62-OH1.1]
<b>9.31.5.1. Building Sewer</b>	
(1)	[F72-OH2.1]
<b>9.31.5.2. Discharge of Sewage</b>	
(1)	[F72-OH2.1]
(2)	[F72-OH2.1]
<b>9.31.6.1. Hot Water Supply</b>	
(1)	(a) [F40-OH2.1,OH2.4] [F71-OH2.3]

<b>9.31.6.2. Equipment and Installation</b>	
(1)	[F31,F30,F81-OS3.2] [F44-OS3.4]
(2)	[F44-OH1.1]
	[F01-OS1.1]
(3)	[F23-OS3.4]
	[F01-OS1.1]
<b>9.31.6.3. Corrosion-Resistant Coating</b>	
(1)	[F81,F80-OH2.3]
<b>9.31.6.4. Fuel-Burning Heaters</b>	
(1)	[F41-OH1.1]
	[F01-OS1.1]
<b>9.31.6.5. Heating Coils</b>	
(1)	[F31-OS3.2]
	[F71-OH2.3]
<b>9.32.1.2. Required Ventilation</b>	
(1)	[F40,F50,F52-OH1.1] [F51,F52-OH1.2] [F51,F52,F62,F63-OH1.3]
	[F52,F62,F63,F80-OP2.3]
<b>9.32.1.3. Venting of Laundry-Drying Equipment</b>	
(1)	[F50,F44,F40-OH1.1]
	[F52,F50-OH1.1]
	[F44-OS3.4]
	[F01-OS1.1]
	[F01-OP1.1]
(2)	[F81-OS1.1]
(3)	[F44,F50,F40-OH1.1]
	[F52,F50-OH1.1]
	[F44-OS3.4]
	[F01-OS1.1]
	[F01-OP1.1]
<b>9.32.2.1. Required Ventilation</b>	
(1)	[F40,F50,F52-OH1.1] [F51,F52-OH1.2] [F51,F52,F62,F63-OH1.3]
	[F52,F62,F63,F80-OP2.3]
(2)	[F40,F50-OH1.1] [F51,F52-OH1.2] [F51,F52,F62,F63-OH1.3]
	[F52,F62,F63,F80-OP2.3]
<b>9.32.2.2. Non-Heating-Season Natural Ventilation</b>	
(1)	[F40,F50-OH1.1] [F51,F52-OH1.2] [F51,F52,F62,F63-OH1.3]
	[F52,F62,F63,F80-OP2.3]

(3)	[F42-OH2.5]
	[F61,F42-OP2.3]
	Reserved
(4)	[F80-OH2.5]
	[F80-OP2.3,]
<b>9.32.3.1. Required Ventilation</b>	
(1)	[F40,F50,F52-OH1.1] [F51,F52-OH1.2] [F51,F52,F62,F63-OH1.3]
	[F52,F62,F63,F80-OP2.3]
<b>9.32.3.2. Design and Installation</b>	
(1)	[F81-OH1.1,OH1.2,OH1.3]
	[F81-OP2.3]
(2)	[F82-OH1.1,OH1.2,OH1.3]
(3)	[F82-OH1.1,OH1.2,OH1.3]
	[F82-OP2.3]
<b>9.32.3.3. Mechanical Ventilation System Components</b>	
(1)	(a) [F40,F41,F50-OH1.1]
	(a), (b) [F52-OH1.2]
	(a), (b) [F40,F52,F62,F63,F80-OH1.3]
	(a), (b) [F40,F52,F62,F63,F80-OP2.3]
<b>9.32.3.4. Principal Ventilation System Supply Air</b>	
(2)	[F40,F41,F50-OH1.1]
	Reserved
(3)	[F40,F41,F50-OH1.1]
	Reserved
(4)	[F40,F41,F50-OH1.1]
	Reserved
	Reserved
(5)	[F40,F41,F50-OH1.1]
	Reserved
(6)	[F40,F41,F50-OH1.1]
	Reserved
<b>9.32.3.5. Principal Ventilation System Exhaust Fan</b>	
(1)	[F40,F41,F50-OH1.1] [F52-OH1.2] [F52,F62,F63-OH1.3]
	[F52,F62,F63,F80-OP2.3]
(2)	[F81-OH1.1,OH1.2,OH1.3]
	[F81-OP2.3]
	Reserved

(3)	(a) [F40,F41,F50-OH1.1] [F52-OH1.2] [F52,F62,F63-OH1.3]
	(a) [F52,F62,F63,F80-OP2.3]
	(b) [F81-OH1.1,OH1.2,OH1.3]
	(b) [F81-OP2.3]
(4)	[F81-OH1.1,OH1.2,OH1.3]
	[F81-OP2.3]
	Reserved
(5)	[F56-OH3.1]
	Reserved
	Reserved
<b>9.32.3.6. Kitchen and Bathroom Exhaust Fans</b>	
(1)	[F52,F62,F63-OH1.3]
	[F52,F62,F63,F80-OP2.3]
(2)	[F81-OH1.1,OH1.2,OH1.3]
	[F81-OP2.3]
<b>9.32.3.7. Heated Crawl Space Ventilation</b>	
(1)	[F40,F41,F52,F62,F63,F80-OP2.3]
(2)	[F40,F41,F52,F62,F63,F80-OP2.3]
(3)	[F40,F41,F52,F62,F63,F80-OP2.3]
(4)	[F40,F41,F52,F62,F63,F80-OP2.3]
(5)	[F40,F41,F52,F62,F63,F80-OP2.3]
<b>9.32.3.8. Air Ducts</b>	
(1)	[F40,F41,F50-OH1.1]
	[F52,F62,F63-OH1.3]
	[F52,F62,F63,F80-OP2.3]
(2)	[F62-OH1.3]
	[F62-OP2.3]
(3)	[F40,F41,F50-OH1.1] [F52,F62,F63-OH1.3]
	[F52,F62,F63,F80-OP2.3]
	Table 9.32.3.8.(3), Note (1) [F81-OH1.1,OH1.3]
	Table 9.32.3.8.(3), Note (1) [F81-OP2.3]
(4)	[F51,F63-OH1.3]
	[F63,F80-OP2.3]
	Reserved
(5)	[F51,F63-OH1.3]
	[F63,F80-OP2.3]
(6)	(a) [F01,F02-OS1.1,OS1.2]

	(a) [F80,F82-OP2.3]
	(b) [F40,F80-OP2.3]
(7)	[F50,F81-OH1.1]
	[F81-OH1.3]
	[F81-OP2.3]
(8)	[F40,F81-OH1.1]
<b>9.32.3.9. Outdoor Inlets and Outlets</b>	
(1)	[F42-OH2.5]
	[F61,F81-OP2.3]
<b>9.32.3.10. Interior Distribution</b>	
(1)	[F40,F50-OH1.1] [F52-OH1.2]
	Reserved
<b>9.32.4.1. Protection Requirements</b>	
(1)	(a) [F40,F81-OH1.1]
	(b) [F40,F50,F53-OH1.1]
	(b) [F43-OS3.4]
(2)	[F40,F50,F53-OH1.1]
(3)	[F40,F50,F53,F81-OH1.1]
(4)	[F51-OH1.2]
<b>9.32.4.2. Carbon Monoxide Alarms</b>	
(2)	[F11,F81-OS3.4]
(3)	[F11,F81-OS3.4]
(4)	[F11-OS3.4]
(5)	[F11-OS3.4]
(6)	[F11-OS3.4]
<b>9.33.1.1. Application</b>	
(3)	[F40-OH1.1]
	[F40-OS3.4]
<b>9.33.2.1. Required Heating Systems</b>	
(1)	[F51,F52-OH1.2] [F63-OH1.1]
	[F63-OS2.3]
<b>9.33.3.1. Indoor Design Temperatures</b>	
(1)	[F51-OH1.2]

<b>9.33.4.1. Design of Heating and Air-conditioning Systems</b>	
(1)	[F41,F63-OH1.1] [F51,F52-OH1.2]
	[F63-OS2.3] Applies only to heating systems.
	[F44-OS3.4] Applies only to heating systems.
<b>9.33.4.2. Installation of Hydronic Heating Systems</b>	
(1)	[F01-OS1.1]
	[F01-OP1.1]
	[F63-OH1.1] [F51,F52-OH1.2]
	[F63-OS2.3]
	[F44-OS3.4] Applies to heating equipment.
<b>9.33.4.3. Heating System Control</b>	
(1)	[F51,F52-OH1.2] [F63-OH1.1]
<b>9.33.4.4. Access</b>	
(1)	[F82-OH1.1,OH1.2]
	[F82-OS2.3] Applies only to heating systems.
	[F82-OS1.1]
	[F82-OP1.1]
<b>9.33.4.5. Protection from Freezing</b>	
(1)	[F81-OH1.1,OH1.2]
	[F81-OS2.3] Applies only to heating systems.
<b>9.33.4.6. Expansion, Contraction and System Pressure</b>	
(1)	[F20-OH1.1,OH1.2]
	[F20-OS3.2]
	[F20-OS2.3] Applies only to heating systems.
<b>9.33.4.7. Structural Movement</b>	
(1)	[F23-OS3.4]
	[F23-OH1.1,OH1.2]
	[F23-OS1.1]
	[F23-OP1.1]
(2)	[F20-OS3.3,OS3.4]
	[F20-OS1.1]
<b>9.33.4.8. Asbestos</b>	
(1)	[F43-OH1.1]
<b>9.33.4.9. Contaminant Transfer</b>	
(1)	[F44-OH1.1]
	[F44-OS3.4]
<b>9.33.5.1. Capacity of Heating Appliances</b>	

(1)	[F63-OH1.1] [F51-OH1.2]
	[F63-OS2.3]
<b>9.33.5.2. Installation Standards</b>	
(1)	[F01-OP1.1] Applies to heating equipment.
	[F41,F63,F50-OH1.1] [F51,F52-OH1.2]
	[F63-OS2.3] Applies to heating equipment.
	[F44-OS3.4] Applies to heating equipment.
	[F01-OS1.1] Applies to heating equipment.
<b>9.33.5.3. Design, Construction and Installation Standard for Solid-Fuel-Burning Appliances</b>	
(1)	[F41,F43-OH1.1] [F51-OH1.2]
	[F51-OS2.3]
	[F43-OS3.4]
	[F01-OS1.1]
	[F01-OP1.1]
<b>9.33.6.2. Materials in Air Duct Systems</b>	
(1)	[F01-OS1.1]
	[F01-OP1.1]
(2)	(a),(b),(c),(d) [F01-OS1.1]
	(a),(b),(c),(d) [F01-OP1.1]
(3)	[F01-OS1.1]
	[F01-OP1.1]
(4)	(a),(b),(c),(d) [F01-OS1.1]
	(a),(b),(c),(d) [F01-OP1.1]
(7)	(a),(b) [F41,F63-OH1.1] [F50,F51,F52-OH1.2]
	(a),(b) [F63-OS2.3]
<b>9.33.6.3. Tape</b>	
(1)	[F01-OS1.1]
	[F01-OP1.1]
<b>9.33.6.4. Coverings, Linings, Adhesives and Insulation</b>	
(1)	[F01-OS1.1]
	[F01-OP1.1]
(2)	(a),(b) [F01-OS1.1]
	(a),(b) [F01-OP1.1]
(3)	(a),(b) [F01-OS1.1]
	(a),(b) [F01-OP1.1]
(4)	[F01-OS1.1]
	[F01-OP1.1]

(5)	[F01-OS1.1]
	[F01-OP1.1]
(6)	[F01-OS1.1]
	(c) [F01,F02,F05-OS1.5]
	[F01-OP1.1]
(7)	[F01-OS1.1]
	[F01-OP1.1]
(8)	(a),(b) [F01,F03-OS1.1]
	(a),(b) [F01,F03-OP1.1]
(9)	[F63-OH1.1] Applies to ventilation ducts and their fittings. [F51,F52-OH1.2] Applies to air duct distribution systems serving heating systems.
	[F03-OS1.1] Applies to air duct distribution systems.
	[F03-OP1.1] Applies to air duct distribution systems.
	[F63-OS2.3] Applies to air duct distribution systems.
<b>9.33.6.5. Galvanized Steel or Aluminum Supply Ducts</b>	
(1)	[F20-OH1.1,OH1.2]
	[F01-OS1.1]
	[F01-OP1.1]
(2)	[F20,F63-OH1.1] [F20,F51,F52-OH1.2]
	[F20,F63-OS2.3]
<b>9.33.6.6. Construction of Ducts and Plenums</b>	
(1)	[F03-OS1.1]
	[F03-OP1.1]
(2)	[F01-OS1.1]
	[F20-OS3.1]
	[F63-OH1.1] [F51,F52-OH1.2]
	[F20,F63-OS2.3]
(3)	[F43,F63-OH1.1] [F51,F52-OH1.2]
	[F01-OS1.1]
	[F63-OS2.3]
	[F01-OP1.1]
(4)	[F43,F63-OH1.1] [F51,F52-OH1.2]
	[F63-OS2.3]
	[F01-OS1.1]
	[F01-OP1.1]
(5)	[F63-OH1.1] [F51,F52-OH1.2]
	[F63-OS2.3]



	[F01-OS1.1]
	[F01-OP1.1]
<b>9.33.6.7. Installation of Ducts and Plenums</b>	
(1)	[F40-OH1.1]
	[F40-OS3.4]
(2)	[F63-OH1.1] [F51,F52-OH1.2]
	[F63-OS2.3]
	[F01-OS1.1]
	[F01-OP1.1]
(3)	[F63-OH1.1] [F51,F52-OH1.2]
	[F63-OS2.3]
	[F20-OS3.1]
(4)	[F51,F52-OH1.2] [F63,F50-OH1.1]
	[F63,F80-OS2.3]
(5)	[F01-OS1.1]
	[F01-OP1.1]
(6)	[F80-OH1.1,OH1.2]
	[F80-OS2.3]
(7)	(a),(b) [F40,F62-OH1.1,OH1.2]
	(a),(b) [F40,F62-OS2.3]
	(b) [F44-OS3.4]
<b>9.33.6.8. Clearances of Ducts and Plenums</b>	
(2)	(a),(b) [F01-OS1.1]
	(a),(b) [F01-OP1.1]
(3)	(a),(b) [F01-OS1.1]
	(a),(b) [F01-OP1.1]
(4)	(a),(b),(c) [F01-OS1.1]
	(a),(b),(c) [F01-OP1.1]
(5)	[F01-OS1.1]
	[F01-OP1.1]
<b>9.33.6.9. Adjustable Dampers and Balance Stops</b>	
(1)	[F40,F63-OH1.1] [F51,F52-OH1.2]
	[F63-OS2.3] Applies to branch <i>supply ducts</i> that are not fitted with diffusers with adjustable balance stops.
<b>9.33.6.10. Warm-Air Supply Outlets and Return Inlets — General</b>	
(1)	[F81-OS1.1]
	[F81-OH1.1,OH1.2]
	[F81-OS2.3]

(2)	(a),(b) [F01,F02-OS1.1]
	(a),(b) [F01,F02-OP1.1]
<b>9.33.6.11. Warm-Air Supply Outlets</b>	
(1)	[F40,F63-OH1.1] [F51,F52-OH1.2]
	[F63-OS2.3]
(2)	[F63-OH1.1] [F51-OH1.2]
	[F63-OS2.3]
(3)	[F40,F63-OH1.1] [F51-OH1.2]
(4)	[F40,F63-OH1.1] [F51-OH1.2]
	[F63-OS2.3]
(5)	[F40,F63-OH1.1] [F51-OH1.2]
	[F63-OS2.3]
(6)	[F40,F63-OH1.1] [F51-OH1.2]
	[F63-OS2.3]
(8)	[F31-OS3.2]
(9)	[F40,F63-OH1.1] [F51-OH1.2]
	[F63-OS2.3] Applies to warm-air supply outlets located in finished areas.
<b>9.33.6.12. Return-Air Inlets</b>	
(1)	[F44,F40-OH1.1]
	[F44,F40-OS3.4]
(2)	[F63-OH1.1] [F51-OH1.2]
(3)	[F63-OH1.1] [F51-OH1.2]
	[F63-OS2.3]
<b>9.33.6.13. Return-Air System</b>	
(1)	[F63-OH1.1] [F51-OH1.2]
	[F63-OS2.3]
(2)	[F01-OS1.1]
	[F01-OP1.1]
(3)	[F01-OS1.1]
	[F01-OP1.1]
(4)	(a),(b),(c) [F01-OS1.1]
	(a),(b),(c) [F01-OP1.1]
(5)	[F51,F52-OH1.1,OH1.2]
	[F51,F52-OS2.3]
(6)	[F63-OH1.1] [F51-OH1.2]
	[F63-OS2.3]
(7)	(a),(b) [F44-OH1.1]

	(a),(b) [F44-OS3.4]
<b>9.33.6.14. Filters and Odour Removal Equipment</b>	
(1)	[F01-OS1.1]
	[F01-OP1.1]
(2)	[F32-OS3.3]
	[F41-OH1.1]
(3)	(a),(b) [F81-OH1.1]
<b>9.33.7.1. Recessed Radiators and Convector</b>	
(1)	[F01-OS1.1]
	[F01-OP1.1]
<b>9.33.7.2. Surface Temperature</b>	
(1)	[F31-OS3.2]
<b>9.33.8.1. Piping Materials and Installation</b>	
(1)	[F20-OS3.2]
	[F20-OH1.1,OH1.2]
(2)	[F21,F40-OH1.1] [F21,F51-OH1.2]
(3)	[F20-OS2.2]
<b>9.33.8.2. Insulation and Coverings</b>	
(1)	[F80-OH1.2]
	[F80-OS3.2]
(2)	(a),(b) [F01-OS1.1]
	(a),(b) [F01-OP1.1]
(3)	(a),(b) [F01,F02-OS1.1,OS1.2]
	(a),(b) [F01,F02-OP1.1,OP1.2]
(4)	[F01,F02-OS1.1,OS1.2]
	[F01,F02-OP1.1]
(5)	[F31-OS3.2]
<b>9.33.8.3. Clearances</b>	
(1)	[F01-OS1.1]
	[F01-OP1.1]
<b>9.33.8.4. Protection</b>	
(1)	[F01-OS1.1]
	[F01-OP1.1]
(2)	[F01-OS1.1]
	[F01-OP1.1]
<b>9.33.9.1. Cooling Units</b>	
(1)	(a),(b),(c) [F43-OH1.1] [F51-OH1.2]

<b>9.33.10.2. Factory-Built Chimneys</b>	
(1)	[F01-OS1.1]
	[F44-OS3.4]
	[F44,F41-OH1.1]
	[F01-OP1.1]
<b>9.34.1.1. Standard for Electrical Installations</b>	
(1)	[F32-OS3.3]
	[F01-OS1.1]
	[F01-OP1.1]
<b>9.34.1.3. Location of Equipment in Public Areas</b>	
(1)	[F10-OS3.1] [F32-OS3.3]
<b>9.34.1.4. Recessed Lighting Fixtures</b>	
(1)	[F01-OS1.1]
<b>9.34.1.5. Wiring and Cables</b>	
(1)	[F02-OS1.2]
	[F02-OP1.2]
<b>9.34.2.1. Lighting of Entrances</b>	
(1)	[F30-OS3.1]
	[F34-OS4.2]
<b>9.34.2.2. Outlets in Dwelling Units</b>	
(1)	[F30-OS3.1]
(2)	[F30-OS3.1]
<b>9.34.2.3. Stairways</b>	
(1)	[F30-OS3.1]
(2)	[F30-OS3.1]
<b>9.34.2.4. Basements</b>	
(1)	[F30-OS3.1]
(2)	[F30-OS3.1]
<b>9.34.2.5. Storage Rooms</b>	
(1)	[F30-OS3.1]
<b>9.34.2.6. Garages and Carports</b>	
(1)	[F30-OS3.1]
(2)	[F30-OS3.1]
(3)	[F30-OS3.1]
<b>9.34.2.7. Public and Service Areas</b>	
(1)	[F30-OS3.1]
(2)	[F30-OS3.1]

(3)	[F30-OS3.1]
<b>9.35.2.2. Garage Floor</b>	
(1)	[F40-OS1.1]
<b>9.35.3.2. Protection from Damage due to Soil Movement</b>	
(1)	[F21-OS2.3]
	[F21-OH1.1,OH1.2,OH1.3]
	[F21-OP2.3,OP2.4]
	[F21-OH4] Applies to floors and elements that support floors.
	[F21-OS3.1] Applies to floors and elements that support floors.
(2)	[F21-OS2.3]
	[F21-OH1.1,OH1.2,OH1.3]
	[F21-OP2.3,OP2.4]
	[F21-OH4] Applies to floors and elements that support floors.
	[F21-OS3.1] Applies to floors and elements that support floors.
<b>9.35.3.4. Column Piers</b>	
(1)	[F80-OS2.3]
	[F80-OP2.3]
(2)	[F20-OS2.1,OS2.2]
	[F20-OP2.1,OP2.2]
<b>9.35.4.2. Columns</b>	
(1)	[F20-OS2.1]
	[F20-OP2.1]
<b>9.35.4.3. Anchorage</b>	
(1)	[F22-OS2.4,OS2.5]
	[F22-OP2.4,OP2.5]

Notes to Table 9.38.1.1.:

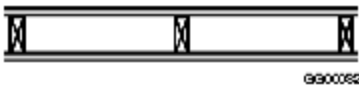

(1) See Parts 2 and 3 of Division A.

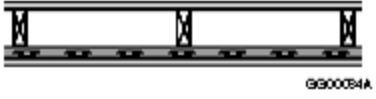

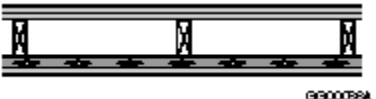
# Fire and Sound Resistance Tables

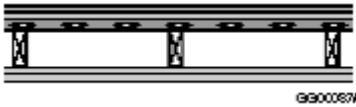
Table 9.10.3.1.-A

## Fire and Sound Resistance of Walls(1)


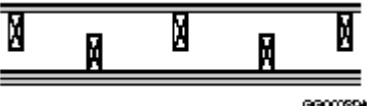

Forming Part of Article 5.8.1.3., Sentence 9.10.3.1.(1), Articles 9.11.1.3. and 9.11.1.4., and Sentence 9.29.5.9.(5)

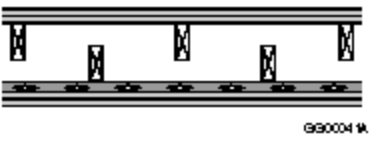

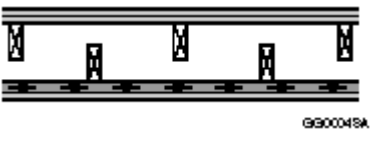
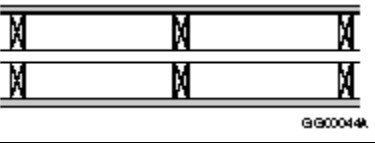
Type of Wall	Wall Number	Description	Fire-Resistance Rating <sup>(2)(3)(4)</sup>		Typical Sound Transmission Class <sup>(2)(4)(5)</sup>
			Loadbearing	Non-Loadbearing	
• Wood Studs	<b>W1</b>	<ul style="list-style-type: none"> <li>• 38 mm × 89 mm studs spaced 400 mm or 600 mm o.c.</li> <li>• with or without absorptive material</li> <li>• 1 layer of gypsum board on each side</li> </ul>			
• Single Row	W1a	<ul style="list-style-type: none"> <li>• W1 with</li> <li>• 89 mm thick absorptive material<sup>(6)</sup></li> <li>• 15.9 mm Type X gypsum board<sup>(7)</sup></li> </ul>	1 h	1 h	36
• Loadbearing or Non-Loadbearing	W1b	<ul style="list-style-type: none"> <li>• W1 with</li> <li>• 89 mm thick absorptive material<sup>(6)</sup></li> <li>• 12.7 mm Type X gypsum board<sup>(7)</sup></li> </ul>	45 min [1 h <sup>(8)</sup> ]	45 min [1 h <sup>(8)</sup> ]	34
	W1c	<ul style="list-style-type: none"> <li>• W1 with</li> <li>• 89 mm thick absorptive material<sup>(6)</sup></li> <li>• 12.7 mm regular gypsum board<sup>(7)(9)</sup></li> </ul>	30 min	30 min [45 min <sup>(8)</sup> ]	32
	W1d	<ul style="list-style-type: none"> <li>• W1 with</li> <li>• no absorptive material</li> <li>• 15.9 mm Type X gypsum board<sup>(7)</sup></li> </ul>	1 h	1 h	32
	W1e	<ul style="list-style-type: none"> <li>• W1 with</li> <li>• no absorptive material</li> <li>• 12.7 mm Type X gypsum board<sup>(7)</sup></li> </ul>	45 min	45 min	32
	<b>W2</b>	<ul style="list-style-type: none"> <li>• 38 mm × 89 mm studs spaced 400 mm or 600 mm o.c.</li> <li>• with or without absorptive material</li> <li>• 2 layers of gypsum board on each side</li> </ul>			
	W2a	<ul style="list-style-type: none"> <li>• W2 with</li> <li>• 89 mm thick absorptive material<sup>(6)</sup></li> <li>• 15.9 mm Type X gypsum board<sup>(7)</sup></li> </ul>	1.5 h	2 h	38
	W2b	<ul style="list-style-type: none"> <li>• W2 with</li> <li>• 89 mm thick absorptive material<sup>(6)</sup></li> <li>• 12.7 mm Type X gypsum board<sup>(7)</sup></li> </ul>	1 h	1.5 h	38
	W2c	<ul style="list-style-type: none"> <li>• W2 with</li> <li>• 89 mm thick absorptive material<sup>(6)</sup></li> <li>• 12.7 mm regular gypsum board<sup>(7)</sup></li> </ul>	45 min	1 h	36
	W2d	<ul style="list-style-type: none"> <li>• W2 with</li> <li>• no absorptive material</li> <li>• 15.9 mm Type X gypsum board<sup>(7)</sup></li> </ul>	1.5 h	2 h	36
	W2e	<ul style="list-style-type: none"> <li>• W2 with</li> <li>• no absorptive material</li> <li>• 12.7 mm Type X gypsum board<sup>(7)</sup></li> </ul>	1 h	1.5 h	35

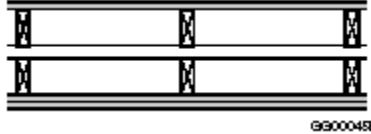
	W2f	W2 with <ul style="list-style-type: none"> <li>• no absorptive material</li> <li>• 12.7 mm regular gypsum board<sup>(7)</sup></li> </ul>	45 min	1 h	34
	<b>W3</b>	<ul style="list-style-type: none"> <li>• 38 mm × 89 mm studs spaced 400 mm or 600 mm o.c.</li> <li>• 89 mm thick absorptive material<sup>(6)</sup></li> <li>• resilient metal channels on one side spaced 400 mm or 600 mm o.c.</li> <li>• 1 layer of gypsum board on each side</li> </ul>			
	W3a	W3 with <ul style="list-style-type: none"> <li>• studs spaced 400 mm o.c.</li> <li>• 15.9 mm Type X gypsum board<sup>(7)</sup></li> </ul>	45 min	1 h	45
	W3b	W3 with <ul style="list-style-type: none"> <li>• studs spaced 600 mm o.c.</li> <li>• 15.9 mm Type X gypsum board<sup>(7)</sup></li> </ul>	45 min	1 h	48
	W3c	W3 with <ul style="list-style-type: none"> <li>• studs spaced 400 mm or 600 mm o.c.</li> <li>• 12.7 mm Type X gypsum board<sup>(7)</sup></li> </ul>	45 min	45 min	43
	<b>W4</b>	<ul style="list-style-type: none"> <li>• 38 mm × 89 mm studs spaced 400 mm or 600 mm o.c.</li> <li>• 89 mm thick absorptive material<sup>(6)</sup></li> <li>• resilient metal channels on one side spaced 400 mm or 600 mm o.c.</li> <li>• 2 layers of gypsum board on resilient metal channel side</li> <li>• 1 layer of gypsum board on other side</li> </ul>			
	W4a	W4 with <ul style="list-style-type: none"> <li>• studs spaced 400 mm o.c.</li> <li>• 15.9 mm Type X gypsum board<sup>(7)</sup></li> </ul>	1 h	1 h [1.5 h <sup>(6)</sup> ]	51
	W4b	W4 with <ul style="list-style-type: none"> <li>• studs spaced 600 mm o.c.</li> <li>• 15.9 mm Type X gypsum board<sup>(7)</sup></li> </ul>	1 h	1 h [1.5 h <sup>(6)</sup> ]	54
	W4c	W4 with <ul style="list-style-type: none"> <li>• studs spaced 400 mm o.c.</li> <li>• 12.7 mm Type X gypsum board<sup>(7)</sup></li> </ul>	45 min [1 h <sup>(6)</sup> ]	1 h	49
	W4d	W4 with <ul style="list-style-type: none"> <li>• studs spaced 600 mm o.c.</li> <li>• 12.7 mm Type X gypsum board<sup>(7)</sup></li> </ul>	45 min [1 h <sup>(6)</sup> ]	1 h	53
	<b>W5</b>	<ul style="list-style-type: none"> <li>• 38 mm × 89 mm studs spaced 400 mm or 600 mm o.c.</li> <li>• 89 mm thick absorptive material<sup>(6)</sup></li> <li>• resilient metal channels on one side spaced 400 mm or 600 mm o.c.</li> <li>• 1 layer of gypsum board on resilient metal channel side</li> <li>• 2 layers of gypsum board on other side</li> </ul>			
	W5a	W5 with <ul style="list-style-type: none"> <li>• studs spaced 400 mm o.c.</li> <li>• 15.9 mm Type X gypsum board<sup>(7)</sup></li> </ul>	45 min	1 h	51
	W5b	W5 with <ul style="list-style-type: none"> <li>• studs spaced 600 mm o.c.</li> <li>• 15.9 mm Type X gypsum board<sup>(7)</sup></li> </ul>	45 min	1 h	54
	W5c	W5 with <ul style="list-style-type: none"> <li>• studs spaced 400 mm o.c.</li> <li>• 12.7 mm Type X gypsum board<sup>(7)</sup></li> </ul>	45 min	1 h	49


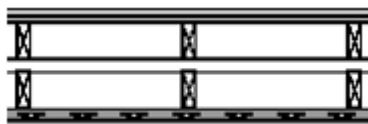
	W5d	W5 with • studs spaced 600 mm o.c. • 12.7 mm Type X gypsum board <sup>(7)</sup>	45 min	1 h	53
	<b>W6</b>	• 38 mm × 89 mm studs spaced 400 mm or 600 mm o.c. • with or without absorptive material • resilient metal channels on one side • 2 layers of gypsum board on each side			
	W6a	W6 with • studs spaced 400 mm or 600 mm o.c. • 89 mm thick absorptive material <sup>(6)</sup> • resilient metal channels spaced 400 mm o.c. • 15.9 mm Type X gypsum board <sup>(7)</sup>	1.5 h	2 h	55
	W6b	W6 with • studs spaced 400 mm or 600 mm o.c. with blocking at mid-height <sup>(10)</sup> • 89 mm thick rock or slag fibre insulation <sup>(11)</sup> • resilient metal channels spaced 400 mm or 600 mm o.c. • 15.9 mm Type X gypsum board <sup>(7)</sup>	2 h	2 h	–
	W6c	W6 with • studs spaced 400 mm o.c. with blocking at mid-height <sup>(10)</sup> • 89 mm thick dry-blown cellulose fibre insulation <sup>(12)</sup> • resilient metal channels spaced 400 mm o.c. • 15.9 mm Type X gypsum board <sup>(7)</sup>	2 h	2 h	–
	W6d	W6 with • studs spaced 400 mm or 600 mm o.c. • 89 mm thick absorptive material <sup>(6)</sup> • resilient metal channels spaced 600 mm o.c. • 15.9 mm Type X gypsum board <sup>(7)</sup>	1.5 h	2 h	58
	W6e	W6 with • studs spaced 400 mm o.c. • 89 mm thick absorptive material <sup>(6)</sup> • resilient metal channels spaced 400 mm o.c. • 12.7 mm Type X gypsum board <sup>(7)</sup>	1 h	1.5 h	53
	W6f	W6 with • studs spaced 400 mm o.c. • 89 mm thick absorptive material <sup>(6)</sup> • resilient metal channels spaced 600 mm o.c. • 12.7 mm Type X gypsum board <sup>(7)</sup>	1 h	1.5 h	55
	W6g	W6 with • studs spaced 600 mm o.c. • 89 mm thick absorptive material <sup>(6)</sup> • resilient metal channels spaced 400 mm o.c. • 12.7 mm Type X gypsum board <sup>(7)</sup>	1 h	1.5 h	55
	W6h	W6 with • studs spaced 600 mm o.c. • 89 mm thick absorptive material <sup>(6)</sup> • resilient metal channels spaced 600 mm o.c. • 12.7 mm Type X gypsum board <sup>(7)</sup>	1 h	1.5 h	58
	W6i	W6 with • studs spaced 400 mm or 600 mm o.c. • no absorptive material	1.5 h	2 h	47





		<ul style="list-style-type: none"> <li>resilient metal channels spaced 400 mm or 600 mm o.c.</li> <li>15.9 mm Type X gypsum board<sup>(7)</sup></li> </ul>			
	W6j	<ul style="list-style-type: none"> <li>W6 with</li> <li>studs spaced 400 mm or 600 mm o.c.</li> <li>no absorptive material</li> <li>resilient metal channels spaced 400 mm or 600 mm o.c.</li> <li>12.7 mm Type X gypsum board<sup>(7)</sup></li> </ul>	1 h	1.5 h	46
<ul style="list-style-type: none"> <li>Wood Studs</li> <li>Two Rows Staggered on 38 mm × 140 mm Plate</li> </ul>	<b>W7</b>	<ul style="list-style-type: none"> <li>two rows 38 mm × 89 mm studs each spaced 400 mm or 600 mm o.c. staggered on common 38 mm × 140 mm plate</li> <li>89 mm thick absorptive material on one side or 65 mm thick on each side<sup>(6)</sup></li> <li>1 layer of gypsum board on each side</li> </ul>			
<ul style="list-style-type: none"> <li>Loadbearing or Non-Loadbearing</li> </ul>	W7a	<ul style="list-style-type: none"> <li>W7 with</li> <li>15.9 mm Type X gypsum board<sup>(7)</sup></li> </ul>	1 h	1 h	47
	W7b	<ul style="list-style-type: none"> <li>W7 with</li> <li>12.7 mm Type X gypsum board<sup>(7)</sup></li> </ul>	45 min [1 h <sup>(8)</sup> ]	45 min [1 h <sup>(8)</sup> ]	45
	W7c	<ul style="list-style-type: none"> <li>W7 with</li> <li>12.7 mm regular gypsum board<sup>(7)(9)</sup></li> </ul>	30 min	30 min [45 min <sup>(8)</sup> ]	42
	<b>W8</b>	<ul style="list-style-type: none"> <li>Two rows 38 mm × 89 mm studs each spaced 400 mm or 600 mm o.c. staggered on common 38 mm × 140 mm plate</li> <li>89 mm thick absorptive material on one side or 65 mm thick on each side<sup>(6)</sup></li> <li>2 layers of gypsum board on one side</li> <li>1 layer of gypsum board on other side</li> </ul>			
	W8a	<ul style="list-style-type: none"> <li>W8 with</li> <li>15.9 mm Type X gypsum board<sup>(7)</sup></li> </ul>	1 h	1.5 h	52
	W8b	<ul style="list-style-type: none"> <li>W8 with</li> <li>12.7 mm Type X gypsum board<sup>(7)</sup></li> </ul>	45 min	1 h	50
	<b>W9</b>	<ul style="list-style-type: none"> <li>two rows 38 mm × 89 mm studs each spaced 400 mm or 600 mm o.c. staggered on common 38 mm × 140 mm plate</li> <li>with or without absorptive material</li> <li>2 layers of gypsum board on each side</li> </ul>			
	W9a	<ul style="list-style-type: none"> <li>W9 with</li> <li>89 mm thick absorptive material on one side or 65 mm thick on each side<sup>(6)</sup></li> <li>15.9 mm Type X gypsum board<sup>(7)</sup></li> </ul>	1.5 h	2 h	56
	W9b	<ul style="list-style-type: none"> <li>W9 with</li> <li>89 mm thick absorptive material on one side or 65 mm thick on each side<sup>(6)</sup></li> <li>12.7 mm Type X gypsum board<sup>(7)</sup></li> </ul>	1 h	1.5 h	55
	W9c	<ul style="list-style-type: none"> <li>W9 with</li> <li>89 mm thick absorptive material on one side or 65 mm thick on each side<sup>(6)</sup></li> <li>12.7 mm regular gypsum board<sup>(7)</sup></li> </ul>	45 min	1 h	53
	W9d	<ul style="list-style-type: none"> <li>W9 with</li> <li>no absorptive material</li> <li>15.9 mm Type X gypsum board<sup>(7)</sup></li> </ul>	1.5 h	2 h	48


	<b>W10</b>	<ul style="list-style-type: none"> <li>two rows 38 mm × 89 mm studs each spaced 400 mm or 600 mm o.c. staggered on common 38 mm × 140 mm plate</li> <li>with or without absorptive material</li> <li>resilient metal channels on one side spaced 400 mm or 600 mm o.c.</li> <li>2 layers of gypsum board on each side</li> </ul>			
	W10a	<ul style="list-style-type: none"> <li>W10 with</li> <li>89 mm thick absorptive material on one side or 65 mm thick on each side<sup>(6)</sup></li> <li>15.9 mm Type X gypsum board<sup>(7)</sup></li> </ul>	1.5 h	2 h	62
	W10b	<ul style="list-style-type: none"> <li>W10 with</li> <li>89 mm thick absorptive material on one side or 65 mm thick on each side<sup>(6)</sup></li> <li>12.7 mm Type X gypsum board<sup>(7)</sup></li> </ul>	1 h	1.5 h	60
	W10c	<ul style="list-style-type: none"> <li>W10 with</li> <li>no absorptive material</li> <li>15.9 mm Type X gypsum board<sup>(7)</sup></li> </ul>	1.5 h	2 h	50
	W10d	<ul style="list-style-type: none"> <li>W10 with</li> <li>no absorptive material</li> <li>12.7 mm Type X gypsum board<sup>(7)</sup></li> </ul>	1 h	1.5 h	48
	<b>W11</b>	<ul style="list-style-type: none"> <li>two rows 38 mm × 89 mm studs each spaced 400 mm or 600 mm o.c. staggered on common 38 mm × 140 mm plate</li> <li>89 mm thick absorptive material on one side or 65 mm thick on each side<sup>(6)</sup></li> <li>resilient metal channels on one side spaced 400 mm or 600 mm o.c.</li> <li>2 layers of gypsum board on resilient channel side</li> <li>1 layer of gypsum board on other side</li> </ul>			
	W11a	<ul style="list-style-type: none"> <li>W11 with</li> <li>15.9 mm Type X gypsum board<sup>(7)</sup></li> </ul>	1 h	1 h	56
	W11b	<ul style="list-style-type: none"> <li>W11 with</li> <li>12.7 mm Type X gypsum board<sup>(7)</sup></li> </ul>	45 min [1 h <sup>(6)</sup> ]	1 h	54
	<b>W12</b>	<ul style="list-style-type: none"> <li>two rows 38 mm × 89 mm studs each spaced 400 mm or 600 mm o.c. staggered on common 38 mm × 140 mm plate</li> <li>89 mm thick absorptive material on one side or 65 mm thick on each side<sup>(6)</sup></li> <li>resilient metal channels on one side spaced 400 mm or 600 mm o.c.</li> <li>1 layer of gypsum board on resilient metal channel side</li> <li>2 layers of gypsum board on other side</li> </ul>			
	W12a	<ul style="list-style-type: none"> <li>W12 with</li> <li>15.9 mm Type X gypsum board<sup>(7)</sup></li> </ul>	45 min	1 h	56
	W12b	<ul style="list-style-type: none"> <li>W12 with</li> <li>12.7 mm Type X gypsum board<sup>(7)</sup></li> </ul>	45 min	1 h	54
<ul style="list-style-type: none"> <li>Wood Studs</li> <li>Two Rows on Separate Plates</li> </ul>	<b>W13</b>	<ul style="list-style-type: none"> <li>two rows 38 mm × 89 mm studs, each spaced 400 mm or 600 mm o.c. on separate 38 mm × 89 mm plates set 25 mm apart</li> <li>with or without absorptive material</li> <li>1 layer of gypsum board on each side</li> </ul>			

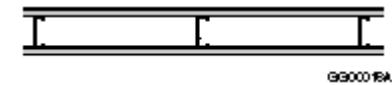
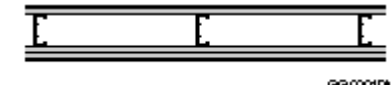
• Loadbearing or Non- Loadbearing	W13a	W13 with • 89 mm thick absorptive material on each side <sup>(6)(13)</sup> • 15.9 mm Type X gypsum board <sup>(7)</sup>	1 h	1 h	57
	W13b	W13 with • 89 mm thick absorptive material on each side <sup>(6)(13)</sup> • 12.7 mm Type X gypsum board <sup>(7)</sup>	45 min [1 h <sup>(8)</sup> ]	45 min [1 h <sup>(8)</sup> ]	57
	W13c	W13 with • 89 mm thick absorptive material on one side only <sup>(6)(13)</sup> • 15.9 mm Type X gypsum board <sup>(7)</sup>	1 h	1 h	54
	W13d	W13 with • 89 mm thick absorptive material on one side only <sup>(6)(13)</sup> • 12.7 mm Type X gypsum board <sup>(7)</sup>	45 min	45 min	53
	W13e	W13 with • no absorptive material • 15.9 mm Type X gypsum board <sup>(7)</sup>	1 h	1 h	45
	W13f	W13 with • no absorptive material • 12.7 mm Type X gypsum board <sup>(7)</sup>	45 min	45 min	45
	<b>W14</b>	<ul style="list-style-type: none"> <li>• two rows 38 mm × 89 mm studs, each spaced 400 mm or 600 mm o.c. on separate 38 mm × 89 mm plates set 25 mm apart</li> <li>• with or without absorptive material</li> <li>• 2 layers of gypsum board on one side</li> <li>• 1 layer of gypsum board on other side</li> </ul>			
	W14a	W14 with • 89 mm thick absorptive material on each side <sup>(6)(13)</sup> • 15.9 mm Type X gypsum board <sup>(7)</sup>	1 h	1 h [1.5 h <sup>(8)</sup> ]	61
	W14b	W14 with • 89 mm thick absorptive material on each side <sup>(6)(13)</sup> • 12.7 mm Type X gypsum board <sup>(7)</sup>	45 min	1 h	61
	W14c	W14 with • 89 mm thick absorptive material on one side only <sup>(6)(13)</sup> • 15.9 mm Type X gypsum board <sup>(7)</sup>	1 h	1 h	57
	W14d	W14 with • 89 mm thick absorptive material on one side only <sup>(6)(13)</sup> • 12.7 mm Type X gypsum board <sup>(7)</sup>	45 min	1 h	57
	W14e	W14 with • no absorptive material • 15.9 mm Type X gypsum board <sup>(7)</sup>	1 h	1 h	51
	W14f	W14 with • no absorptive material • 12.7 mm Type X gypsum board <sup>(7)</sup>	45 min	1 h	51

	<b>W15</b>	<ul style="list-style-type: none"> <li>• two rows 38 mm × 89 mm studs, each spaced 400 mm or 600 mm o.c. on separate 38 mm × 89 mm plates set 25 mm apart</li> <li>• with or without absorptive material</li> <li>• 2 layers of gypsum board on each side</li> </ul>	 GG00045B		
	W15a	<ul style="list-style-type: none"> <li>• W15 with</li> <li>• 89 mm thick absorptive material on each side<sup>(6)(13)</sup></li> <li>• 15.9 mm Type X gypsum board<sup>(7)</sup></li> </ul>	1.5 h	2 h	66
	W15b	<ul style="list-style-type: none"> <li>• W15 with</li> <li>• 89 mm thick absorptive material on each side<sup>(6)(13)</sup></li> <li>• 12.7 mm Type X gypsum board<sup>(7)</sup></li> </ul>	1 h	1.5 h	65
	W15c	<ul style="list-style-type: none"> <li>• W15 with</li> <li>• 89 mm thick absorptive material on each side<sup>(6)(13)</sup></li> <li>• 12.7 mm regular gypsum board<sup>(7)</sup></li> </ul>	45 min	1 h	61
	W15d	<ul style="list-style-type: none"> <li>• W15 with</li> <li>• 89 mm thick absorptive material on one side only<sup>(6)(13)</sup></li> <li>• 15.9 mm Type X gypsum board<sup>(7)</sup></li> </ul>	1.5 h	2 h	62
	W15e	<ul style="list-style-type: none"> <li>• W15 with</li> <li>• 89 mm thick absorptive material on one side only<sup>(6)(13)</sup></li> <li>• 12.7 mm Type X gypsum board<sup>(7)</sup></li> </ul>	1 h	1.5 h	60
	W15f	<ul style="list-style-type: none"> <li>• W15 with</li> <li>• 89 mm thick absorptive material on one side only<sup>(6)(13)</sup></li> <li>• 12.7 mm regular gypsum board<sup>(7)</sup></li> </ul>	45 min	1 h	57
	W15g	<ul style="list-style-type: none"> <li>• W15 with</li> <li>• no absorptive material</li> <li>• 15.9 mm Type X gypsum board<sup>(7)</sup></li> </ul>	1.5 h	2 h	56
	W15h	<ul style="list-style-type: none"> <li>• W15 with</li> <li>• no absorptive material</li> <li>• 12.7 mm Type X gypsum board<sup>(7)</sup></li> </ul>	1 h	1.5 h	55
	W15i	<ul style="list-style-type: none"> <li>• W15 with</li> <li>• no absorptive material</li> <li>• 12.7 mm regular gypsum board<sup>(7)</sup></li> </ul>	45 min	1 h	51
	<b>W16</b>	<ul style="list-style-type: none"> <li>• two rows 38 mm x 89 mm studs, each spaced 400 mm or 600 mm o.c. on separate 38 mm x 89 mm plates set 25 mm apart</li> <li>• resilient metal channels on one side spaced 400 mm or 600 mm o.c.</li> <li>• with or without absorptive material</li> <li>• 2 layers of gypsum board on each side</li> </ul>	 GG00046B		
	W16a	<ul style="list-style-type: none"> <li>• W16 with</li> <li>• 89 mm thick absorptive material on each side<sup>(6)(13)</sup></li> <li>• 15.9 mm Type X gypsum board<sup>(7)</sup></li> </ul>	1.5 h	2 h	66
	W16b	<ul style="list-style-type: none"> <li>• W16 with</li> <li>• studs spaced 400 mm o.c. with blocking at mid-height<sup>(10)</sup></li> <li>• 89 mm thick rock or slag fibre insulation on each side<sup>(11)</sup></li> </ul>	2 h	2 h	–

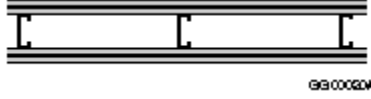
		<ul style="list-style-type: none"> <li>resilient metal channels on one side spaced 400 mm o.c.</li> <li>15.9 mm Type X gypsum board<sup>(7)(14)</sup></li> </ul>			
	W16c	<ul style="list-style-type: none"> <li>W16 with</li> <li>89 mm thick absorptive material on each side<sup>(6)(13)</sup></li> <li>12.7 mm Type X gypsum board<sup>(7)</sup></li> </ul>	1 h	1.5 h	65
	W16d	<ul style="list-style-type: none"> <li>W16 with</li> <li>89 mm thick absorptive material on one side only<sup>(6)(13)</sup></li> <li>15.9 mm Type X gypsum board<sup>(7)</sup></li> </ul>	1.5 h	2 h	62
	W16e	<ul style="list-style-type: none"> <li>W16 with</li> <li>89 mm thick absorptive material on one side only<sup>(6)(13)</sup></li> <li>12.7 mm Type X gypsum board<sup>(7)</sup></li> </ul>	1 h	1.5 h	60
	W16f	<ul style="list-style-type: none"> <li>W16 with</li> <li>no absorptive material</li> <li>15.9 mm Type X gypsum board<sup>(7)</sup></li> </ul>	1.5 h	2 h	56
	W16g	<ul style="list-style-type: none"> <li>W16 with</li> <li>no absorptive material</li> <li>12.7 mm Type X gypsum board<sup>(7)</sup></li> </ul>	1 h	1.5 h	55
<ul style="list-style-type: none"> <li>Exterior</li> <li>Wood Studs</li> <li>Single Row</li> <li>Loadbearing or Non-Loadbearing</li> </ul>	<b>EW1</b>	<ul style="list-style-type: none"> <li>wood studs</li> <li>rock or slag fibre insulation<sup>(11)</sup></li> <li>1 layer of gypsum board on inside</li> <li>exterior sheathing and cladding</li> </ul>			
	EW1a	<ul style="list-style-type: none"> <li>EW1 with</li> <li>38 mm x 89 mm studs spaced 400 mm or 600 mm o.c.</li> <li>15.9 mm Type X gypsum board<sup>(7)(15)(16)</sup></li> <li>exterior OSB or plywood sheathing<sup>(17)</sup> or exterior gypsum sheathing<sup>(18)</sup> and cladding<sup>(19)</sup></li> </ul>	1 h	1 h	n/a
	EW1b	<ul style="list-style-type: none"> <li>EW1 with</li> <li>38 mm x 89 mm studs spaced 400 mm or 600 mm o.c.</li> <li>15.9 mm Type X gypsum board<sup>(7)(15)</sup></li> <li>exterior OSB or plywood sheathing<sup>(17)</sup> or exterior gypsum sheathing<sup>(18)</sup> and cladding<sup>(19)</sup></li> </ul>	45 min	1 h	n/a
	EW1c	<ul style="list-style-type: none"> <li>EW1 with</li> <li>38 mm x 89 mm studs spaced 400 mm or 600 mm o.c.</li> <li>12.7 mm Type X gypsum board<sup>(7)(15)(16)</sup></li> <li>exterior OSB or plywood sheathing<sup>(17)</sup> or exterior gypsum sheathing<sup>(18)</sup> and cladding<sup>(19)</sup></li> </ul>	45 min	1 h	n/a
	EW1d	<ul style="list-style-type: none"> <li>EW1 with</li> <li>38 mm x 89 mm studs spaced 400 mm or 600 mm o.c.</li> <li>12.7 mm Type X gypsum board<sup>(7)(15)</sup></li> <li>exterior OSB or plywood sheathing<sup>(17)</sup> or exterior gypsum sheathing<sup>(18)</sup> and cladding<sup>(19)</sup></li> </ul>	–	45 min	n/a
	EW1e	<ul style="list-style-type: none"> <li>EW1 with</li> <li>38 mm x 140 mm studs spaced 400 mm o.c.</li> <li>15.9 mm Type X gypsum board<sup>(7)(15)(16)</sup></li> <li>exterior wood sheathing, exterior gypsum sheathing, or insulated exterior sheathing<sup>(20)</sup></li> </ul>	45 min	45 min	n/a

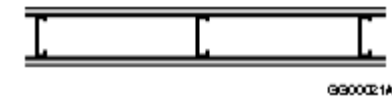
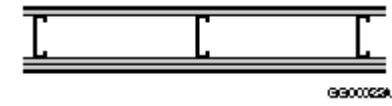
		<ul style="list-style-type: none"> <li>• masonry veneer cladding not less than 89 mm thick</li> </ul>			
	<b>EW2</b>	<ul style="list-style-type: none"> <li>• wood studs</li> <li>• glass fibre insulation<sup>(21)</sup></li> <li>• 1 layer of gypsum board on inside</li> <li>• exterior sheathing and cladding</li> </ul>			
	EW2a	EW2 with <ul style="list-style-type: none"> <li>• 38 mm x 89 mm studs spaced 400 mm o.c.</li> <li>• 15.9 mm Type X gypsum board<sup>(7),(15),(22)</sup></li> <li>• exterior OSB or plywood sheathing<sup>(17)</sup> or exterior gypsum sheathing<sup>(23)</sup> and cladding<sup>(19)</sup></li> </ul>	1 h	1 h	n/a
	EW2b	EW2 with <ul style="list-style-type: none"> <li>• 38 mm x 89 mm studs spaced 400 mm or 600 mm o.c.</li> <li>• 15.9 mm Type X gypsum board<sup>(7),(15),(16)</sup></li> <li>• exterior OSB or plywood sheathing<sup>(17)</sup> or exterior gypsum sheathing<sup>(18)</sup> and cladding<sup>(19)</sup></li> </ul>	45 min	1 h	n/a
	EW2c	EW2 with <ul style="list-style-type: none"> <li>• 38 mm x 89 mm studs spaced at 400 mm o.c.</li> <li>• 15.9 mm Type X gypsum board<sup>(7),(15)</sup></li> <li>• exterior OSB or plywood sheathing<sup>(17)</sup> and cladding<sup>(19)</sup></li> </ul>	45 min	1 h	n/a
	EW2d	EW2 with <ul style="list-style-type: none"> <li>• 38 mm x 89 mm studs spaced at 600 mm o.c.</li> <li>• 15.9 mm Type X gypsum board<sup>(7),(15)</sup></li> <li>• exterior OSB or plywood sheathing<sup>(17)</sup> and cladding<sup>(19)</sup></li> </ul>	–	45 min	n/a
	EW2e	EW2 with <ul style="list-style-type: none"> <li>• 38 mm x 89 mm studs spaced 400 mm or 600 mm o.c.</li> <li>• 15.9 mm Type X gypsum board<sup>(7),(15)</sup></li> <li>• exterior gypsum sheathing<sup>(18)</sup> and cladding<sup>(19)</sup></li> </ul>	–	45 min	n/a
	EW2f	EW2 with <ul style="list-style-type: none"> <li>• 38 mm x 89 mm studs spaced at 400 mm o.c.</li> <li>• 12.7 mm Type X gypsum board<sup>(7),(15),(16)</sup></li> <li>• exterior OSB or plywood sheathing<sup>(17)</sup> and cladding<sup>(19)</sup></li> </ul>	45 min	1 h	n/a
	EW2g	EW2 with <ul style="list-style-type: none"> <li>• 38 mm x 89 mm studs spaced at 600 mm o.c.</li> <li>• 12.7 mm Type X gypsum board<sup>(7),(15),(16)</sup></li> <li>• exterior OSB or plywood sheathing<sup>(17)</sup> and cladding<sup>(19)</sup></li> </ul>	–	45 min	n/a
	EW2h	EW2 with <ul style="list-style-type: none"> <li>• 38 mm x 89 mm studs spaced 400 mm or 600 mm o.c.</li> <li>• 12.7 mm Type X gypsum board<sup>(7),(15),(16)</sup></li> <li>• exterior gypsum sheathing<sup>(18)</sup> and cladding<sup>(19)</sup></li> </ul>	–	45 min	n/a
	EW2i	EW2 with <ul style="list-style-type: none"> <li>• 38 mm x 89 mm studs spaced at 400 mm o.c.</li> <li>• 12.7 mm Type X gypsum board<sup>(7),(15)</sup></li> <li>• exterior OSB or plywood sheathing<sup>(17)</sup> and cladding<sup>(19)</sup></li> </ul>	–	45 min	n/a
	EW2j	EW2 with <ul style="list-style-type: none"> <li>• 38 mm x 140 mm studs spaced at 400 mm o.c.</li> <li>• 15.9 mm Type X gypsum board<sup>(7),(15),(16)</sup></li> </ul>	45 min	45 min	n/a

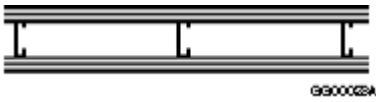
		<ul style="list-style-type: none"> <li>• exterior wood sheathing, exterior gypsum sheathing or insulated exterior sheathing<sup>(20)</sup></li> <li>• masonry veneer cladding not less than 89 mm thick</li> </ul>			
	<b>EW3</b>	<ul style="list-style-type: none"> <li>• wood studs</li> <li>• dry-blown cellulose fibre insulation<sup>(12)</sup></li> <li>• 1 layer of gypsum board on inside</li> <li>• exterior sheathing and cladding</li> </ul>			
	EW3a	EW3 with <ul style="list-style-type: none"> <li>• 38 mm x 89 mm studs spaced at 400 mm o.c.</li> <li>• 15.9 mm Type X gypsum board<sup>(7)(15)(16)</sup></li> <li>• exterior OSB or plywood sheathing<sup>(17)</sup> or exterior gypsum sheathing<sup>(18)</sup> and cladding<sup>(19)</sup></li> </ul>	1 h	1 h	n/a
	EW3b	EW3 with <ul style="list-style-type: none"> <li>• 38 mm x 89 mm studs spaced at 600 mm o.c.</li> <li>• 15.9 mm Type X gypsum board<sup>(7)(15)(16)</sup></li> <li>• exterior OSB or plywood sheathing<sup>(17)</sup> and cladding<sup>(19)</sup></li> </ul>	1 h	1 h	n/a
	EW3c	EW3 with <ul style="list-style-type: none"> <li>• 38 mm x 89 mm studs spaced at 600 mm o.c.</li> <li>• 15.9 mm Type X gypsum board<sup>(7)(15)(16)</sup></li> <li>• exterior gypsum sheathing<sup>(18)</sup> and cladding<sup>(19)</sup></li> </ul>	45 min	1 h	n/a
	EW3d	EW3 with <ul style="list-style-type: none"> <li>• 38 mm x 89 mm studs spaced at 400 mm o.c.</li> <li>• 15.9 mm Type X gypsum board<sup>(7)(15)</sup></li> <li>• exterior OSB or plywood sheathing<sup>(17)</sup> or exterior gypsum sheathing<sup>(18)</sup> and cladding<sup>(19)</sup></li> </ul>	45 min	1 h	n/a
	EW3e	EW3 with <ul style="list-style-type: none"> <li>• 38 mm x 89 mm studs spaced at 600 mm o.c.</li> <li>• 15.9 mm Type X gypsum board<sup>(7)(15)</sup></li> <li>• exterior OSB or plywood sheathing<sup>(17)</sup> and cladding<sup>(19)</sup></li> </ul>	45 min	1 h	n/a
	EW3f	EW3 with <ul style="list-style-type: none"> <li>• 38 mm x 89 mm studs spaced at 400 mm o.c.</li> <li>• 12.7 mm Type X gypsum board<sup>(7)(15)(16)</sup></li> <li>• exterior OSB or plywood sheathing<sup>(17)</sup> or exterior gypsum sheathing<sup>(18)</sup> and cladding<sup>(19)</sup></li> </ul>	45 min	1 h	n/a
	EW3g	EW3 with <ul style="list-style-type: none"> <li>• 38 mm x 89 mm studs spaced at 600 mm o.c.</li> <li>• 12.7 mm Type X gypsum board<sup>(7)(15)(16)</sup></li> <li>• exterior OSB or plywood sheathing<sup>(17)</sup> and cladding<sup>(19)</sup></li> </ul>	45 min	1 h	n/a
	EW3h	EW3 with <ul style="list-style-type: none"> <li>• 38 mm x 89 mm studs spaced at 600 mm o.c.</li> <li>• 12.7 mm Type X gypsum board<sup>(7)(15)(16)</sup></li> <li>• exterior gypsum sheathing<sup>(18)</sup> and cladding<sup>(19)</sup></li> </ul>	–	45 min	n/a
	EW3i	EW3 with <ul style="list-style-type: none"> <li>• 38 mm x 89 mm studs spaced at 400 mm o.c.</li> <li>• 12.7 mm Type X gypsum board<sup>(7)(15)</sup></li> <li>• exterior OSB or plywood sheathing<sup>(17)</sup> or exterior gypsum sheathing<sup>(18)</sup> and cladding<sup>(19)</sup></li> </ul>	–	45 min	n/a
	EW3j	EW3 with <ul style="list-style-type: none"> <li>• 38 mm x 89 mm studs spaced at 600 mm o.c.</li> <li>• 12.7 mm Type X gypsum board<sup>(7)(15)</sup></li> <li>• exterior OSB or plywood sheathing<sup>(17)</sup> and cladding<sup>(19)</sup></li> </ul>	–	45 min	n/a

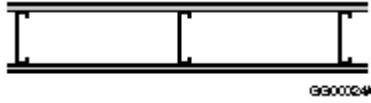
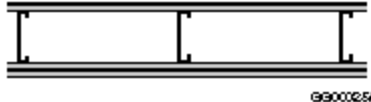
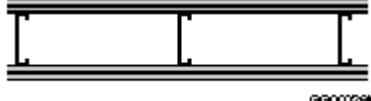
	EW3k	EW3 with <ul style="list-style-type: none"> <li>• 38 mm x 140 mm studs spaced at 400 mm o.c.</li> <li>• 15.9 mm Type X gypsum board<sup>(7),(15),(16)</sup></li> <li>• exterior wood sheathing, exterior gypsum sheathing or insulated exterior sheathing<sup>(20)</sup></li> <li>• masonry veneer cladding not less than 89 mm thick</li> </ul>	45 min	45 min	n/a
• Non-Loadbearing Steel Studs	<b>S1</b>	<ul style="list-style-type: none"> <li>• 31 mm x 64 mm steel studs spaced 400 mm or 600 mm o.c.</li> <li>• with or without absorptive material</li> <li>• 1 layer of gypsum board on each side</li> </ul>			
• 0.46 mm (25 Gauge)	S1a	S1 with <ul style="list-style-type: none"> <li>• studs spaced 600 mm o.c.</li> <li>• 65 mm thick absorptive material<sup>(6)</sup></li> <li>• 15.9 mm Type X gypsum board<sup>(7)</sup></li> </ul>	-	45 min [1 h <sup>(8)</sup> ]	43
	S1b	S1 with <ul style="list-style-type: none"> <li>• studs spaced 400 mm o.c.</li> <li>• 65 mm thick absorptive material<sup>(6)</sup></li> <li>• 15.9 mm Type X gypsum board<sup>(7)</sup></li> </ul>	-	45 min [1 h <sup>(8)</sup> ]	39
	S1c	S1 with <ul style="list-style-type: none"> <li>• studs spaced 400 mm or 600 mm o.c.</li> <li>• no absorptive material</li> <li>• 15.9 mm Type X gypsum board<sup>(7)</sup></li> </ul>	-	45 min	35
	<b>S2</b>	<ul style="list-style-type: none"> <li>• 31 mm x 64 mm steel studs spaced 400 mm or 600 mm o.c.</li> <li>• with or without absorptive material</li> <li>• 1 layer of gypsum board on one side</li> <li>• 2 layers of gypsum board on other side</li> </ul>			
	S2a	S2 with <ul style="list-style-type: none"> <li>• studs spaced 600 mm o.c.</li> <li>• 65 mm thick absorptive material<sup>(6)</sup></li> <li>• 15.9 mm Type X gypsum board<sup>(7)</sup></li> </ul>	-	1 h	50
	S2b	S2 with <ul style="list-style-type: none"> <li>• studs spaced 400 mm o.c.</li> <li>• 65 mm thick absorptive material<sup>(6)</sup></li> <li>• 15.9 mm Type X gypsum board<sup>(7)</sup></li> </ul>	-	1 h	44
	S2c	S2 with <ul style="list-style-type: none"> <li>• studs spaced 600 mm o.c.</li> <li>• 65 mm thick absorptive material<sup>(6)</sup></li> <li>• 12.7 mm Type X gypsum board<sup>(7)</sup></li> </ul>	-	1 h	50
	S2d	S2 with <ul style="list-style-type: none"> <li>• studs spaced 400 mm o.c.</li> <li>• 65 mm thick absorptive material<sup>(6)</sup></li> <li>• 12.7 mm Type X gypsum board<sup>(7)</sup></li> </ul>	-	1 h	42
	S2e	S2 with <ul style="list-style-type: none"> <li>• studs spaced 600 mm o.c.</li> <li>• no absorptive material</li> <li>• 15.9 mm Type X gypsum board<sup>(7)</sup></li> </ul>	-	1 h	41
	S2f	S2 with <ul style="list-style-type: none"> <li>• studs spaced 400 mm o.c.</li> <li>• no absorptive material</li> <li>• 15.9 mm Type X gypsum board<sup>(7)</sup></li> </ul>	-	1 h	37
	S2g	S2 with <ul style="list-style-type: none"> <li>• studs spaced 600 mm o.c.</li> </ul>	-	1 h	40


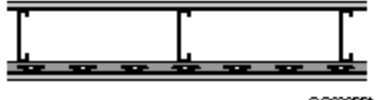


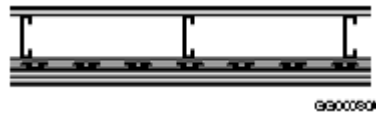
		<ul style="list-style-type: none"> <li>no absorptive material</li> <li>12.7 mm Type X gypsum board<sup>(7)</sup></li> </ul>			
	S2h	<ul style="list-style-type: none"> <li>S2 with</li> <li>studs spaced 400 mm o.c.</li> <li>no absorptive material</li> <li>12.7 mm Type X gypsum board<sup>(7)</sup></li> </ul>	-	1 h	35
	<b>S3</b>	<ul style="list-style-type: none"> <li>31 mm × 64 mm steel studs spaced 400 mm or 600 mm o.c.</li> <li>with or without absorptive material</li> <li>2 layers of gypsum board on each side</li> </ul>			
	S3a	<ul style="list-style-type: none"> <li>S3 with</li> <li>studs spaced 600 mm o.c.</li> <li>65 mm thick absorptive material<sup>(6)</sup></li> <li>15.9 mm Type X gypsum board<sup>(7)</sup></li> </ul>	-	2 h	54
	S3b	<ul style="list-style-type: none"> <li>S3 with</li> <li>studs spaced 400 mm o.c.</li> <li>65 mm thick absorptive material<sup>(6)</sup></li> <li>15.9 mm Type X gypsum board<sup>(7)</sup></li> </ul>	-	2 h	51
	S3c	<ul style="list-style-type: none"> <li>S3 with</li> <li>studs spaced 600 mm o.c.</li> <li>65 mm thick absorptive material<sup>(6)</sup></li> <li>12.7 mm Type X gypsum board<sup>(7)</sup></li> </ul>	-	1.5 h	53
	S3d	<ul style="list-style-type: none"> <li>S3 with</li> <li>studs spaced 400 mm o.c.</li> <li>65 mm thick absorptive material<sup>(6)</sup></li> <li>12.7 mm Type X gypsum board<sup>(7)</sup></li> </ul>	-	1.5 h	47
	S3e	<ul style="list-style-type: none"> <li>S3 with</li> <li>studs spaced 600 mm o.c.</li> <li>65 mm thick absorptive material<sup>(6)</sup></li> <li>12.7 mm regular gypsum board<sup>(7)</sup></li> </ul>	-	1 h	49
	S3f	<ul style="list-style-type: none"> <li>S3 with</li> <li>studs spaced 400 mm o.c.</li> <li>65 mm thick absorptive material<sup>(6)</sup></li> <li>12.7 mm regular gypsum board<sup>(7)</sup></li> </ul>	-	1 h	41
	S3g	<ul style="list-style-type: none"> <li>S3 with</li> <li>studs spaced 600 mm o.c.</li> <li>no absorptive material</li> <li>15.9 mm Type X gypsum board<sup>(7)</sup></li> </ul>	-	2 h	45
	S3h	<ul style="list-style-type: none"> <li>S3 with</li> <li>studs spaced 400 mm o.c.</li> <li>no absorptive material</li> <li>15.9 mm Type X gypsum board<sup>(7)</sup></li> </ul>	-	2 h	42
	S3i	<ul style="list-style-type: none"> <li>S3 with</li> <li>studs spaced 600 mm o.c.</li> <li>no absorptive material</li> <li>12.7 mm Type X gypsum board<sup>(7)</sup></li> </ul>	-	1.5 h	44
	S3j	<ul style="list-style-type: none"> <li>S3 with</li> <li>studs spaced 400 mm o.c.</li> <li>no absorptive material</li> <li>12.7 mm Type X gypsum board<sup>(7)</sup></li> </ul>	-	1.5 h	39
	S3k	<ul style="list-style-type: none"> <li>S3 with</li> <li>studs spaced 600 mm o.c.</li> <li>no absorptive material</li> <li>12.7 mm regular gypsum board<sup>(7)</sup></li> </ul>	-	1 h	40

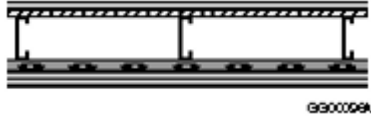
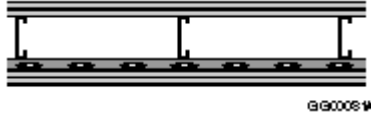
	S3l	S3 with • studs spaced 400 mm o.c. • no absorptive material • 12.7 mm regular gypsum board <sup>(7)</sup>	-	1 h	37
	<b>S4</b>	• 31 mm × 92 mm steel studs spaced 400 mm or 600 mm o.c. • with or without absorptive material • 1 layer of gypsum board on each side			
	S4a	S4 with • studs spaced 600 mm o.c. • 89 mm thick absorptive material <sup>(6)</sup> • 15.9 mm Type X gypsum board <sup>(7)</sup>	-	45 min [1 h <sup>(8)</sup> ]	48
	S4b	S4 with • studs spaced 400 mm o.c. • 89 mm thick absorptive material <sup>(6)</sup> • 15.9 mm Type X gypsum board <sup>(7)</sup>	-	45 min [1 h <sup>(8)</sup> ]	47
	S4c	S4 with • studs spaced 600 mm o.c. • no absorptive material • 15.9 mm Type X gypsum board <sup>(7)</sup>	-	45 min	38
	S4d	S4 with • studs spaced 400 mm o.c. • no absorptive material • 15.9 mm Type X gypsum board <sup>(7)</sup>	-	45 min	38
	<b>S5</b>	• 31 mm × 92 mm steel studs spaced 400 mm or 600 mm o.c. • with or without absorptive material • 1 layer of gypsum board on one side • 2 layers of gypsum board on other side			
	S5a	S5 with • studs spaced 600 mm o.c. • 89 mm thick absorptive material <sup>(6)</sup> • 15.9 mm Type X gypsum board <sup>(7)</sup>	-	1 h [1.5 h <sup>(8)</sup> ]	53
	S5b	S5 with • studs spaced 400 mm o.c. • 89 mm thick absorptive material <sup>(6)</sup> • 15.9 mm Type X gypsum board <sup>(7)</sup>	-	1 h [1.5 h <sup>(8)</sup> ]	52
	S5c	S5 with • studs spaced 600 mm o.c. • 89 mm thick absorptive material <sup>(6)</sup> • 12.7 mm Type X gypsum board <sup>(7)</sup>	-	1 h [1.5 h <sup>(8)</sup> ]	51
	S5d	S5 with • studs spaced 400 mm o.c. • 89 mm thick absorptive material <sup>(6)</sup> • 12.7 mm Type X gypsum board <sup>(7)</sup>	-	1 h [1.5 h <sup>(8)</sup> ]	50
	S5e	S5 with • studs spaced 600 mm o.c. • no absorptive material • 15.9 mm Type X gypsum board <sup>(7)</sup>	-	1 h	43
	S5f	S5 with • studs spaced 400 mm o.c. • no absorptive material • 15.9 mm Type X gypsum board <sup>(7)</sup>	-	1 h	42
	S5g	S5 with • studs spaced 600 mm o.c.	-	1 h	41


		<ul style="list-style-type: none"> <li>no absorptive material</li> <li>12.7 mm Type X gypsum board<sup>(7)</sup></li> </ul>			
	S5h	<ul style="list-style-type: none"> <li>S5 with</li> <li>studs spaced 400 mm o.c.</li> <li>no absorptive material</li> <li>12.7 mm Type X gypsum board<sup>(7)</sup></li> </ul>	-	1 h	40
	<b>S6</b>	<ul style="list-style-type: none"> <li>31 mm × 92 mm steel studs spaced 400 mm or 600 mm o.c.</li> <li>with or without absorptive material</li> <li>2 layers of gypsum board on each side</li> </ul>			
	S6a	<ul style="list-style-type: none"> <li>S6 with</li> <li>studs spaced 600 mm o.c.</li> <li>89 mm thick absorptive material<sup>(6)</sup></li> <li>15.9 mm Type X gypsum board<sup>(7)</sup></li> </ul>	-	2 h	56
	S6b	<ul style="list-style-type: none"> <li>S6 with</li> <li>studs spaced 400 mm o.c.</li> <li>89 mm thick absorptive material<sup>(6)</sup></li> <li>15.9 mm Type X gypsum board<sup>(7)</sup></li> </ul>	-	2 h	55
	S6c	<ul style="list-style-type: none"> <li>S6 with</li> <li>studs spaced 600 mm o.c.</li> <li>89 mm thick absorptive material<sup>(6)</sup></li> <li>12.7 mm Type X gypsum board<sup>(7)</sup></li> </ul>	-	1.5 h	55
	S6d	<ul style="list-style-type: none"> <li>S6 with</li> <li>studs spaced 400 mm o.c.</li> <li>89 mm thick absorptive material<sup>(6)</sup></li> <li>12.7 mm Type X gypsum board<sup>(7)</sup></li> </ul>	-	1.5 h	54
	S6e	<ul style="list-style-type: none"> <li>S6 with</li> <li>studs spaced 600 mm o.c.</li> <li>89 mm thick absorptive material<sup>(6)</sup></li> <li>12.7 mm regular gypsum board<sup>(7)</sup></li> </ul>	-	1 h	50
	S6f	<ul style="list-style-type: none"> <li>S6 with</li> <li>studs spaced 400 mm o.c.</li> <li>89 mm thick absorptive material<sup>(6)</sup></li> <li>12.7 mm regular gypsum board<sup>(7)</sup></li> </ul>	-	1 h	48
	S6g	<ul style="list-style-type: none"> <li>S6 with</li> <li>studs spaced 600 mm o.c.</li> <li>no absorptive material</li> <li>15.9 mm Type X gypsum board<sup>(7)</sup></li> </ul>	-	2 h	47
	S6h	<ul style="list-style-type: none"> <li>S6 with</li> <li>studs spaced 400 mm o.c.</li> <li>no absorptive material</li> <li>15.9 mm Type X gypsum board<sup>(7)</sup></li> </ul>	-	2 h	45
	S6i	<ul style="list-style-type: none"> <li>S6 with</li> <li>studs spaced 600 mm o.c.</li> <li>no absorptive material</li> <li>12.7 mm Type X gypsum board<sup>(7)</sup></li> </ul>	-	1.5 h	45
	S6j	<ul style="list-style-type: none"> <li>S6 with</li> <li>studs spaced 400 mm o.c.</li> <li>no absorptive material</li> <li>12.7 mm Type X gypsum board<sup>(7)</sup></li> </ul>	-	1.5 h	44
	S6k	<ul style="list-style-type: none"> <li>S6 with</li> <li>studs spaced 600 mm o.c.</li> <li>no absorptive material</li> <li>12.7 mm regular gypsum board<sup>(7)</sup></li> </ul>	-	1 h	41

	S6l	S6 with <ul style="list-style-type: none"> <li>• studs spaced 400 mm o.c.</li> <li>• no absorptive material</li> <li>• 12.7 mm regular gypsum board<sup>(7)</sup></li> </ul>	-	1 h	39
	<b>S7</b>	<ul style="list-style-type: none"> <li>• 31 mm × 152 mm steel studs spaced 400 mm or 600 mm o.c.</li> <li>• with or without absorptive material</li> <li>• 1 layer of gypsum board on each side</li> </ul>			
	S7a	S7 with <ul style="list-style-type: none"> <li>• 150 mm thick absorptive material<sup>(6)</sup></li> <li>• 15.9 mm Type X gypsum board<sup>(7)</sup></li> </ul>	-	45 min [1 h <sup>(8)</sup> ]	51
	S7b	S7 with <ul style="list-style-type: none"> <li>• no absorptive material</li> <li>• 15.9 mm Type X gypsum board<sup>(7)</sup></li> </ul>	-	45 min	41
	<b>S8</b>	<ul style="list-style-type: none"> <li>• 31 mm × 152 mm steel studs spaced 400 mm or 600 mm o.c.</li> <li>• with or without absorptive material</li> <li>• 1 layer of gypsum board on one side</li> <li>• 2 layers of gypsum board on other side</li> </ul>			
	S8a	S8 with <ul style="list-style-type: none"> <li>• 150 mm thick absorptive material<sup>(6)</sup></li> <li>• 15.9 mm Type X gypsum board<sup>(7)</sup></li> </ul>	-	1 h [1.5 h <sup>(8)</sup> ]	55
	S8b	S8 with <ul style="list-style-type: none"> <li>• 150 mm thick absorptive material<sup>(6)</sup></li> <li>• 12.7 mm Type X gypsum board<sup>(7)</sup></li> </ul>	-	1 h [1.5 h <sup>(8)</sup> ]	54
	S8c	S8 with <ul style="list-style-type: none"> <li>• no absorptive material</li> <li>• 15.9 mm Type X gypsum board<sup>(7)</sup></li> </ul>	-	1 h	45
	S8d	S8 with <ul style="list-style-type: none"> <li>• no absorptive material</li> <li>• 12.7 mm Type X gypsum board<sup>(7)</sup></li> </ul>	-	1 h	44
	<b>S9</b>	<ul style="list-style-type: none"> <li>• 31 mm × 152 mm steel studs spaced 400 mm or 600 mm o.c.</li> <li>• with or without absorptive material</li> <li>• 2 layers of gypsum board on each side</li> </ul>			
	S9a	S9 with <ul style="list-style-type: none"> <li>• 150 mm thick absorptive material<sup>(6)</sup></li> <li>• 15.9 mm Type X gypsum board<sup>(7)</sup></li> </ul>	-	2 h	59
	S9b	S9 with <ul style="list-style-type: none"> <li>• 150 mm thick absorptive material<sup>(6)</sup></li> <li>• 12.7 mm Type X gypsum board<sup>(7)</sup></li> </ul>	-	1.5 h	57
	S9c	S9 with <ul style="list-style-type: none"> <li>• 150 mm thick absorptive material<sup>(6)</sup></li> <li>• 12.7 mm regular gypsum board<sup>(7)</sup></li> </ul>	-	1 h	53
	S9d	S9 with <ul style="list-style-type: none"> <li>• no absorptive material</li> <li>• 15.9 mm Type X gypsum board<sup>(7)</sup></li> </ul>	-	2 h	49
	S9e	S9 with <ul style="list-style-type: none"> <li>• no absorptive material</li> <li>• 12.7 mm Type X gypsum board<sup>(7)</sup></li> </ul>	-	1.5 h	47
	S9f	S9 with <ul style="list-style-type: none"> <li>• no absorptive material</li> <li>• 12.7 mm regular gypsum board<sup>(7)</sup></li> </ul>	-	1 h	43

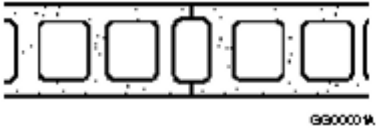
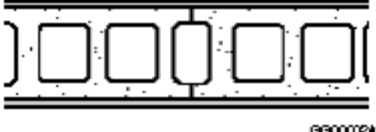
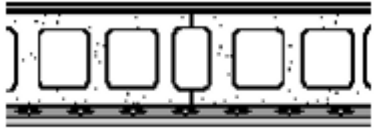
<ul style="list-style-type: none"> <li>• Loadbearing Steel Studs</li> <li>• 0.84 mm to 1.52 mm Thickness</li> </ul>	<b>S10</b>	<ul style="list-style-type: none"> <li>• 41 mm × 92 mm loadbearing steel studs spaced 400 mm or 600 mm o.c.</li> <li>• with or without cross-bracing on one side</li> <li>• with or without absorptive material</li> <li>• 2 layers gypsum board on each side</li> </ul>			
	S10a	S10 with <ul style="list-style-type: none"> <li>• 89 mm thick absorptive material<sup>(6)</sup></li> <li>• 15.9 mm Type X gypsum board<sup>(7)</sup></li> </ul>	1 h	–	38
	S10b	S10 with <ul style="list-style-type: none"> <li>• 89 mm thick absorptive material<sup>(6)</sup></li> <li>• 12.7 mm Type X gypsum board<sup>(7)</sup></li> </ul>	45 min [1 h]	–	38
	S10c	S10 with <ul style="list-style-type: none"> <li>• 89 mm thick absorptive material<sup>(6)</sup></li> <li>• 12.7 mm regular gypsum board<sup>(7)</sup></li> </ul>	–	–	36
	S10d	S10 with <ul style="list-style-type: none"> <li>• no absorptive material</li> <li>• 15.9 mm Type X gypsum board<sup>(7)</sup></li> </ul>	1 h	–	36
	S10e	S10 with <ul style="list-style-type: none"> <li>• no absorptive material</li> <li>• 12.7 mm Type X gypsum board<sup>(7)</sup></li> </ul>	1 h	–	35
	S10f	S10 with <ul style="list-style-type: none"> <li>• no absorptive material</li> <li>• 12.7 mm regular gypsum board<sup>(7)</sup></li> </ul>	–	–	34
	<b>S11</b>	<ul style="list-style-type: none"> <li>• 41 mm × 92 mm loadbearing steel studs spaced 400 mm or 600 mm o.c.</li> <li>• with or without cross-bracing on one side</li> <li>• with or without absorptive material</li> <li>• resilient metal channels on one side</li> <li>• 1 layer gypsum board on each side</li> </ul>			
	S11a	S11 with <ul style="list-style-type: none"> <li>• 89 mm thick absorptive material<sup>(6)</sup></li> <li>• resilient metal channels spaced at 600 mm o.c.</li> <li>• 15.9 mm Type X gypsum board<sup>(7)</sup></li> </ul>	–	–	50
	S11b	S11 with <ul style="list-style-type: none"> <li>• 89 mm thick absorptive material<sup>(6)</sup></li> <li>• resilient metal channels spaced at 400 mm o.c.</li> <li>• 15.9 mm Type X gypsum board<sup>(7)</sup></li> </ul>	–	–	47
	S11c	S11 with <ul style="list-style-type: none"> <li>• no absorptive material</li> <li>• resilient metal channels spaced at 600 mm o.c.</li> <li>• 15.9 mm Type X gypsum board<sup>(7)</sup></li> </ul>	–	–	41
	S11d	S11 with <ul style="list-style-type: none"> <li>• 89 mm thick absorptive material<sup>(6)</sup></li> <li>• resilient metal channels spaced at 600 mm o.c.</li> <li>• 12.7 mm Type X gypsum board<sup>(7)</sup></li> </ul>	–	–	47
	S11e	S11 with <ul style="list-style-type: none"> <li>• 89 mm thick absorptive material<sup>(6)</sup></li> <li>• resilient metal channels spaced at 400 mm o.c.</li> <li>• 12.7 mm Type X gypsum board<sup>(7)</sup></li> </ul>	–	–	45
	S11f	S11 with	–	–	39

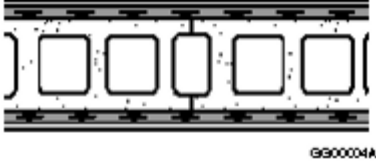
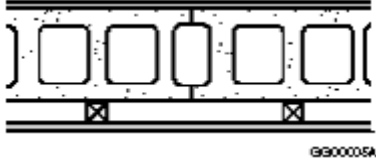
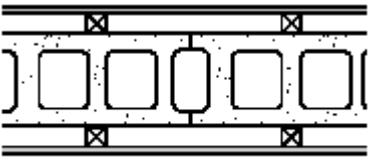
		<ul style="list-style-type: none"> <li>• no absorptive material<sup>(6)</sup></li> <li>• resilient metal channels spaced at 400 mm o.c.</li> <li>• 15.9 mm Type X gypsum board<sup>(7)</sup></li> </ul>			
	S11g	<ul style="list-style-type: none"> <li>• S11 with</li> <li>• no absorptive material<sup>(6)</sup></li> <li>• resilient metal channels spaced at 400 mm o.c.</li> <li>• 12.7 mm Type X gypsum board<sup>(7)</sup></li> </ul>	-	-	36
	S11h	<ul style="list-style-type: none"> <li>• S11 with</li> <li>• no absorptive material<sup>(6)</sup></li> <li>• resilient metal channels spaced at 600 mm o.c.</li> <li>• 12.7 mm Type X gypsum board<sup>(7)</sup></li> </ul>	-	-	38
	<b>S12</b>	<ul style="list-style-type: none"> <li>• 41 mm x 92 mm loadbearing steel studs spaced 400 mm or 600 mm o.c.</li> <li>• with or without cross-bracing on one side</li> <li>• with or without absorptive material</li> <li>• resilient metal channels on one side</li> <li>• 2 layers gypsum board on resilient channel side</li> <li>• 1 layer gypsum board on other side</li> </ul>			
	S12a	<ul style="list-style-type: none"> <li>• S12 with</li> <li>• 89 mm thick absorptive material<sup>(6)</sup></li> <li>• resilient metal channels spaced at 600 mm o.c.</li> <li>• 15.9 mm Type X gypsum board<sup>(7)</sup></li> </ul>	-	-	54
	S12b	<ul style="list-style-type: none"> <li>• S12 with</li> <li>• no absorptive material</li> <li>• resilient metal channels spaced at 600 mm o.c.</li> <li>• 15.9 mm Type X gypsum board<sup>(7)</sup></li> </ul>	-	-	46
	S12c	<ul style="list-style-type: none"> <li>• S12 with</li> <li>• 89 mm thick absorptive material<sup>(6)</sup></li> <li>• resilient metal channels spaced at 400 mm o.c.</li> <li>• 15.9 mm Type X gypsum board<sup>(7)</sup></li> </ul>	-	-	52
	S12d	<ul style="list-style-type: none"> <li>• S12 with</li> <li>• no absorptive material</li> <li>• resilient metal channels spaced at 400 mm o.c.</li> <li>• 15.9 mm Type X gypsum board<sup>(7)</sup></li> </ul>	-	-	43
	S12e	<ul style="list-style-type: none"> <li>• S12 with</li> <li>• 89 mm thick absorptive material<sup>(6)</sup></li> <li>• resilient metal channels spaced at 600 mm o.c.</li> <li>• 12.7 mm Type X gypsum board<sup>(7)</sup></li> </ul>	-	-	52
	S12f	<ul style="list-style-type: none"> <li>• S12 with</li> <li>• no absorptive material</li> <li>• resilient metal channels spaced at 600 mm o.c.</li> <li>• 12.7 mm Type X gypsum board<sup>(7)</sup></li> </ul>	-	-	43
	S12g	<ul style="list-style-type: none"> <li>• S12 with</li> <li>• 89 mm thick absorptive material<sup>(6)</sup></li> <li>• resilient metal channels spaced at 400 mm o.c.</li> </ul>	-	-	50

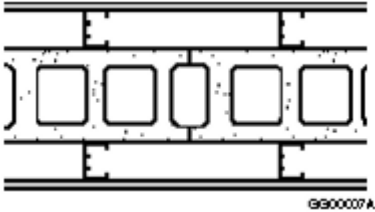
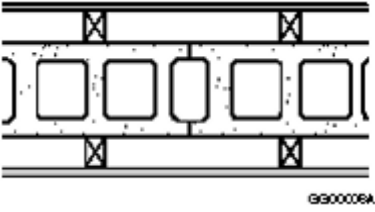
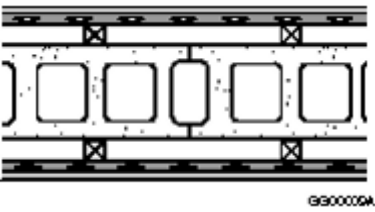
		<ul style="list-style-type: none"> <li>• 12.7 mm Type X gypsum board<sup>(7)</sup></li> </ul>			
	S12h	<ul style="list-style-type: none"> <li>• S12 with</li> <li>• no absorptive material</li> <li>• resilient metal channels spaced at 400 mm o.c.</li> <li>• 12.7 mm Type X gypsum board<sup>(7)</sup></li> </ul>	–	–	41
	<b>S13</b>	<ul style="list-style-type: none"> <li>• 41 mm × 92 mm loadbearing steel studs spaced 400 mm or 600 mm o.c.</li> <li>• with or without absorptive material</li> <li>• resilient metal channels on one side spaced at 400 mm o.c.</li> <li>• 2 layers gypsum board on resilient channel side</li> <li>• 1 layer shear membrane and 1 layer gypsum board on other side</li> </ul>			
	S13a	<ul style="list-style-type: none"> <li>• S13 with</li> <li>• 89 mm thick absorptive material<sup>(6)</sup></li> <li>• 12.7 mm OSB shear membrane</li> <li>• 12.7 mm Type X gypsum board<sup>(7)</sup></li> </ul>	30 min	–	57
	<b>S14</b>	<ul style="list-style-type: none"> <li>• 41 mm × 92 mm loadbearing steel studs spaced 400 mm or 600 mm o.c.</li> <li>• with or without absorptive material</li> <li>• resilient metal channels on one side</li> <li>• 2 layers gypsum board on each side</li> </ul>			
	S14a	<ul style="list-style-type: none"> <li>• S14 with</li> <li>• 89 mm thick absorptive material<sup>(6)</sup></li> <li>• resilient metal channels spaced at 600 mm o.c.</li> <li>• 15.9 mm Type X gypsum board<sup>(7)</sup></li> </ul>	1 h	–	60
	S14b	<ul style="list-style-type: none"> <li>• S14 with</li> <li>• 89 mm thick absorptive material<sup>(6)</sup></li> <li>• resilient metal channels spaced at 600 mm o.c.</li> <li>• 12.7 mm Type X gypsum board<sup>(7)</sup></li> </ul>	45 min [1 h]	–	57
	S14c	<ul style="list-style-type: none"> <li>• S14 with</li> <li>• 89 mm thick absorptive material<sup>(6)</sup></li> <li>• resilient metal channels spaced at 600 mm o.c.</li> <li>• 12.7 mm regular gypsum board<sup>(7)</sup></li> </ul>	–	–	54
	S14d	<ul style="list-style-type: none"> <li>• S14 with</li> <li>• no absorptive material</li> <li>• resilient metal channels spaced at 600 mm o.c.</li> <li>• 15.9 mm Type X gypsum board<sup>(7)</sup></li> </ul>	1 h	–	51
	S14e	<ul style="list-style-type: none"> <li>• S14 with</li> <li>• studs at 400 mm o.c.</li> <li>• no absorptive material</li> <li>• resilient metal channels spaced at 600 mm o.c.</li> <li>• 12.7 mm Type X gypsum board<sup>(7)</sup></li> </ul>	1 h	–	49
	S14f	<ul style="list-style-type: none"> <li>• S14 with</li> <li>• studs at 600 mm o.c.</li> <li>• no absorptive material</li> <li>• resilient metal channels spaced at 600 mm o.c.</li> <li>• 12.7 mm regular gypsum board<sup>(7)</sup></li> </ul>	1 h	–	50


	S14g	S14 with • no absorptive material • resilient metal channels spaced at 600 mm o.c. • 12.7 mm regular gypsum board <sup>(7)</sup>	–	–	45
	S14h	S14 with • studs at 400 mm o.c. • 89 mm thick absorptive material <sup>(6)</sup> • resilient metal channels spaced at 400 mm o.c. • 15.9 mm Type X gypsum board <sup>(7)</sup>	1 h	–	58
	S14i	S14 with • studs at 600 mm o.c. • 89 mm thick absorptive material <sup>(6)</sup> • resilient metal channels spaced at 400 mm o.c. • 15.9 mm Type X gypsum board <sup>(7)</sup>	1 h	–	60
	S14j	S14 with • 89 mm thick absorptive material <sup>(6)</sup> • resilient metal channels spaced at 400 mm o.c. • 12.7 mm Type X gypsum board <sup>(7)</sup>	45 min [1 h]	–	55
	S14k	S14 with • studs at 400 mm o.c. • no absorptive material • resilient metal channels spaced at 400 mm o.c. • 15.9 mm Type X gypsum board <sup>(7)</sup>	1 h	–	49
	S14l	S14 with • studs at 600 mm o.c. • no absorptive material • resilient metal channels spaced at 400 mm o.c. • 15.9 mm Type X gypsum board <sup>(7)</sup>	1 h	–	51
	S14m	S14 with • no absorptive material • resilient metal channels spaced at 400 mm o.c. • 12.7 mm Type X gypsum board <sup>(7)</sup>	1 h	–	47
	<b>S15</b>	• 2 rows of 92 mm loadbearing steel studs spaced 400 mm or 600 mm o.c. staggered on separate 41 mm x 92 mm runners • with cross-bracing • with or without absorptive material • 2 layers of gypsum board each side			
	S15a	S15 with • 89 mm thick absorptive material in each cavity <sup>(6)</sup> • 12.7 mm Type X gypsum board <sup>(7)</sup>	1 h	–	68
	S15b	S15 with • no absorptive material • 12.7 mm Type X gypsum board <sup>(7)</sup>	1 h	–	52
	S15c	S15 with • 89 mm thick absorptive material in each cavity <sup>(6)</sup> • 15.9 mm Type X gypsum board <sup>(7)</sup>	1 h	–	68



	S15d	S15 with • no absorptive material • 15.9 mm Type X gypsum board <sup>(7)</sup>	1.5 h	-	52
• Hollow Concrete Block (Normal Weight Aggregate)	<b>B1</b>	• 140 mm or 190 mm concrete block			
	B1a	• 140 mm bare concrete block <sup>(8)</sup>	1 h	1 h	48
	B1b	• 190 mm bare concrete block <sup>(8)</sup>	1.5 h	1.5 h	50
	<b>B2</b>	• 140 mm or 190 mm concrete block • no absorptive material • 1 layer gypsum-sand plaster or gypsum board on each side			
	B2a	B2 with • 140 mm concrete block • 12.7 mm gypsum-sand plaster	2 h	2 h	50
	B2b	B2 with • 140 mm concrete block • 12.7 mm Type X gypsum board or 15.9 mm Type X gypsum board <sup>(7)</sup>	2 h	2 h	47
	B2c	B2 with • 140 mm concrete block • 12.7 mm regular gypsum board <sup>(7)</sup>	1.5 h	1.5 h	46
	B2d	B2 with • 190 mm concrete block • 12.7 mm gypsum-sand plaster	2.5 h	2.5 h	51
	B2e	B2 with • 190 mm concrete block • 15.9 mm Type X gypsum board <sup>(7)</sup>	3 h	3 h	50
	B2f	B2 with • 190 mm concrete block • 12.7 mm Type X gypsum board <sup>(7)</sup>	2.5 h	2.5 h	49
	B2g	B2 with • 190 mm concrete block • 12.7 mm regular gypsum board <sup>(7)</sup>	2 h	2 h	48
	<b>B3</b>	• 140 mm or 190 mm concrete block • resilient metal channels on one side spaced at 400 mm or 600 mm o.c. • absorptive material filling resilient metal channel space <sup>(8)</sup> • 1 layer gypsum board on each side			
	B3a	B3 with • 140 mm concrete block • 12.7 mm Type X gypsum board or 15.9 mm Type X gypsum board <sup>(7)</sup>	2 h	2 h	51
	B3b	B3 with • 140 mm concrete block • 12.7 mm regular gypsum board <sup>(7)(9)</sup>	1.5 h	1.5 h	48
	B3c	B3 with • 190 mm concrete block • 15.9 mm Type X gypsum board <sup>(7)</sup>	3 h	3 h	54

	B3d	B3 with • 190 mm concrete block • 12.7 mm Type X gypsum board <sup>(7)</sup>	2.5 h	2.5 h	53
	B3e	B3 with • 190 mm concrete block • 12.7 mm regular gypsum board <sup>(7)(9)</sup>	2 h	2 h	51
	<b>B4</b>	• 140 mm or 190 mm concrete block • resilient metal channels on each side spaced at 400 mm or 600 mm o.c. • with or without absorptive material • 1 layer gypsum board on each side			
	B4a	B4 with • 140 mm concrete block • 12.7 mm Type X gypsum board <sup>(7)</sup> , or 15.9 mm Type X gypsum board <sup>(7)</sup>	2 h	2 h	47
	B4b	B4 with • 140 mm concrete block • 12.7 mm regular gypsum board <sup>(7)(9)</sup>	1.5 h	1.5 h	42
	B4c	B4 with • 190 mm concrete block • 15.9 mm Type X gypsum board <sup>(7)</sup>	3 h	3 h	50
	B4d	B4 with • 190 mm concrete block • 12.7 mm Type X gypsum board <sup>(7)</sup>	2.5 h	2.5 h	49
	B4e	B4 with • 190 mm concrete block • 12.7 mm regular gypsum board <sup>(7)(9)</sup>	2 h	2 h	45
	<b>B5</b>	• 190 mm concrete block • 38 mm × 38 mm horizontal or vertical wood strapping on one side spaced at 600 mm o.c. • with or without absorptive material • 1 layer gypsum board on each side			
	B5a	B5 with • 15.9 mm Type X gypsum board <sup>(7)</sup>	3 h	3 h	54
	B5b	B5 with • 12.7 mm Type X gypsum board <sup>(7)</sup>	2.5 h	2.5 h	53
	B5c	B5 with • 12.7 mm regular gypsum board <sup>(7)(9)</sup>	2 h	2 h	51
	<b>B6</b>	• 140 mm or 190 mm concrete block • 38 mm × 38 mm horizontal or vertical wood strapping on each side spaced at 600 mm o.c. • absorptive material filling strapping space on each side <sup>(6)</sup> • 1 layer gypsum board on each side			
	B6a	B6 with • 140 mm concrete block • 12.7 mm Type X gypsum board or 15.9 mm Type X gypsum board <sup>(7)</sup>	2 h	2 h	57
	B6b	B6 with • 140 mm concrete block • 12.7 mm regular gypsum board <sup>(7)(9)</sup>	1.5 h	1.5 h	56

	B6c	B6 with • 190 mm concrete block • 15.9 mm Type X gypsum board <sup>(7)</sup>	3 h	3 h	60
	B6d	B6 with • 190 mm concrete block • 12.7 mm Type X gypsum board <sup>(7)</sup>	2.5 h	2.5 h	59
	B6e	B6 with • 190 mm concrete block • 12.7 regular gypsum board <sup>(7)(9)</sup>	2 h	2 h	57
	<b>B7</b>	<ul style="list-style-type: none"> <li>• 190 mm concrete block</li> <li>• 65 mm steel studs each side spaced at 600 mm o.c.</li> <li>• absorptive material filling stud space on each side<sup>(6)</sup></li> <li>• 1 layer gypsum board on each side</li> </ul>			
	B7a	B7 with • 15.9 mm Type X gypsum board <sup>(7)</sup>	3 h	3 h	71
	B7b	B7 with • 12.7 mm Type X gypsum board <sup>(7)</sup>	2.5 h	2.5 h	70
	B7c	B7 with • 12.7 mm regular gypsum board <sup>(7)(9)</sup>	2 h	2 h	69
	<b>B8</b>	<ul style="list-style-type: none"> <li>• 190 mm concrete block</li> <li>• 38 mm x 64 mm wood studs on each side spaced at 600 mm o.c.</li> <li>• absorptive material filling stud space on each side<sup>(6)</sup></li> <li>• 1 layer gypsum board on each side</li> </ul>			
	B8a	B8 with • 15.9 mm Type X gypsum board <sup>(7)</sup>	3 h	3 h	71
	B8b	B8 with • 12.7 mm Type X gypsum board <sup>(7)</sup>	2.5 h	2.5 h	70
	B8c	B8 with • 12.7 mm regular gypsum board <sup>(7)(9)</sup>	2 h	2 h	69
	<b>B9</b>	<ul style="list-style-type: none"> <li>• 190 mm concrete block</li> <li>• 50 mm metal Z-bars on each side spaced at 600 mm o.c. (or 38 mm x 38 mm horizontal or vertical wood strapping plus resilient metal channels)</li> <li>• absorptive material filling Z-bar space on each side<sup>(6)</sup></li> <li>• 1 layer gypsum board on each side</li> </ul>			
	B9a	B9 with • 15.9 mm Type X gypsum board <sup>(7)</sup>	3 h	3 h	65
	B9b	B9 with • 12.7 mm Type X gypsum board <sup>(7)</sup>	2.5 h	2.5 h	64
	B9c	B9 with • 12.7 mm regular gypsum board <sup>(7)(9)</sup>	2 h	2 h	63

	<b>B10</b>	<ul style="list-style-type: none"> <li>• 190 mm concrete block</li> <li>• resilient metal channels on one side spaced at 600 mm o.c.</li> <li>• absorptive material filling resilient metal channel space<sup>(6)</sup></li> <li>• 2 layers gypsum board on one side only</li> </ul>			
	B10a	B10 with • 15.9 mm Type X gypsum board <sup>(7)</sup>	3 h	3 h	56
	B10b	B10 with • 12.7 mm Type X gypsum board <sup>(7)</sup>	2.5 h	2.5 h	55
	B10c	B10 with • 12.7 mm regular gypsum board <sup>(7)</sup>	2 h	2 h	54

**Notes to Table 9.10.3.1.-A:**

<sup>(1)</sup> See Note A-9.10.3.1.

<sup>(2)</sup> *Fire-resistance ratings* and *STC* ratings of wood-frame construction were evaluated only for constructions with solid-sawn 38 mm x 89 mm lumber. However, the *fire-resistance ratings* and *STC* ratings provided for 38 mm x 89 mm wood-frame construction may be applied to wood-frame constructions with solid-sawn 38 mm x 140 mm lumber; in some cases the ratings may be conservative. Where 38 mm x 140 mm framing is used and absorptive material is called for, the absorptive material must be 140 mm thick. (See

Sentence D-1.2.1.(2) of Appendix D for the significance of *fire-resistance ratings*.) The *STC* ratings may also be applied to fingerjoined lumber. The *fire-resistance ratings* are applicable to constructions using fingerjoined lumber that has been manufactured with a heat-resistant adhesive (HRA) in accordance with NLGA special product standard SPS-1, "Fingerjoined Structural Lumber," or SPS-3, "Fingerjoined "Vertical Stud Use Only" Lumber." (See also Note A-9.23.10.4.(1).)

<sup>(3)</sup> For all *fire-resistance ratings*, the given spacing for framing is a maximum value.

<sup>(4)</sup> Sound ratings listed are based on the most reliable laboratory test data available for specimens conforming to installation details required by CSA A82.31-M, "Gypsum Board Application." Results of specific tests may differ slightly because of measurement precision and minor variations in construction details. These results should only be used where the actual construction details, including spacing of fasteners and supporting framing, correspond exactly to the details of the test specimens on which the ratings are based. For wood- and steel-framed assemblies, if the fasteners are spaced less than 300 mm o.c., subtract 1 from the *sound transmission class* value; if the fasteners are spaced less than 200 mm o.c., subtract 2 from the *sound transmission class* value. Narrower fastener spacing is not detrimental to the *fire-resistance rating*. Assemblies with *sound transmission class* ratings of 50 or more require methods to minimize airborne sound transmission at electrical boxes and other openings, and at the junction of intersecting walls and floors, except intersection of walls constructed of concrete or *solid masonry units* where the masonry joints at the intersection are mortared.

<sup>(5)</sup> Sound ratings are only valid where there are no discernible cracks or voids in the visible surfaces. For concrete blocks, surfaces must be sealed by at least 2 coats of paint or other surface finish described in Section 9.29. to prevent sound leakage.

<sup>(6)</sup> Sound absorptive material includes fibre processed from rock, slag, glass or cellulose fibre. It must fill at least 90% of the cavity thickness for the wall to have the listed *STC* value. The absorptive material should not overfill the cavity to the point of producing significant outward pressure on the finishes; such an assembly will not achieve the *STC* rating. Where the absorptive material used with steel stud assemblies is in batt form, "steel stud batts," which are wide enough to fill the cavity from the web of one stud to the web of the adjacent stud, must be used.

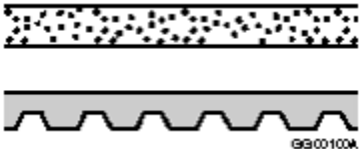
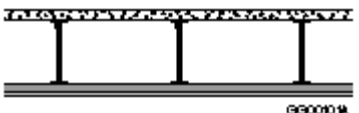
<sup>(7)</sup> The complete descriptions of indicated finishes are as follows:

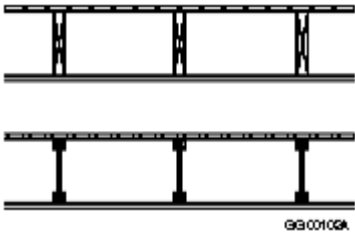
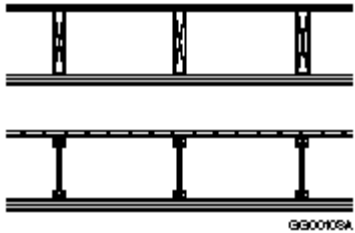
- 12.7 mm regular gypsum board – 12.7 mm regular gypsum board conforming to Article 9.29.5.2.
- 12.7 mm Type X gypsum board – 12.7 mm special fire-resistant Type X gypsum board conforming to Article 9.29.5.2.
- 15.9 mm Type X gypsum board – 15.9 mm special fire-resistant Type X gypsum board conforming to Article 9.29.5.2.
- Except for exterior walls (see Table Note (15)), the outer layer of finish on both sides of the wall must have its joints taped and finished.
- Except as otherwise required for fastener spacing (see Table Notes (14), (16) and (22)), fastener type, spacing and penetration depth for the attachment of gypsum board must conform to Subsection 9.29.5. and fasteners must consist of

- nails or screws when attaching gypsum board to wood studs or wood strapping, and
  - screws when attaching gypsum board to cold-formed steel studs or resilient metal channels.
- <sup>(8)</sup> Absorptive material required for the higher *fire-resistance rating* shall be mineral fibre processed from rock or slag with a mass per unit area of wall surface of at least 4.8 kg/m<sup>2</sup> for 150 mm thickness, 2.8 kg/m<sup>2</sup> for 89 mm thickness and 2.0 kg/m<sup>2</sup> for 65 mm thickness and shall completely fill the wall cavity. For assemblies with double wood studs on separate plates, absorptive material is required in the stud cavities on both sides.
- <sup>(9)</sup> Regular gypsum board used in single layer assemblies must be installed so all edges are supported.
- <sup>(10)</sup> The *fire-resistance rating* values are achieved as follows:
- for a single row of studs, by installing blocking at a spacing of not more than 1 524 mm o.c. as shown in Case A of Figure A-9.10.3.1.-E, or
  - for two rows of studs on separate plates, by installing blocking in both rows at a spacing of not more than 1 524 mm o.c. as shown in Case B of Figure A-9.10.3.1.-E.
- <sup>(11)</sup> The mineral fibre insulation processed from rock or slag shall have a mass per unit area of wall surface of not less than 4.48 kg/m<sup>2</sup> for 140 mm thickness and 2.85 kg/m<sup>2</sup> for 89 mm thickness and shall completely fill the wall cavity.
- <sup>(12)</sup> The dry-blown cellulose fibre insulation shall have a mass per unit area of wall surface of not less than 6.80 kg/m<sup>2</sup> for 140 mm thickness and 4.32 kg/m<sup>2</sup> for 89 mm thickness and shall completely fill the wall cavity.
- <sup>(13)</sup> Where bracing material, such as diagonal lumber or plywood, OSB, gypsum board or fibreboard sheathing is installed on the inner face of one row of studs in double stud assemblies, the *STC* rating will be reduced by 3 for any assemblies containing absorptive material in both rows of studs or in the row of studs opposite to that to which the bracing material is attached. Attaching such layers on both inner faces of the studs may drastically reduce the *STC* value but enough data to permit assignment of *STC* ratings for this situation is not available. The *fire-resistance rating* is not affected by the inclusion of such bracing.
- <sup>(14)</sup> For the attachment of the gypsum board, fasteners shall be spaced at not more than 200 mm (nominal) o.c. along the framing members and resilient metal channels in both the base and face layers.
- <sup>(15)</sup> For exterior walls, the finish joints must be taped and finished for the outer layer of the interior side only.
- <sup>(16)</sup> For the attachment of the gypsum board on the interior side of exterior wall assemblies, fasteners shall be spaced at not more than 200 mm (nominal) o.c. along the framing members. All joints shall be backed with lumber having the same dimensions as the framing members as shown in Figures A-9.10.3.1.-F and A-9.10.3.1.-G. For EW1e, EW2j and EW3k walls, blocking shall be installed at a spacing of not more than 1 524 mm o.c. as shown in Case A of Figure A-9.10.3.1.-E where joints are backed at a spacing of more than 1 524 mm o.c. along the height of the wall.
- <sup>(17)</sup> The exterior OSB or plywood sheathing shall be not less than 11.1 mm thick and shall be installed with a gap of not less than 2 mm between sheets. Fastener types and spacing shall conform to Table 9.23.3.5.-A. All joints shall be backed with lumber having the same dimensions as the framing members as shown in Figures A-9.10.3.1.-F and A-9.10.3.1.-G.
- <sup>(18)</sup> The exterior gypsum sheathing shall be Type X gypsum sheathing not less than 15.9 mm thick. Fasteners shall be spaced at not more than 200 mm (nominal) o.c. along the framing members.
- <sup>(19)</sup> Any cladding allowed under Part 9 is permitted. The cladding can include foamed plastic and other insulations outboard of the sheathing, where permitted by spatial separation requirements in Subsection 9.10.14. or 9.10.15. Where OSB or plywood sheathing acts as the cladding, no additional outboard cladding is required, but is permitted.
- <sup>(20)</sup> Includes any exterior wall sheathing listed in Table 9.23.17.2.-A and masonry veneer cladding conforming to Section 9.20. Foamed plastic sheathing is permitted in EW1e, EW2j and EW3k walls without the use of other sheathing, provided it is directly attached to the framing.
- <sup>(21)</sup> The glass fibre insulation shall have a mass per unit area of wall surface of not less than 1.30 kg/m<sup>2</sup> for 140 mm thickness and 1.0 kg/m<sup>2</sup> for 89 mm thickness and shall completely fill the wall cavity.
- <sup>(22)</sup> For the attachment of the gypsum board on the interior side of exterior wall assemblies, fasteners shall be spaced at not more than 150 mm (nominal) o.c. along the edges and 200 mm (nominal) o.c. along the intermediate supports. All joints shall be backed with lumber having the same dimensions as the framing members as shown in Figures A-9.10.3.1.-F and A-9.10.3.1.-G.
- <sup>(23)</sup> The exterior gypsum sheathing shall be not less than 12.7 mm thick. Fasteners shall be spaced at not more than 200 mm (nominal) o.c. along the framing members.

**Table 9.10.3.1.-B**

**Fire and Sound Resistance of Floors, Ceilings and Roofs(1)  
Forming Part of Article 5.8.1.3., Sentences 9.10.3.1.(1) and 9.10.5.1.(3), and  
Article 9.11.1.3.**

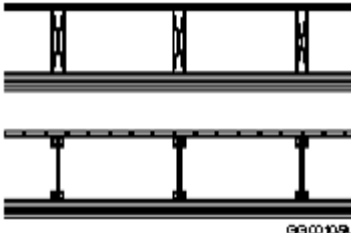
Type of Assembly	Assembly Number	Description <sup>(2)(3)(4)</sup>	Fire-Resistance Rating <sup>(5)(6)(7)(8)</sup>	Typical Sound Transmission Class <sup>(9)(6)(7)(9)(10)(11)</sup> (STC)	Typical Impact Insulation Class <sup>(9)(9)(12)</sup> (IIC)
Floors and Ceilings					
Concrete Slabs	<b>F1</b>	<ul style="list-style-type: none"> <li>concrete floors</li> </ul>			
	F1a	<ul style="list-style-type: none"> <li>90 mm reinforced concrete with 20 mm minimum cover over reinforcing steel</li> </ul>	1 h	47	23
	F1b	<ul style="list-style-type: none"> <li>130 mm reinforced concrete with 25 mm minimum cover over reinforcing steel</li> </ul>	2 h	52	27
	F1c	<ul style="list-style-type: none"> <li>pre-stressed hollow core slab 200 mm deep with 25 mm minimum cover over reinforcing steel</li> </ul>	1 h	50	28
	F1d	<ul style="list-style-type: none"> <li>150 mm composite slab on 75 mm steel deck with 152 × 152 × MW3.8 × MW3.8 wire mesh</li> </ul>	-	51	21
	F1e	<ul style="list-style-type: none"> <li>150 mm composite slab on 75 mm steel deck with 152 × 152 × MW3.8 × MW3.8 wire mesh</li> <li>resilient metal channels 400 mm or 600 mm o.c.</li> <li>2 layers of 12.7 mm Type X gypsum board or 2 layers of 15.9 mm Type X gypsum board</li> </ul>	1.5 h	57	36
Open Web Steel Joists	<b>F2</b>	<ul style="list-style-type: none"> <li>open web steel joists with concrete floor</li> </ul>			
	F2a	<ul style="list-style-type: none"> <li>50 mm thick concrete deck</li> <li>on open web steel joists spaced 400 mm o.c.</li> <li>furring channels spaced not more than 600 mm o.c. wired to underside of joists</li> <li>1 layer of 15.9 mm Type X gypsum board on ceiling side</li> </ul>	45 min	53	27
	F2b	<ul style="list-style-type: none"> <li>65 mm regular concrete minimum 155 kg/m<sup>2</sup></li> <li>on composite steel joists spaced 1250 mm o.c.</li> </ul>	1.5 h	53	28

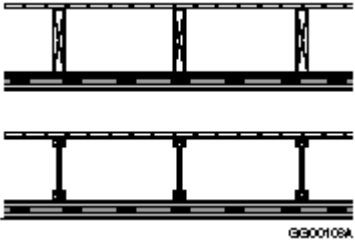
		<ul style="list-style-type: none"> <li>furring channels spaced not more than 600 mm o.c. wired to underside of joists</li> <li>1 layer of 12.7 mm or 15.9 mm Type X gypsum board on ceiling side</li> </ul>			
Wood Floor Joists <sup>(13)</sup>	<b>F3</b> <sup>(14)</sup>	<ul style="list-style-type: none"> <li>subfloor of 15.5 mm plywood, OSB or waferboard, or 17 mm tongue and groove lumber</li> <li>on wood joists or wood I-joists spaced not more than 600 mm o.c.</li> <li>with or without absorptive material in cavity</li> <li>1 layer of gypsum board on ceiling side</li> </ul>			
	F3a	F3 with <ul style="list-style-type: none"> <li>no absorptive material in cavity</li> <li>15.9 mm Type X gypsum board</li> </ul>	-	29	27
	F3b	F3 with <ul style="list-style-type: none"> <li>absorptive material in cavity</li> <li>15.9 mm Type X gypsum board</li> </ul>	-	31	30
	F3c	F3 with <ul style="list-style-type: none"> <li>no absorptive material in cavity</li> <li>12.7 mm Type X gypsum board</li> </ul>	-	27	26
	F3d	F3 with <ul style="list-style-type: none"> <li>absorptive material in cavity</li> <li>12.7 mm Type X gypsum board</li> </ul>	-	29	29
	F3e	F3 with <ul style="list-style-type: none"> <li>no absorptive material in cavity</li> <li>12.7 mm regular gypsum board</li> </ul>	-	27	25
	F3f	F3 with <ul style="list-style-type: none"> <li>absorptive material in cavity</li> <li>12.7 mm regular gypsum board</li> </ul>	-	29	28
	<b>F4</b> <sup>(14)</sup>	<ul style="list-style-type: none"> <li>subfloor of 15.5 mm plywood, OSB or waferboard, or 17 mm tongue and groove lumber</li> <li>on wood joists or wood I-joists spaced not more than 600 mm o.c.</li> <li>with or without absorptive material in cavity</li> <li>2 layers of gypsum board on ceiling side</li> </ul>			
	F4a	F4 with <ul style="list-style-type: none"> <li>wood joists or wood I-joists spaced 400 mm o.c.</li> <li>no absorptive material in cavity</li> <li>15.9 mm Type X gypsum board</li> </ul>	1 h	33	31
	F4b	F4 with <ul style="list-style-type: none"> <li>wood joists or wood I-joists spaced 600 mm o.c.</li> <li>no absorptive material in cavity</li> <li>15.9 mm Type X gypsum board</li> </ul>	1 h	34	31
	F4c	F4 with <ul style="list-style-type: none"> <li>wood joists or wood I-joists spaced 400 mm o.c.</li> </ul>	45 min [1 h] <sup>(15)</sup>	35	34

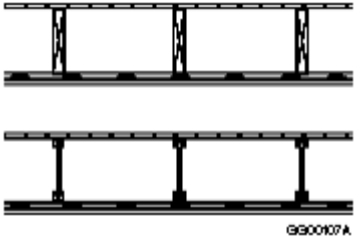
		<ul style="list-style-type: none"> <li>• absorptive material in cavity</li> <li>• 15.9 mm Type X gypsum board</li> </ul>			
	F4d	<ul style="list-style-type: none"> <li>• F4 with</li> <li>• wood joists or wood I-joists spaced 600 mm o.c.</li> <li>• absorptive material in cavity</li> <li>• 15.9 mm Type X gypsum board</li> </ul>	45 min	38	34
	F4e	<ul style="list-style-type: none"> <li>• F4 with</li> <li>• wood joists or wood I-joists spaced 400 mm o.c.</li> <li>• no absorptive material in cavity</li> <li>• 12.7 mm Type X gypsum board</li> </ul>	1 h	32	30
	F4f	<ul style="list-style-type: none"> <li>• F4 with</li> <li>• wood joists or wood I-joists spaced 400 mm o.c.</li> <li>• no absorptive material in cavity</li> <li>• 12.7 mm Type X gypsum board</li> </ul>	45 min	33	30
	F4g	<ul style="list-style-type: none"> <li>• F4 with</li> <li>• wood joists or wood I-joists spaced 400 mm o.c.</li> <li>• absorptive material in cavity</li> <li>• 12.7 mm Type X gypsum board</li> </ul>	45 min	34	33
	F4h	<ul style="list-style-type: none"> <li>• F4 with</li> <li>• wood joists or wood I-joists spaced 600 mm o.c.</li> <li>• absorptive material in cavity</li> <li>• 12.7 mm Type X gypsum board</li> </ul>	-	35	33
	F4i	<ul style="list-style-type: none"> <li>• F4 with</li> <li>• no absorptive material in cavity</li> <li>• 12.7 mm regular gypsum board</li> </ul>	-	31	30
	F4j	<ul style="list-style-type: none"> <li>• F4 with</li> <li>• absorptive material in cavity</li> <li>• 12.7 mm regular gypsum board</li> </ul>	-	33	33
	<b>F5<sup>(14)</sup></b>	<ul style="list-style-type: none"> <li>• subfloor of 15.5 mm plywood, OSB or waferboard, or 17 mm tongue and groove lumber</li> <li>• on wood joists or wood I-joists spaced not more than 600 mm o.c.</li> <li>• with or without absorptive material in cavity</li> <li>• steel furring channels spaced 400 mm or 600 mm o.c.</li> <li>• 1 layer of gypsum board on ceiling side</li> </ul>			
	F5a	<ul style="list-style-type: none"> <li>• F5 with</li> <li>• no absorptive material in cavity</li> <li>• steel furring channels spaced 400 mm o.c.</li> <li>• 15.9 mm Type X gypsum</li> </ul>	30 min	35	37
	F5b	<ul style="list-style-type: none"> <li>• F5 with</li> <li>• no absorptive material in cavity</li> <li>• steel furring channels spaced 600 mm o.c</li> <li>• 15.9 mm Type X gypsum board</li> </ul>	30 min	37	30

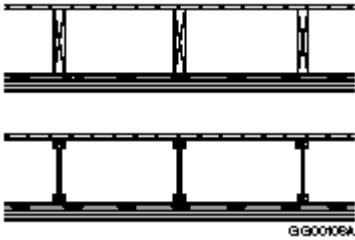


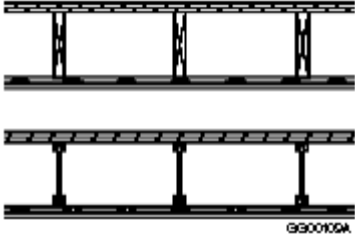
	F5c	F5 with • absorptive material in cavity • steel furring channels spaced 400 mm o.c. • 15.9 mm Type X gypsum board	30 min [45 min] <sup>(16)</sup>	38	30
	F5d	F5 with • absorptive material in cavity • steel furring channels spaced 600 mm o.c. • 15.9 mm Type X gypsum board	30 min	40	33
	F5e	F5 with • no absorptive material in cavity • steel furring channels spaced 400 mm o.c. • 12.7 mm Type X gypsum board	30 min	33	26
	F5f	F5 with • no absorptive material in cavity • steel furring channels spaced 600 mm o.c. • 12.7 mm Type X gypsum board	30 min	35	29
	F5g	F5 with • absorptive material in cavity • steel furring channels spaced 400 mm o.c. • 12.7 mm Type X gypsum board	30 min [45 min] <sup>(16)</sup>	36	29
	F5h	F5 with • absorptive material in cavity • steel furring channels spaced 600 mm o.c. • 12.7 mm Type X gypsum board	30 min	38	32
	F5i	F5 with • no absorptive material in cavity • steel furring channels spaced 400 mm o.c. • 12.7 mm regular gypsum board	<30 min	33	25
	F5j	F5 with • no absorptive material in cavity • steel furring channels spaced 600 mm o.c. • 12.7 mm regular gypsum board	<30 min	35	28
	F5k	F5 with • absorptive material in cavity • steel furring channels spaced 400 mm o.c. • 12.7 mm regular gypsum board	<30 min	36	28
	F5l	F5 with • absorptive material in cavity • steel furring channels spaced 600 mm o.c. • 12.7 mm regular gypsum board	<30 min	38	33

	<b>F6<sup>(14)</sup></b>	<ul style="list-style-type: none"> <li>• subfloor of 15.5 mm plywood, OSB or waferboard, or 17 mm tongue and groove lumber</li> <li>• on wood joists or wood I-joists spaced not more than 600 mm o.c.</li> <li>• with or without absorptive material in cavity</li> <li>• steel furring channels spaced 400 mm or 600 mm o.c.</li> <li>• 2 layers of gypsum board on ceiling side</li> </ul>			
	F6a <sup>(17)</sup>	<ul style="list-style-type: none"> <li>• F6 with</li> <li>• no absorptive material in cavity</li> <li>• steel furring channels spaced 400 mm o.c.</li> <li>• 15.9 mm Type X gypsum board</li> </ul>	1 h	39	32
	F6b <sup>(17)</sup>	<ul style="list-style-type: none"> <li>• F6 with</li> <li>• no absorptive material in cavity</li> <li>• steel furring channels spaced 600 mm o.c.</li> <li>• 15.9 mm Type X gypsum board</li> </ul>	1 h	41	32
	F6c <sup>(17)</sup>	<ul style="list-style-type: none"> <li>• F6 with</li> <li>• absorptive material in cavity</li> <li>• steel furring channels spaced 400 mm o.c.</li> <li>• 15.9 mm Type X gypsum board</li> </ul>	1 h	42	35
	F6d <sup>(17)</sup>	<ul style="list-style-type: none"> <li>• F6 with</li> <li>• absorptive material in cavity</li> <li>• steel furring channels spaced 600 mm o.c.</li> <li>• 15.9 mm Type X gypsum board</li> </ul>	1 h	44	37
	F6e <sup>(17)</sup>	<ul style="list-style-type: none"> <li>• F6 with</li> <li>• no absorptive material in cavity</li> <li>• steel furring channels spaced 400 mm o.c.</li> <li>• 12.7 mm Type X gypsum board</li> </ul>	1 h	38	30
	F6f <sup>(17)</sup>	<ul style="list-style-type: none"> <li>• F6 with</li> <li>• no absorptive material in cavity</li> <li>• steel furring channels spaced 600 mm o.c.</li> <li>• 12.7 mm Type X gypsum board</li> </ul>	1 h	40	33
	F6g <sup>(17)</sup>	<ul style="list-style-type: none"> <li>• F6 with</li> <li>• absorptive material in cavity</li> <li>• steel furring channels spaced 400 mm o.c.</li> <li>• 12.7 mm Type X gypsum board</li> </ul>	1 h	41	33
	F6h <sup>(17)</sup>	<ul style="list-style-type: none"> <li>• F6 with</li> <li>• absorptive material in cavity</li> <li>• steel furring channels spaced 600 mm o.c.</li> <li>• 12.7 mm Type X gypsum board</li> </ul>	45 min [1 h] <sup>(18)</sup>	43	36
	F6i	<ul style="list-style-type: none"> <li>• F6 with</li> <li>• no absorptive material in cavity</li> <li>• steel furring channels spaced 400 mm o.c.</li> </ul>	-	37	30

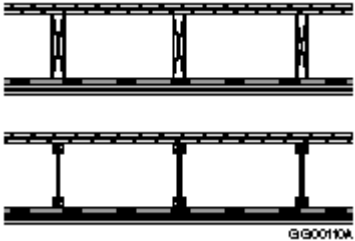
		<ul style="list-style-type: none"> <li>• 12.7 mm regular gypsum board</li> </ul>			
	F6j	<ul style="list-style-type: none"> <li>• F6 with</li> <li>• no absorptive material in cavity</li> <li>• steel furring channels spaced 600 mm o.c.</li> <li>• 12.7 mm regular gypsum board</li> </ul>	-	39	33
	F6k	<ul style="list-style-type: none"> <li>• F6 with</li> <li>• absorptive material in cavity</li> <li>• steel furring channels spaced 400 mm o.c.</li> <li>• 12.7 mm regular gypsum board</li> </ul>	-	40	33
	F6l	<ul style="list-style-type: none"> <li>• F6 with</li> <li>• absorptive material in cavity</li> <li>• steel furring channels spaced 600 mm o.c.</li> <li>• 12.7 mm regular gypsum board</li> </ul>	-	42	36
	<b>F7</b> <sup>(14)</sup>	<ul style="list-style-type: none"> <li>• subfloor of 15.5 mm plywood, OSB or waferboard, or 17 mm tongue and groove lumber</li> <li>• on wood joists or wood I-joists spaced not more than 600 mm o.c.</li> <li>• with or without absorptive material in cavity</li> <li>• 1 layer of gypsum board attached directly to joists on ceiling side</li> <li>• resilient metal channels spaced 400 mm or 600 mm o.c. attached to joists through gypsum board</li> <li>• 1 layer of gypsum board attached to resilient metal channels</li> </ul>			
	F7a <sup>(17)</sup>	<ul style="list-style-type: none"> <li>• F7 with</li> <li>• no absorptive material in cavity</li> <li>• 15.9 mm Type X gypsum board</li> <li>• resilient metal channels</li> <li>• 15.9 mm Type X gypsum board</li> </ul>	1 h	35	27
	F7b <sup>(17)</sup>	<ul style="list-style-type: none"> <li>• F7 with</li> <li>• absorptive material in cavity</li> <li>• 15.9 mm Type X gypsum board</li> <li>• resilient metal channels</li> <li>• 15.9 mm Type X gypsum board</li> </ul>	1 h	37	30
	F7c <sup>(17)</sup>	<ul style="list-style-type: none"> <li>• F7 with</li> <li>• no absorptive material in cavity</li> <li>• 12.7 mm Type X gypsum board</li> <li>• resilient metal channels</li> <li>• 12.7 mm Type X gypsum board</li> </ul>	1 h	35	27
	F7d <sup>(17)</sup>	<ul style="list-style-type: none"> <li>• F7 with</li> <li>• absorptive material in cavity</li> <li>• 12.7 mm Type X gypsum board</li> <li>• resilient metal channels</li> <li>• 12.7 mm Type X gypsum board</li> </ul>	1 h	37	30
	F7e	<ul style="list-style-type: none"> <li>• F7 with</li> <li>• no absorptive material in cavity</li> <li>• 12.7 mm regular gypsum board</li> <li>• resilient metal channels</li> </ul>	-	32	26

		<ul style="list-style-type: none"> <li>• 12.7 mm regular gypsum board</li> </ul>			
	F7f	F7 with <ul style="list-style-type: none"> <li>• absorptive material in cavity</li> <li>• 12.7 mm regular gypsum board</li> <li>• resilient metal channels</li> <li>• 12.7 mm regular gypsum board</li> </ul>	-	35	28
	<b>F8</b> <sup>(14)</sup>	<ul style="list-style-type: none"> <li>• subfloor of 15.5 mm plywood, OSB or waferboard, or 17 mm tongue and groove lumber</li> <li>• on wood joists or wood I-joists spaced not more than 600 mm o.c.</li> <li>• with or without absorptive material in cavity</li> <li>• resilient metal channels spaced 400 mm or 600 mm o.c.</li> <li>• 1 layer of gypsum board on ceiling side</li> </ul>			
	F8a	F8 with <ul style="list-style-type: none"> <li>• no absorptive material in cavity</li> <li>• resilient metal channels spaced 400 mm o.c.</li> <li>• 15.9 mm Type X gypsum board</li> </ul>	30 min	41	33
	F8b	F8 with <ul style="list-style-type: none"> <li>• no absorptive material in cavity</li> <li>• resilient metal channels spaced 600 mm o.c.</li> <li>• 15.9 mm Type X gypsum board</li> </ul>	30 min	43	36
	F8c	F8 with <ul style="list-style-type: none"> <li>• absorptive material in cavity</li> <li>• resilient metal channels spaced 400 mm o.c.</li> <li>• 15.9 mm Type X gypsum board</li> </ul>	30 min [45 min] <sup>(16)</sup>	48	41
	F8d	F8 with <ul style="list-style-type: none"> <li>• absorptive material in cavity</li> <li>• resilient metal channels spaced 600 mm o.c.</li> <li>• 15.9 mm Type X gypsum board</li> </ul>	30 min	50	44
	F8e	F8 with <ul style="list-style-type: none"> <li>• no absorptive material in cavity</li> <li>• resilient metal channels spaced 400 mm o.c.</li> <li>• 12.7 mm Type X gypsum board</li> </ul>	30 min	39	32
	F8f	F8 with <ul style="list-style-type: none"> <li>• no absorptive material in cavity</li> <li>• resilient metal channels spaced 600 mm o.c.</li> <li>• 12.7 mm Type X gypsum board</li> </ul>	30 min	41	35
	F8g	F8 with <ul style="list-style-type: none"> <li>• absorptive material in cavity</li> <li>• resilient metal channels spaced 400 mm o.c.</li> <li>• 12.7 mm Type X gypsum board</li> </ul>	30 min [45 min] <sup>(16)</sup>	46	40
	F8h	F8 with <ul style="list-style-type: none"> <li>• absorptive material in cavity</li> </ul>	30 min	48	43

		<ul style="list-style-type: none"> <li>• resilient metal channels spaced 600 mm o.c.</li> <li>• 12.7 mm Type X gypsum board</li> </ul>			
	F8i	<ul style="list-style-type: none"> <li>• F8 with</li> <li>• no absorptive material in cavity</li> <li>• resilient metal channels spaced 400 mm o.c.</li> <li>• 12.7 mm regular gypsum board</li> </ul>	< 30 min	41	31
	F8j	<ul style="list-style-type: none"> <li>• F8 with</li> <li>• no absorptive material in cavity</li> <li>• resilient metal channels spaced 600 mm o.c.</li> <li>• 12.7 mm regular gypsum board</li> </ul>	< 30 min	41	34
	F8k	<ul style="list-style-type: none"> <li>• F8 with</li> <li>• absorptive material in cavity</li> <li>• resilient metal channels spaced 400 mm o.c.</li> <li>• 12.7 mm regular gypsum board</li> </ul>	< 30 min	46	39
	F8l	<ul style="list-style-type: none"> <li>• F8 with</li> <li>• absorptive material in cavity</li> <li>• resilient metal channels spaced 600 mm o.c.</li> <li>• 12.7 mm regular gypsum board</li> </ul>	< 30 min	48	42
	<b>F9<sup>(14)</sup></b>	<ul style="list-style-type: none"> <li>• subfloor of 15.5 mm plywood, OSB or waferboard, or 17 mm tongue and groove lumber</li> <li>• on wood joists or wood I-joists spaced not more than 600 mm o.c.</li> <li>• with or without absorptive material in cavity</li> <li>• resilient metal channels spaced 400 mm or 600 mm o.c.</li> <li>• 2 layers of gypsum board on ceiling side</li> </ul>			
	F9a <sup>(17)</sup>	<ul style="list-style-type: none"> <li>• F9 with</li> <li>• no absorptive material in cavity</li> <li>• resilient metal channels spaced 400 mm o.c.</li> <li>• 15.9 mm Type X gypsum board</li> </ul>	1 h	45	38
	F9b <sup>(17)</sup>	<ul style="list-style-type: none"> <li>• F9 with</li> <li>• no absorptive material in cavity</li> <li>• resilient metal channels spaced 600 mm o.c.</li> <li>• 15.9 mm Type X gypsum board</li> </ul>	1 h	47	40
	F9c <sup>(17)</sup>	<ul style="list-style-type: none"> <li>• F9 with</li> <li>• absorptive material in cavity</li> <li>• resilient metal channels spaced 400 mm o.c.</li> <li>• 15.9 mm Type X gypsum board</li> </ul>	1 h [1.5 h] <sup>(19)</sup>	52 [54] <sup>(19)</sup>	46
	F9d <sup>(17)</sup>	<ul style="list-style-type: none"> <li>• F9 with</li> <li>• absorptive material in cavity</li> <li>• resilient metal channels spaced 600 mm o.c.</li> <li>• 15.9 mm Type X gypsum board</li> </ul>	1 h [1.5 h] <sup>(19)</sup>	54 [56] <sup>(19)</sup>	48

	F9e <sup>(17)</sup>	F9 with <ul style="list-style-type: none"> <li>• no absorptive material in cavity</li> <li>• resilient metal channels spaced 400 mm o.c.</li> <li>• 12.7 mm Type X gypsum board</li> </ul>	1 h	44	36
	F9f <sup>(17)</sup>	F9 with <ul style="list-style-type: none"> <li>• no absorptive material in cavity</li> <li>• resilient metal channels spaced 600 mm o.c.</li> <li>• 12.7 mm Type X gypsum board</li> </ul>	1 h	46	39
	F9g <sup>(17)</sup>	F9 with <ul style="list-style-type: none"> <li>• absorptive material in cavity</li> <li>• resilient metal channels spaced 400 mm o.c.</li> <li>• 12.7 mm Type X gypsum board</li> </ul>	1 h [1.5 h] <sup>(19)</sup>	51 [53] <sup>(19)</sup>	44
	F9h <sup>(17)</sup>	F9 with <ul style="list-style-type: none"> <li>• absorptive material in cavity</li> <li>• resilient metal channels spaced 600 mm o.c.</li> <li>• 12.7 mm Type X gypsum board</li> </ul>	45 min [1 h] <sup>(18)</sup>	53	47
	F9i	F9 with <ul style="list-style-type: none"> <li>• no absorptive material in cavity</li> <li>• resilient metal channels spaced 400 mm o.c.</li> <li>• 12.7 mm regular gypsum board</li> </ul>	-	43	36
	F9j	F9 with <ul style="list-style-type: none"> <li>• no absorptive material in cavity</li> <li>• resilient metal channels spaced 600 mm o.c.</li> <li>• 12.7 mm regular gypsum board</li> </ul>	-	45	39
	F9k	F9 with <ul style="list-style-type: none"> <li>• absorptive material in cavity</li> <li>• resilient metal channels spaced 400 mm o.c.</li> <li>• 12.7 mm regular gypsum board</li> </ul>	-	50	44
	F9l	F9 with <ul style="list-style-type: none"> <li>• absorptive material in cavity</li> <li>• resilient metal channels spaced 600 mm o.c.</li> <li>• 12.7 mm regular gypsum board</li> </ul>	-	52	47
	<b>F10<sup>(14)</sup></b>	<ul style="list-style-type: none"> <li>• one subfloor layer of 11 mm sanded plywood, or OSB or waferboard</li> <li>• one subfloor layer of 15.5 mm plywood, OSB or waferboard, or 17 mm tongue and groove lumber</li> <li>• on wood joists or wood I-joists spaced not more than 600 mm o.c.</li> <li>• with or without absorptive material in cavity</li> <li>• resilient metal channels spaced 300, 400 or 600 mm o.c.</li> <li>• 1 layer of gypsum board on ceiling side</li> </ul>			
	F10a	F10 with <ul style="list-style-type: none"> <li>• no absorptive material in cavity</li> </ul>	30 min	44	34

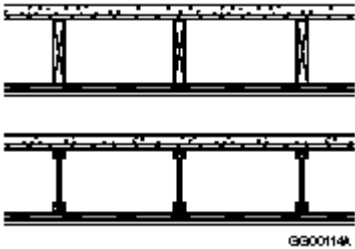
		<ul style="list-style-type: none"> <li>• resilient metal channels spaced 400 mm o.c.</li> <li>• 15.9 mm Type X gypsum board</li> </ul>			
	F10b	<ul style="list-style-type: none"> <li>• F10 with</li> <li>• no absorptive material in cavity</li> <li>• resilient metal channels spaced 600 mm o.c.</li> <li>• 15.9 mm Type X gypsum board</li> </ul>	30 min	46	37
	F10c	<ul style="list-style-type: none"> <li>• F10 with</li> <li>• absorptive material in cavity</li> <li>• resilient metal channels spaced 400 mm o.c.</li> <li>• 15.9 mm Type X gypsum board</li> </ul>	30 min [45 min] <sup>(18)</sup>	51	42
	F10d	<ul style="list-style-type: none"> <li>• F10 with</li> <li>• absorptive material in cavity</li> <li>• resilient metal channels spaced 600 mm o.c.</li> <li>• 15.9 mm Type X gypsum board</li> </ul>	30 min [45 min] <sup>(16)</sup>	53	45
	F10e	<ul style="list-style-type: none"> <li>• F10 with</li> <li>• wood joists spaced at 400 mm o.c.</li> <li>• absorptive material in cavity</li> <li>• resilient metal channels spaced 400 mm o.c.</li> <li>• 15.9 mm Type X gypsum board</li> </ul>	1 h <sup>(20)</sup>	53 <sup>(20)</sup>	44
	F10f <sup>(21)</sup>	<ul style="list-style-type: none"> <li>• F10 with</li> <li>• wood I-joists spaced at 400 mm o.c.</li> <li>• absorptive material in cavity</li> <li>• resilient metal channels spaced 300 mm o.c.</li> <li>• 15.9 mm Type X gypsum board</li> </ul>	1 h <sup>(20)</sup>	52 <sup>(20)</sup>	43
	F10g	<ul style="list-style-type: none"> <li>• F10 with</li> <li>• no absorptive material in cavity</li> <li>• resilient metal channels spaced 400 mm o.c.</li> <li>• 12.7 mm Type X gypsum board</li> </ul>	30 min	42	33
	F10h	<ul style="list-style-type: none"> <li>• F10 with</li> <li>• no absorptive material in cavity</li> <li>• resilient metal channels spaced 600 mm o.c.</li> <li>• 12.7 mm Type X gypsum board</li> </ul>	30 min	44	36
	F10i	<ul style="list-style-type: none"> <li>• F10 with</li> <li>• absorptive material in cavity</li> <li>• resilient metal channels spaced 400 mm o.c.</li> <li>• 12.7 mm Type X gypsum board</li> </ul>	30 min [45 min] <sup>(18)</sup>	49	41
	F10j	<ul style="list-style-type: none"> <li>• F10 with</li> <li>• absorptive material in cavity</li> <li>• resilient metal channels spaced 600 mm o.c.</li> <li>• 12.7 mm Type X gypsum board</li> </ul>	30 min [45 min] <sup>(16)</sup>	51	44
	F10k	<ul style="list-style-type: none"> <li>• F10 with</li> <li>• no absorptive material in cavity</li> </ul>	-	42	33

		<ul style="list-style-type: none"> <li>resilient metal channels spaced 400 mm o.c.</li> <li>12.7 mm regular gypsum board</li> </ul>			
	F10l	<ul style="list-style-type: none"> <li>F10 with</li> <li>no absorptive material in cavity</li> <li>resilient metal channels spaced 600 mm o.c.</li> <li>12.7 mm regular gypsum board</li> </ul>	-	44	35
	F10m	<ul style="list-style-type: none"> <li>F10 with</li> <li>absorptive material in cavity</li> <li>resilient metal channels spaced 400 mm o.c.</li> <li>12.7 mm regular gypsum board</li> </ul>	-	49	41
	F10n	<ul style="list-style-type: none"> <li>F10 with</li> <li>absorptive material in cavity</li> <li>resilient metal channels spaced 600 mm o.c.</li> <li>12.7 mm regular gypsum board</li> </ul>	-	51	43
	<b>F11</b> <sup>(14)</sup>	<ul style="list-style-type: none"> <li>one subfloor layer of 11 mm sanded plywood, or OSB or waferboard</li> <li>one subfloor layer of 15.5 mm plywood, OSB or waferboard, or 17 mm tongue and groove lumber</li> <li>on wood joists or wood I-joists spaced not more than 600 mm o.c.</li> <li>with or without absorptive material in cavity</li> <li>resilient metal channels spaced 400 mm or 600 mm o.c.</li> <li>2 layers of gypsum board on ceiling side</li> </ul>			
	F11a <sup>(17)</sup>	<ul style="list-style-type: none"> <li>F11 with</li> <li>no absorptive material in cavity</li> <li>resilient metal channels spaced 400 mm o.c.</li> <li>15.9 mm Type X gypsum board</li> </ul>	1 h	48	39
	F11b <sup>(17)</sup>	<ul style="list-style-type: none"> <li>F11 with</li> <li>no absorptive material in cavity</li> <li>resilient metal channels spaced 600 mm o.c.</li> <li>15.9 mm Type X gypsum board</li> </ul>	1 h	50	42
	F11c <sup>(17)</sup>	<ul style="list-style-type: none"> <li>F11 with</li> <li>absorptive material in cavity</li> <li>resilient metal channels spaced 400 mm o.c.</li> <li>15.9 mm Type X gypsum board</li> </ul>	1 h [1.5 h] <sup>(19)</sup>	55 [56] <sup>(19)</sup>	47
	F11d <sup>(17)</sup>	<ul style="list-style-type: none"> <li>F11 with</li> <li>absorptive material in cavity</li> <li>resilient metal channels spaced 600 mm o.c.</li> <li>15.9 mm Type X gypsum board</li> </ul>	1 h [1.5 h] <sup>(19)</sup>	57 [58] <sup>(19)</sup>	50
	F11e <sup>(17)</sup>	<ul style="list-style-type: none"> <li>F11 with</li> <li>wood joists spaced 400 mm o.c.</li> <li>absorptive material in cavity</li> </ul>	1.5 h <sup>(22)</sup>	56 <sup>(22)</sup>	47

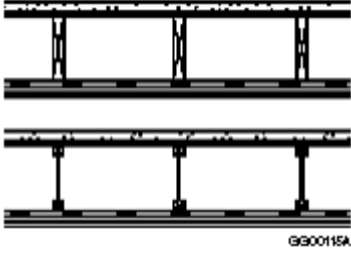


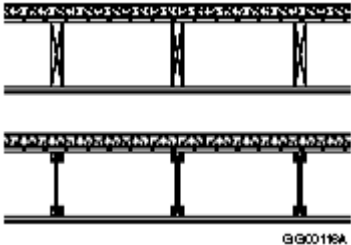
		<ul style="list-style-type: none"> <li>• resilient metal channels spaced 400 mm o.c.</li> <li>• 15.9 mm Type X gypsum board</li> </ul>			
	F11f <sup>(21)</sup>	<ul style="list-style-type: none"> <li>• F11 with</li> <li>• wood I-joists spaced 400 mm o.c.</li> <li>• absorptive material in cavity</li> <li>• resilient metal channels spaced 300 mm o.c.</li> <li>• 15.9 mm Type X gypsum board</li> </ul>	1.5 h <sup>(22)</sup>	56 <sup>(22)</sup>	46
	F11g <sup>(17)</sup>	<ul style="list-style-type: none"> <li>• F11 with</li> <li>• no absorptive material in cavity</li> <li>• resilient metal channels spaced 400 mm o.c.</li> <li>• 12.7 mm Type X gypsum board</li> </ul>	1 h	47	38
	F11h <sup>(17)</sup>	<ul style="list-style-type: none"> <li>• F11 with</li> <li>• no absorptive material in cavity</li> <li>• resilient metal channels spaced 600 mm o.c.</li> <li>• 12.7 mm Type X gypsum board</li> </ul>	1 h	49	40
	F11i <sup>(17)</sup>	<ul style="list-style-type: none"> <li>• F11 with</li> <li>• absorptive material in cavity</li> <li>• resilient metal channels spaced 400 mm o.c.</li> <li>• 12.7 mm Type X gypsum board</li> </ul>	1 h [1.5 h] <sup>(19)</sup>	54 [55] <sup>(19)</sup>	46
	F11j <sup>(17)</sup>	<ul style="list-style-type: none"> <li>• F11 with</li> <li>• absorptive material in cavity</li> <li>• resilient metal channels spaced 600 mm o.c.</li> <li>• 12.7 mm Type X gypsum board</li> </ul>	45 min [1 h] <sup>(18)</sup>	56	48
	F11k	<ul style="list-style-type: none"> <li>• F11 with</li> <li>• no absorptive material in cavity</li> <li>• resilient metal channels spaced 400 mm o.c.</li> <li>• 12.7 mm regular gypsum board</li> </ul>	-	46	37
	F11l	<ul style="list-style-type: none"> <li>• F11 with</li> <li>• no absorptive material in cavity</li> <li>• resilient metal channels spaced 600 mm o.c.</li> <li>• 12.7 mm regular gypsum board</li> </ul>	-	48	40
	F11m	<ul style="list-style-type: none"> <li>• F11 with</li> <li>• absorptive material in cavity</li> <li>• resilient metal channels spaced 400 mm o.c.</li> <li>• 12.7 mm regular gypsum board</li> </ul>	-	53	45
	F11n	<ul style="list-style-type: none"> <li>• F11 with</li> <li>• absorptive material in cavity</li> <li>• resilient metal channels spaced 600 mm o.c.</li> <li>• 12.7 mm regular gypsum board</li> </ul>	-	55	48

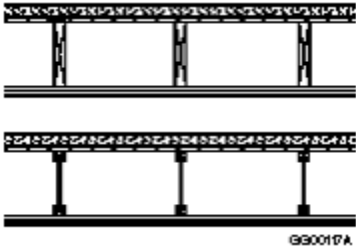
	<b>F12<sup>(14)</sup></b>	<ul style="list-style-type: none"> <li>• 25 mm gypsum-concrete topping (at least 44 kg/m<sup>2</sup>)</li> <li>• subfloor of 15.5 mm plywood, OSB or waferboard, or 17 mm tongue and groove lumber</li> <li>• on wood joists or wood I-joists spaced not more than 600 mm o.c.</li> <li>• with or without absorptive material in cavity</li> <li>• 1 layer of gypsum board on ceiling side</li> </ul>			
	F12a	<ul style="list-style-type: none"> <li>• F12 with</li> <li>• no absorptive material in cavity</li> <li>• 15.9 mm Type X gypsum board</li> </ul>	-	41	13
	F12b	<ul style="list-style-type: none"> <li>• F12 with</li> <li>• absorptive material in cavity</li> <li>• 15.9 mm Type X gypsum board</li> </ul>	-	43	16
	F12c	<ul style="list-style-type: none"> <li>• F12 with</li> <li>• no absorptive material in cavity</li> <li>• 12.7 mm Type X gypsum board</li> </ul>	-	39	12
	F12d	<ul style="list-style-type: none"> <li>• F12 with</li> <li>• absorptive material in cavity</li> <li>• 12.7 mm Type X gypsum board</li> </ul>	-	41	15
	F12e	<ul style="list-style-type: none"> <li>• F12 with</li> <li>• no absorptive material in cavity</li> <li>• 12.7 mm regular gypsum board</li> </ul>	-	39	12
	F12f	<ul style="list-style-type: none"> <li>• F12 with</li> <li>• absorptive material in cavity</li> <li>• 12.7 mm regular gypsum board</li> </ul>	-	41	15
	<b>F13<sup>(14)</sup></b>	<ul style="list-style-type: none"> <li>• 25 mm gypsum-concrete topping (at least 44 kg/m<sup>2</sup>)</li> <li>• subfloor of 15.5 mm plywood, OSB or waferboard, or 17 mm tongue and groove lumber</li> <li>• on wood joists or wood I-joists spaced not more than 600 mm o.c.</li> <li>• with or without absorptive material in cavity</li> <li>• 2 layers of gypsum board on ceiling side</li> </ul>			
	F13a	<ul style="list-style-type: none"> <li>• F13 with</li> <li>• wood joists or wood I-joists spaced 400 mm o.c.</li> <li>• no absorptive material in cavity</li> <li>• 15.9 mm Type X gypsum board</li> </ul>	1 h	43	16
	F13b	<ul style="list-style-type: none"> <li>• F13 with</li> <li>• wood joists or wood I-joists spaced 600 mm o.c.</li> <li>• no absorptive material in cavity</li> <li>• 15.9 mm Type X gypsum board</li> </ul>	1 h	45	16
	F13c	<ul style="list-style-type: none"> <li>• F13 with</li> <li>• wood joists or wood I-joists spaced 400 mm o.c.</li> <li>• absorptive material in cavity</li> <li>• 15.9 mm Type X gypsum board</li> </ul>	45 min [1 h] <sup>(15)</sup>	45	19

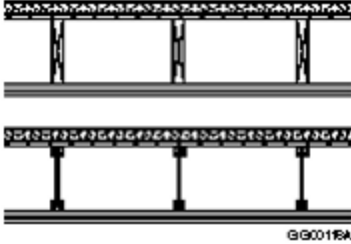
	F13d	F13 with <ul style="list-style-type: none"> <li>• wood joists or wood I-joists spaced 600 mm o.c.</li> <li>• absorptive material in cavity</li> <li>• 15.9 mm Type X gypsum board</li> </ul>	45 min	47	19
	F13e	F13 with <ul style="list-style-type: none"> <li>• wood joists or wood I-joists spaced 400 mm o.c.</li> <li>• no absorptive material in cavity</li> <li>• 12.7 mm Type X gypsum board</li> </ul>	1 h	42	15
	F13f	F13 with <ul style="list-style-type: none"> <li>• wood joists or wood I-joists spaced 600 mm o.c.</li> <li>• no absorptive material in cavity</li> <li>• 12.7 mm Type X gypsum board</li> </ul>	45 min	44	15
	F13g	F13 with <ul style="list-style-type: none"> <li>• wood joists or wood I-joists spaced 400 mm o.c.</li> <li>• absorptive material in cavity</li> <li>• 12.7 mm Type X gypsum board</li> </ul>	45 min	44	18
	F13h	F13 with <ul style="list-style-type: none"> <li>• wood joists or wood I-joists spaced 600 mm o.c.</li> <li>• no absorptive material in cavity</li> <li>• 12.7 mm Type X gypsum board</li> </ul>	-	46	18
	F13i	F13 with <ul style="list-style-type: none"> <li>• no absorptive material in cavity</li> <li>• 12.7 mm regular gypsum board</li> </ul>	-	41	14
	F13j	F13 with <ul style="list-style-type: none"> <li>• absorptive material in cavity</li> <li>• 12.7 mm regular gypsum board</li> </ul>	-	45	14
	<b>F14<sup>(14)</sup></b>	<ul style="list-style-type: none"> <li>• 25 mm gypsum-concrete topping (at least 44 kg/m<sup>2</sup>)</li> <li>• subfloor of 15.5 mm plywood, OSB or waferboard, or 17 mm tongue and groove lumber</li> <li>• on wood joists or wood I-joists spaced not more than 600 mm o.c.</li> <li>• with or without absorptive material in cavity</li> <li>• resilient metal channels spaced 300, 400 or 600 mm o.c.</li> <li>• 1 layer of gypsum board on ceiling side</li> </ul>			
	F14a	F14 with <ul style="list-style-type: none"> <li>• no absorptive material in cavity</li> <li>• resilient metal channels spaced 400 mm o.c.</li> <li>• 15.9 mm Type X gypsum board</li> </ul>	-	53	22
	F14b	F14 with <ul style="list-style-type: none"> <li>• no absorptive material in cavity</li> <li>• resilient metal channels spaced 600 mm o.c.</li> <li>• 15.9 mm Type X gypsum board</li> </ul>	-	55	22

	F14c	F14 with • absorptive material in cavity • resilient metal channels spaced 400 mm o.c. • 15.9 mm Type X gypsum board	30 min [45 min] <sup>(18)</sup>	60	30
	F14d	F14 with • absorptive material in cavity • resilient metal channels spaced 600 mm o.c. • 15.9 mm Type X gypsum board	-	62	30
	F14e	F14 with • wood joists spaced 400 mm o.c. • absorptive material in cavity • resilient metal channels spaced 400 mm o.c. • 15.9 mm Type X gypsum board	1 h <sup>(20)</sup>	60 <sup>(20)</sup>	31
	F14f <sup>(21)</sup>	F14 with • wood I-joists spaced 400 mm o.c. • absorptive material in cavity • resilient metal channels spaced 300 mm o.c. • 15.9 mm Type X gypsum board	1 h <sup>(20)</sup>	61 <sup>(20)</sup>	31
	F14g	F14 with • no absorptive material in cavity • resilient metal channels spaced 400 mm o.c. • 12.7 mm Type X gypsum board	-	51	21
	F14h	F14 with • no absorptive material in cavity • resilient metal channels spaced 600 mm o.c. • 12.7 mm Type X gypsum board	-	53	21
	F14i	F14 with • absorptive material in cavity • resilient metal channels spaced 400 mm o.c. • 12.7 mm Type X gypsum board	-	58	29
	F14j	F14 with • absorptive material in cavity • resilient metal channels spaced 600 mm o.c. • 12.7 mm Type X gypsum board	-	60	29
	F14k	F14 with • no absorptive material in cavity • resilient metal channels spaced 400 mm o.c. • 12.7 mm regular gypsum board	-	51	21
	F14l	F14 with • no absorptive material in cavity • resilient metal channels spaced 600 mm o.c. • 12.7 mm regular gypsum board	-	53	21
	F14m	F14 with	-	58	29

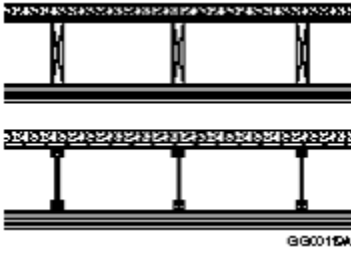
		<ul style="list-style-type: none"> <li>• absorptive material in cavity</li> <li>• resilient metal channels spaced 400 mm o.c.</li> <li>• 12.7 mm regular gypsum board</li> </ul>			
	F14n	<ul style="list-style-type: none"> <li>• F14 with</li> <li>• absorptive material in cavity</li> <li>• resilient metal channels spaced 600 mm o.c.</li> <li>• 12.7 mm regular gypsum board</li> </ul>	-	60	29
	<b>F15<sup>(14)</sup></b>	<ul style="list-style-type: none"> <li>• 25 mm gypsum-concrete topping (at least 44 kg/m<sup>2</sup>)</li> <li>• subfloor of 15.5 mm plywood, OSB or waferboard, or 17 mm tongue and groove lumber</li> <li>• on wood joists or wood I-joists spaced not more than 600 mm o.c.</li> <li>• with or without absorptive material in cavity</li> <li>• resilient metal channels spaced 400 mm or 600 mm o.c.</li> <li>• 2 layers of gypsum board on ceiling side</li> </ul>			
	F15a <sup>(17)</sup>	<ul style="list-style-type: none"> <li>• F15 with</li> <li>• no absorptive material in cavity</li> <li>• resilient metal channels spaced 400 mm o.c.</li> <li>• 15.9 mm Type X gypsum board</li> </ul>	1 h <sup>(23)</sup>	57	25
	F15b <sup>(17)</sup>	<ul style="list-style-type: none"> <li>• F15 with</li> <li>• no absorptive material in cavity</li> <li>• resilient metal channels spaced 600 mm o.c.</li> <li>• 15.9 mm Type X gypsum board</li> </ul>	1 h	59	25
	F15c <sup>(17)</sup>	<ul style="list-style-type: none"> <li>• F15 with</li> <li>• absorptive material in cavity</li> <li>• resilient metal channels spaced 400 mm o.c.</li> <li>• 15.9 mm Type X gypsum board</li> </ul>	1 h [1.5 h] <sup>(19)</sup>	64 [65] <sup>(19)</sup>	33
	F15d <sup>(17)</sup>	<ul style="list-style-type: none"> <li>• F15 with</li> <li>• absorptive material in cavity</li> <li>• resilient metal channels spaced 600 mm o.c.</li> <li>• 15.9 mm Type X gypsum board</li> </ul>	1 h [1.5 h] <sup>(19)</sup>	66 [67] <sup>(19)</sup>	33
	F15e <sup>(17)</sup>	<ul style="list-style-type: none"> <li>• F15 with</li> <li>• wood joists spaced 400 mm o.c.</li> <li>• absorptive material in cavity</li> <li>• resilient metal channels spaced 400 mm o.c.</li> <li>• 15.9 mm Type X gypsum board</li> </ul>	1.5 h <sup>(22)</sup>	65 <sup>(22)</sup>	33
	F15f <sup>(21)</sup>	<ul style="list-style-type: none"> <li>• F15 with</li> <li>• wood I-joists spaced 400 mm o.c.</li> <li>• absorptive material in cavity</li> <li>• resilient metal channels spaced 300 mm o.c.</li> <li>• 15.9 mm Type X gypsum board</li> </ul>	1.5 h <sup>(22)</sup>	64 <sup>(22)</sup>	33
	F15g <sup>(17)</sup>	F15 with	1 h	56	24

		<ul style="list-style-type: none"> <li>• no absorptive material in cavity</li> <li>• resilient metal channels spaced 400 mm o.c.</li> <li>• 12.7 mm Type X gypsum board</li> </ul>			
	F15h <sup>(17)</sup>	<ul style="list-style-type: none"> <li>• F15 with</li> <li>• no absorptive material in cavity</li> <li>• resilient metal channels spaced 600 mm o.c.</li> <li>• 12.7 mm Type X gypsum board</li> </ul>	1 h	58	24
	F15i <sup>(17)</sup>	<ul style="list-style-type: none"> <li>• F15 with</li> <li>• absorptive material in cavity</li> <li>• resilient metal channels spaced 400 mm o.c.</li> <li>• 12.7 mm Type X gypsum board</li> </ul>	1 h [1.5 h] <sup>(19)</sup>	63 [64] <sup>(19)</sup>	32
	F15j <sup>(17)</sup>	<ul style="list-style-type: none"> <li>• F15 with</li> <li>• absorptive material in cavity</li> <li>• resilient metal channels spaced 600 mm o.c.</li> <li>• 12.7 mm Type X gypsum board</li> </ul>	45 min [1 h] <sup>(18)</sup>	65	32
	F15k	<ul style="list-style-type: none"> <li>• F15 with</li> <li>• no absorptive material in cavity</li> <li>• resilient metal channels spaced 400 mm o.c.</li> <li>• 12.7 mm regular gypsum board</li> </ul>	-	55	23
	F15l	<ul style="list-style-type: none"> <li>• F15 with</li> <li>• no absorptive material in cavity</li> <li>• resilient metal channels spaced 600 mm o.c.</li> <li>• 12.7 mm regular gypsum board</li> </ul>	-	57	23
	F15m	<ul style="list-style-type: none"> <li>• F15 with</li> <li>• absorptive material in cavity</li> <li>• resilient metal channels spaced 400 mm o.c.</li> <li>• 12.7 mm regular gypsum board</li> </ul>	-	62	31
	F15n	<ul style="list-style-type: none"> <li>• F15 with</li> <li>• absorptive material in cavity</li> <li>• resilient metal channels spaced 600 mm o.c.</li> <li>• 12.7 mm regular gypsum board</li> </ul>	-	64	31
	<b>F16<sup>(14)</sup></b>	<ul style="list-style-type: none"> <li>• 38 mm concrete topping (at least 70 kg/m<sup>2</sup>)</li> <li>• subfloor of 15.5 mm plywood, OSB or waferboard, or 17 mm tongue and groove lumber</li> <li>• on wood joists or wood I-joists spaced not more than 600 mm o.c.</li> <li>• with or without absorptive material in cavity</li> <li>• 1 layer of gypsum board on ceiling side</li> </ul>			
	F16a	<ul style="list-style-type: none"> <li>• F 16 with</li> <li>• no absorptive material in cavity</li> <li>• 15.9 mm Type X gypsum board</li> </ul>	-	44	22
	F16b	F16 with	-	46	25

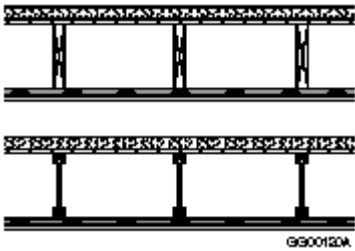
		<ul style="list-style-type: none"> <li>• absorptive material in cavity</li> <li>• 15.9 mm Type X gypsum board</li> </ul>			
	F16c	<ul style="list-style-type: none"> <li>• F16 with</li> <li>• no absorptive material in cavity</li> <li>• 12.7 mm Type X gypsum board</li> </ul>	-	43	21
	F16d	<ul style="list-style-type: none"> <li>• F16 with</li> <li>• absorptive material in cavity</li> <li>• 12.7 mm Type X gypsum board</li> </ul>	-	45	24
	F16e	<ul style="list-style-type: none"> <li>• F16 with</li> <li>• no absorptive material in cavity</li> <li>• 12.7 mm regular gypsum board</li> </ul>	-	42	21
	F16f	<ul style="list-style-type: none"> <li>• F16 with</li> <li>• absorptive material in cavity</li> <li>• 12.7 mm regular gypsum board</li> </ul>	-	44	24
	<b>F17<sup>(14)</sup></b>	<ul style="list-style-type: none"> <li>• 38 mm concrete topping (at least 70 kg/m<sup>2</sup>)</li> <li>• subfloor of 15.5 mm plywood, OSB or waferboard, or 17 mm tongue and groove lumber</li> <li>• on wood joists or wood I-joists spaced not more than 600 mm o.c.</li> <li>• with or without absorptive material in cavity</li> <li>• 2 layers of gypsum board on ceiling side</li> </ul>	 <p style="text-align: right; font-size: small;">G90017A</p>		
	F17a	<ul style="list-style-type: none"> <li>• F17 with</li> <li>• wood joists or wood I-joists spaced 400 mm o.c.</li> <li>• no absorptive material in cavity</li> <li>• 15.9 mm Type X gypsum board</li> </ul>	1 h	48	24
	F17b	<ul style="list-style-type: none"> <li>• F17 with</li> <li>• wood joists or wood I-joists spaced 600 mm o.c.</li> <li>• no absorptive material in cavity</li> <li>• 15.9 mm Type X gypsum board</li> </ul>	1 h	51	24
	F17c	<ul style="list-style-type: none"> <li>• F17 with</li> <li>• wood joists or wood I-joists spaced 400 mm o.c.</li> <li>• absorptive material in cavity</li> <li>• 15.9 mm Type X gypsum board</li> </ul>	45 min [1 h] <sup>(15)</sup>	48	27
	F17d	<ul style="list-style-type: none"> <li>• F17 with</li> <li>• wood joists or wood I-joists spaced 600 mm o.c.</li> <li>• absorptive material in cavity</li> <li>• 15.9 mm Type X gypsum board</li> </ul>	45 min	51	27
	F17e	<ul style="list-style-type: none"> <li>• F17 with</li> <li>• wood joists or wood I-joists spaced 400 mm o.c.</li> <li>• no absorptive material in cavity</li> <li>• 12.7 mm Type X gypsum board</li> </ul>	1 h	47	23
	F17f	<ul style="list-style-type: none"> <li>• F17 with</li> <li>• wood joists or wood I-joists spaced 600 mm o.c.</li> </ul>	45 min	48	23

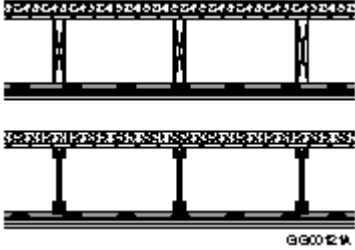
		<ul style="list-style-type: none"> <li>• no absorptive material in cavity</li> <li>• 12.7 mm Type X gypsum board</li> </ul>			
	F17g	<ul style="list-style-type: none"> <li>• F17 with</li> <li>• wood joists or wood I-joists spaced 400 mm o.c.</li> <li>• absorptive material in cavity</li> <li>• 12.7 mm Type X gypsum board</li> </ul>	45 min	49	26
	F17h	<ul style="list-style-type: none"> <li>• F17 with</li> <li>• wood joists or wood I-joists spaced 600 mm o.c.</li> <li>• absorptive material in cavity</li> <li>• 12.7 mm Type X gypsum board</li> </ul>	-	50	26
	F17i	<ul style="list-style-type: none"> <li>• F17 with</li> <li>• no absorptive material in cavity</li> <li>• 12.7 mm regular gypsum board</li> </ul>	-	47	23
	F17j	<ul style="list-style-type: none"> <li>• F17 with</li> <li>• absorptive material in cavity</li> <li>• 12.7 mm regular gypsum board</li> </ul>	-	49	26
	<b>F18<sup>(14)</sup></b>	<ul style="list-style-type: none"> <li>• 38 mm concrete topping (at least 70 kg/m<sup>2</sup>)</li> <li>• subfloor of 15.5 mm plywood, OSB or waferboard, or 17 mm tongue and groove lumber</li> <li>• on wood joists or wood I-joists spaced not more than 600 mm o.c.</li> <li>• with or without absorptive material in cavity</li> <li>• steel furring channels spaced 400 mm or 600 mm o.c.</li> <li>• 1 layer of gypsum board on ceiling side</li> </ul>	 <p>The diagram shows a cross-section of a ceiling assembly. From top to bottom, it consists of: a concrete topping on a steel joist; a subfloor (plywood, OSB, or waferboard) on top of the joist; a layer of gypsum board on the ceiling side of the joist; and a steel furring channel on the ceiling side of the joist. The joists are spaced at 400 mm or 600 mm o.c. The diagram is labeled 'GG0018A'.</p>		
	F18a	<ul style="list-style-type: none"> <li>• F18 with</li> <li>• no absorptive material in cavity</li> <li>• steel furring channels spaced 400 mm o.c.</li> <li>• 15.9 mm Type X gypsum board</li> </ul>	-	50	25
	F18b	<ul style="list-style-type: none"> <li>• F18 with</li> <li>• no absorptive material in cavity</li> <li>• steel furring channels spaced 600 mm o.c.</li> <li>• 15.9 mm Type X gypsum board</li> </ul>	-	52	25
	F18c	<ul style="list-style-type: none"> <li>• F18 with</li> <li>• absorptive material in cavity</li> <li>• steel furring channels spaced 400 mm o.c.</li> <li>• 15.9 mm Type X gypsum board</li> </ul>	-	53	28
	F18d	<ul style="list-style-type: none"> <li>• F18 with</li> <li>• absorptive material in cavity</li> <li>• steel furring channels spaced 600 mm o.c.</li> <li>• 15.9 mm Type X gypsum board</li> </ul>	-	55	28
	F18e	<ul style="list-style-type: none"> <li>• F18 with</li> <li>• no absorptive material in cavity</li> </ul>	-	49	24



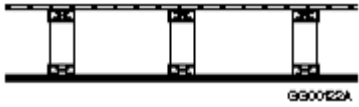
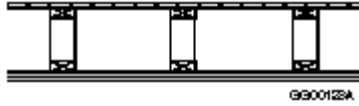
		<ul style="list-style-type: none"> <li>• steel furring channels spaced 400 mm o.c.</li> <li>• 12.7 mm Type X gypsum board</li> </ul>			
	F18f	<ul style="list-style-type: none"> <li>• F18 with</li> <li>• no absorptive material in cavity</li> <li>• steel furring channels spaced 600 mm o.c.</li> <li>• 12.7 mm Type X gypsum board</li> </ul>	-	51	24
	F18g	<ul style="list-style-type: none"> <li>• F18 with</li> <li>• absorptive material in cavity</li> <li>• steel furring channels spaced 400 mm o.c.</li> <li>• 12.7 mm Type X gypsum board</li> </ul>	-	52	27
	F18h	<ul style="list-style-type: none"> <li>• F18 with</li> <li>• absorptive material in cavity</li> <li>• steel furring channels spaced 600 mm o.c.</li> <li>• 12.7 mm Type X gypsum board</li> </ul>	-	54	27
	F18i	<ul style="list-style-type: none"> <li>• F18 with</li> <li>• no absorptive material in cavity</li> <li>• steel furring channels spaced 400 mm o.c.</li> <li>• 12.7 mm regular gypsum board</li> </ul>	-	48	24
	F18j	<ul style="list-style-type: none"> <li>• F18 with</li> <li>• no absorptive material in cavity</li> <li>• steel furring channels spaced 600 mm o.c.</li> <li>• 12.7 mm regular gypsum board</li> </ul>	-	50	24
	F18k	<ul style="list-style-type: none"> <li>• F18 with</li> <li>• absorptive material in cavity</li> <li>• steel furring channels spaced 400 mm o.c.</li> <li>• 12.7 mm regular gypsum board</li> </ul>	-	51	27
	F18l	<ul style="list-style-type: none"> <li>• F18 with</li> <li>• absorptive material in cavity</li> <li>• steel furring channels spaced 600 mm o.c.</li> <li>• 12.7 mm regular gypsum board</li> </ul>	-	53	27
	<b>F19<sup>(14)</sup></b>	<ul style="list-style-type: none"> <li>• 38 mm concrete topping (at least 70 kg/m<sup>2</sup>)</li> <li>• subfloor of 15.5 mm plywood, OSB or waferboard, or 17 mm tongue and groove lumber</li> <li>• on wood joists or wood I-joists spaced not more than 600 mm o.c.</li> <li>• with or without absorptive material in cavity</li> <li>• steel furring channels spaced 400 mm or 600 mm o.c.</li> <li>• 2 layers of gypsum board on ceiling side</li> </ul>			
	F19a <sup>(17)</sup>	<ul style="list-style-type: none"> <li>• F19 with</li> <li>• no absorptive material in cavity</li> <li>• steel furring channels spaced 400 mm o.c.</li> </ul>	1 h	54	27

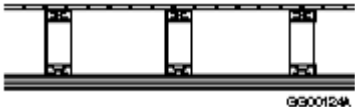
		• 15.9 mm Type X gypsum board			
	F19b <sup>(17)</sup>	F19 with • no absorptive material in cavity • steel furring channels spaced 600 mm o.c. • 15.9 mm Type X gypsum board	1 h	56	27
	F19c <sup>(17)</sup>	F19 with • absorptive material in cavity • steel furring channels spaced 400 mm o.c. • 15.9 mm Type X gypsum board	1 h	57	30
	F19d <sup>(17)</sup>	F19 with • absorptive material in cavity • steel furring channels spaced 600 mm o.c. • 15.9 mm Type X gypsum board	1 h	59	30
	F19e <sup>(17)</sup>	F19 with • no absorptive material in cavity • steel furring channels spaced 400 mm o.c. • 12.7 mm Type X gypsum board	1 h	53	26
	F19f <sup>(17)</sup>	F19 with • no absorptive material in cavity • steel furring channels spaced 600 mm o.c. • 12.7 mm Type X gypsum board	1 h	55	26
	F19g <sup>(17)</sup>	F19 with • absorptive material in cavity • steel furring channels spaced 400 mm o.c. • 12.7 mm Type X gypsum board	1 h	56	29
	F19h <sup>(17)</sup>	F19 with • absorptive material in cavity • steel furring channels spaced 600 mm o.c. • 12.7 mm Type X gypsum board	1 h	58	29
	F19i	F19 with • no absorptive material in cavity • steel furring channels spaced 400 mm o.c. • 12.7 mm regular gypsum board	-	53	26
	F19j	F19 with • no absorptive material in cavity • steel furring channels spaced 600 mm o.c. • 12.7 mm regular gypsum board	-	55	26
	F19k	F19 with • absorptive material in cavity • steel furring channels spaced 400 mm o.c. • 12.7 mm regular gypsum board	-	56	29
	F19l	F19 with	-	58	29

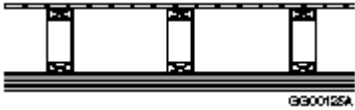
		<ul style="list-style-type: none"> <li>• absorptive material in cavity</li> <li>• steel furring channels spaced 600 mm o.c.</li> <li>• 12.7 mm regular gypsum board</li> </ul>			
	<b>F20<sup>(14)</sup></b>	<ul style="list-style-type: none"> <li>• 38 mm concrete topping (at least 70 kg/m<sup>2</sup>)</li> <li>• subfloor of 15.5 mm plywood, OSB or waferboard, or 17 mm tongue and groove lumber</li> <li>• on wood joists or wood I-joists spaced not more than 600 mm o.c.</li> <li>• with or without absorptive material in cavity</li> <li>• resilient metal channels spaced 300, 400 or 600 mm o.c.</li> <li>• 1 layer of gypsum board on ceiling side</li> </ul>			
	F20a	<ul style="list-style-type: none"> <li>• F20 with</li> <li>• no absorptive material in cavity</li> <li>• resilient metal channels spaced 400 mm o.c.</li> <li>• 15.9 mm Type X gypsum board</li> </ul>	45 min <sup>(23)</sup>	56	31
	F20b	<ul style="list-style-type: none"> <li>• F20 with</li> <li>• no absorptive material in cavity</li> <li>• resilient metal channels spaced 600 mm o.c.</li> <li>• 15.9 mm Type X gypsum board</li> </ul>	-	58	31
	F20c	<ul style="list-style-type: none"> <li>• F20 with</li> <li>• absorptive material in cavity</li> <li>• resilient metal channels spaced 400 mm o.c.</li> <li>• 15.9 mm Type X gypsum board</li> </ul>	30 min [45 min] <sup>(18)(23)</sup>	63	39
	F20d	<ul style="list-style-type: none"> <li>• F20 with</li> <li>• absorptive material in cavity</li> <li>• resilient metal channels spaced 600 mm o.c.</li> <li>• 15.9 mm Type X gypsum board</li> </ul>	-	65	39
	F20e	<ul style="list-style-type: none"> <li>• F20 with</li> <li>• wood joists spaced 400 mm o.c.</li> <li>• absorptive material in cavity</li> <li>• resilient metal channels spaced 400 mm o.c.</li> <li>• 15.9 mm Type X gypsum board</li> </ul>	1 h <sup>(20)</sup>	64 <sup>(20)</sup>	40
	F20f <sup>(21)</sup>	<ul style="list-style-type: none"> <li>• F20 with</li> <li>• wood I-joists spaced 400 mm o.c.</li> <li>• absorptive material in cavity</li> <li>• resilient metal channels spaced 300 mm o.c.</li> <li>• 15.9 mm Type X gypsum board</li> </ul>	1 h <sup>(20)</sup>	65 <sup>(20)</sup>	40
	F20g	<ul style="list-style-type: none"> <li>• F20 with</li> <li>• no absorptive material in cavity</li> <li>• resilient metal channels spaced 400 mm o.c.</li> <li>• 12.7 mm Type X gypsum board</li> </ul>	-	55	30
	F20h	F20 with	-	57	30

		<ul style="list-style-type: none"> <li>• no absorptive material in cavity</li> <li>• resilient metal channels spaced 600 mm o.c.</li> <li>• 12.7 mm Type X gypsum board</li> </ul>			
	F20i	<ul style="list-style-type: none"> <li>• F20 with</li> <li>• absorptive material in cavity</li> <li>• resilient metal channels spaced 400 mm o.c.</li> <li>• 12.7 mm Type X gypsum board</li> </ul>	-	62	38
	F20j	<ul style="list-style-type: none"> <li>• F20 with</li> <li>• absorptive material in cavity</li> <li>• resilient metal channels spaced 600 mm o.c.</li> <li>• 12.7 mm Type X gypsum board</li> </ul>	-	64	38
	F20k	<ul style="list-style-type: none"> <li>• F20 with</li> <li>• no absorptive material in cavity</li> <li>• resilient metal channels spaced 400 mm o.c.</li> <li>• 12.7 mm regular gypsum board</li> </ul>	-	54	30
	F20l	<ul style="list-style-type: none"> <li>• F20 with</li> <li>• no absorptive material in cavity</li> <li>• resilient metal channels spaced 600 mm o.c.</li> <li>• 12.7 mm regular gypsum board</li> </ul>	-	56	30
	F20m	<ul style="list-style-type: none"> <li>• F20 with</li> <li>• absorptive material in cavity</li> <li>• resilient metal channels spaced 400 mm o.c.</li> <li>• 12.7 mm regular gypsum board</li> </ul>	-	61	38
	F20n	<ul style="list-style-type: none"> <li>• F20 with</li> <li>• absorptive material in cavity</li> <li>• resilient metal channels spaced 600 mm o.c.</li> <li>• 12.7 mm regular gypsum board</li> </ul>	-	63	38
	<b>F21<sup>(14)</sup></b>	<ul style="list-style-type: none"> <li>• 38 mm concrete topping (at least 70 kg/m<sup>2</sup>)</li> <li>• subfloor of 15.5 mm plywood, OSB or waferboard, or 17 mm tongue and groove lumber</li> <li>• on wood joists or wood I-joists spaced not more than 600 mm o.c.</li> <li>• with or without absorptive material in cavity</li> <li>• resilient metal channels spaced 400 mm or 600 mm o.c.</li> <li>• 2 layers of gypsum board on ceiling side</li> </ul>			
	F21a <sup>(17)</sup>	<ul style="list-style-type: none"> <li>• F21 with</li> <li>• no absorptive material in cavity</li> <li>• resilient metal channels spaced 400 mm o.c.</li> <li>• 15.9 mm Type X gypsum board</li> </ul>	1 h	60	33
	F21b <sup>(17)</sup>	<ul style="list-style-type: none"> <li>• F21 with</li> <li>• no absorptive material in cavity</li> </ul>	1 h	62	33

		<ul style="list-style-type: none"> <li>• resilient metal channels spaced 600 mm o.c.</li> <li>• 15.9 mm Type X gypsum board</li> </ul>			
	F21c <sup>(17)</sup>	F21 with <ul style="list-style-type: none"> <li>• absorptive material in cavity</li> <li>• resilient metal channels spaced 400 mm o.c.</li> <li>• 15.9 mm Type X gypsum board</li> </ul>	1 h [1.5 h] <sup>(19)</sup>	67 [68] <sup>(19)</sup>	41 [42] <sup>(19)</sup>
	F21d <sup>(17)</sup>	F21 with <ul style="list-style-type: none"> <li>• absorptive material in cavity</li> <li>• resilient metal channels spaced 400 mm o.c.</li> <li>• 15.9 mm Type X gypsum board</li> </ul>	1 h [1.5 h] <sup>(19)</sup>	69 [70] <sup>(19)</sup>	41 [42] <sup>(19)</sup>
	F21e <sup>(17)</sup>	F21 with <ul style="list-style-type: none"> <li>• wood joists spaced 400 mm o.c.</li> <li>• absorptive material in cavity</li> <li>• resilient metal channels spaced 400 mm o.c.</li> <li>• 15.9 mm Type X gypsum board</li> </ul>	[1.5 h] <sup>(22)</sup>	68 <sup>(22)</sup>	42
	F21f <sup>(21)</sup>	F21 with <ul style="list-style-type: none"> <li>• wood I-joists spaced 400 mm o.c.</li> <li>• absorptive material in cavity</li> <li>• resilient metal channels spaced 300 mm o.c.</li> <li>• 15.9 mm Type X gypsum board</li> </ul>	[1.5 h] <sup>(22)</sup>	68 <sup>(22)</sup>	42
	F21g <sup>(17)</sup>	F21 with <ul style="list-style-type: none"> <li>• no absorptive material in cavity</li> <li>• resilient metal channels spaced 400 mm o.c.</li> <li>• 12.7 mm Type X gypsum board</li> </ul>	1 h	59	32
	F21h <sup>(17)</sup>	F21 with <ul style="list-style-type: none"> <li>• no absorptive material in cavity</li> <li>• resilient metal channels spaced 600 mm o.c.</li> <li>• 12.7 mm Type X gypsum board</li> </ul>	1 h	61	32
	F21i <sup>(17)</sup>	F21 with <ul style="list-style-type: none"> <li>• absorptive material in cavity</li> <li>• resilient metal channels spaced 400 mm o.c.</li> <li>• 12.7 mm Type X gypsum board</li> </ul>	1 h [1.5 h] <sup>(19)</sup>	66 [67] <sup>(19)</sup>	40
	F21j <sup>(17)</sup>	F21 with <ul style="list-style-type: none"> <li>• absorptive material in cavity</li> <li>• resilient metal channels spaced 600 mm o.c.</li> <li>• 12.7 mm Type X gypsum board</li> </ul>	1 h	68	40
	F21k	F21 with <ul style="list-style-type: none"> <li>• no absorptive material in cavity</li> <li>• resilient metal channels spaced 400 mm o.c.</li> <li>• 12.7 mm regular gypsum board</li> </ul>	-	59	32
	F21l	F21 with <ul style="list-style-type: none"> <li>• no absorptive material in cavity</li> </ul>	-	61	32

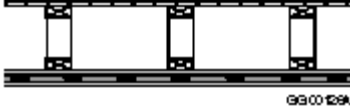
		<ul style="list-style-type: none"> <li>resilient metal channels spaced 600 mm o.c.</li> <li>12.7 mm regular gypsum board</li> </ul>			
	F21m	F21 with <ul style="list-style-type: none"> <li>absorptive material in cavity</li> <li>resilient metal channels spaced 400 mm o.c.</li> <li>12.7 mm regular gypsum board</li> </ul>	-	66	40
	F21n	F21 with <ul style="list-style-type: none"> <li>absorptive material in cavity</li> <li>resilient metal channels spaced 600 mm o.c.</li> <li>12.7 mm regular gypsum board</li> </ul>	-	68	40
Wood Floor Trusses <sup>(24)</sup>	<b>F22</b>	<ul style="list-style-type: none"> <li>subfloor of 15.5 mm plywood, OSB or waferboard, or 17 mm tongue and groove lumber</li> <li>on wood trusses spaced not more than 600 mm o.c.</li> <li>with or without absorptive material in cavity</li> <li>1 layer gypsum board on ceiling side</li> </ul>			
	F22a	F22 with <ul style="list-style-type: none"> <li>no absorptive material in cavity</li> <li>15.9 mm Type X gypsum board</li> </ul>	-	29	27
	F22b	F22 with <ul style="list-style-type: none"> <li>absorptive material in cavity</li> <li>15.9 mm Type X gypsum board</li> </ul>	-	31	30
	F22c	F22 with <ul style="list-style-type: none"> <li>no absorptive material in cavity</li> <li>12.7 mm Type X gypsum board</li> </ul>	-	28	26
	F22d	F22 with <ul style="list-style-type: none"> <li>absorptive material in cavity</li> <li>12.7 mm Type X gypsum board</li> </ul>	-	30	29
	F22e	F22 with <ul style="list-style-type: none"> <li>no absorptive material in cavity</li> <li>12.7 mm regular gypsum board</li> </ul>	-	27	25
	F22f	F22 with <ul style="list-style-type: none"> <li>absorptive material in cavity</li> <li>12.7 mm regular gypsum board</li> </ul>	-	31	28
	<b>F23</b>	<ul style="list-style-type: none"> <li>subfloor of 15.5 mm plywood, OSB or waferboard, or 17 mm tongue and groove lumber</li> <li>on wood trusses spaced not more than 600 mm o.c.</li> <li>with or without absorptive material in cavity</li> <li>2 layers of gypsum board on ceiling side</li> </ul>			
	F23a	F23 with <ul style="list-style-type: none"> <li>wood trusses spaced 400 mm o.c.</li> <li>no absorptive material in cavity</li> <li>15.9 mm Type X gypsum board</li> </ul>	1 h	34	31


	F23b	F23 with <ul style="list-style-type: none"> <li>• wood trusses spaced 600 mm o.c.</li> <li>• no absorptive material in cavity</li> <li>• 15.9 mm Type X gypsum board</li> </ul>	1 h	35	31
	F23c	F23 with <ul style="list-style-type: none"> <li>• wood trusses spaced 400 mm o.c.</li> <li>• absorptive material in cavity</li> <li>• 15.9 mm Type X gypsum board</li> </ul>	45 min [1 h] <sup>(15)</sup>	36	34
	F23d	F23 with <ul style="list-style-type: none"> <li>• wood trusses spaced 600 mm o.c.</li> <li>• absorptive material in cavity</li> <li>• 15.9 mm Type X gypsum board</li> </ul>	45 min	37	34
	F23e	F23 with <ul style="list-style-type: none"> <li>• wood trusses spaced 400 mm o.c.</li> <li>• no absorptive material in cavity</li> <li>• 12.7 mm Type X gypsum board</li> </ul>	1 h	32	30
	F23f	F23 with <ul style="list-style-type: none"> <li>• wood trusses spaced 600 mm o.c.</li> <li>• no absorptive material in cavity</li> <li>• 12.7 mm Type X gypsum board</li> </ul>	45 min	33	30
	F23g	F23 with <ul style="list-style-type: none"> <li>• absorptive material in cavity</li> <li>• 12.7 mm Type X gypsum board</li> </ul>	-	34	33
	F23h	F23 with <ul style="list-style-type: none"> <li>• no absorptive material in cavity</li> <li>• 12.7 mm regular gypsum board</li> </ul>	-	32	30
	F23i	F23 with <ul style="list-style-type: none"> <li>• absorptive material in cavity</li> <li>• 12.7 mm regular gypsum board</li> </ul>	-	34	33
	<b>F24</b>	<ul style="list-style-type: none"> <li>• subfloor of 15.5 mm plywood, OSB or waferboard, or 17 mm tongue and groove lumber</li> <li>• on wood trusses spaced not more than 600 mm o.c.</li> <li>• with or without absorptive material in cavity</li> <li>• steel furring channels spaced 400 mm or 600 mm o.c.</li> <li>• 1 layer of gypsum board on ceiling side</li> </ul>			
	F24a	F24 with <ul style="list-style-type: none"> <li>• no absorptive material in cavity</li> <li>• steel furring channels spaced 400 mm o.c.</li> <li>• 15.9 mm Type X gypsum board</li> </ul>	-	35	27
	F24b	F24 with <ul style="list-style-type: none"> <li>• no absorptive material in cavity</li> <li>• steel furring channels spaced 600 mm o.c.</li> <li>• 15.9 mm Type X gypsum board</li> </ul>	-	37	30
	F24c	F24 with <ul style="list-style-type: none"> <li>• absorptive material in cavity</li> </ul>	-	38	30

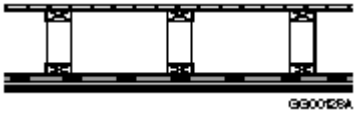
		<ul style="list-style-type: none"> <li>• steel furring channels spaced 400 mm o.c.</li> <li>• 15.9 mm Type X gypsum board</li> </ul>			
	F24d	<ul style="list-style-type: none"> <li>• F24 with absorptive material in cavity</li> <li>• steel furring channels spaced 600 mm o.c.</li> <li>• 15.9 mm Type X gypsum board</li> </ul>	-	40	33
	F24e	<ul style="list-style-type: none"> <li>• F24 with no absorptive material in cavity</li> <li>• steel furring channels spaced 400 mm o.c.</li> <li>• 12.7 mm Type X gypsum board</li> </ul>	-	33	26
	F24f	<ul style="list-style-type: none"> <li>• F24 with no absorptive material in cavity</li> <li>• steel furring channels spaced 600 mm o.c.</li> <li>• 12.7 mm Type X gypsum board</li> </ul>	-	36	29
	F24g	<ul style="list-style-type: none"> <li>• F24 with absorptive material in cavity</li> <li>• steel furring channels spaced 400 mm o.c.</li> <li>• 12.7 mm Type X gypsum board</li> </ul>	-	37	29
	F24h	<ul style="list-style-type: none"> <li>• F24 with absorptive material in cavity</li> <li>• steel furring channels spaced 600 mm o.c.</li> <li>• 12.7 mm Type X gypsum board</li> </ul>	-	39	32
	F24i	<ul style="list-style-type: none"> <li>• F24 with no absorptive material in cavity</li> <li>• steel furring channels spaced 400 mm o.c.</li> <li>• 12.7 mm regular gypsum board</li> </ul>	-	33	25
	F24j	<ul style="list-style-type: none"> <li>• F24 with no absorptive material in cavity</li> <li>• steel furring channels spaced 600 mm o.c.</li> <li>• 12.7 mm regular gypsum board</li> </ul>	-	35	28
	F24k	<ul style="list-style-type: none"> <li>• F24 with absorptive material in cavity</li> <li>• steel furring channels spaced 400 mm o.c.</li> <li>• 12.7 mm regular gypsum board</li> </ul>	-	36	28
	F24l	<ul style="list-style-type: none"> <li>• F24 with absorptive material in cavity</li> <li>• steel furring channels spaced 600 mm o.c.</li> <li>• 12.7 mm regular gypsum board</li> </ul>	-	38	31
	<b>F25</b>	<ul style="list-style-type: none"> <li>• subfloor of 15.5 mm plywood, OSB or waferboard, or 17 mm tongue and groove lumber</li> <li>• on wood trusses spaced not more than 600 mm o.c.</li> </ul>			




		<ul style="list-style-type: none"> <li>• with or without absorptive material in cavity</li> <li>• steel furring channels spaced 400 mm or 600 mm o.c.</li> <li>• 2 layers of gypsum board on ceiling side</li> </ul>			
	F25a	<ul style="list-style-type: none"> <li>• F25 with</li> <li>• no absorptive material in cavity</li> <li>• steel furring channels spaced 400 mm o.c.</li> <li>• 15.9 mm Type X gypsum board</li> </ul>	1 h	40	32
	F25b	<ul style="list-style-type: none"> <li>• F25 with</li> <li>• no absorptive material in cavity</li> <li>• steel furring channels spaced 600 mm o.c.</li> <li>• 15.9 mm Type X gypsum board</li> </ul>	1 h	42	34
	F25c	<ul style="list-style-type: none"> <li>• F25 with</li> <li>• absorptive material in cavity</li> <li>• steel furring channels spaced 400 mm o.c.</li> <li>• 15.9 mm Type X gypsum board</li> </ul>	1 h	43	35
	F25d	<ul style="list-style-type: none"> <li>• F25 with</li> <li>• absorptive material in cavity</li> <li>• steel furring channels spaced 600 mm o.c.</li> <li>• 15.9 mm Type X gypsum board</li> </ul>	45 min [1 h] <sup>(18)</sup>	45	37
	F25e	<ul style="list-style-type: none"> <li>• F25 with</li> <li>• no absorptive material in cavity</li> <li>• steel furring channels spaced 400 mm o.c.</li> <li>• 12.7 mm Type X gypsum board</li> </ul>	1 h	38	30
	F25f	<ul style="list-style-type: none"> <li>• F25 with</li> <li>• no absorptive material in cavity</li> <li>• steel furring channels spaced 600 mm o.c.</li> <li>• 12.7 mm Type X gypsum board</li> </ul>	1 h	40	33
	F25g	<ul style="list-style-type: none"> <li>• F25 with</li> <li>• absorptive material in cavity</li> <li>• steel furring channels spaced 400 mm o.c.</li> <li>• 12.7 mm Type X gypsum board</li> </ul>	1 h	41	33
	F25h	<ul style="list-style-type: none"> <li>• F25 with</li> <li>• absorptive material in cavity</li> <li>• steel furring channels spaced 600 mm o.c.</li> <li>• 12.7 mm Type X gypsum board</li> </ul>	45 min [1 h] <sup>(18)</sup>	43	36
	F25i	<ul style="list-style-type: none"> <li>• F25 with</li> <li>• no absorptive material in cavity</li> <li>• steel furring channels spaced 400 mm o.c.</li> <li>• 12.7 mm regular gypsum board</li> </ul>	-	38	30
	F25j	<ul style="list-style-type: none"> <li>• F25 with</li> <li>• no absorptive material in cavity</li> </ul>	-	40	33


		<ul style="list-style-type: none"> <li>• steel furring channels spaced 600 mm o.c.</li> <li>• 12.7 mm regular gypsum board</li> </ul>			
	F25k	<ul style="list-style-type: none"> <li>• F25 with absorptive material in cavity</li> <li>• steel furring channels spaced 400 mm o.c.</li> <li>• 12.7 mm regular gypsum board</li> </ul>	-	41	33
	F25l	<ul style="list-style-type: none"> <li>• F25 with absorptive material in cavity</li> <li>• steel furring channels spaced 600 mm o.c.</li> <li>• 12.7 mm regular gypsum board</li> </ul>	-	43	36
	<b>F26</b>	<ul style="list-style-type: none"> <li>• subfloor of 15.5 mm plywood, OSB or waferboard, or 17 mm tongue and groove lumber</li> <li>• on wood trusses spaced not more than 600 mm o.c.</li> <li>• with or without absorptive material in cavity</li> <li>• 1 layer of gypsum board attached directly to trusses on ceiling side</li> <li>• resilient metal channels spaced 400 mm or 600 mm o.c. attached to trusses through the gypsum board</li> <li>• 1 layer of gypsum board attached to resilient metal channels</li> </ul>			
	F26a	<ul style="list-style-type: none"> <li>• F26 with no absorptive material in cavity</li> <li>• 15.9 mm Type X gypsum board</li> <li>• resilient metal channels</li> <li>• 15.9 mm Type X gypsum board</li> </ul>	-	35	27
	F26b	<ul style="list-style-type: none"> <li>• F26 with absorptive material in cavity</li> <li>• 15.9 mm Type X gypsum board</li> <li>• resilient metal channels</li> <li>• 15.9 mm Type X gypsum board</li> </ul>	-	37	30
	F26c	<ul style="list-style-type: none"> <li>• F26 with no absorptive material in cavity</li> <li>• 12.7 mm Type X gypsum board</li> <li>• resilient metal channels</li> <li>• 12.7 mm Type X gypsum board</li> </ul>	-	35	27
	F26d	<ul style="list-style-type: none"> <li>• F26 with absorptive material in cavity</li> <li>• 12.7 mm Type X gypsum board</li> <li>• resilient metal channels</li> <li>• 12.7 mm Type X gypsum board</li> </ul>	-	37	30
	F26e	<ul style="list-style-type: none"> <li>• F26 with no absorptive material in cavity</li> <li>• 12.7 mm regular gypsum board</li> <li>• resilient metal channels</li> <li>• 12.7 mm regular gypsum board</li> </ul>	-	32	26
	F26f	<ul style="list-style-type: none"> <li>• F26 with absorptive material in cavity</li> </ul>	-	35	28

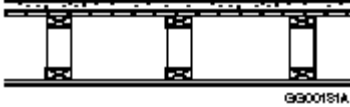
		<ul style="list-style-type: none"> <li>• 12.7 mm regular gypsum board</li> <li>• resilient metal channels</li> <li>• 12.7 mm regular gypsum board</li> </ul>			
	<b>F27</b>	<ul style="list-style-type: none"> <li>• subfloor of 15.5 mm plywood, OSB or waferboard, or 17 mm tongue and groove lumber</li> <li>• on wood trusses spaced not more than 600 mm o.c.</li> <li>• with or without absorptive material in cavity</li> <li>• resilient metal channels spaced 400 mm or 600 mm o.c.</li> <li>• 1 layer of gypsum board on ceiling side</li> </ul>			
	F27a	F27 with <ul style="list-style-type: none"> <li>• no absorptive material in cavity</li> <li>• resilient metal channels spaced 400 mm o.c.</li> <li>• 15.9 mm Type X gypsum board</li> </ul>	-	41	33
	F27b	F27 with <ul style="list-style-type: none"> <li>• no absorptive material in cavity</li> <li>• resilient metal channels spaced 600 mm o.c.</li> <li>• 15.9 mm Type X gypsum board</li> </ul>	-	43	36
	F27c	F27 with <ul style="list-style-type: none"> <li>• absorptive material in cavity</li> <li>• resilient metal channels spaced 400 mm o.c.</li> <li>• 15.9 mm Type X gypsum board</li> </ul>	30 min [45 min] <sup>(25)</sup>	48	41
	F27d	F27 with <ul style="list-style-type: none"> <li>• absorptive material in cavity</li> <li>• resilient metal channels spaced 600 mm o.c.</li> <li>• 15.9 mm Type X gypsum board</li> </ul>	-	50	44
	F27e	F27 with <ul style="list-style-type: none"> <li>• no absorptive material in cavity</li> <li>• resilient metal channels spaced 400 mm o.c.</li> <li>• 12.7 mm Type X gypsum board</li> </ul>	-	40	32
	F27f	F27 with <ul style="list-style-type: none"> <li>• no absorptive material in cavity</li> <li>• resilient metal channels spaced 600 mm o.c.</li> <li>• 12.7 mm Type X gypsum board</li> </ul>	-	42	35
	F27g	F27 with <ul style="list-style-type: none"> <li>• absorptive material in cavity</li> <li>• resilient metal channels spaced 400 mm o.c.</li> <li>• 12.7 mm Type X gypsum board</li> </ul>	-	47	40
	F27h	F27 with <ul style="list-style-type: none"> <li>• absorptive material in cavity</li> <li>• resilient metal channels spaced 600 mm o.c.</li> <li>• 12.7 mm Type X gypsum board</li> </ul>	-	49	43

	F27i	<ul style="list-style-type: none"> <li>F27 with</li> <li>• no absorptive material in cavity</li> <li>• resilient metal channels spaced 400 mm o.c.</li> <li>• 12.7 mm regular gypsum board</li> </ul>	-	39	31
	F27j	<ul style="list-style-type: none"> <li>F27 with</li> <li>• no absorptive material in cavity</li> <li>• resilient metal channels spaced 600 mm o.c.</li> <li>• 12.7 mm regular gypsum board</li> </ul>	-	41	34
	F27k	<ul style="list-style-type: none"> <li>F27 with</li> <li>• absorptive material in cavity</li> <li>• resilient metal channels spaced 400 mm o.c.</li> <li>• 12.7 mm regular gypsum board</li> </ul>	-	46	39
	F27l	<ul style="list-style-type: none"> <li>F27 with</li> <li>• absorptive material in cavity</li> <li>• resilient metal channels spaced 600 mm o.c.</li> <li>• 12.7 mm regular gypsum board</li> </ul>	-	48	42
	<b>F28</b>	<ul style="list-style-type: none"> <li>• subfloor of 15.5 mm plywood, OSB or waferboard, or 17 mm tongue and groove lumber</li> <li>• on wood trusses spaced not more than 600 mm o.c.</li> <li>• with or without absorptive material in cavity</li> <li>• resilient metal channels spaced 400 mm or 600 mm o.c.</li> <li>• 2 layers of gypsum board on ceiling side</li> </ul>			
	F28a	<ul style="list-style-type: none"> <li>F28 with</li> <li>• no absorptive material in cavity</li> <li>• resilient metal channels spaced 400 mm o.c.</li> <li>• 15.9 mm Type X gypsum board</li> </ul>	1 h	46	38
	F28b	<ul style="list-style-type: none"> <li>F28 with</li> <li>• no absorptive material in cavity</li> <li>• resilient metal channels spaced 600 mm o.c.</li> <li>• 15.9 mm Type X gypsum board</li> </ul>	1 h	48	40
	F28c	<ul style="list-style-type: none"> <li>F28 with</li> <li>• absorptive material in cavity</li> <li>• resilient metal channels spaced 400 mm o.c.</li> <li>• 15.9 mm Type X gypsum board</li> </ul>	1 h	54	46
	F28d	<ul style="list-style-type: none"> <li>F28 with</li> <li>• absorptive material in cavity</li> <li>• resilient metal channels spaced 600 mm o.c.</li> <li>• 15.9 mm Type X gypsum board</li> </ul>	45 min [1 h] <sup>(18)</sup>	55	48
	F28e	<ul style="list-style-type: none"> <li>F28 with</li> <li>• no absorptive material in cavity</li> <li>• resilient metal channels spaced 400 mm o.c.</li> </ul>	1 h	44	36

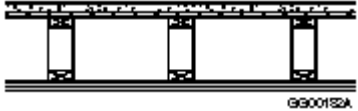

		<ul style="list-style-type: none"> <li>• 12.7 mm Type X gypsum board</li> </ul>			
	F28f	F28 with <ul style="list-style-type: none"> <li>• no absorptive material in cavity</li> <li>• resilient metal channels spaced 600 mm o.c.</li> <li>• 12.7 mm Type X gypsum board</li> </ul>	1 h	46	39
	F28g	F28 with <ul style="list-style-type: none"> <li>• absorptive material in cavity</li> <li>• resilient metal channels spaced 400 mm o.c.</li> <li>• 12.7 mm Type X gypsum board</li> </ul>	1 h	51	44
	F28h	F28 with <ul style="list-style-type: none"> <li>• absorptive material in cavity</li> <li>• resilient metal channels spaced 600 mm o.c.</li> <li>• 12.7 mm Type X gypsum board</li> </ul>	45 min [1 h] <sup>(18)</sup>	53	47
	F28i	F28 with <ul style="list-style-type: none"> <li>• no absorptive material in cavity</li> <li>• resilient metal channels spaced 400 mm o.c.</li> <li>• 12.7 mm regular gypsum board</li> </ul>	-	44	36
	F28j	F28 with <ul style="list-style-type: none"> <li>• no absorptive material in cavity</li> <li>• resilient metal channels spaced 600 mm o.c.</li> <li>• 12.7 mm regular gypsum board</li> </ul>	-	46	39
	F28k	F28 with <ul style="list-style-type: none"> <li>• absorptive material in cavity</li> <li>• resilient metal channels spaced 400 mm o.c.</li> <li>• 12.7 mm regular gypsum board</li> </ul>	-	51	44
	F28l	F28 with <ul style="list-style-type: none"> <li>• absorptive material in cavity</li> <li>• resilient metal channels spaced 600 mm o.c.</li> <li>• 12.7 mm regular gypsum board</li> </ul>	-	53	47
	<b>F29</b>	<ul style="list-style-type: none"> <li>• one subfloor layer 11 mm sanded plywood, or OSB or waferboard</li> <li>• one subfloor layer of 15.5 mm plywood, OSB or waferboard, or 17 mm tongue and groove lumber</li> <li>• on wood trusses spaced not more than 600 mm o.c.</li> <li>• with or without absorptive material in cavity</li> <li>• resilient metal channels spaced 400 mm or 600 mm o.c.</li> <li>• 1 layer of gypsum board on ceiling side</li> </ul>			
	F29a	F29 with <ul style="list-style-type: none"> <li>• no absorptive material in cavity</li> <li>• resilient metal channels spaced 400 mm o.c.</li> <li>• 15.9 mm Type X gypsum board</li> </ul>	-	44	35

	F29b	F29 with • no absorptive material in cavity • resilient metal channels spaced 600 mm o.c. • 15.9 mm Type X gypsum board	-	46	37
	F29c	F29 with • absorptive material in cavity • resilient metal channels spaced 400 mm o.c. • 15.9 mm Type X gypsum board	30 min [45 min] <sup>(25)</sup>	51	43
	F29d	F29 with • absorptive material in cavity • resilient metal channels spaced 600 mm o.c. • 15.9 mm Type X gypsum board	-	53	45
	F29e	F29 with • no absorptive material in cavity • resilient metal channels spaced 400 mm o.c. • 12.7 mm Type X gypsum board	-	43	33
	F29f	F29 with • no absorptive material in cavity • resilient metal channels spaced 600 mm o.c. • 12.7 mm Type X gypsum board	-	45	36
	F29g	F29 with • absorptive material in cavity • resilient metal channels spaced 400 mm o.c. • 12.7 mm Type X gypsum board	-	50	41
	F29h	F29 with • absorptive material in cavity • resilient metal channels spaced 600 mm o.c. • 12.7 mm Type X gypsum board	-	52	44
	F29i	F29 with • no absorptive material in cavity • resilient metal channels spaced 400 mm o.c. • 12.7 mm regular gypsum board	-	42	34
	F29j	F29 with • no absorptive material in cavity • resilient metal channels spaced 600 mm o.c. • 12.7 mm regular gypsum board	-	44	36
	F29k	F29 with • absorptive material in cavity • resilient metal channels spaced 400 mm o.c. • 12.7 mm regular gypsum board	-	49	41
	F29l	F29 with • absorptive material in cavity	-	51	44

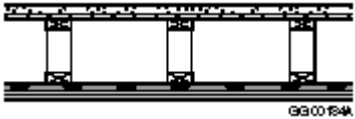
		<ul style="list-style-type: none"> <li>• resilient metal channels spaced 600 mm o.c.</li> <li>• 12.7 mm regular gypsum board</li> </ul>			
	<b>F30</b>	<ul style="list-style-type: none"> <li>• one subfloor layer 11 mm sanded plywood, or OSB or waferboard</li> <li>• one subfloor layer of 15.5 mm plywood, OSB or waferboard, or 17 mm tongue and groove lumber</li> <li>• on wood trusses spaced not more than 600 mm o.c.</li> <li>• with or without absorptive material in cavity</li> <li>• resilient metal channels spaced 400 mm or 600 mm o.c.</li> <li>• 2 layers of gypsum board on ceiling side</li> </ul>			
	F30a	<ul style="list-style-type: none"> <li>F30 with</li> <li>• no absorptive material in cavity</li> <li>• resilient metal channels spaced 400 mm o.c.</li> <li>• 15.9 mm Type X gypsum board</li> </ul>	1 h	49	39
	F30b	<ul style="list-style-type: none"> <li>F30 with</li> <li>• no absorptive material in cavity</li> <li>• resilient metal channels spaced 600 mm o.c.</li> <li>• 15.9 mm Type X gypsum board</li> </ul>	1 h	51	42
	F30c	<ul style="list-style-type: none"> <li>F30 with</li> <li>• absorptive material in cavity</li> <li>• resilient metal channels spaced 400 mm o.c.</li> <li>• 15.9 mm Type X gypsum board</li> </ul>	1 h [1.5 h] <sup>(26)</sup>	56 [58] <sup>(26)</sup>	47 [50] <sup>(26)</sup>
	F30d	<ul style="list-style-type: none"> <li>F30 with</li> <li>• absorptive material in cavity</li> <li>• resilient metal channels spaced 600 mm o.c.</li> <li>• 15.9 mm Type X gypsum board</li> </ul>	45 min [1 h] <sup>(18)</sup>	58	50
	F30e	<ul style="list-style-type: none"> <li>F30 with</li> <li>• no absorptive material in cavity</li> <li>• resilient metal channels spaced 400 mm o.c.</li> <li>• 12.7 mm Type X gypsum board</li> </ul>	1 h	47	38
	F30f	<ul style="list-style-type: none"> <li>F30 with</li> <li>• no absorptive material in cavity</li> <li>• resilient metal channels spaced 600 mm o.c.</li> <li>• 12.7 mm Type X gypsum board</li> </ul>	1 h	49	40
	F30g	<ul style="list-style-type: none"> <li>F30 with</li> <li>• absorptive material in cavity</li> <li>• resilient metal channels spaced 400 mm o.c.</li> <li>• 12.7 mm Type X gypsum board</li> </ul>	1 h	54	46
	F30h	<ul style="list-style-type: none"> <li>F30 with</li> <li>• absorptive material in cavity</li> <li>• resilient metal channels spaced 600 mm o.c.</li> </ul>	45 min [1 h] <sup>(18)</sup>	56	48

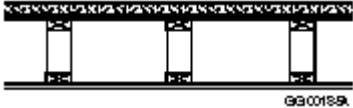
		<ul style="list-style-type: none"> <li>• 12.7 mm Type X gypsum board</li> </ul>			
	F30i	F30 with <ul style="list-style-type: none"> <li>• no absorptive material in cavity</li> <li>• resilient metal channels spaced 400 mm o.c.</li> <li>• 12.7 mm regular gypsum board</li> </ul>	-	47	37
	F30j	F30 with <ul style="list-style-type: none"> <li>• no absorptive material in cavity</li> <li>• resilient metal channels spaced 600 mm o.c.</li> <li>• 12.7 mm regular gypsum board</li> </ul>	-	49	40
	F30k	F30 with <ul style="list-style-type: none"> <li>• absorptive material in cavity</li> <li>• resilient metal channels spaced 400 mm o.c.</li> <li>• 12.7 mm regular gypsum board</li> </ul>	-	54	45
	F30l	F30 with <ul style="list-style-type: none"> <li>• absorptive material in cavity</li> <li>• resilient metal channels spaced 600 mm o.c.</li> <li>• 12.7 mm regular gypsum board</li> </ul>	-	56	48
	<b>F31</b>	<ul style="list-style-type: none"> <li>• 25 mm gypsum-concrete topping (at least 44 kg/m<sup>2</sup>)</li> <li>• subfloor of 15.5 mm plywood, OSB or waferboard, or 17 mm tongue and groove lumber</li> <li>• on wood trusses spaced not more than 600 mm o.c.</li> <li>• with or without absorptive material in cavity</li> <li>• 1 layer of gypsum board on ceiling side</li> </ul>			
	F31a	F31 with <ul style="list-style-type: none"> <li>• no absorptive material in cavity</li> <li>• 15.9 mm Type X gypsum board</li> </ul>	-	41	17
	F31b	F31 with <ul style="list-style-type: none"> <li>• absorptive material in cavity</li> <li>• 15.9 mm Type X gypsum board</li> </ul>	-	43	20
	F31c	F31 with <ul style="list-style-type: none"> <li>• no absorptive material in cavity</li> <li>• 12.7 mm Type X gypsum board</li> </ul>	-	40	17
	F31d	F31 with <ul style="list-style-type: none"> <li>• absorptive material in cavity</li> <li>• 12.7 mm Type X gypsum board</li> </ul>	-	42	20
	F31e	F31 with <ul style="list-style-type: none"> <li>• no absorptive material in cavity</li> <li>• 12.7 mm regular gypsum board</li> </ul>	-	39	16
	F31f	F31 with <ul style="list-style-type: none"> <li>• absorptive material in cavity</li> <li>• 12.7 mm regular gypsum board</li> </ul>	-	41	19


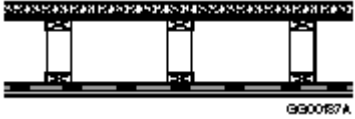


	<b>F32</b>	<ul style="list-style-type: none"> <li>• 25 mm gypsum-concrete topping (at least 44 kg/m<sup>2</sup>)</li> <li>• subfloor of 15.5 mm plywood, OSB or waferboard, or 17 mm tongue and groove lumber</li> <li>• on wood trusses spaced not more than 600 mm o.c.</li> <li>• with or without absorptive material in cavity</li> <li>• 2 layers of gypsum board on ceiling side</li> </ul>			
	F32a	<ul style="list-style-type: none"> <li>• F32 with</li> <li>• wood trusses spaced 400 mm o.c.</li> <li>• no absorptive material in cavity</li> <li>• 15.9 mm Type X gypsum board</li> </ul>	1 h	46	20
	F32b	<ul style="list-style-type: none"> <li>• F32 with</li> <li>• wood trusses spaced 600 mm o.c.</li> <li>• no absorptive material in cavity</li> <li>• 15.9 mm Type X gypsum board</li> </ul>	1 h	47	20
	F32c	<ul style="list-style-type: none"> <li>• F32 with</li> <li>• wood trusses spaced 400 mm o.c.</li> <li>• absorptive material in cavity</li> <li>• 15.9 mm Type X gypsum board</li> </ul>	45 min [1 h] <sup>(15)</sup>	48	23
	F32d	<ul style="list-style-type: none"> <li>• F32 with</li> <li>• wood trusses spaced 600 mm o.c.</li> <li>• absorptive material in cavity</li> <li>• 15.9 mm Type X gypsum board</li> </ul>	45 min	49	23
	F32e	<ul style="list-style-type: none"> <li>• F32 with</li> <li>• wood trusses spaced 400 mm o.c.</li> <li>• no absorptive material in cavity</li> <li>• 12.7 mm Type X gypsum board</li> </ul>	1 h	44	19
	F32f	<ul style="list-style-type: none"> <li>• F32 with</li> <li>• wood trusses spaced 600 mm o.c.</li> <li>• no absorptive material in cavity</li> <li>• 12.7 mm Type X gypsum board</li> </ul>	45 min	45	19
	F32g	<ul style="list-style-type: none"> <li>• F32 with</li> <li>• absorptive material in cavity</li> <li>• 12.7 mm Type X gypsum board</li> </ul>	-	46	19
	F32h	<ul style="list-style-type: none"> <li>• F32 with</li> <li>• no absorptive material in cavity</li> <li>• 12.7 mm regular gypsum board</li> </ul>	-	44	19
	F32i	<ul style="list-style-type: none"> <li>• F32 with</li> <li>• absorptive material in cavity</li> <li>• 12.7 mm regular gypsum board</li> </ul>	-	46	22
	<b>F33</b>	<ul style="list-style-type: none"> <li>• 25 mm gypsum-concrete topping (at least 44 kg/m<sup>2</sup>)</li> <li>• subfloor of 15.5 mm plywood, OSB or waferboard, or 17 mm tongue and groove lumber</li> <li>• on wood trusses spaced not more than 600 mm o.c.</li> <li>• with or without absorptive material in cavity</li> </ul>			


		<ul style="list-style-type: none"> <li>• resilient metal channels spaced 400 mm or 600 mm o.c.</li> <li>• 1 layer of gypsum board on ceiling side</li> </ul>			
	F33a	<ul style="list-style-type: none"> <li>• F33 with</li> <li>• no absorptive material in cavity</li> <li>• resilient metal channels spaced 400 mm o.c.</li> <li>• 15.9 mm Type X gypsum board</li> </ul>	-	53	26
	F33b	<ul style="list-style-type: none"> <li>• F33 with</li> <li>• no absorptive material in cavity</li> <li>• resilient metal channels spaced 600 mm o.c.</li> <li>• 15.9 mm Type X gypsum board</li> </ul>	-	55	26
	F33c	<ul style="list-style-type: none"> <li>• F33 with</li> <li>• absorptive material in cavity</li> <li>• resilient metal channels spaced 400 mm o.c.</li> <li>• 15.9 mm Type X gypsum board</li> </ul>	30 min [45 min] <sup>(25)</sup>	60	34
	F33d	<ul style="list-style-type: none"> <li>• F33 with</li> <li>• absorptive material in cavity</li> <li>• resilient metal channels spaced 600 mm o.c.</li> <li>• 15.9 mm Type X gypsum board</li> </ul>	-	62	34
	F33e	<ul style="list-style-type: none"> <li>• F33 with</li> <li>• no absorptive material in cavity</li> <li>• resilient metal channels spaced 400 mm o.c.</li> <li>• 12.7 mm Type X gypsum board</li> </ul>	-	52	26
	F33f	<ul style="list-style-type: none"> <li>• F33 with</li> <li>• no absorptive material in cavity</li> <li>• resilient metal channels spaced 600 mm o.c.</li> <li>• 12.7 mm Type X gypsum board</li> </ul>	-	54	26
	F33g	<ul style="list-style-type: none"> <li>• F33 with</li> <li>• absorptive material in cavity</li> <li>• resilient metal channels spaced 400 mm o.c.</li> <li>• 12.7 mm Type X gypsum board</li> </ul>	-	59	34
	F33h	<ul style="list-style-type: none"> <li>• F33 with</li> <li>• absorptive material in cavity</li> <li>• resilient metal channels spaced 600 mm o.c.</li> <li>• 12.7 mm Type X gypsum board</li> </ul>	-	61	34
	F33i	<ul style="list-style-type: none"> <li>• F33 with</li> <li>• no absorptive material in cavity</li> <li>• resilient metal channels spaced 400 mm o.c.</li> <li>• 12.7 mm regular gypsum board</li> </ul>	-	51	25
	F33j	<ul style="list-style-type: none"> <li>• F33 with</li> <li>• no absorptive material in cavity</li> <li>• resilient metal channels spaced 600 mm o.c.</li> <li>• 12.7 mm regular gypsum board</li> </ul>	-	53	25

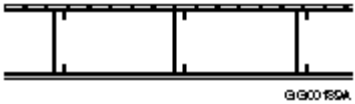
	F33k	<ul style="list-style-type: none"> <li>F33 with</li> <li>• absorptive material in cavity</li> <li>• resilient metal channels spaced 400 mm o.c.</li> <li>• 12.7 mm regular gypsum board</li> </ul>	-	58	33
	F33l	<ul style="list-style-type: none"> <li>F33 with</li> <li>• absorptive material in cavity</li> <li>• resilient metal channels spaced 600 mm o.c.</li> <li>• 12.7 mm regular gypsum board</li> </ul>	-	60	33
	<b>F34</b>	<ul style="list-style-type: none"> <li>• 25 mm gypsum-concrete topping (at least 44 kg/m<sup>2</sup>)</li> <li>• subfloor of 15.5 mm plywood, OSB or waferboard, or 17 mm tongue and groove lumber</li> <li>• on wood trusses spaced not more than 600 mm o.c.</li> <li>• with or without absorptive material in cavity</li> <li>• resilient metal channels spaced 400 mm or 600 mm o.c.</li> <li>• 2 layers of gypsum board on ceiling side</li> </ul>			
	F34a	<ul style="list-style-type: none"> <li>F34 with</li> <li>• no absorptive material in cavity</li> <li>• resilient metal channels spaced 400 mm o.c.</li> <li>• 15.9 mm Type X gypsum board</li> </ul>	1 h	57	29
	F34b	<ul style="list-style-type: none"> <li>F34 with</li> <li>• no absorptive material in cavity</li> <li>• resilient metal channels spaced 600 mm o.c.</li> <li>• 15.9 mm Type X gypsum board</li> </ul>	1 h	60	29
	F34c	<ul style="list-style-type: none"> <li>F34 with</li> <li>• absorptive material in cavity</li> <li>• resilient metal channels spaced 400 mm o.c.</li> <li>• 15.9 mm Type X gypsum board</li> </ul>	1 h [1.5 h] <sup>(26)</sup>	65 [67] <sup>(26)</sup>	37
	F34d	<ul style="list-style-type: none"> <li>F34 with</li> <li>• absorptive material in cavity</li> <li>• resilient metal channels spaced 600 mm o.c.</li> <li>• 15.9 mm Type X gypsum board</li> </ul>	45 min [1 h] <sup>(18)</sup>	67	37
	F34e	<ul style="list-style-type: none"> <li>F34 with</li> <li>• no absorptive material in cavity</li> <li>• resilient metal channels spaced 400 mm o.c.</li> <li>• 12.7 mm Type X gypsum board</li> </ul>	1 h	56	28
	F34f	<ul style="list-style-type: none"> <li>F34 with</li> <li>• no absorptive material in cavity</li> <li>• resilient metal channels spaced 600 mm o.c.</li> <li>• 12.7 mm Type X gypsum board</li> </ul>	1 h	58	28
	F34g	<ul style="list-style-type: none"> <li>F34 with</li> <li>• absorptive material in cavity</li> </ul>	1 h	63	36

		<ul style="list-style-type: none"> <li>resilient metal channels spaced 400 mm o.c.</li> <li>12.7 mm Type X gypsum board</li> </ul>			
	F34h	<ul style="list-style-type: none"> <li>F34 with absorptive material in cavity</li> <li>resilient metal channels spaced 600 mm o.c.</li> <li>12.7 mm Type X gypsum board</li> </ul>	45 min [1 h] <sup>(18)</sup>	65	36
	F34i	<ul style="list-style-type: none"> <li>F34 with no absorptive material in cavity</li> <li>resilient metal channels spaced 400 mm o.c.</li> <li>12.7 mm regular gypsum board</li> </ul>	-	56	28
	F34j	<ul style="list-style-type: none"> <li>F34 with no absorptive material in cavity</li> <li>resilient metal channels spaced 600 mm o.c.</li> <li>12.7 mm regular gypsum board</li> </ul>	-	58	28
	F34k	<ul style="list-style-type: none"> <li>F34 with absorptive material in cavity</li> <li>resilient metal channels spaced 400 mm o.c.</li> <li>12.7 mm regular gypsum board</li> </ul>	-	63	36
	F34l	<ul style="list-style-type: none"> <li>F34 with absorptive material in cavity</li> <li>resilient metal channels spaced 600 mm o.c.</li> <li>12.7 mm regular gypsum board</li> </ul>	-	65	36
	<b>F35</b>	<ul style="list-style-type: none"> <li>38 mm concrete topping (at least 70 kg/m<sup>2</sup>)</li> <li>subfloor of 15.5 mm plywood, OSB or waferboard, or 17 mm tongue and groove lumber</li> <li>on wood trusses spaced not more than 600 mm o.c.</li> <li>with or without absorptive material in cavity</li> <li>1 layer of gypsum board on ceiling side</li> </ul>			
	F35a	<ul style="list-style-type: none"> <li>F35 with no absorptive material in cavity</li> <li>15.9 mm Type X gypsum board</li> </ul>	-	45	26
	F35b	<ul style="list-style-type: none"> <li>F35 with absorptive material in cavity</li> <li>15.9 mm Type X gypsum board</li> </ul>	-	47	29
	F35c	<ul style="list-style-type: none"> <li>F35 with no absorptive material in cavity</li> <li>12.7 mm Type X gypsum board</li> </ul>	-	43	26
	F35d	<ul style="list-style-type: none"> <li>F35 with absorptive material in cavity</li> <li>12.7 mm Type X gypsum board</li> </ul>	-	45	29
	F35e	<ul style="list-style-type: none"> <li>F35 with no absorptive material in cavity</li> </ul>	-	43	26

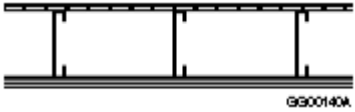
		<ul style="list-style-type: none"> <li>• 12.7 mm regular gypsum board</li> </ul>			
	F35f	<ul style="list-style-type: none"> <li>• F35 with</li> <li>• absorptive material in cavity</li> <li>• 12.7 mm regular gypsum board</li> </ul>	-	45	29
	<b>F36</b>	<ul style="list-style-type: none"> <li>• 38 mm concrete topping (at least 70 kg/m<sup>2</sup>)</li> <li>• subfloor of 15.5 mm plywood, OSB or waferboard, or 17 mm tongue and groove lumber</li> <li>• on wood trusses spaced not more than 600 mm o.c.</li> <li>• with or without absorptive material in cavity</li> <li>• 2 layers of gypsum board on ceiling side</li> </ul>			
	F36a	<ul style="list-style-type: none"> <li>• F36 with</li> <li>• wood trusses spaced 400 mm o.c.</li> <li>• no absorptive material in cavity</li> <li>• 15.9 mm Type X gypsum board</li> </ul>	1 h	49	28
	F36b	<ul style="list-style-type: none"> <li>• F36 with</li> <li>• wood trusses spaced 600 mm o.c.</li> <li>• no absorptive material in cavity</li> <li>• 15.9 mm Type X gypsum board</li> </ul>	1 h	50	28
	F36c	<ul style="list-style-type: none"> <li>• F36 with</li> <li>• wood trusses spaced 400 mm o.c.</li> <li>• absorptive material in cavity</li> <li>• 15.9 mm Type X gypsum board</li> </ul>	45 min [1 h] <sup>(15)</sup>	51	31
	F36d	<ul style="list-style-type: none"> <li>• F36 with</li> <li>• wood trusses spaced 600 mm o.c.</li> <li>• absorptive material in cavity</li> <li>• 15.9 mm Type X gypsum board</li> </ul>	45 min	52	31
	F36e	<ul style="list-style-type: none"> <li>• F36 with</li> <li>• wood trusses spaced 400 mm o.c.</li> <li>• no absorptive material in cavity</li> <li>• 12.7 mm Type X gypsum board</li> </ul>	1 h	48	27
	F36f	<ul style="list-style-type: none"> <li>• F36 with</li> <li>• wood trusses spaced 600 mm o.c.</li> <li>• no absorptive material in cavity</li> <li>• 12.7 mm Type X gypsum board</li> </ul>	45 min	49	27
	F36g	<ul style="list-style-type: none"> <li>• F36 with</li> <li>• absorptive material in cavity</li> <li>• 12.7 mm Type X gypsum board</li> </ul>	-	50	30
	F36h	<ul style="list-style-type: none"> <li>• F36 with</li> <li>• no absorptive material in cavity</li> <li>• 12.7 mm regular gypsum board</li> </ul>	-	47	27
	F36i	<ul style="list-style-type: none"> <li>• F36 with</li> <li>• absorptive material in cavity</li> <li>• 12.7 mm regular gypsum board</li> </ul>	-	49	30
	<b>F37</b>	<ul style="list-style-type: none"> <li>• 38 mm concrete topping (at least 70 kg/m<sup>2</sup>)</li> </ul>			

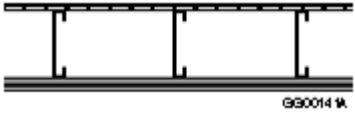
		<ul style="list-style-type: none"> <li>• subfloor of 15.5 mm plywood, OSB or waferboard, or 17 mm tongue and groove lumber</li> <li>• on wood trusses spaced not more than 600 mm o.c.</li> <li>• with or without absorptive material in cavity</li> <li>• resilient metal channels spaced 400 mm or 600 mm o.c.</li> <li>• 1 layer of gypsum board on ceiling side</li> </ul>			
	F37a	<ul style="list-style-type: none"> <li>• F37 with</li> <li>• no absorptive material in cavity</li> <li>• resilient metal channels spaced 400 mm o.c.</li> <li>• 15.9 mm Type X gypsum board</li> </ul>	45 min	56	35
	F37b	<ul style="list-style-type: none"> <li>• F37 with</li> <li>• no absorptive material in cavity</li> <li>• resilient metal channels spaced 600 mm o.c.</li> <li>• 15.9 mm Type X gypsum board</li> </ul>	-	59	35
	F37c	<ul style="list-style-type: none"> <li>• F37 with</li> <li>• absorptive material in cavity</li> <li>• resilient metal channels spaced 400 mm o.c.</li> <li>• 15.9 mm Type X gypsum board</li> </ul>	30 min [45 min] <sup>(25)</sup>	63	43
	F37d	<ul style="list-style-type: none"> <li>• F37 with</li> <li>• absorptive material in cavity</li> <li>• resilient metal channels spaced 600 mm o.c.</li> <li>• 15.9 mm Type X gypsum board</li> </ul>	-	66	43
	F37e	<ul style="list-style-type: none"> <li>• F37 with</li> <li>• no absorptive material in cavity</li> <li>• resilient metal channels spaced 400 mm o.c.</li> <li>• 12.7 mm Type X gypsum board</li> </ul>	-	55	35
	F37f	<ul style="list-style-type: none"> <li>• F37 with</li> <li>• no absorptive material in cavity</li> <li>• resilient metal channels spaced 600 mm o.c.</li> <li>• 12.7 mm Type X gypsum board</li> </ul>	-	57	35
	F37g	<ul style="list-style-type: none"> <li>• F37 with</li> <li>• absorptive material in cavity</li> <li>• resilient metal channels spaced 400 mm o.c.</li> <li>• 12.7 mm Type X gypsum board</li> </ul>	-	62	43
	F37h	<ul style="list-style-type: none"> <li>• F37 with</li> <li>• absorptive material in cavity</li> <li>• resilient metal channels spaced 600 mm o.c.</li> <li>• 12.7 mm Type X gypsum board</li> </ul>	-	64	43
	F37i	<ul style="list-style-type: none"> <li>• F37 with</li> <li>• no absorptive material in cavity</li> <li>• resilient metal channels spaced 400 mm o.c.</li> </ul>	-	54	35

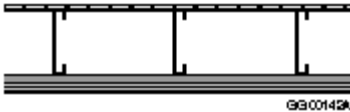
		<ul style="list-style-type: none"> <li>• 12.7 mm regular gypsum board</li> </ul>			
	F37j	F37 with <ul style="list-style-type: none"> <li>• no absorptive material in cavity</li> <li>• resilient metal channels spaced 600 mm o.c.</li> <li>• 12.7 mm regular gypsum board</li> </ul>	-	57	35
	F37k	F37 with <ul style="list-style-type: none"> <li>• absorptive material in cavity</li> <li>• resilient metal channels spaced 400 mm o.c.</li> <li>• 12.7 mm regular gypsum board</li> </ul>	-	61	43
	F37l	F37 with <ul style="list-style-type: none"> <li>• absorptive material in cavity</li> <li>• resilient metal channels spaced 600 mm o.c.</li> <li>• 12.7 mm regular gypsum board</li> </ul>	-	64	43
	<b>F38</b>	<ul style="list-style-type: none"> <li>• 38 mm concrete topping (at least 70 kg/m<sup>2</sup>)</li> <li>• subfloor of 15.5 mm plywood, OSB or waferboard, or 17 mm tongue and groove lumber</li> <li>• on wood trusses spaced not more than 600 mm o.c.</li> <li>• with or without absorptive material in cavity</li> <li>• resilient metal channels spaced 400 mm or 600 mm o.c.</li> <li>• 2 layers of gypsum board on ceiling side</li> </ul>			
	F38a	F38 with <ul style="list-style-type: none"> <li>• no absorptive material in cavity</li> <li>• resilient metal channels spaced 400 mm o.c.</li> <li>• 15.9 mm Type X gypsum board</li> </ul>	1 h	61	37
	F38b	F38 with <ul style="list-style-type: none"> <li>• no absorptive material in cavity</li> <li>• resilient metal channels spaced 600 mm o.c.</li> <li>• 15.9 mm Type X gypsum board</li> </ul>	1 h	63	37
	F38c	F38 with <ul style="list-style-type: none"> <li>• absorptive material in cavity</li> <li>• resilient metal channels spaced 400 mm o.c.</li> <li>• 15.9 mm Type X gypsum board</li> </ul>	1 h [1.5] <sup>(26)</sup>	68 [71] <sup>(26)</sup>	45
	F38d	F38 with <ul style="list-style-type: none"> <li>• absorptive material in cavity</li> <li>• resilient metal channels spaced 600 mm o.c.</li> <li>• 15.9 mm Type X gypsum board</li> </ul>	1 h	70	45
	F38e	F38 with <ul style="list-style-type: none"> <li>• no absorptive material in cavity</li> <li>• resilient metal channels spaced 400 mm o.c.</li> <li>• 12.7 mm Type X gypsum board</li> </ul>	1 h	60	36

	F38f	F38 with • no absorptive material in cavity • resilient metal channels spaced 600 mm o.c. • 12.7 mm Type X gypsum board	1 h	62	36
	F38g	F38 with • absorptive material in cavity • resilient metal channels spaced 400 mm o.c. • 12.7 mm Type X gypsum board	1 h	67	44
	F38h	F38 with • absorptive material in cavity • resilient metal channels spaced 600 mm o.c. • 12.7 mm Type X gypsum board	1 h	69	44
	F38i	F38 with • no absorptive material in cavity • resilient metal channels spaced 400 mm o.c. • 12.7 mm regular gypsum board	-	59	36
	F38j	F38 with • no absorptive material in cavity • resilient metal channels spaced 600 mm o.c. • 12.7 mm regular gypsum board	-	61	36
	F38k	F38 with • absorptive material in cavity • resilient metal channels spaced 400 mm o.c. • 12.7 mm regular gypsum board	-	66	44
	F38l	F38 with • absorptive material in cavity • resilient metal channels spaced 600 mm o.c. • 12.7 mm regular gypsum board	-	68	44
Cold-Formed-Steel Floor Joists <sup>(27)</sup>	<b>F39</b>	<ul style="list-style-type: none"> <li>• subfloor of 15.5 mm plywood, OSB or waferboard, or 17 mm tongue and groove lumber</li> <li>• on steel joists spaced not more than 600 mm o.c.</li> <li>• with or without absorptive material in cavity</li> <li>• 1 layer of gypsum board on ceiling side</li> </ul>			
	F39a	F39 with • no absorptive material in cavity • 15.9 mm Type X gypsum board	-	29	27
	F39b	F39 with • absorptive material in cavity • 15.9 mm Type X gypsum board	-	31	30
	F39c	F39 with • no absorptive material in cavity • 12.7 mm Type X gypsum board	-	27	26




	F39d	F39 with • absorptive material in cavity • 12.7 mm Type X gypsum board	-	29	29
	F39e	F39 with • no absorptive material in cavity • 12.7 mm regular gypsum board	-	27	25
	F39f	F39 with • absorptive material in cavity • 12.7 mm regular gypsum board	-	29	28
	<b>F40</b>	<ul style="list-style-type: none"> <li>• subfloor of 15.5 mm plywood, OSB or waferboard, or 17 mm tongue and groove lumber</li> <li>• on steel joists spaced not more than 600 mm o.c.</li> <li>• with or without absorptive material in cavity</li> <li>• 2 layers of gypsum board on ceiling side</li> </ul>			
	F40a	F40 with • steel joists spaced 400 mm o.c. • no absorptive material in cavity • 15.9 mm Type X gypsum board	1 h	34	31
	F40b	F40 with • steel joists spaced 600 mm o.c. • no absorptive material in cavity • 15.9 mm Type X gypsum board	45 min	35	31
	F40c	F40 with • steel joists spaced 400 mm o.c. • absorptive material in cavity • 15.9 mm Type X gypsum board	45 min	36	34
	F40d	F40 with • steel joists spaced 600 mm o.c. • absorptive material in cavity • 15.9 mm Type X gypsum board	45 min	37	34
	F40e	F40 with • steel joists spaced 400 mm o.c. • no absorptive material in cavity • 12.7 mm Type X gypsum board	1 h	32	30
	F40f	F40 with • steel joists spaced 600 mm o.c. • no absorptive material in cavity • 12.7 mm Type X gypsum board	45 min	33	30
	F40g	F40 with • steel joists spaced 400 mm o.c. • absorptive material in cavity • 12.7 mm Type X gypsum board	45 min	34	33
	F40h	F40 with • steel joists spaced 600 mm o.c. • absorptive material in cavity • 12.7 mm Type X gypsum board	45 min	35	33
	F40i	F40 with • no absorptive material in cavity	-	31	30

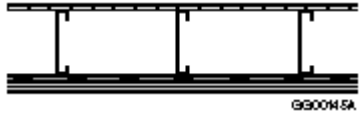
		<ul style="list-style-type: none"> <li>• 12.7 mm regular gypsum board</li> </ul>			
	F40j	<ul style="list-style-type: none"> <li>• F40 with</li> <li>• absorptive material in cavity</li> <li>• 12.7 mm regular gypsum board</li> </ul>	-	33	33
	<b>F41</b>	<ul style="list-style-type: none"> <li>• subfloor of 15.5 mm plywood, OSB or waferboard, or 17 mm tongue and groove lumber</li> <li>• on steel joists spaced not more than 600 mm o.c.</li> <li>• with or without absorptive material in cavity</li> <li>• steel furring channels spaced 400 mm or 600 mm o.c.</li> <li>• 1 layer of gypsum board on ceiling side</li> </ul>			
	F41a	<ul style="list-style-type: none"> <li>• F41 with</li> <li>• no absorptive material in cavity</li> <li>• steel furring channels spaced 400 mm o.c.</li> <li>• 15.9 mm Type X gypsum board</li> </ul>	-	34	27
	F41b	<ul style="list-style-type: none"> <li>• F41 with</li> <li>• no absorptive material in cavity</li> <li>• steel furring channels spaced 600 mm o.c.</li> <li>• 15.9 mm Type X gypsum board</li> </ul>	-	37	30
	F41c	<ul style="list-style-type: none"> <li>• F41 with</li> <li>• absorptive material in cavity</li> <li>• steel furring channels spaced 400 mm o.c.</li> <li>• 15.9 mm Type X gypsum board</li> </ul>	30 min [45 min] <sup>(25)</sup>	37	30
	F41d	<ul style="list-style-type: none"> <li>• F41 with</li> <li>• absorptive material in cavity</li> <li>• steel furring channels spaced 600 mm o.c.</li> <li>• 15.9 mm Type X gypsum board</li> </ul>	30 min	40	33
	F41e	<ul style="list-style-type: none"> <li>• F41 with</li> <li>• no absorptive material in cavity</li> <li>• steel furring channels spaced 400 mm o.c.</li> <li>• 12.7 mm Type X gypsum board</li> </ul>	-	33	26
	F41f	<ul style="list-style-type: none"> <li>• F41 with</li> <li>• no absorptive material in cavity</li> <li>• steel furring channels spaced 600 mm o.c.</li> <li>• 12.7 mm Type X gypsum board</li> </ul>	-	35	29
	F41g	<ul style="list-style-type: none"> <li>• F41 with</li> <li>• absorptive material in cavity</li> <li>• steel furring channels spaced 400 mm o.c.</li> <li>• 12.7 mm Type X gypsum board</li> </ul>	30 min [45 min] <sup>(25)</sup>	36	29
	F41h	<ul style="list-style-type: none"> <li>• F41 with</li> <li>• absorptive material in cavity</li> <li>• steel furring channels spaced 600 mm o.c.</li> </ul>	30 min	38	32

		<ul style="list-style-type: none"> <li>• 12.7 mm Type X gypsum board</li> </ul>			
	F41i	F41 with <ul style="list-style-type: none"> <li>• no absorptive material in cavity</li> <li>• steel furring channels spaced 400 mm o.c.</li> <li>• 12.7 mm regular gypsum board</li> </ul>	<30 min	32	25
	F41j	F41 with <ul style="list-style-type: none"> <li>• no absorptive material in cavity</li> <li>• steel furring channels spaced 600 mm o.c.</li> <li>• 12.7 mm regular gypsum board</li> </ul>	<30 min	35	28
	F41k	F41 with <ul style="list-style-type: none"> <li>• absorptive material in cavity</li> <li>• steel furring channels spaced 400 mm o.c.</li> <li>• 12.7 mm regular gypsum board</li> </ul>	<30 min	35	28
	F41l	F41 with <ul style="list-style-type: none"> <li>• absorptive material in cavity</li> <li>• steel furring channels spaced 600 mm o.c.</li> <li>• 12.7 mm regular gypsum board</li> </ul>	<30 min	38	31
	<b>F42</b>	<ul style="list-style-type: none"> <li>• subfloor of 15.5 mm plywood, OSB or waferboard, or 17 mm tongue and groove lumber</li> <li>• on steel joists spaced not more than 600 mm o.c.</li> <li>• with or without absorptive material in cavity</li> <li>• steel furring channels spaced 400 mm or 600 mm o.c.</li> <li>• 2 layers of gypsum board on ceiling side</li> </ul>			
	F42a	F42 with <ul style="list-style-type: none"> <li>• no absorptive material in cavity</li> <li>• steel furring channels spaced 400 mm o.c.</li> <li>• 15.9 mm Type X gypsum board</li> </ul>	1 h	39	32
	F42b	F42 with <ul style="list-style-type: none"> <li>• steel joists spaced 400 mm o.c.</li> <li>• no absorptive material in cavity</li> <li>• steel furring channels spaced 600 mm o.c.</li> <li>• 15.9 mm Type X gypsum board</li> </ul>	45 min	42	34
	F42c	F42 with <ul style="list-style-type: none"> <li>• steel joists spaced 600 mm o.c.</li> <li>• no absorptive material in cavity</li> <li>• steel furring channels spaced 600 mm o.c.</li> <li>• 15.9 mm Type X gypsum board</li> </ul>	45 min	43	34
	F42d	F42 with <ul style="list-style-type: none"> <li>• absorptive material in cavity</li> <li>• steel furring channels spaced 400 mm o.c.</li> <li>• 15.9 mm Type X gypsum board</li> </ul>	1 h	42	35

	F42e	F42 with <ul style="list-style-type: none"> <li>• steel joists spaced 400 mm o.c.</li> <li>• absorptive material in cavity</li> <li>• steel furring channels spaced 600 mm o.c.</li> <li>• 15.9 mm Type X gypsum board</li> </ul>	45 min [1 h] <sup>(28)</sup>	45	37
	F42f	F42 with <ul style="list-style-type: none"> <li>• steel joists spaced 600 mm o.c.</li> <li>• absorptive material in cavity</li> <li>• steel furring channels spaced 600 mm o.c.</li> <li>• 15.9 mm Type X gypsum board</li> </ul>	45 min [1 h] <sup>(15)</sup>	46	37
	F42g	F42 with <ul style="list-style-type: none"> <li>• no absorptive material in cavity</li> <li>• steel furring channels spaced 400 mm o.c.</li> <li>• 12.7 mm Type X gypsum board</li> </ul>	1 h	38	30
	F42h	F42 with <ul style="list-style-type: none"> <li>• steel joists spaced 400 mm o.c.</li> <li>• no absorptive material in cavity</li> <li>• steel furring channels spaced 600 mm o.c.</li> <li>• 12.7 mm Type X gypsum board</li> </ul>	45 min	40	33
	F42i	F42 with <ul style="list-style-type: none"> <li>• steel joists spaced 600 mm o.c.</li> <li>• no absorptive material in cavity</li> <li>• steel furring channels spaced 600 mm o.c.</li> <li>• 12.7 mm Type X gypsum board</li> </ul>	45 min	41	33
	F42j	F42 with <ul style="list-style-type: none"> <li>• absorptive material in cavity</li> <li>• steel furring channels spaced 400 mm o.c.</li> <li>• 12.7 mm Type X gypsum board</li> </ul>	1 h	41	33
	F42k	F42 with <ul style="list-style-type: none"> <li>• steel joists spaced 400 mm o.c.</li> <li>• absorptive material in cavity</li> <li>• steel furring channels spaced 600 mm o.c.</li> <li>• 12.7 mm Type X gypsum board</li> </ul>	45 min [1 h] <sup>(28)</sup>	43	36
	F42l	F42 with <ul style="list-style-type: none"> <li>• steel joists spaced 600 mm o.c.</li> <li>• absorptive material in cavity</li> <li>• steel furring channels spaced 600 mm o.c.</li> <li>• 12.7 mm Type X gypsum board</li> </ul>	45 min [1 h] <sup>(15)</sup>	44	36
	F42m	F42 with <ul style="list-style-type: none"> <li>• no absorptive material in cavity</li> <li>• steel furring channels spaced 400 mm o.c.</li> <li>• 12.7 mm regular gypsum board</li> </ul>	-	37	30
	F42n	F42 with <ul style="list-style-type: none"> <li>• no absorptive material in cavity</li> </ul>	-	39	33

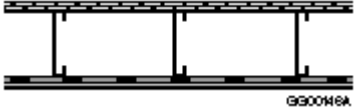
		<ul style="list-style-type: none"> <li>• steel furring channels spaced 600 mm o.c.</li> <li>• 12.7 mm regular gypsum board</li> </ul>			
	F42o	<ul style="list-style-type: none"> <li>• F42 with absorptive material in cavity</li> <li>• steel furring channels spaced 400 mm o.c.</li> <li>• 12.7 mm regular gypsum board</li> </ul>	-	40	33
	F42p	<ul style="list-style-type: none"> <li>• F42 with absorptive material in cavity</li> <li>• steel furring channels spaced 600 mm o.c.</li> <li>• 12.7 mm regular gypsum board</li> </ul>	-	42	36
	<b>F43</b>	<ul style="list-style-type: none"> <li>• subfloor of 15.5 mm plywood, OSB or waferboard, or 17 mm tongue and groove lumber</li> <li>• on steel joists spaced not more than 600 mm o.c.</li> <li>• with or without absorptive material in cavity</li> <li>• 1 layer of gypsum board attached directly to joists on ceiling side</li> <li>• resilient metal channels spaced 400 mm or 600 mm o.c. attached to joists through the gypsum board</li> <li>• 1 layer of gypsum board attached to resilient metal channels</li> </ul>			
	F43a	<ul style="list-style-type: none"> <li>• F43 with no absorptive material in cavity</li> <li>• 15.9 mm Type X gypsum board</li> <li>• resilient metal channels</li> <li>• 15.9 mm Type X gypsum board</li> </ul>	1 h	35	27
	F43b	<ul style="list-style-type: none"> <li>• F43 with absorptive material in cavity</li> <li>• 15.9 mm Type X gypsum board</li> <li>• resilient metal channels</li> <li>• 15.9 mm Type X gypsum board</li> </ul>	1 h	37	30
	F43c	<ul style="list-style-type: none"> <li>• F43 with no absorptive material in cavity</li> <li>• 12.7 mm Type X gypsum board</li> <li>• resilient metal channels</li> <li>• 12.7 mm Type X gypsum board</li> </ul>	1 h	35	27
	F43d	<ul style="list-style-type: none"> <li>• F43 with absorptive material in cavity</li> <li>• 12.7 mm Type X gypsum board</li> <li>• resilient metal channels</li> <li>• 12.7 mm Type X gypsum board</li> </ul>	1 h	37	30
	F43e	<ul style="list-style-type: none"> <li>• F43 with no absorptive material in cavity</li> <li>• 12.7 mm regular gypsum board</li> <li>• resilient metal channels</li> <li>• 12.7 mm regular gypsum board</li> </ul>	-	32	26
	F43f	<ul style="list-style-type: none"> <li>• F43 with absorptive material in cavity</li> </ul>	-	35	28

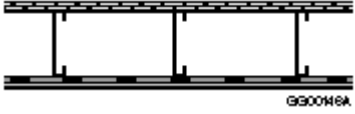
		<ul style="list-style-type: none"> <li>• 12.7 mm regular gypsum board</li> <li>• resilient metal channels</li> <li>• 12.7 mm regular gypsum board</li> </ul>			
	<b>F44</b>	<ul style="list-style-type: none"> <li>• subfloor of 15.5 mm plywood, OSB or waferboard, or 17 mm tongue and groove lumber</li> <li>• on steel joists spaced not more than 600 mm o.c.</li> <li>• with or without absorptive material in cavity</li> <li>• resilient metal channels spaced 400 mm or 600 mm o.c.</li> <li>• 1 layer of gypsum board on ceiling side</li> </ul>			
	F44a	<ul style="list-style-type: none"> <li>F44 with</li> <li>• no absorptive material in cavity</li> <li>• resilient metal channels spaced 400 mm o.c.</li> <li>• 15.9 mm Type X gypsum board</li> </ul>	-	40	33
	F44b	<ul style="list-style-type: none"> <li>F44 with</li> <li>• no absorptive material in cavity</li> <li>• resilient metal channels spaced 600 mm o.c.</li> <li>• 15.9 mm Type X gypsum board</li> </ul>	-	43	36
	F44c	<ul style="list-style-type: none"> <li>F44 with</li> <li>• absorptive material in cavity</li> <li>• resilient metal channels spaced 400 mm o.c.</li> <li>• 15.9 mm Type X gypsum board</li> </ul>	30 min [45 min] <sup>(25)</sup>	47	41
	F44d	<ul style="list-style-type: none"> <li>F44 with</li> <li>• absorptive material in cavity</li> <li>• resilient metal channels spaced 600 mm o.c.</li> <li>• 15.9 mm Type X gypsum board</li> </ul>	30 min	50	44
	F44e	<ul style="list-style-type: none"> <li>F44 with</li> <li>• no absorptive material in cavity</li> <li>• resilient metal channels spaced 400 mm o.c.</li> <li>• 12.7 mm Type X gypsum board</li> </ul>	-	39	32
	F44f	<ul style="list-style-type: none"> <li>F44 with</li> <li>• no absorptive material in cavity</li> <li>• resilient metal channels spaced 600 mm o.c.</li> <li>• 12.7 mm Type X gypsum board</li> </ul>	-	41	35
	F44g	<ul style="list-style-type: none"> <li>F44 with</li> <li>• absorptive material in cavity</li> <li>• resilient metal channels spaced 400 mm o.c.</li> <li>• 12.7 mm Type X gypsum board</li> </ul>	30 min [45 min] <sup>(25)</sup>	46	40
	F44h	<ul style="list-style-type: none"> <li>F44 with</li> <li>• absorptive material in cavity</li> <li>• resilient metal channels spaced 600 mm o.c.</li> <li>• 12.7 mm Type X gypsum board</li> </ul>	30 min	48	43

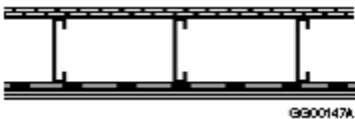
	F44i	F44 with <ul style="list-style-type: none"> <li>• no absorptive material in cavity</li> <li>• resilient metal channels spaced 400 mm o.c.</li> <li>• 12.7 mm regular gypsum board</li> </ul>	< 30 min	38	31
	F44j	F44 with <ul style="list-style-type: none"> <li>• no absorptive material in cavity</li> <li>• resilient metal channels spaced 600 mm o.c.</li> <li>• 12.7 mm regular gypsum board</li> </ul>	< 30 min	41	34
	F44k	F44 with <ul style="list-style-type: none"> <li>• absorptive material in cavity</li> <li>• resilient metal channels spaced 400 mm o.c.</li> <li>• 12.7 mm regular gypsum board</li> </ul>	< 30 min	45	39
	F44l	F44 with <ul style="list-style-type: none"> <li>• absorptive material in cavity</li> <li>• resilient metal channels spaced 600 mm o.c.</li> <li>• 12.7 mm regular gypsum board</li> </ul>	< 30 min	48	42
	<b>F45</b>	<ul style="list-style-type: none"> <li>• subfloor of 15.5 mm plywood, OSB or waferboard, or 17 mm tongue and groove lumber</li> <li>• on steel joists spaced not more than 600 mm o.c.</li> <li>• with or without absorptive material in cavity</li> <li>• resilient metal channels spaced 400 mm or 600 mm o.c.</li> <li>• 2 layers of gypsum board on ceiling side</li> </ul>			
	F45a	F45 with <ul style="list-style-type: none"> <li>• no absorptive material in cavity</li> <li>• resilient metal channels spaced 400 mm o.c.</li> <li>• 15.9 mm Type X gypsum board</li> </ul>	1 h	45	38
	F45b	F45 with <ul style="list-style-type: none"> <li>• steel joists spaced 400 mm o.c.</li> <li>• no absorptive material in cavity</li> <li>• resilient metal channels spaced 600 mm o.c.</li> <li>• 15.9 mm Type X gypsum board</li> </ul>	45 min	48	40
	F45c	F45 with <ul style="list-style-type: none"> <li>• steel joists spaced 600 mm o.c.</li> <li>• no absorptive material in cavity</li> <li>• resilient metal channels spaced 600 mm o.c.</li> <li>• 15.9 mm Type X gypsum board</li> </ul>	45 min	49	40
	F45d	F45 with <ul style="list-style-type: none"> <li>• absorptive material in cavity</li> <li>• resilient metal channels spaced 400 mm o.c.</li> <li>• 15.9 mm Type X gypsum board</li> </ul>	1 h	52	46
	F45e	F45 with <ul style="list-style-type: none"> <li>• steel joists spaced 400 mm o.c.</li> </ul>	45 min [1 h] <sup>(28)</sup>	55	48

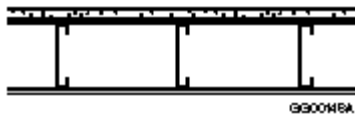
		<ul style="list-style-type: none"> <li>• absorptive material in cavity</li> <li>• resilient metal channels spaced 600 mm o.c.</li> <li>• 15.9 mm Type X gypsum board</li> </ul>			
	F45f	<p>F45 with</p> <ul style="list-style-type: none"> <li>• steel joists spaced 600 mm o.c.</li> <li>• absorptive material in cavity</li> <li>• resilient metal channels spaced 600 mm o.c.</li> <li>• 15.9 mm Type X gypsum board</li> </ul>	45 min [1 h] <sup>(15)</sup>	56	48
	F45g	<p>F45 with</p> <ul style="list-style-type: none"> <li>• no absorptive material in cavity</li> <li>• resilient metal channels spaced 400 mm o.c.</li> <li>• 12.7 mm Type X gypsum board</li> </ul>	1 h	44	36
	F45h	<p>F45 with</p> <ul style="list-style-type: none"> <li>• steel joists spaced 400 mm o.c.</li> <li>• no absorptive material in cavity</li> <li>• resilient metal channels spaced 600 mm o.c.</li> <li>• 12.7 mm Type X gypsum board</li> </ul>	45 min	46	39
	F45i	<p>F45 with</p> <ul style="list-style-type: none"> <li>• steel joists spaced 600 mm o.c.</li> <li>• no absorptive material in cavity</li> <li>• resilient metal channels spaced 600 mm o.c.</li> <li>• 12.7 mm Type X gypsum board</li> </ul>	45 min	47	39
	F45j	<p>F45 with</p> <ul style="list-style-type: none"> <li>• absorptive material in cavity</li> <li>• resilient metal channels spaced 400 mm o.c.</li> <li>• 12.7 mm Type X gypsum board</li> </ul>	1 h	51	44
	F45k	<p>F45 with</p> <ul style="list-style-type: none"> <li>• steel joists spaced 400 mm o.c.</li> <li>• absorptive material in cavity</li> <li>• resilient metal channels spaced 600 mm o.c.</li> <li>• 12.7 mm Type X gypsum board</li> </ul>	45 min [1 h] <sup>(28)</sup>	53	47
	F45l	<p>F45 with</p> <ul style="list-style-type: none"> <li>• steel joists spaced 600 mm o.c.</li> <li>• absorptive material in cavity</li> <li>• resilient metal channels spaced 600 mm o.c.</li> <li>• 12.7 mm Type X gypsum board</li> </ul>	45 min [1 h] <sup>(15)</sup>	54	47
	F45m	<p>F45 with</p> <ul style="list-style-type: none"> <li>• no absorptive material in cavity</li> <li>• resilient metal channels spaced 400 mm o.c.</li> <li>• 12.7 mm regular gypsum board</li> </ul>	-	43	36
	F45n	<p>F45 with</p> <ul style="list-style-type: none"> <li>• no absorptive material in cavity</li> <li>• resilient metal channels spaced 600 mm o.c.</li> <li>• 12.7 mm regular gypsum board</li> </ul>	-	45	39




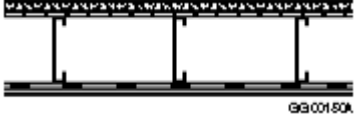
	F45o	<ul style="list-style-type: none"> <li>F45 with</li> <li>• absorptive material in cavity</li> <li>• resilient metal channels spaced 400 mm o.c.</li> <li>• 12.7 mm regular gypsum board</li> </ul>	-	50	44
	F45p	<ul style="list-style-type: none"> <li>F45 with</li> <li>• absorptive material in cavity</li> <li>• resilient metal channels spaced 600 mm o.c.</li> <li>• 12.7 mm regular gypsum board</li> </ul>	-	52	47
	<b>F46</b>	<ul style="list-style-type: none"> <li>• one subfloor layer of 11 mm sanded plywood, or OSB or waferboard</li> <li>• one subfloor layer of 15.5 mm plywood, OSB or waferboard, or 17 mm tongue and groove lumber</li> <li>• on steel joists spaced not more than 600 mm o.c.</li> <li>• with or without absorptive material in cavity</li> <li>• resilient metal channels spaced 400 mm or 600 mm o.c.</li> <li>• 1 layer of gypsum board on ceiling side</li> </ul>			
	F46a	<ul style="list-style-type: none"> <li>F46 with</li> <li>• no absorptive material in cavity</li> <li>• resilient metal channels spaced 400 mm o.c.</li> <li>• 15.9 mm Type X gypsum board</li> </ul>	-	43	34
	F46b	<ul style="list-style-type: none"> <li>F46 with</li> <li>• no absorptive material in cavity</li> <li>• resilient metal channels spaced 600 mm o.c.</li> <li>• 15.9 mm Type X gypsum board</li> </ul>	-	46	37
	F46c	<ul style="list-style-type: none"> <li>F46 with</li> <li>• absorptive material in cavity</li> <li>• resilient metal channels spaced 400 mm o.c.</li> <li>• 15.9 mm Type X gypsum board</li> </ul>	-	50	42
	F46d	<ul style="list-style-type: none"> <li>F46 with</li> <li>• absorptive material in cavity</li> <li>• resilient metal channels spaced 600 mm o.c.</li> <li>• 15.9 mm Type X gypsum board</li> </ul>	-	53	45
	F46e	<ul style="list-style-type: none"> <li>F46 with</li> <li>• no absorptive material in cavity</li> <li>• resilient metal channels spaced 400 mm o.c.</li> <li>• 12.7 mm Type X gypsum board</li> </ul>	-	42	33
	F46f	<ul style="list-style-type: none"> <li>F46 with</li> <li>• no absorptive material in cavity</li> <li>• resilient metal channels spaced 600 mm o.c.</li> <li>• 12.7 mm Type X gypsum board</li> </ul>	-	44	36
	F46g	<ul style="list-style-type: none"> <li>F46 with</li> <li>• absorptive material in cavity</li> </ul>	-	49	41


		<ul style="list-style-type: none"> <li>• resilient metal channels spaced 400 mm o.c.</li> <li>• 12.7 mm Type X gypsum board</li> </ul>			
	F46h	<ul style="list-style-type: none"> <li>• F46 with absorptive material in cavity</li> <li>• resilient metal channels spaced 600 mm o.c.</li> <li>• 12.7 mm Type X gypsum board</li> </ul>	-	51	44
	F46i	<ul style="list-style-type: none"> <li>• F46 with no absorptive material in cavity</li> <li>• resilient metal channels spaced 400 mm o.c.</li> <li>• 12.7 mm regular gypsum board</li> </ul>	-	41	33
	F46j	<ul style="list-style-type: none"> <li>• F46 with no absorptive material in cavity</li> <li>• resilient metal channels spaced 600 mm o.c.</li> <li>• 12.7 mm regular gypsum board</li> </ul>	-	44	36
	F46k	<ul style="list-style-type: none"> <li>• F46 with absorptive material in cavity</li> <li>• resilient metal channels spaced 400 mm o.c.</li> <li>• 12.7 mm regular gypsum board</li> </ul>	-	48	41
	F46l	<ul style="list-style-type: none"> <li>• F46 with absorptive material in cavity</li> <li>• resilient metal channels spaced 600 mm o.c.</li> <li>• 12.7 mm regular gypsum board</li> </ul>	-	51	44
	<b>F47</b>	<ul style="list-style-type: none"> <li>• one subfloor layer of 15.5 mm plywood, or OSB or waferboard</li> <li>• one subfloor layer of 15.5 mm plywood, OSB or waferboard, or 17 mm tongue and groove lumber</li> <li>• on steel joists spaced not more than 400 mm o.c.</li> <li>• with or without absorptive material in cavity</li> <li>• resilient metal channels spaced 400 mm or 600 mm o.c.</li> <li>• 1 layer of gypsum board on ceiling side</li> </ul>			
	F47a	<ul style="list-style-type: none"> <li>• F47 with no absorptive material in cavity</li> <li>• resilient metal channels spaced 400 mm o.c.</li> <li>• 15.9 mm Type X gypsum board</li> </ul>	30 min	45	35
	F47b	<ul style="list-style-type: none"> <li>• F47 with no absorptive material in cavity</li> <li>• resilient metal channels spaced 600 mm o.c.</li> <li>• 15.9 mm Type X gypsum board</li> </ul>	30 min	47	38
	F47c	<ul style="list-style-type: none"> <li>• F47 with absorptive material in cavity</li> <li>• resilient metal channels spaced 400 mm o.c.</li> </ul>	30 min [45 min] <sup>(18)</sup> [1 h] <sup>(28)</sup>	51	45

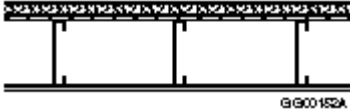
		<ul style="list-style-type: none"> <li>• 15.9 mm Type X gypsum board</li> </ul>			
	F47d	<ul style="list-style-type: none"> <li>• F47 with</li> <li>• absorptive material in cavity</li> <li>• resilient metal channels spaced 600 mm o.c.</li> <li>• 15.9 mm Type X gypsum board</li> </ul>	[30 min] <sup>(18)</sup> [45 min] <sup>(28)</sup>	53	47
	F47e	<ul style="list-style-type: none"> <li>• F47 with</li> <li>• no absorptive material in cavity</li> <li>• resilient metal channels spaced 400 mm o.c.</li> <li>• 12.7 mm Type X gypsum board</li> </ul>	30 min	43	44
	F47f	<ul style="list-style-type: none"> <li>• F47 with</li> <li>• no absorptive material in cavity</li> <li>• resilient metal channels spaced 600 mm o.c.</li> <li>• 12.7 mm Type X gypsum board</li> </ul>	-	45	47
	F47g	<ul style="list-style-type: none"> <li>• F47 with</li> <li>• absorptive material in cavity</li> <li>• resilient metal channels spaced 400 mm o.c.</li> <li>• 12.7 mm Type X gypsum board</li> </ul>	[30 min] <sup>(18)</sup> [45 min] <sup>(28)</sup>	50	43
	F47h	<ul style="list-style-type: none"> <li>• F47 with</li> <li>• absorptive material in cavity</li> <li>• resilient metal channels spaced 600 mm o.c.</li> <li>• 12.7 mm Type X gypsum board</li> </ul>	-	52	46
	<b>F48</b>	<ul style="list-style-type: none"> <li>• one subfloor layer of 11 mm sanded plywood, or OSB or waferboard</li> <li>• one subfloor layer of 15.5 mm plywood, OSB or waferboard, or 17 mm tongue and groove lumber</li> <li>• on steel joists spaced not more than 600 mm o.c.</li> <li>• with or without absorptive material in cavity</li> <li>• resilient metal channels spaced 400 mm or 600 mm o.c.</li> <li>• 2 layers of gypsum board on ceiling side</li> </ul>			
	F48a	<ul style="list-style-type: none"> <li>• F48 with</li> <li>• no absorptive material in cavity</li> <li>• resilient metal channels spaced 400 mm o.c.</li> <li>• 15.9 mm Type X gypsum board</li> </ul>	1 h	48	39
	F48b	<ul style="list-style-type: none"> <li>• F48 with</li> <li>• no absorptive material in cavity</li> <li>• resilient metal channels spaced 600 mm o.c.</li> <li>• 15.9 mm Type X gypsum board</li> </ul>	1 h	50	42
	F48c	<ul style="list-style-type: none"> <li>• F48 with</li> <li>• absorptive material in cavity</li> <li>• resilient metal channels spaced 400 mm o.c.</li> <li>• 15.9 mm Type X gypsum board</li> </ul>	1 h	56	47

	F48d	F48 with <ul style="list-style-type: none"> <li>• absorptive material in cavity</li> <li>• resilient metal channels spaced 600 mm o.c.</li> <li>• 15.9 mm Type X gypsum board</li> </ul>	1 h	57	50
	F48e	F48 with <ul style="list-style-type: none"> <li>• no absorptive material in cavity</li> <li>• resilient metal channels spaced 400 mm o.c.</li> <li>• 12.7 mm Type X gypsum board</li> </ul>	1 h	47	38
	F48f	F48 with <ul style="list-style-type: none"> <li>• no absorptive material in cavity</li> <li>• resilient metal channels spaced 600 mm o.c.</li> <li>• 12.7 mm Type X gypsum board</li> </ul>	-	49	40
	F48g	F48 with <ul style="list-style-type: none"> <li>• absorptive material in cavity</li> <li>• resilient metal channels spaced 400 mm o.c.</li> <li>• 12.7 mm Type X gypsum board</li> </ul>	1 h	54	46
	F48h	F48 with <ul style="list-style-type: none"> <li>• absorptive material in cavity</li> <li>• resilient metal channels spaced 600 mm o.c.</li> <li>• 12.7 mm Type X gypsum board</li> </ul>	-	56	48
	F48i	F48 with <ul style="list-style-type: none"> <li>• no absorptive material in cavity</li> <li>• resilient metal channels spaced 400 mm o.c.</li> <li>• 12.7 mm regular gypsum board</li> </ul>	-	46	37
	F48j	F48 with <ul style="list-style-type: none"> <li>• no absorptive material in cavity</li> <li>• resilient metal channels spaced 600 mm o.c.</li> <li>• 12.7 mm regular gypsum board</li> </ul>	-	48	40
	F48k	F48 with <ul style="list-style-type: none"> <li>• absorptive material in cavity</li> <li>• resilient metal channels spaced 400 mm o.c.</li> <li>• 12.7 mm regular gypsum board</li> </ul>	-	53	45
	F48l	F48 with <ul style="list-style-type: none"> <li>• absorptive material in cavity</li> <li>• resilient metal channels spaced 600 mm o.c.</li> <li>• 12.7 mm regular gypsum board</li> </ul>	-	55	48
	<b>F49</b>	<ul style="list-style-type: none"> <li>• 25 mm gypsum-concrete topping (at least 44 kg/m<sup>2</sup>)</li> <li>• subfloor of 15.5 mm plywood, OSB or waferboard, or 17 mm tongue and groove lumber</li> <li>• on steel joists spaced not more than 600 mm o.c.</li> <li>• with or without absorptive material in cavity</li> </ul>			



		<ul style="list-style-type: none"> <li>• 1 layer of gypsum board on ceiling side</li> </ul>			
	F49a	<ul style="list-style-type: none"> <li>• F49 with</li> <li>• no absorptive material in cavity</li> <li>• 15.9 mm Type X gypsum board</li> </ul>	-	40	13
	F49b	<ul style="list-style-type: none"> <li>• F49 with</li> <li>• absorptive material in cavity</li> <li>• 15.9 mm Type X gypsum board</li> </ul>	-	42	16
	F49c	<ul style="list-style-type: none"> <li>• F49 with</li> <li>• no absorptive material in cavity</li> <li>• 12.7 mm Type X gypsum board</li> </ul>	-	39	12
	F49d	<ul style="list-style-type: none"> <li>• F49 with</li> <li>• absorptive material in cavity</li> <li>• 12.7 mm Type X gypsum board</li> </ul>	-	41	15
	F49e	<ul style="list-style-type: none"> <li>• F49 with</li> <li>• no absorptive material in cavity</li> <li>• 12.7 mm regular gypsum board</li> </ul>	-	38	12
	F49f	<ul style="list-style-type: none"> <li>• F49 with</li> <li>• absorptive material in cavity</li> <li>• 12.7 mm regular gypsum board</li> </ul>	-	40	15
	<b>F50</b>	<ul style="list-style-type: none"> <li>• 25 mm gypsum-concrete topping (at least 44 kg/m<sup>2</sup>)</li> <li>• subfloor of 15.5 mm plywood, OSB or waferboard, or 17 mm tongue and groove lumber</li> <li>• on steel joists spaced not more than 600 mm o.c.</li> <li>• with or without absorptive material in cavity</li> <li>• 2 layers of gypsum board on ceiling side</li> </ul>			
	F50a	<ul style="list-style-type: none"> <li>• F50 with</li> <li>• no absorptive material in cavity</li> <li>• 15.9 mm Type X gypsum board</li> </ul>	-	45	16
	F50b	<ul style="list-style-type: none"> <li>• F50 with</li> <li>• absorptive material in cavity</li> <li>• 15.9 mm Type X gypsum board</li> </ul>	-	47	19
	F50c	<ul style="list-style-type: none"> <li>• F50 with</li> <li>• no absorptive material in cavity</li> <li>• 12.7 mm Type X gypsum board</li> </ul>	-	44	15
	F50d	<ul style="list-style-type: none"> <li>• F50 with</li> <li>• absorptive material in cavity</li> <li>• 12.7 mm Type X gypsum board</li> </ul>	-	46	18
	F50e	<ul style="list-style-type: none"> <li>• F50 with</li> <li>• no absorptive material in cavity</li> <li>• 12.7 mm regular gypsum board</li> </ul>	-	43	14
	F50f	<ul style="list-style-type: none"> <li>• F50 with</li> <li>• absorptive material in cavity</li> <li>• 12.7 mm regular gypsum board</li> </ul>	-	45	17

	<b>F51</b>	<ul style="list-style-type: none"> <li>• 25 mm gypsum-concrete topping (at least 44 kg/m<sup>2</sup>)</li> <li>• subfloor of 15.5 mm plywood, OSB or waferboard, or 17 mm tongue and groove lumber</li> <li>• on steel joists spaced not more than 600 mm o.c.</li> <li>• with or without absorptive material in cavity</li> <li>• resilient metal channels spaced 400 mm or 600 mm o.c.</li> <li>• 1 layer of gypsum board on ceiling side</li> </ul>			
	F51a	<ul style="list-style-type: none"> <li>F51 with</li> <li>• no absorptive material in cavity</li> <li>• resilient metal channels spaced 400 mm o.c.</li> <li>• 15.9 mm Type X gypsum board</li> </ul>	-	52	22
	F51b	<ul style="list-style-type: none"> <li>F51 with</li> <li>• no absorptive material in cavity</li> <li>• resilient metal channels spaced 600 mm o.c.</li> <li>• 15.9 mm Type X gypsum board</li> </ul>	-	54	22
	F51c	<ul style="list-style-type: none"> <li>F51 with</li> <li>• absorptive material in cavity</li> <li>• resilient metal channels spaced 400 mm o.c.</li> <li>• 15.9 mm Type X gypsum board</li> </ul>	-	59	30
	F51d	<ul style="list-style-type: none"> <li>F51 with</li> <li>• absorptive material in cavity</li> <li>• resilient metal channels spaced 600 mm o.c.</li> <li>• 15.9 mm Type X gypsum board</li> </ul>	-	61	30
	F51e	<ul style="list-style-type: none"> <li>F51 with</li> <li>• no absorptive material in cavity</li> <li>• resilient metal channels spaced 400 mm o.c.</li> <li>• 12.7 mm Type X gypsum board</li> </ul>	-	51	21
	F51f	<ul style="list-style-type: none"> <li>F51 with</li> <li>• no absorptive material in cavity</li> <li>• resilient metal channels spaced 600 mm o.c.</li> <li>• 12.7 mm Type X gypsum board</li> </ul>	-	53	21
	F51g	<ul style="list-style-type: none"> <li>F51 with</li> <li>• absorptive material in cavity</li> <li>• resilient metal channels spaced 400 mm o.c.</li> <li>• 12.7 mm Type X gypsum board</li> </ul>	-	58	29
	F51h	<ul style="list-style-type: none"> <li>F51 with</li> <li>• absorptive material in cavity</li> <li>• resilient metal channels spaced 600 mm o.c.</li> <li>• 12.7 mm Type X gypsum board</li> </ul>	-	60	29
	F51i	<ul style="list-style-type: none"> <li>F51 with</li> <li>• no absorptive material in cavity</li> </ul>	-	50	21


		<ul style="list-style-type: none"> <li>• resilient metal channels spaced 400 mm o.c.</li> <li>• 12.7 mm regular gypsum board</li> </ul>			
	F51j	<ul style="list-style-type: none"> <li>• F51 with</li> <li>• no absorptive material in cavity</li> <li>• resilient metal channels spaced 600 mm o.c.</li> <li>• 12.7 mm regular gypsum board</li> </ul>	-	52	21
	F51k	<ul style="list-style-type: none"> <li>• F51 with</li> <li>• absorptive material in cavity</li> <li>• resilient metal channels spaced 400 mm o.c.</li> <li>• 12.7 mm regular gypsum board</li> </ul>	-	57	29
	F51l	<ul style="list-style-type: none"> <li>• F51 with</li> <li>• absorptive material in cavity</li> <li>• resilient metal channels spaced 600 mm o.c.</li> <li>• 12.7 mm regular gypsum board</li> </ul>	-	59	29
	<b>F52</b>	<ul style="list-style-type: none"> <li>• 25 mm gypsum-concrete topping (at least 44 kg/m<sup>2</sup>)</li> <li>• subfloor of 15.5 mm plywood, OSB or waferboard, or 17 mm tongue and groove lumber</li> <li>• on steel joists spaced not more than 600 mm o.c.</li> <li>• with or without absorptive material in cavity</li> <li>• resilient metal channels spaced 400 mm or 600 mm o.c.</li> <li>• 2 layers of gypsum board on ceiling side</li> </ul>			
	F52a	<ul style="list-style-type: none"> <li>• F52 with</li> <li>• no absorptive material in cavity</li> <li>• resilient metal channels spaced 400 mm o.c.</li> <li>• 15.9 mm Type X gypsum board</li> </ul>	1 h	57	25
	F52b	<ul style="list-style-type: none"> <li>• F52 with</li> <li>• no absorptive material in cavity</li> <li>• resilient metal channels spaced 600 mm o.c.</li> <li>• 15.9 mm Type X gypsum board</li> </ul>	1 h	59	25
	F52c	<ul style="list-style-type: none"> <li>• F52 with</li> <li>• absorptive material in cavity</li> <li>• resilient metal channels spaced 400 mm o.c.</li> <li>• 15.9 mm Type X gypsum board</li> </ul>	1 h	64	33
	F52d	<ul style="list-style-type: none"> <li>• F52 with</li> <li>• absorptive material in cavity</li> <li>• resilient metal channels spaced 600 mm o.c.</li> <li>• 15.9 mm Type X gypsum board</li> </ul>	45 min [1 h] <sup>(25)</sup>	66	33
	F52e	<ul style="list-style-type: none"> <li>• F52 with</li> <li>• no absorptive material in cavity</li> <li>• resilient metal channels spaced 400 mm o.c.</li> </ul>	1 h	55	24



		<ul style="list-style-type: none"> <li>• 12.7 mm Type X gypsum board</li> </ul>			
	F52f	F52 with <ul style="list-style-type: none"> <li>• no absorptive material in cavity</li> <li>• resilient metal channels spaced 600 mm o.c.</li> <li>• 12.7 mm Type X gypsum board</li> </ul>	1 h	58	24
	F52g	F52 with <ul style="list-style-type: none"> <li>• absorptive material in cavity</li> <li>• resilient metal channels spaced 400 mm o.c.</li> <li>• 12.7 mm Type X gypsum board</li> </ul>	1 h	62	32
	F52h	F52 with <ul style="list-style-type: none"> <li>• absorptive material in cavity</li> <li>• resilient metal channels spaced 600 mm o.c.</li> <li>• 12.7 mm Type X gypsum board</li> </ul>	45 min [1 h] <sup>(25)</sup>	65	32
	F52i	F52 with <ul style="list-style-type: none"> <li>• no absorptive material in cavity</li> <li>• resilient metal channels spaced 400 mm o.c.</li> <li>• 12.7 mm regular gypsum board</li> </ul>	-	55	23
	F52j	F52 with <ul style="list-style-type: none"> <li>• no absorptive material in cavity</li> <li>• resilient metal channels spaced 600 mm o.c.</li> <li>• 12.7 mm regular gypsum board</li> </ul>	-	57	23
	F52k	F52 with <ul style="list-style-type: none"> <li>• absorptive material in cavity</li> <li>• resilient metal channels spaced 400 mm o.c.</li> <li>• 12.7 mm regular gypsum board</li> </ul>	-	62	31
	F52l	F52 with <ul style="list-style-type: none"> <li>• absorptive material in cavity</li> <li>• resilient metal channels spaced 600 mm o.c.</li> <li>• 12.7 mm regular gypsum board</li> </ul>	-	64	31
	<b>F53</b>	<ul style="list-style-type: none"> <li>• 38 mm concrete topping (at least 70 kg/m<sup>2</sup>)</li> <li>• subfloor of 15.5 mm plywood, OSB or waferboard, or 17 mm tongue and groove lumber</li> <li>• on steel joists spaced not more than 600 mm o.c.</li> <li>• 1 layer of gypsum board on ceiling side</li> </ul>			
	F53a	F53 with <ul style="list-style-type: none"> <li>• no absorptive material in cavity</li> <li>• 15.9 mm Type X gypsum board</li> </ul>	-	44	22
	F53b	F53 with <ul style="list-style-type: none"> <li>• absorptive material in cavity</li> <li>• 15.9 mm Type X gypsum board</li> </ul>	-	46	25
	F53c	F53 with <ul style="list-style-type: none"> <li>• no absorptive material in cavity</li> </ul>	-	42	21





		<ul style="list-style-type: none"> <li>• 12.7 mm Type X gypsum board</li> </ul>			
	F53d	<ul style="list-style-type: none"> <li>• F53 with</li> <li>• absorptive material in cavity</li> <li>• 12.7 mm Type X gypsum board</li> </ul>	-	44	24
	F53e	<ul style="list-style-type: none"> <li>• F53 with</li> <li>• no absorptive material in cavity</li> <li>• 12.7 mm regular gypsum board</li> </ul>	-	42	21
	F53f	<ul style="list-style-type: none"> <li>• F53 with</li> <li>• absorptive material in cavity</li> <li>• 12.7 mm regular gypsum board</li> </ul>	-	44	24
	<b>F54</b>	<ul style="list-style-type: none"> <li>• 38 mm concrete topping (at least 70 kg/m<sup>2</sup>)</li> <li>• subfloor of 15.5 mm plywood, OSB or waferboard, or 17 mm tongue and groove lumber</li> <li>• on steel joists spaced not more than 600 mm o.c.</li> <li>• 2 layers of gypsum board on ceiling side</li> </ul>			
	F54a	<ul style="list-style-type: none"> <li>• F54 with</li> <li>• no absorptive material in cavity</li> <li>• 15.9 mm Type X gypsum board</li> </ul>	-	48	24
	F54b	<ul style="list-style-type: none"> <li>• F54 with</li> <li>• absorptive material in cavity</li> <li>• 15.9 mm Type X gypsum board</li> </ul>	-	50	27
	F54c	<ul style="list-style-type: none"> <li>• F54 with</li> <li>• no absorptive material in cavity</li> <li>• 12.7 mm Type X gypsum board</li> </ul>	-	47	23
	F54d	<ul style="list-style-type: none"> <li>• F54 with</li> <li>• absorptive material in cavity</li> <li>• 12.7 mm Type X gypsum board</li> </ul>	-	49	26
	F54e	<ul style="list-style-type: none"> <li>• F54 with</li> <li>• no absorptive material in cavity</li> <li>• 12.7 mm regular gypsum board</li> </ul>	-	47	23
	F54f	<ul style="list-style-type: none"> <li>• F54 with</li> <li>• absorptive material in cavity</li> <li>• 12.7 mm regular gypsum board</li> </ul>	-	49	26
	<b>F55</b>	<ul style="list-style-type: none"> <li>• 38 mm concrete topping (at least 70 kg/m<sup>2</sup>)</li> <li>• subfloor of 15.5 mm plywood, OSB or waferboard, or 17 mm tongue and groove lumber</li> <li>• on steel joists spaced not more than 600 mm o.c.</li> <li>• with or without absorptive material in cavity</li> <li>• resilient metal channels spaced 400 mm or 600 mm o.c.</li> <li>• 1 layer of gypsum board on ceiling side</li> </ul>			
	F55a	<ul style="list-style-type: none"> <li>• F55 with</li> <li>• no absorptive material in cavity</li> </ul>	-	56	31

		<ul style="list-style-type: none"> <li>• resilient metal channels spaced 400 mm o.c.</li> <li>• 15.9 mm Type X gypsum board</li> </ul>			
	F55b	<ul style="list-style-type: none"> <li>• F55 with</li> <li>• no absorptive material in cavity</li> <li>• resilient metal channels spaced 600 mm o.c.</li> <li>• 15.9 mm Type X gypsum board</li> </ul>	-	58	31
	F55c	<ul style="list-style-type: none"> <li>• F55 with</li> <li>• absorptive material in cavity</li> <li>• resilient metal channels spaced 400 mm o.c.</li> <li>• 15.9 mm Type X gypsum board</li> </ul>	-	63	39
	F55d	<ul style="list-style-type: none"> <li>• F55 with</li> <li>• absorptive material in cavity</li> <li>• resilient metal channels spaced 600 mm o.c.</li> <li>• 15.9 mm Type X gypsum board</li> </ul>	-	65	39
	F55e	<ul style="list-style-type: none"> <li>• F55 with</li> <li>• no absorptive material in cavity</li> <li>• resilient metal channels spaced 400 mm o.c.</li> <li>• 12.7 mm Type X gypsum board</li> </ul>	-	54	30
	F55f	<ul style="list-style-type: none"> <li>• F55 with</li> <li>• no absorptive material in cavity</li> <li>• resilient metal channels spaced 600 mm o.c.</li> <li>• 12.7 mm Type X gypsum board</li> </ul>	-	56	30
	F55g	<ul style="list-style-type: none"> <li>• F55 with</li> <li>• absorptive material in cavity</li> <li>• resilient metal channels spaced 400 mm o.c.</li> <li>• 12.7 mm Type X gypsum board</li> </ul>	-	61	38
	F55h	<ul style="list-style-type: none"> <li>• F55 with</li> <li>• absorptive material in cavity</li> <li>• resilient metal channels spaced 600 mm o.c.</li> <li>• 12.7 mm Type X gypsum board</li> </ul>	-	63	38
	F55i	<ul style="list-style-type: none"> <li>• F55 with</li> <li>• no absorptive material in cavity</li> <li>• resilient metal channels spaced 400 mm o.c.</li> <li>• 12.7 mm regular gypsum board</li> </ul>	-	54	30
	F55j	<ul style="list-style-type: none"> <li>• F55 with</li> <li>• no absorptive material in cavity</li> <li>• resilient metal channels spaced 600 mm o.c.</li> <li>• 12.7 mm regular gypsum board</li> </ul>	-	56	30
	F55k	<ul style="list-style-type: none"> <li>• F55 with</li> <li>• absorptive material in cavity</li> <li>• resilient metal channels spaced 400 mm o.c.</li> <li>• 12.7 mm regular gypsum board</li> </ul>	-	61	38


	F55l	<ul style="list-style-type: none"> <li>F55 with</li> <li>• absorptive material in cavity</li> <li>• resilient metal channels spaced 600 mm o.c.</li> <li>• 12.7 mm regular gypsum board</li> </ul>	-	63	38
	<b>F56</b>	<ul style="list-style-type: none"> <li>• 38 mm concrete topping (at least 70 kg/m<sup>2</sup>)</li> <li>• subfloor of 15.5 mm plywood, OSB or waferboard, or 17 mm tongue and groove lumber</li> <li>• on steel joists spaced not more than 600 mm o.c.</li> <li>• with or without absorptive material in cavity</li> <li>• resilient metal channels spaced 400 mm or 600 mm o.c.</li> <li>• 2 layers of gypsum board on ceiling side</li> </ul>			
	F56a	<ul style="list-style-type: none"> <li>F56 with</li> <li>• no absorptive material in cavity</li> <li>• resilient metal channels spaced 400 mm o.c.</li> <li>• 15.9 mm Type X gypsum board</li> </ul>	1 h	60	33
	F56b	<ul style="list-style-type: none"> <li>F56 with</li> <li>• no absorptive material in cavity</li> <li>• resilient metal channels spaced 600 mm o.c.</li> <li>• 15.9 mm Type X gypsum board</li> </ul>	1 h	62	33
	F56c	<ul style="list-style-type: none"> <li>F56 with</li> <li>• absorptive material in cavity</li> <li>• resilient metal channels spaced 400 mm o.c.</li> <li>• 15.9 mm Type X gypsum board</li> </ul>	1 h	67	41
	F56d	<ul style="list-style-type: none"> <li>F56 with</li> <li>• absorptive material in cavity</li> <li>• resilient metal channels spaced 600 mm o.c.</li> <li>• 15.9 mm Type X gypsum board</li> </ul>	45 min [1 h] <sup>(25)</sup>	69	41
	F56e	<ul style="list-style-type: none"> <li>F56 with</li> <li>• no absorptive material in cavity</li> <li>• resilient metal channels spaced 400 mm o.c.</li> <li>• 12.7 mm Type X gypsum board</li> </ul>	1 h	59	32
	F56f	<ul style="list-style-type: none"> <li>F56 with</li> <li>• no absorptive material in cavity</li> <li>• resilient metal channels spaced 600 mm o.c.</li> <li>• 12.7 mm Type X gypsum board</li> </ul>	1 h	61	32
	F56g	<ul style="list-style-type: none"> <li>F56 with</li> <li>• absorptive material in cavity</li> <li>• resilient metal channels spaced 400 mm o.c.</li> <li>• 12.7 mm Type X gypsum board</li> </ul>	1 h	66	40
	F56h	<ul style="list-style-type: none"> <li>F56 with</li> <li>• absorptive material in cavity</li> </ul>	45 min [1 h] <sup>(25)</sup>	68	40

		<ul style="list-style-type: none"> <li>• resilient metal channels spaced 600 mm o.c.</li> <li>• 12.7 mm Type X gypsum board</li> </ul>			
	F56i	<ul style="list-style-type: none"> <li>• F56 with</li> <li>• no absorptive material in cavity</li> <li>• resilient metal channels spaced 400 mm o.c.</li> <li>• 12.7 mm regular gypsum board</li> </ul>	-	58	32
	F56j	<ul style="list-style-type: none"> <li>• F56 with</li> <li>• no absorptive material in cavity</li> <li>• resilient metal channels spaced 600 mm o.c.</li> <li>• 12.7 mm regular gypsum board</li> </ul>	-	61	32
	F56k	<ul style="list-style-type: none"> <li>• F56 with</li> <li>• absorptive material in cavity</li> <li>• resilient metal channels spaced 400 mm o.c.</li> <li>• 12.7 mm regular gypsum board</li> </ul>	-	65	40
	F56l	<ul style="list-style-type: none"> <li>• F56 with</li> <li>• absorptive material in cavity</li> <li>• resilient metal channels spaced 600 mm o.c.</li> <li>• 12.7 mm regular gypsum board</li> </ul>	-	68	40
	<b>F57</b>	<ul style="list-style-type: none"> <li>• 50 mm concrete</li> <li>• 0.46 mm metal pan with 19 mm rib</li> <li>• on steel joists spaced not more than 600 mm o.c.</li> <li>• 1 layer of gypsum board on ceiling side</li> </ul>			
	F57a	<ul style="list-style-type: none"> <li>• F57 with</li> <li>• no absorptive material in cavity</li> <li>• 15.9 mm Type X gypsum board</li> </ul>	-	45	26
	F57b	<ul style="list-style-type: none"> <li>• F57 with</li> <li>• absorptive material in cavity</li> <li>• 15.9 mm Type X gypsum board</li> </ul>	-	47	29
	F57c	<ul style="list-style-type: none"> <li>• F57 with</li> <li>• no absorptive material in cavity</li> <li>• 12.7 mm Type X gypsum board</li> </ul>	-	44	25
	F57d	<ul style="list-style-type: none"> <li>• F57 with</li> <li>• absorptive material in cavity</li> <li>• 12.7 mm Type X gypsum board</li> </ul>	-	46	28
	F57e	<ul style="list-style-type: none"> <li>• F57 with</li> <li>• no absorptive material in cavity</li> <li>• 12.7 mm regular gypsum board</li> </ul>	-	43	25
	F57f	<ul style="list-style-type: none"> <li>• F57 with</li> <li>• absorptive material in cavity</li> <li>• 12.7 mm regular gypsum board</li> </ul>	-	45	28
	<b>F58</b>	<ul style="list-style-type: none"> <li>• 50 mm concrete</li> <li>• 0.38 mm metal pan with 16 mm rib</li> <li>• on steel joists spaced not more than 600 mm o.c.</li> <li>• 2 layers of gypsum board on ceiling side</li> </ul>			

	F58a	F58 with • no absorptive material in cavity • 15.9 mm Type X gypsum board	-	50	27
	F58b	F58 with • absorptive material in cavity • 15.9 mm Type X gypsum board	-	52	30
	F58c	F58 with • no absorptive material in cavity • 12.7 mm Type X gypsum board	-	48	27
	F58d	F58 with • absorptive material in cavity • 12.7 mm Type X gypsum board	-	50	30
	F58e	F58 with • no absorptive material in cavity • 12.7 mm regular gypsum board	-	48	27
	F58f	F58 with • absorptive material in cavity • 12.7 mm regular gypsum board	-	50	30
	<b>F59</b>	<ul style="list-style-type: none"> <li>• 50 mm concrete</li> <li>• 0.38 mm metal pan with 16 mm rib</li> <li>• on steel joists spaced not more than 600 mm o.c.</li> <li>• with or without absorptive material in cavity</li> <li>• resilient metal channels spaced 400 mm or 600 mm o.c.</li> <li>• 1 layer of gypsum board on ceiling side</li> </ul>			
	F59a	F59 with • no absorptive material in cavity • resilient metal channels spaced 400 mm o.c. • 15.9 mm Type X gypsum board	-	57	35
	F59b	F59 with • no absorptive material in cavity • resilient metal channels spaced 600 mm o.c. • 15.9 mm Type X gypsum board	-	59	35
	F59c	F59 with • absorptive material in cavity • resilient metal channels spaced 400 mm o.c. • 15.9 mm Type X gypsum board	-	64	43
	F59d	F59 with • absorptive material in cavity • resilient metal channels spaced 600 mm o.c. • 15.9 mm Type X gypsum board	-	66	43
	F59e	F59 with • no absorptive material in cavity • resilient metal channels spaced 400 mm o.c. • 12.7 mm Type X gypsum board	-	56	34

	F59f	F59 with • no absorptive material in cavity • resilient metal channels spaced 600 mm o.c. • 12.7 mm Type X gypsum board	-	56	34
	F59g	F59 with • absorptive material in cavity • resilient metal channels spaced 400 mm o.c. • 12.7 mm Type X gypsum board	-	63	42
	F59h	F59 with • absorptive material in cavity • resilient metal channels spaced 600 mm o.c. • 12.7 mm Type X gypsum board	-	65	42
	F59i	F59 with • no absorptive material in cavity • resilient metal channels spaced 400 mm o.c. • 12.7 mm regular gypsum board	-	55	34
	F59j	F59 with • no absorptive material in cavity • resilient metal channels spaced 600 mm o.c. • 12.7 mm regular gypsum board	-	57	34
	F59k	F59 with • absorptive material in cavity • resilient metal channels spaced 400 mm o.c. • 12.7 mm regular gypsum board	-	62	42
	F59l	F59 with • absorptive material in cavity • resilient metal channels spaced 600 mm o.c. • 12.7 mm regular gypsum board	-	64	42
	<b>F60</b>	<ul style="list-style-type: none"> <li>• 50 mm concrete</li> <li>• 0.46 mm metal pan with a 19 mm rib</li> <li>• on steel joists spaced not more than 600 mm o.c.</li> <li>• with or without absorptive material in cavity</li> <li>• resilient metal channels spaced 400 mm or 600 mm o.c.</li> <li>• 2 layers of gypsum board on ceiling side</li> </ul>			
	F60a	F60 with • no absorptive material in cavity • resilient metal channels spaced 400 mm o.c. • 15.9 mm Type X gypsum board	1 h	62	36
	F60b	F60 with • no absorptive material in cavity • resilient metal channels spaced 600 mm o.c. • 15.9 mm Type X gypsum board	1 h	64	36

	F60c	F60 with • absorptive material in cavity • resilient metal channels spaced 400 mm o.c. • 15.9 mm Type X gypsum board	1 h	69	44
	F60d	F60 with • absorptive material in cavity • resilient metal channels spaced 600 mm o.c. • 15.9 mm Type X gypsum board	45 min [1 h] <sup>(25)</sup>	71	44
	F60e	F60 with • no absorptive material in cavity • resilient metal channels spaced 400 mm o.c. • 12.7 mm Type X gypsum board	1h	60	36
	F60f	F60 with • no absorptive material in cavity • resilient metal channels spaced 600 mm o.c. • 12.7 mm Type X gypsum board	1 h	62	36
	F60g	F60 with • absorptive material in cavity • resilient metal channels spaced 400 mm o.c. • 12.7 mm Type X gypsum board	1 h	67	44
	F60h	F60 with • absorptive material in cavity • resilient metal channels spaced 600 mm o.c. • 12.7 mm Type X gypsum board	45 min [1 h] <sup>(25)</sup>	69	44
	F60i	F60 with • no absorptive material in cavity • resilient metal channels spaced 400 mm o.c. • 12.7 mm regular gypsum board	-	60	36
	F60j	F60 with • no absorptive material in cavity • resilient metal channels spaced 600 mm o.c. • 12.7 mm regular gypsum board	-	62	36
	F60k	F60 with • absorptive material in cavity • resilient metal channels spaced 400 mm o.c. • 12.7 mm regular gypsum board	-	67	44
	F60l	F60 with • absorptive material in cavity • resilient metal channels spaced 600 mm o.c. • 12.7 mm regular gypsum board	-	69	44

	<b>F61</b>	<ul style="list-style-type: none"> <li>• 50 mm concrete</li> <li>• 0.38 mm metal pan with 16 mm rib</li> <li>• on steel joists spaced not more than 600 mm o.c.</li> <li>• with or without absorptive material in cavity</li> <li>• resilient metal channels spaced 400 mm or 600 mm o.c.</li> <li>• 2 layers of gypsum board on ceiling side</li> </ul>			
	F61a	<ul style="list-style-type: none"> <li>• F61 with</li> <li>• no absorptive material in cavity</li> <li>• resilient metal channels spaced 400 mm o.c.</li> <li>• 15.9 mm Type X gypsum board</li> </ul>	1 h	62	32
	F61b	<ul style="list-style-type: none"> <li>• F61 with</li> <li>• steel joists spaced 400 mm o.c.</li> <li>• no absorptive material in cavity</li> <li>• resilient metal channels spaced 600 mm o.c.</li> <li>• 15.9 mm Type X gypsum board</li> </ul>	1 h	64	32
	F61c	<ul style="list-style-type: none"> <li>• F61 with</li> <li>• steel joists spaced 600 mm o.c.</li> <li>• no absorptive material in cavity</li> <li>• resilient metal channels spaced 600 mm o.c.</li> <li>• 15.9 mm Type X gypsum board</li> </ul>	-	65	29
	F61d	<ul style="list-style-type: none"> <li>• F61 with</li> <li>• absorptive material in cavity</li> <li>• resilient metal channels spaced 400 mm o.c.</li> <li>• 15.9 mm Type X gypsum board</li> </ul>	1 h	68	37
	F61e	<ul style="list-style-type: none"> <li>• F61 with</li> <li>• steel joists spaced 400 mm o.c.</li> <li>• absorptive material in cavity</li> <li>• resilient metal channels spaced 600 mm o.c.</li> <li>• 15.9 mm Type X gypsum board</li> </ul>	1h	66	34
	F61f	<ul style="list-style-type: none"> <li>• F61 with</li> <li>• steel joists spaced 600 mm o.c.</li> <li>• absorptive material in cavity</li> <li>• resilient metal channels spaced 600 mm o.c.</li> <li>• 15.9 mm Type X gypsum board</li> </ul>	-	71	34
	F61g	<ul style="list-style-type: none"> <li>• F61 with</li> <li>• no absorptive material in cavity</li> <li>• resilient metal channels spaced 400 mm o.c.</li> <li>• 12.7 mm Type X gypsum board</li> </ul>	1 h	62	32
	F61h	<ul style="list-style-type: none"> <li>• F61 with</li> <li>• steel joists spaced 400 mm o.c.</li> <li>• no absorptive material in cavity</li> <li>• resilient metal channels spaced 600 mm o.c.</li> <li>• 12.7 mm Type X gypsum board</li> </ul>	1 h	64	32



	F61i	F61 with • steel joists spaced 600 mm o.c. • no absorptive material in cavity • resilient metal channels spaced 600 mm o.c. • 12.7 mm Type X gypsum board	-	64	28
	F61j	F61 with • absorptive material in cavity • resilient metal channels spaced 400 mm o.c. • 12.7 mm Type X gypsum board	1 h	68	36
	F61k	F61 with • steel joists spaced 400 mm o.c. • absorptive material in cavity • resilient metal channels spaced 600 mm o.c. • 12.7 mm Type X gypsum board	1 h	64	32
	F61l	F61 with • steel joists spaced 600 mm o.c. • no absorptive material in cavity • resilient metal channels spaced 600 mm o.c. • 12.7 mm Type X gypsum board	-	70	34
Roofs					
Wood Roof Trusses	R1	• wood trusses spaced not more than 600 mm o.c. • 1 layer 15.9 mm Type X gypsum board	45 min	-	-
Rating Provided by Membrane Only					
	M1	• supporting members spaced not more than 600 mm o.c. • 1 layer 15.9 mm Type X gypsum board	30 min	-	-
	M2	• supporting members spaced not more than 600 mm o.c. • 2 layers 15.9 mm Type X gypsum board	1 h	-	-

**Notes to Table 9.10.3.1.-B:**

<sup>(1)</sup> See Note A-9.10.3.1.

<sup>(2)</sup> For assemblies with a ceiling consisting of a single layer of gypsum board on resilient metal channels to obtain the listed ratings, the resilient metal channel arrangement at the gypsum board butt end joints should be as shown in Figure A-9.10.3.1.-A.

<sup>(3)</sup> For assemblies with a ceiling consisting of 2 layers of gypsum board on resilient metal channels to obtain the listed ratings, the fastener and resilient metal channel arrangement at the gypsum board butt end joints should be as shown in Figure A-9.10.3.1.-B.

<sup>(4)</sup> The *fire-resistance rating* and *sound transmission class* values given are for a minimum thickness of subfloor or deck as shown. Minimum subfloor thickness required is determined by structural member spacing (see Table 9.23.15.5.-A). Thicker subflooring or decking is also acceptable.

<sup>(5)</sup> Sound absorptive material includes

- (i) fibre processed from rock, slag, or glass, and
- (ii) loose-fill or spray-applied cellulose fibre.

To obtain the listed *sound transmission class* rating, the nominal insulation thickness is 150 mm for rock, slag, or glass fibres or loose-fill cellulose fibre, and 90 mm for spray-applied cellulose fibre, unless otherwise specified. Absorptive material will affect the *sound transmission class* by approximately adding or subtracting 1 per 50 mm change of thickness. However, no additional *sound transmission class* value is achieved by adding a greater thickness of insulation than the depth of the assembly.

- <sup>(6)</sup> The *fire-resistance rating* and *sound transmission class* values are based on the spacing of ceiling supports as noted. (See also Table Note (10).) A narrower spacing will be detrimental to the *sound transmission class* rating, but not to the *fire-resistance rating*.
- <sup>(7)</sup> To obtain the listed rating, fastener type, spacing and penetration depth for the attachment of gypsum board must conform to Subsection 9.29.5., and
- (i) fastener distance to board edges and butt ends should be not less than 38 mm, except for fasteners on the butt ends of the base layer in ceilings with two layers (see Figure A-9.10.3.1.-B),
  - (ii) fasteners are spaced not more than 300 mm o.c.,
  - (iii) fasteners must consist of nails or screws when attaching gypsum board to wood members, and
  - (iv) fasteners must consist of screws when attaching gypsum board to cold-formed steel channels or resilient metal channels.
- For wood- and steel-framed assemblies, if fasteners are spaced less than 300 mm o.c., subtract 1 from the *sound transmission class* value; if fasteners are spaced less than 200 mm o.c., subtract 2 from the *sound transmission class* value. Narrower fastener spacing is not detrimental to the *fire-resistance rating*.
- <sup>(8)</sup> See Sentence D-1.2.1.(2) of Appendix D for the significance of *fire-resistance ratings*.
- <sup>(9)</sup> The *sound transmission class* values given in the Table are for the minimum depth of structural member noted in the description and applicable table notes. To obtain *sound transmission class* values for structural members deeper than that minimum, add 1 to the *sound transmission class* value in the Table for each 170 mm increase in structural member depth.
- <sup>(10)</sup> The *sound transmission class* values given in the Table are for structural member spacing of 300 mm o.c., unless otherwise noted in the description and applicable table notes. To obtain *sound transmission class* values for assemblies with structural members spaced more than 500 mm o.c., add 1 to the *sound transmission class* value in the Table.
- <sup>(11)</sup> Assemblies with sound transmission class ratings of 50 or more require methods to minimize airborne sound transmission at electrical boxes and other openings, and at wall/wall and wall/floor junctions, except at junctions constructed of concrete-to-concrete, concrete-to-masonry, or masonry-to-masonry where the intersecting joint along the junction is cast or mortared.
- <sup>(12)</sup> The impact insulation class values given are for floor assemblies tested with no finished flooring.
- <sup>(13)</sup> Wood floor joists are:
- (i) wood joists with a minimum member size of 38 mm (width) × 235 mm (depth), except as otherwise noted (see Table Note (16)); or
  - (ii) wood I-joists with a minimum flange size of 38 mm × 38 mm, a minimum OSB or plywood web thickness of 9.5 mm, and a minimum joist depth of 241 mm.
- <sup>(14)</sup> Except where assemblies with wood I-joists are tested according to CAN/ULC-S101 the *fire-resistance rating* values apply only to I-joists that have been fabricated with a phenolic-based structural wood adhesive complying with CSA O112.10. For I-joists with flanges made of laminated veneer lumber (LVL), the *fire-resistance rating* values apply only where the adhesive used in the LVL fabrication is a phenolic-based structural wood adhesive complying with CSA O112.9.
- <sup>(15)</sup> The *fire-resistance rating* value within square brackets is achieved only where absorptive material includes spray-applied cellulose fibre with
- (i) adhesive that is capable of providing a minimum cohesive/adhesive bond strength per unit area of 5 times the weight of the material under the test plate when tested in accordance with ASTM E736/E736M,
  - (ii) a minimum density of 35 kg/m<sup>3</sup>, and
  - (iii) a minimum thickness of 90 mm on the underside of the subfloor or deck, of 90 mm on the sides of the structural members, and for cold-formed steel joists, of 13 mm on the underside of the bottom flange other than at resilient metal channel locations.
- <sup>(16)</sup> The *fire-resistance rating* value within square brackets only applies to assemblies with solid wood joists and is achieved only where absorptive material includes:
- (i) fibre processed from rock or slag with a minimum thickness of 90 mm and a minimum surface area mass of 2.8 kg/m<sup>2</sup>; or
  - (ii) spray-applied cellulose fibre with a minimum density of 50 kg/m<sup>3</sup> and a minimum depth of 90 mm on the underside of the subfloor and of 90 mm on the sides of the floor joists.
- <sup>(17)</sup> The *fire-resistance rating*, *sound transmission class* and impact insulation class values given are also applicable to assemblies with 38 mm (width) × 184 mm (depth) solid wood joists.
- <sup>(18)</sup> The *fire-resistance rating* value within square brackets is achieved only where absorptive material includes:

- (i) fibre processed from rock or slag with a minimum thickness of 90 mm and a minimum surface area mass of 2.8 kg/m<sup>2</sup>; or
- (ii) spray-applied cellulose fibre with a minimum density of 50 kg/m<sup>3</sup> and a minimum depth of 90 mm on the underside of the subfloor and of 90 mm on the webs or the sides of the structural members.

<sup>(19)</sup> The *fire-resistance rating*, *sound transmission class* and impact insulation class values within the square brackets only apply to assemblies with solid wood joists and are achieved only where absorptive material includes dry-blown cellulose fibre with a minimum density of 40 kg/m<sup>3</sup> filling the entire cavity; the cellulose fibre is supported on zinc-coated (galvanized) steel poultry fence fabric conforming to ASTM A390, which has 25-mm-wide hexagonal mesh openings and 0.81-mm-thick (20-gauge) wire and is attached to wood joists with metal staples having legs that are 50 mm long.

<sup>(20)</sup> The *fire-resistance rating* and *sound transmission class* values are achieved only where absorptive material includes:

- (i) fibre processed from rock or slag that fills the joist cavity and has a minimum surface area mass of 2.8 kg/m<sup>2</sup>, and for structural members at least 270 mm in depth, the fibre includes three layers each of which has a minimum thickness of 90 mm; or
- (ii) dry-blown cellulose fibre with a minimum density of 40 kg/m<sup>3</sup> filling the entire cavity; the cellulose fibre is supported on zinc-coated (galvanized) steel poultry fence fabric conforming to ASTM A390, which has 25-mm-wide hexagonal mesh openings and 0.81-mm-thick (20-gauge) wire and is attached to wood joists or wood I-joists with metal staples having legs that are 50 mm or 30 mm long, respectively.

<sup>(21)</sup> The *fire-resistance rating* value only applies to assemblies with wood I-joists with flanges with a minimum thickness of 38 mm and a minimum width of 63 mm.

<sup>(22)</sup> The *fire-resistance rating* and *sound transmission class* values are achieved only where absorptive material includes:

- (i) fibre processed from rock or slag that fills the joist cavity and has a minimum surface area mass of 2.8 kg/m<sup>2</sup>, and for structural members at least 270 mm in depth, the fibre includes three layers each of which has a minimum thickness of 90 mm; or
- (ii) dry-blown cellulose fibre with a minimum density of 40 kg/m<sup>3</sup> filling the entire cavity; the cellulose fibre is supported on zinc-coated (galvanized) steel poultry fence fabric conforming to ASTM A390, which has 25-mm-wide hexagonal mesh openings and 0.81-mm-thick (20-gauge) wire and is attached to wood joists with metal staples having legs that are 50 mm long.

<sup>(23)</sup> The *fire-resistance rating* values given only apply to assemblies with solid wood joists spaced not more than 400 mm o.c. No information is available for assemblies constructed with wood I-joists.

<sup>(24)</sup> Wood floor trusses are:

- (i) metal-plate-connected wood trusses with wood framing members not less than 38 mm × 64 mm, metal connector plates not less than 1 mm (nominal) thick with teeth not less than 8 mm long, and a minimum truss depth of 305 mm;
- (ii) metal-web wood trusses with wood chords not less than 38 mm × 64 mm, V-shaped webs made from galvanized steel of 1 mm (nominal) thickness with plate areas having teeth not less than 8 mm long, and a minimum truss depth of 286 mm; or
- (iii) fingerjoined wood trusses with glued fingerjoined connections, chord members not less than 38 mm × 64 mm, web members not less than 38 mm × 38 mm and a minimum truss depth of 330 mm, all of which is glued together with an R-14 phenol-resorcinol resin conforming to CSA O112.10.

<sup>(25)</sup> The *fire-resistance rating* value within square brackets is achieved only where absorptive material includes fibre processed from rock or slag with a minimum thickness of 90 mm and a minimum surface area mass of 2.8 kg/m<sup>2</sup>.

<sup>(26)</sup> The *fire-resistance rating* and *sound transmission class* values within square brackets are achieved only where absorptive material includes dry-blown cellulose fibre with a minimum density of 40 kg/m<sup>3</sup> filling the entire cavity; the cellulose fibre is supported on zinc-coated (galvanized) steel poultry fence fabric conforming to ASTM A390, which has 25-mm-wide hexagonal mesh openings and 0.81-mm-thick (20-gauge) wire and is attached to wood trusses with metal staples having legs that are 38 mm long.

<sup>(27)</sup> Cold-formed steel floor joists (C-shaped joists) are members with a minimum size of 41 mm (width) × 203 mm (depth) × 1.22 mm (material thickness).

<sup>(28)</sup> The *fire-resistance rating* value within square brackets is achieved only where absorptive material includes spray-applied cellulose fibre with a minimum density of 50 kg/m<sup>3</sup> and a minimum thickness of 90 mm on the underside of the subfloor, of 90 mm on the sides of the cold-formed steel floor joists, and of 13 mm on the underside of the bottom flange other than at resilient metal channel locations.

# Span Tables

**Table 9.20.17.4.-A**

**Maximum Allowable Clear Spans for Lintels in Flat Loadbearing Insulating Concrete Form (ICF) Walls(1)(2)(3) (1-10M Bottom Bar)**

**Forming Part of Sentences 9.3.2.8.(1) and 9.20.17.4.(3)**

Minimum Lintel Thickness, mm	Minimum Lintel Depth, mm	Maximum Clear Span, m			
		Supporting Light-Frame Roof Only		Supporting ICF Second Storey and Light-Frame Roof	
		Maximum Ground Snow Load, kN/m <sup>2</sup>			
		1.50	3.33	1.50	3.33
140	200	1.41	1.18	1.03	0.93
	300	1.78	1.50	1.30	1.18
	400	2.08	1.75	1.53	1.38
	500	2.33	1.97	1.72	1.56
	600	2.55	2.16	1.89	1.71
150	200	1.41	1.18	1.02	0.92
	300	1.78	1.50	1.29	1.17
	400	2.08	1.75	1.51	1.37
	500	2.33	1.97	1.70	1.54
	600	2.54	2.15	1.87	1.70
160	200	1.41	1.18	1.01	0.91
	300	1.78	1.50	1.28	1.16
	400	2.07	1.75	1.50	1.36
	500	2.32	1.96	1.68	1.53
	600	2.53	2.15	1.85	1.68
190	200	1.41	1.19	0.98	0.89
	300	1.78	1.50	1.24	1.13
	400	2.06	1.74	1.45	1.32
	500	2.30	1.95	1.63	1.49
	600	2.51	2.13	1.78	1.63
200	200	1.41	1.19	0.97	0.89
	300	1.77	1.49	1.23	1.12
	400	2.06	1.74	1.43	1.31
	500	2.30	1.95	1.61	1.48
	600	2.50	2.13	1.77	1.62

240	200	1.41	1.19	0.94	0.86
	300	1.76	1.49	1.18	1.09
	400	2.04	1.73	1.38	1.27
	500	2.27	1.93	1.55	1.43
	600	2.47	2.11	1.70	1.56

**Notes to Table 9.20.17.4.-A:**

- (1) Deflection criterion is  $L/240$ , where "L" is the clear span of the lintel.  
(2) Linear interpolation is permitted between ground snow loads and between lintel depths.  
(3) 10M stirrups are required at a maximum  $d/2$  spacing for spans greater than 1 200 mm, where "d" is the distance from the top of the lintel to the level of the bottom reinforcing bar in the lintel.

**Table 9.20.17.4.-B**

**Maximum Allowable Clear Spans for Lintels in Flat Loadbearing Insulating Concrete Form (ICF) Walls(1)(2)(3) (1-15M Bottom Bar)**

**Forming Part of Sentences 9.3.2.8.(1) and 9.20.17.4.(3)**

Minimum Lintel Thickness, mm	Minimum Lintel Depth, mm	Maximum Clear Span, m			
		Supporting Light-Frame Roof Only		Supporting ICF Second Storey and Light-Frame Roof	
		Maximum Ground Snow Load, kN/m <sup>2</sup>			
		1.50	3.33	1.50	3.33
140	200	1.63	1.46	1.31	1.23
	300	2.43	2.08	1.81	1.64
	400	2.90	2.44	2.13	1.93
	500	3.26	2.75	2.41	2.18
	600	3.58	3.03	2.65	2.4
150	200	1.67	1.49	1.33	1.25
	300	2.48	2.08	1.79	1.62
	400	2.90	2.44	2.11	1.91
	500	3.26	2.75	2.38	2.16
	600	3.57	3.02	2.62	2.38
160	200	1.70	1.53	1.35	1.26
	300	2.48	2.08	1.78	1.61
	400	2.90	2.44	2.09	1.90
	500	3.25	2.75	2.36	2.14
	600	3.56	3.02	2.59	2.36
190	200	1.80	1.61	1.36	1.24
	300	2.48	2.09	1.73	1.58
	400	2.89	2.44	2.03	1.85
	500	3.23	2.74	2.29	2.09

	600	3.53	3.00	2.51	2.30
200	200	1.83	1.64	1.35	1.23
	300	2.48	2.09	1.71	1.57
	400	2.88	2.44	2.01	1.84
	500	3.22	2.74	2.26	2.07
	600	3.52	2.99	2.48	2.28
240	200	1.93	1.65	1.30	1.20
	300	2.47	2.08	1.66	1.52
	400	2.86	2.43	1.94	1.78
	500	3.19	2.72	2.18	2.01
	600	3.47	2.97	2.39	2.20

**Notes to Table 9.20.17.4.-B:**

- (1) Deflection criterion is  $L/240$ , where "L" is the clear span of the lintel.  
(2) Linear interpolation is permitted between ground snow loads and between lintel depths.  
(3) 10M stirrups are required at a maximum  $d/2$  spacing for spans greater than 1 200 mm, where "d" is the distance from the top of the lintel to the level of the bottom reinforcing bar in the lintel.

**Table 9.20.17.4.-C**

**Maximum Allowable Clear Spans for Lintels in Flat Loadbearing Insulating Concrete Form (ICF) Walls(1)(2)(3) (2-15M Bottom Bar)**

**Forming Part of Sentences 9.3.2.8.(1) and 9.20.17.4.(3)**

Minimum Lintel Thickness, mm	Minimum Lintel Depth, mm	Maximum Clear Span, m			
		Supporting Light-Frame Roof Only		Supporting ICF Second Storey and Light-Frame Roof	
		Maximum Ground Snow Load, kN/m <sup>2</sup>			
		1.50	3.33	1.50	3.33
140	200	1.63	1.46	1.31	1.23
	300	2.43	2.18	1.96	1.84
	400	3.22	2.90	2.60	2.42
	500	4.00	3.60	3.25	2.70
	600	4.71	4.20	3.61	2.97
150	200	1.67	1.49	1.33	1.25
	300	2.48	2.23	1.99	1.87
	400	3.29	2.96	2.64	2.45
	500	4.80	3.68	3.29	2.74
	600	4.87	4.20	3.64	3.02
160	200	1.70	1.53	1.35	1.27
	300	2.53	2.28	2.02	1.90
	400	3.36	3.02	2.68	2.48

	500	4.16	3.76	3.27	2.78
	600	4.95	4.20	3.61	3.08
190	200	1.80	1.61	1.39	1.32
	300	2.67	2.40	2.09	1.97
	400	3.53	3.19	2.77	2.56
	500	4.38	3.81	3.18	2.90
	600	4.92	4.19	3.50	3.21
200	200	1.83	1.64	1.41	1.33
	300	2.87	2.44	2.11	2.00
	400	3.78	3.24	2.79	2.55
	500	4.46	3.81	3.15	2.89
	600	4.86	4.18	3.47	3.18
240	200	2.07	1.74	1.46	1.38
	300	3.07	2.59	2.18	2.07
	400	3.95	3.38	2.70	2.48
	500	4.40	3.80	3.04	2.80
	600	4.78	4.16	3.34	3.08

Notes to Table 9.20.17.4.-C:

(1) Deflection criterion is  $L/240$ , where "L" is the clear span of the lintel.

(2) Linear interpolation is permitted between ground snow loads and between lintel depths.

(3) 10M stirrups are required at a maximum  $d/2$  spacing for spans greater than 1 200 mm, where "d" is the distance from the top of the lintel to the level of the bottom reinforcing bar in the lintel.

**Table 9.23.4.2.-A**

**Maximum Spans for Floor Joists – General Cases(1)**

**Forming Part of Sentences 9.3.2.8.(1), 9.23.4.2.(1) and (2), 9.23.4.4.(1) and 9.23.9.4.(1) to (3)**

Commercial Designation	Grade	Joist Size, mm	Maximum Span, m								
			With Strapping <sup>(2)</sup>			With Bridging			With Strapping <sup>(2)</sup> and Bridging		
			Joist Spacing, mm			Joist Spacing, mm			Joist Spacing, mm		
			300	400	600	300	400	600	300	400	600
Douglas Fir – Larch (includes Douglas Fir and Western Larch)	Select Structural	38 × 89	2.13	1.97	1.73	2.19	1.99	1.73	2.19	1.99	1.73
		38 × 140	3.23	3.07	2.73	3.44	3.12	2.73	3.44	3.12	2.73
		38 × 184	3.88	3.69	3.51	4.18	3.92	3.59	4.37	4.07	3.59
		38 × 235	4.57	4.34	4.13	4.86	4.57	4.29	5.05	4.70	4.39
		38 × 286	5.21	4.95	4.71	5.49	5.16	4.85	5.66	5.28	4.92
	No. 1 and No. 2	38 × 89	2.00	1.85	1.66	2.09	1.90	1.66	2.09	1.90	1.66
		38 × 140	3.09	2.91	2.62	3.29	2.99	2.62	3.29	2.99	2.62

		38 × 184	3.71	3.53	3.36	4.00	3.76	3.44	4.19	3.90	3.44	
		38 × 235	4.38	4.16	3.96	4.66	4.38	4.11	4.84	4.51	4.20	
		38 × 286	4.99	4.75	4.52	5.26	4.94	4.65	5.43	5.06	4.72	
	No. 3	38 × 89	1.90	1.69	1.38	1.95	1.69	1.38	1.95	1.69	1.38	
		38 × 140	2.78	2.41	1.97	2.78	2.41	1.97	2.78	2.41	1.97	
		38 × 184	3.38	2.93	2.39	3.38	2.93	2.39	3.38	2.93	2.39	
		38 × 235	4.14	3.58	2.93	4.14	3.58	2.93	4.14	3.58	2.93	
		38 × 286	4.80	4.16	3.39	4.80	4.16	3.39	4.80	4.16	3.39	
	Construction	38 × 89	1.90	1.77	1.61	2.03	1.84	1.61	2.03	1.84	1.61	
	Standard	38 × 89	1.81	1.63	1.33	1.88	1.63	1.33	1.88	1.63	1.33	
Hem – Fir (includes Western Hemlock and Amabilis Fir)	Select Structural	38 × 89	2.08	1.93	1.71	2.16	1.96	1.71	2.16	1.96	1.71	
		38 × 140	3.18	3.03	2.69	3.39	3.08	2.69	3.39	3.08	2.69	
		38 × 184	3.82	3.64	3.46	4.12	3.87	3.54	4.31	4.02	3.54	
		38 × 235	4.50	4.28	4.08	4.80	4.51	4.23	4.98	4.64	4.33	
		38 × 286	5.14	4.89	4.65	5.42	5.09	4.78	5.59	5.21	4.86	
	No. 1 and No. 2	38 × 89	2.00	1.85	1.66	2.09	1.90	1.66	2.09	1.90	1.66	
		38 × 140	3.09	2.91	2.62	3.29	2.99	2.62	3.29	2.99	2.62	
		38 × 184	3.71	3.53	3.36	4.00	3.76	3.44	4.19	3.90	3.44	
		38 × 235	4.38	4.16	3.96	4.66	4.38	4.11	4.84	4.51	4.20	
		38 × 286	4.99	4.75	4.52	5.26	4.94	4.65	5.43	5.06	4.72	
	No. 3	38 × 89	1.90	1.77	1.61	2.03	1.84	1.61	2.03	1.84	1.61	
		38 × 140	2.99	2.78	2.43	3.19	2.90	2.43	3.19	2.90	2.43	
		38 × 184	3.60	3.42	2.95	3.88	3.61	2.95	4.06	3.61	2.95	
		38 × 235	4.24	4.03	3.61	4.51	4.24	3.61	4.68	4.37	3.61	
		38 × 286	4.84	4.60	4.19	5.10	4.79	4.19	5.26	4.90	4.19	
	Construction	38 × 89	1.90	1.77	1.61	2.03	1.84	1.61	2.03	1.84	1.61	
	Standard	38 × 89	1.81	1.68	1.39	1.96	1.71	1.39	1.96	1.71	1.39	
	Spruce – Pine – Fir (includes Spruce (all species except Coast Sitka Spruce), Jack Pine, Lodgepole Pine, Balsam Fir and Alpine Fir)	Select Structural	38 × 89	1.95	1.81	1.64	2.06	1.87	1.64	2.06	1.87	1.64
			38 × 140	3.05	2.85	2.57	3.24	2.95	2.57	3.24	2.95	2.57
			38 × 184	3.66	3.48	3.31	3.94	3.70	3.38	4.12	3.84	3.38
38 × 235			4.31	4.10	3.90	4.59	4.31	4.05	4.76	4.44	4.14	
38 × 286			4.91	4.67	4.45	5.18	4.87	4.57	5.34	4.98	4.64	
No. 1 and No. 2		38 × 89	1.86	1.72	1.58	1.99	1.81	1.58	1.99	1.81	1.58	
		38 × 140	2.92	2.71	2.49	3.14	2.85	2.49	3.14	2.85	2.49	
		38 × 184	3.54	3.36	3.20	3.81	3.58	3.27	3.99	3.72	3.27	
		38 × 235	4.17	3.96	3.77	4.44	4.17	3.92	4.60	4.29	4.00	
		38 × 286	4.75	4.52	4.30	5.01	4.71	4.42	5.17	4.82	4.49	



	No. 3	38 × 89	1.81	1.68	1.55	1.96	1.78	1.55	1.96	1.78	1.55
		38 × 140	2.84	2.64	2.43	3.08	2.80	2.43	3.08	2.80	2.43
		38 × 184	3.47	3.30	2.95	3.74	3.52	2.95	3.92	3.61	2.95
		38 × 235	4.09	3.89	3.61	4.36	4.09	3.61	4.52	4.22	3.61
		38 × 286	4.67	4.44	4.19	4.92	4.62	4.19	5.08	4.73	4.19
	Construction	38 × 89	1.81	1.68	1.55	1.96	1.78	1.55	1.96	1.78	1.55
	Standard	38 × 89	1.70	1.58	1.44	1.88	1.71	1.44	1.88	1.71	1.44
Northern Species (includes any Canadian species covered by the NLGA Standard Grading Rules)	Select Structural	38 × 89	1.65	1.53	1.42	1.84	1.68	1.46	1.84	1.68	1.46
		38 × 140	2.59	2.41	2.24	2.90	2.63	2.30	2.90	2.63	2.30
		38 × 184	3.27	3.11	2.94	3.52	3.31	3.03	3.69	3.44	3.03
		38 × 235	3.85	3.66	3.48	4.10	3.85	3.62	4.26	3.97	3.70
		38 × 286	4.39	4.18	3.97	4.63	4.35	4.09	4.78	4.45	4.15
	No. 1 and No. 2	38 × 89	1.59	1.48	1.37	1.80	1.64	1.43	1.80	1.64	1.43
		38 × 140	2.51	2.33	2.16	2.83	2.57	2.25	2.83	2.57	2.25
		38 × 184	3.19	3.04	2.84	3.44	3.23	2.96	3.60	3.36	2.96
		38 × 235	3.76	3.58	3.41	4.01	3.77	3.54	4.16	3.88	3.62
		38 × 286	4.29	4.08	3.88	4.53	4.25	4.00	4.67	4.35	4.06
	No. 3	38 × 89	1.54	1.43	1.32	1.74	1.57	1.36	1.76	1.60	1.36
		38 × 140	2.42	2.24	1.94	2.74	2.38	1.94	2.75	2.38	1.94
		38 × 184	3.12	2.90	2.37	3.35	2.90	2.37	3.35	2.90	2.37
		38 × 235	3.67	3.49	2.89	3.91	3.54	2.89	4.06	3.54	2.89
		38 × 286	4.19	3.98	3.36	4.42	4.11	3.36	4.55	4.11	3.36
	Construction	38 × 89	1.54	1.43	1.32	1.74	1.57	1.40	1.76	1.60	1.40
	Standard	38 × 89	1.48	1.37	1.15	1.63	1.41	1.15	1.63	1.41	1.15

**Notes to Table 9.23.4.2.-A:**

<sup>(1)</sup> Spans apply only where the floors serve residential areas as described in Table 4.1.5.3., or the uniformly distributed *live load* on the floors does not exceed that specified for residential areas as described in Table 4.1.5.3.

<sup>(2)</sup> See Sentence 9.23.9.4.(5) for alternatives to strapping.

**Table 9.23.4.2.-B**

**Maximum Spans for Floor Joists – Special Cases(1)**

**Forming Part of Sentences 9.3.2.8.(1), 9.23.4.2.(1) and (2), 9.23.4.4.(2) and 9.23.9.4.(4) and (6)**

Commercial Designation	Grade	Joist Size, mm	Maximum Span, m		
			Joists with Ceilings Attached to Wood Furring		Joists with Concrete Topping
			Without Bridging	With Bridging	With or Without Bridging <sup>(2)</sup>

			Joist Spacing, mm			Joist Spacing, mm			Joist Spacing, mm			
			300	400	600	300	400	600	300	400	600	
Douglas Fir – Larch (includes Douglas Fir and Western Larch)	Select Structural	38 × 89	2.19	1.99	1.73	2.19	1.99	1.73	2.19	1.99	1.73	
		38 × 140	3.44	3.12	2.73	3.44	3.12	2.73	3.44	3.12	2.73	
		38 × 184	4.24	3.99	3.59	4.52	4.11	3.59	4.52	4.11	3.59	
		38 × 235	4.98	4.69	4.29	5.47	5.20	4.58	5.77	5.24	4.58	
		38 × 286	5.67	5.34	4.88	6.19	5.89	5.54	6.83	6.37	5.58	
	No. 1 and No. 2	38 × 89	2.09	1.90	1.66	2.09	1.90	1.66	2.09	1.90	1.66	
		38 × 140	3.29	2.99	2.62	3.29	2.99	2.62	3.29	2.99	2.55	
		38 × 184	4.06	3.83	3.44	4.33	3.93	3.44	4.33	3.81	3.11	
		38 × 235	4.78	4.50	4.11	5.24	4.98	4.31	5.37	4.65	3.80	
		38 × 286	5.44	5.12	4.68	5.93	5.64	5.00	6.24	5.40	4.41	
	No. 3	38 × 89	1.95	1.69	1.38	1.95	1.69	1.38	1.72	1.49	1.21	
		38 × 140	2.78	2.41	1.97	2.78	2.41	1.97	2.45	2.12	1.73	
		38 × 184	3.38	2.93	2.39	3.38	2.93	2.39	2.98	2.58	2.11	
		38 × 235	4.14	3.58	2.93	4.14	3.58	2.93	3.65	3.16	2.58	
		38 × 286	4.80	4.16	3.39	4.80	4.16	3.39	4.23	3.66	2.99	
	Construction	38 × 89	2.03	1.84	1.61	2.03	1.84	1.61	2.03	1.84	1.61	
	Standard	38 × 89	1.88	1.63	1.33	1.88	1.63	1.33	1.66	1.44	1.17	
	Hem – Fir (includes Western Hemlock and Amabilis Fir)	Select Structural	38 × 89	2.16	1.96	1.71	2.16	1.96	1.71	2.16	1.96	1.71
			38 × 140	3.39	3.08	2.69	3.39	3.08	2.69	3.39	3.08	2.69
			38 × 184	4.18	3.94	3.54	4.46	4.05	3.54	4.46	4.05	3.54
38 × 235			4.92	4.63	4.23	5.39	5.13	4.52	5.69	5.17	4.52	
38 × 286			5.60	5.27	4.82	6.10	5.81	5.47	6.74	6.28	5.50	
No. 1 and No. 2		38 × 89	2.09	1.90	1.66	2.09	1.90	1.66	2.09	1.90	1.66	
		38 × 140	3.29	2.99	2.62	3.29	2.99	2.62	3.29	2.99	2.62	
		38 × 184	4.06	3.83	3.44	4.33	3.93	3.44	4.33	3.93	3.26	
		38 × 235	4.78	4.50	4.11	5.24	4.98	4.39	5.53	4.88	3.99	
		38 × 286	5.44	5.12	4.68	5.93	5.64	5.25	6.54	5.66	4.63	
No. 3		38 × 89	2.03	1.84	1.61	2.03	1.84	1.61	2.03	1.83	1.50	
		38 × 140	3.19	2.90	2.43	3.19	2.90	2.43	3.02	2.62	2.14	
		38 × 184	3.94	3.61	2.95	4.17	3.61	2.95	3.68	3.18	2.60	
		38 × 235	4.63	4.36	3.61	5.08	4.42	3.61	4.50	3.89	3.18	
		38 × 286	5.27	4.96	4.19	5.74	5.13	4.19	5.22	4.52	3.69	
Construction		38 × 89	2.03	1.84	1.61	2.03	1.84	1.61	2.03	1.84	1.61	
Standard		38 × 89	1.96	1.71	1.39	1.96	1.71	1.39	1.74	1.50	1.23	
			38 × 89	2.06	1.87	1.64	2.06	1.87	1.64	2.06	1.87	1.64

Spruce – Pine – Fir (includes Spruce (all species except Coast Sitka Spruce), Jack Pine, Lodgepole Pine, Balsam Fir and Alpine Fir)	Select Structural	38 × 140	3.24	2.95	2.57	3.24	2.95	2.57	3.24	2.95	2.57	
		38 × 184	4.00	3.77	3.38	4.26	3.87	3.38	4.26	3.87	3.38	
		38 × 235	4.70	4.43	4.05	5.16	4.91	4.32	5.45	4.95	4.32	
		38 × 286	5.35	5.04	4.61	5.84	5.55	5.23	6.45	6.01	5.26	
	No. 1 and No. 2	38 × 89	1.99	1.81	1.58	1.99	1.81	1.58	1.99	1.81	1.58	
		38 × 140	3.14	2.85	2.49	3.14	2.85	2.49	3.14	2.85	2.49	
		38 × 184	3.87	3.64	3.27	4.12	3.75	3.27	4.12	3.75	3.27	
		38 × 235	4.55	4.28	3.91	4.99	4.75	4.18	5.27	4.79	4.13	
		38 × 286	5.18	4.88	4.46	5.65	5.37	5.06	6.23	5.81	4.79	
	No. 3	38 × 89	1.96	1.78	1.55	1.96	1.78	1.55	1.96	1.78	1.50	
		38 × 140	3.08	2.80	2.43	3.08	2.80	2.43	3.02	2.62	2.14	
		38 × 184	3.80	3.58	2.95	4.05	3.61	2.95	3.68	3.18	2.60	
		38 × 235	4.47	4.21	3.61	4.90	4.42	3.61	4.50	3.89	3.18	
		38 × 286	5.09	4.79	4.19	5.55	5.13	4.19	5.22	4.52	3.69	
	Construction	38 × 89	1.96	1.78	1.55	1.96	1.78	1.55	1.96	1.78	1.55	
	Standard	38 × 89	1.88	1.71	1.44	1.88	1.71	1.44	1.80	1.56	1.27	
	Northern Species (includes any Canadian species covered by the NLGA Standard Grading Rules)	Select Structural	38 × 89	1.84	1.68	1.46	1.84	1.68	1.46	1.84	1.68	1.46
			38 × 140	2.90	2.63	2.30	2.90	2.63	2.30	2.90	2.63	2.30
38 × 184			3.58	3.37	3.03	3.81	3.46	3.03	3.81	3.46	3.03	
38 × 235			4.20	3.96	3.62	4.61	4.39	3.86	4.87	4.42	3.86	
38 × 286			4.79	4.51	4.12	5.22	4.96	4.68	5.76	5.37	4.54	
No. 1 and No. 2		38 × 89	1.80	1.64	1.43	1.80	1.64	1.43	1.80	1.64	1.43	
		38 × 140	2.83	2.57	2.25	2.83	2.57	2.25	2.83	2.57	2.23	
		38 × 184	3.50	3.29	2.96	3.72	3.38	2.96	3.72	3.32	2.71	
		38 × 235	4.11	3.87	3.54	4.51	4.29	3.76	4.69	4.06	3.31	
		38 × 286	4.68	4.40	4.03	5.10	4.85	4.36	5.44	4.71	3.84	
No. 3		38 × 89	1.76	1.60	1.36	1.76	1.60	1.36	1.70	1.47	1.20	
		38 × 140	2.75	2.38	1.94	2.75	2.38	1.94	2.42	2.10	1.71	
		38 × 184	3.35	2.90	2.37	3.35	2.90	2.37	2.95	2.55	2.08	
		38 × 235	4.01	3.54	2.89	4.09	3.54	2.89	3.61	3.12	2.55	
		38 × 286	4.56	4.11	3.36	4.75	4.11	3.36	4.18	3.62	2.96	
Construction		38 × 89	1.76	1.60	1.40	1.76	1.60	1.40	1.76	1.60	1.37	
Standard		38 × 89	1.63	1.41	1.15	1.63	1.41	1.15	1.44	1.25	1.02	

Notes to Table 9.23.4.2.-B:

(1) Spans apply only where the floors serve residential areas as described in Table 4.1.5.3., or the uniformly distributed live load on the floors does not exceed that specified for residential areas as described in Table 4.1.5.3.

(2) No bridging is assumed for spans for floor joists with concrete topping.

**Table 9.23.4.2.-C**

**Maximum Spans for Ceiling Joists – Attic not Accessible by a Stairway  
Forming Part of Sentences 9.3.2.8.(1), 9.23.4.2.(1) and 9.23.14.10.(2)**

Commercial Designation	Grade	Joist Size, mm	Maximum Span, m			
			Joist Spacing, mm			
			300	400	600	
Douglas Fir – Larch (includes Douglas Fir and Western Larch)	Select Structural	38 × 89	3.41	3.10	2.71	
		38 × 140	5.37	4.88	4.26	
		38 × 184	7.05	6.41	5.60	
		38 × 235	9.01	8.18	7.15	
		38 × 286	10.96	9.96	8.70	
	No. 1 and No. 2	38 × 89	3.27	2.97	2.59	
		38 × 140	5.14	4.67	4.08	
		38 × 184	6.76	6.14	5.36	
		38 × 235	8.63	7.84	6.85	
		38 × 286	10.50	9.54	8.34	
	No. 3	38 × 89	3.17	2.88	2.42	
		38 × 140	4.89	4.23	3.46	
		38 × 184	5.95	5.15	4.20	
		38 × 235	7.27	6.30	5.14	
		38 × 286	8.44	7.31	5.97	
	Construction	38 × 89	3.17	2.88	2.51	
	Standard	38 × 89	3.06	2.78	2.34	
	Hem – Fir (includes Western Hemlock and Amabilis Fir)	Select Structural	38 × 89	3.36	3.06	2.67
			38 × 140	5.29	4.81	4.20
			38 × 184	6.96	6.32	5.52
38 × 235			8.88	8.07	7.05	
38 × 286			10.81	9.82	8.58	
No. 1 and No. 2		38 × 89	3.27	2.97	2.59	
		38 × 140	5.14	4.67	4.08	
		38 × 184	6.76	6.14	5.36	
		38 × 235	8.63	7.84	6.85	
		38 × 286	10.50	9.54	8.34	
No. 3		38 × 89	3.17	2.88	2.51	
		38 × 140	4.98	4.53	3.95	
		38 × 184	6.55	5.95	5.19	
		38 × 235	8.36	7.60	6.34	

		38 × 286	10.18	9.01	7.36	
	Construction	38 × 89	3.17	2.88	2.50	
	Standard	38 × 89	3.06	2.78	2.43	
Spruce – Pine – Fir (includes Spruce (all species except Coast Sitka Spruce), Jack Pine, Lodgepole Pine, Balsam Fir and Alpine Fir)	Select Structural	38 × 89	3.22	2.92	2.55	
		38 × 140	5.06	4.60	4.02	
		38 × 184	6.65	6.05	5.28	
		38 × 235	8.50	7.72	6.74	
		38 × 286	10.34	9.40	8.21	
	No. 1 and No. 2	38 × 89	3.11	2.83	2.47	
		38 × 140	4.90	4.45	3.89	
		38 × 184	6.44	5.85	5.11	
		38 × 235	8.22	7.47	6.52	
		38 × 286	10.00	9.09	7.94	
	No. 3	38 × 89	3.06	2.78	2.43	
		38 × 140	4.81	4.37	3.82	
		38 × 184	6.32	5.74	5.02	
		38 × 235	8.07	7.33	6.34	
		38 × 286	9.82	8.93	7.36	
	Construction	38 × 89	3.06	2.78	2.43	
	Standard	38 × 89	2.94	2.67	2.33	
	Northern Species (includes any Canadian species covered by the NLGA Standard Grading Rules)	Select Structural	38 × 89	2.88	2.61	2.28
			38 × 140	4.53	4.11	3.59
			38 × 184	5.95	5.40	4.72
38 × 235			7.60	6.90	6.03	
38 × 286			9.25	8.40	7.34	
No. 1 and No. 2		38 × 89	2.81	2.55	2.23	
		38 × 140	4.42	4.02	3.51	
		38 × 184	5.81	5.28	4.61	
		38 × 235	7.42	6.74	5.89	
		38 × 286	9.03	8.21	7.17	
No. 3		38 × 89	2.74	2.49	2.18	
		38 × 140	4.31	3.92	3.42	
		38 × 184	5.67	5.09	4.16	
		38 × 235	7.19	6.23	5.08	
		38 × 286	8.34	7.23	5.90	
Construction		38 × 89	2.74	2.49	2.18	
Standard		38 × 89	2.67	2.43	2.03	

**Table 9.23.4.2.-D**

**Maximum Spans for Roof Joists – Specified Roof Snow Loads 1.0 to 2.0 kPa**

**Forming Part of Sentences 9.3.2.8.(1), 9.23.4.2.(1), 9.23.4.5.(1) and 9.23.14.10.(2)**

Commercial Designation	Grade	Joist Size, mm	Maximum Span, m									
			Specified Snow Load, kPa									
			1.0			1.5			2.0			
			Joist Spacing, mm			Joist Spacing, mm			Joist Spacing, mm			
			300	400	600	300	400	600	300	400	600	
Douglas Fir – Larch (includes Douglas Fir and Western Larch)	Select Structural	38 × 89	2.71	2.46	2.15	2.37	2.15	1.88	2.15	1.95	1.71	
		38 × 140	4.26	3.87	3.38	3.72	3.38	2.95	3.38	3.07	2.68	
		38 × 184	5.60	5.09	4.44	4.89	4.44	3.88	4.44	4.04	3.53	
		38 × 235	7.15	6.49	5.67	6.24	5.67	4.96	5.67	5.15	4.50	
		38 × 286	8.70	7.90	6.91	7.60	6.91	6.03	6.91	6.27	5.48	
	No. 1 and No. 2	38 × 89	2.59	2.36	2.06	2.27	2.06	1.80	2.06	1.87	1.63	
		38 × 140	4.08	3.71	3.24	3.57	3.24	2.83	3.24	2.94	2.57	
		38 × 184	5.36	4.87	4.26	4.69	4.26	3.72	4.26	3.87	3.38	
		38 × 235	6.85	6.22	5.44	5.98	5.44	4.74	5.44	4.94	4.22	
		38 × 286	8.34	7.57	6.40	7.28	6.62	5.50	6.62	6.00	4.90	
	No. 3	38 × 89	2.49	2.16	1.76	2.14	1.85	1.51	1.91	1.65	1.35	
		38 × 140	3.56	3.08	2.51	3.06	2.65	2.16	2.72	2.36	1.92	
		38 × 184	4.33	3.75	3.06	3.72	3.22	2.63	3.31	2.87	2.34	
		38 × 235	5.29	4.58	3.74	4.55	3.94	3.22	4.05	3.51	2.86	
		38 × 286	6.14	5.32	4.34	5.28	4.57	3.73	4.70	4.07	3.32	
	Construction	38 × 89	2.51	2.28	1.99	2.20	1.99	1.74	1.99	1.81	1.58	
	Standard	38 × 89	2.41	2.08	1.70	2.07	1.79	1.46	1.84	1.60	1.30	
	Hem – Fir (includes Western Hemlock and Amabilis Fir)	Select Structural	38 × 89	2.67	2.43	2.12	2.33	2.12	1.85	2.12	1.93	1.68
			38 × 140	4.20	3.82	3.33	3.67	3.33	2.91	3.33	3.03	2.65
			38 × 184	5.52	5.02	4.38	4.82	4.38	3.83	4.38	3.98	3.48
			38 × 235	7.05	6.41	5.60	6.16	5.60	4.89	5.60	5.09	4.44
38 × 286			8.58	7.80	6.81	7.50	6.81	5.95	6.81	6.19	5.41	
No. 1 and No. 2		38 × 89	2.59	2.36	2.06	2.27	2.06	1.80	2.06	1.87	1.63	
		38 × 140	4.08	3.71	3.24	3.57	3.24	2.83	3.24	2.94	2.57	
		38 × 184	5.36	4.87	4.26	4.69	4.26	3.72	4.26	3.87	3.38	
		38 × 235	6.85	6.22	5.44	5.98	5.44	4.75	5.44	4.94	4.32	
		38 × 286	8.34	7.57	6.62	7.28	6.62	5.77	6.62	6.01	5.25	
No. 3		38 × 89	2.51	2.28	1.99	2.20	1.99	1.74	1.99	1.81	1.58	

		38 × 140	3.95	3.59	3.10	3.45	3.14	2.67	3.14	2.85	2.37	
		38 × 184	5.20	4.62	3.77	4.54	3.97	3.24	4.09	3.54	2.89	
		38 × 235	6.53	5.65	4.61	5.61	4.86	3.97	5.00	4.33	3.53	
		38 × 286	7.57	6.56	5.35	6.51	5.64	4.60	5.80	5.02	4.10	
	Construction	38 × 89	2.51	2.28	1.99	2.20	1.99	1.74	1.99	1.81	1.58	
	Standard	38 × 89	2.43	2.18	1.78	2.12	1.88	1.53	1.93	1.67	1.36	
Spruce – Pine – Fir (includes Spruce (all species except Coast Sitka Spruce), Jack Pine, Lodgepole Pine, Balsam Fir and Alpine Fir)	Select Structural	38 × 89	2.55	2.32	2.03	2.23	2.03	1.77	2.03	1.84	1.61	
		38 × 140	4.02	3.65	3.19	3.51	3.19	2.79	3.19	2.90	2.53	
		38 × 184	5.28	4.80	4.19	4.61	4.19	3.66	4.19	3.81	3.33	
		38 × 235	6.74	6.13	5.35	5.89	5.35	4.68	5.35	4.86	4.25	
		38 × 286	8.21	7.46	6.52	7.17	6.52	5.69	6.52	5.92	5.17	
	No. 1 and No. 2	38 × 89	2.47	2.24	1.96	2.16	1.96	1.71	1.96	1.78	1.56	
		38 × 140	3.89	3.53	3.08	3.40	3.08	2.69	3.08	2.80	2.45	
		38 × 184	5.11	4.64	4.05	4.46	4.05	3.54	4.05	3.68	3.22	
		38 × 235	6.52	5.93	5.18	5.70	5.18	4.52	5.18	4.70	4.11	
		38 × 286	7.94	7.21	6.30	6.94	6.30	5.50	6.30	5.73	5.00	
	No. 3	38 × 89	2.43	2.20	1.93	2.12	1.93	1.68	1.93	1.75	1.53	
		38 × 140	3.82	3.47	3.03	3.33	3.03	2.65	3.03	2.75	2.37	
		38 × 184	5.02	4.56	3.77	4.38	3.97	3.24	3.98	3.54	2.89	
		38 × 235	6.41	5.65	4.61	5.60	4.86	3.97	5.00	4.33	3.53	
		38 × 286	7.57	6.56	5.35	6.51	5.64	4.60	5.80	5.02	4.10	
	Construction	38 × 89	2.43	2.20	1.93	2.12	1.93	1.68	1.93	1.75	1.53	
	Standard	38 × 89	2.33	2.12	1.85	2.04	1.85	1.59	1.85	1.68	1.41	
	Northern Species (includes any Canadian species covered by the NLGA Standard Grading Rules)	Select Structural	38 × 89	2.28	2.07	1.81	1.99	1.81	1.58	1.81	1.65	1.44
			38 × 140	3.59	3.26	2.85	3.14	2.85	2.49	2.85	2.59	2.26
			38 × 184	4.72	4.29	3.75	4.12	3.75	3.27	3.75	3.40	2.97
38 × 235			6.03	5.48	4.79	5.27	4.79	4.18	4.79	4.35	3.80	
38 × 286			7.34	6.67	5.82	6.41	5.82	5.09	5.82	5.29	4.62	
No. 1 and No. 2		38 × 89	2.23	2.03	1.77	1.95	1.77	1.55	1.77	1.61	1.41	
		38 × 140	3.51	3.19	2.79	3.07	2.79	2.43	2.79	2.53	2.21	
		38 × 184	4.61	4.19	3.66	4.03	3.66	3.20	3.66	3.33	2.91	
		38 × 235	5.89	5.35	4.68	5.15	4.68	4.09	4.68	4.25	3.68	
		38 × 286	7.17	6.52	5.58	6.26	5.69	4.80	5.69	5.17	4.27	
No. 3		38 × 89	2.18	1.98	1.73	1.90	1.73	1.50	1.73	1.57	1.33	
		38 × 140	3.42	3.05	2.49	2.99	2.62	2.14	2.69	2.33	1.90	
		38 × 184	4.28	3.71	3.03	3.68	3.19	2.60	3.28	2.84	2.32	
		38 × 235	5.23	4.53	3.70	4.50	3.90	3.18	4.01	3.47	2.83	

		38 × 286	6.07	5.26	4.29	5.22	4.52	3.69	4.65	4.03	3.29
	Construction	38 × 89	2.18	1.98	1.73	1.90	1.73	1.51	1.73	1.57	1.37
	Standard	38 × 89	2.09	1.81	1.48	1.80	1.56	1.27	1.60	1.38	1.13

**Table 9.23.4.2.-E**

**Maximum Spans for Roof Joists – Specified Roof Snow Loads 2.5 and 3.0 kPa**

**Forming Part of Sentences 9.3.2.8.(1), 9.23.4.2.(1), 9.23.4.5.(1) and 9.23.14.10.(2)**

Commercial Designation	Grade	Joist Size, mm	Maximum Span, m					
			Specified Snow Load, kPa					
			2.5			3.0		
			Joist Spacing, mm			Joist Spacing, mm		
			300	400	600	300	400	600
Douglas Fir – Larch (includes Douglas Fir and Western Larch)	Select Structural	38 × 89	1.99	1.81	1.58	1.88	1.71	1.49
		38 × 140	3.14	2.85	2.49	2.95	2.68	2.34
		38 × 184	4.12	3.75	3.27	3.88	3.53	3.08
		38 × 235	5.27	4.79	4.18	4.96	4.50	3.93
		38 × 286	6.41	5.82	5.09	6.03	5.48	4.79
	No. 1 and No. 2	38 × 89	1.91	1.74	1.52	1.80	1.63	1.43
		38 × 140	3.01	2.73	2.39	2.83	2.57	2.25
		38 × 184	3.95	3.59	3.14	3.72	3.38	2.90
		38 × 235	5.05	4.59	3.84	4.75	4.32	3.55
		38 × 286	6.14	5.46	4.46	5.78	5.05	4.12
	No. 3	38 × 89	1.74	1.50	1.23	1.60	1.39	1.13
		38 × 140	2.48	2.15	1.75	2.29	1.98	1.62
		38 × 184	3.01	2.61	2.13	2.79	2.41	1.97
		38 × 235	3.69	3.19	2.61	3.41	2.95	2.41
		38 × 286	4.28	3.70	3.03	3.95	3.42	2.79
	Construction	38 × 89	1.85	1.68	1.47	1.74	1.58	1.38
	Standard	38 × 89	1.68	1.45	1.19	1.55	1.34	1.10
	Hem – Fir (includes Western Hemlock and Amabilis Fir)	Select Structural	38 × 89	1.97	1.79	1.56	1.85	1.68
38 × 140			3.10	2.81	2.46	2.91	2.65	2.31
38 × 184			4.07	3.70	3.23	3.83	3.48	3.04
38 × 235			5.20	4.72	4.12	4.89	4.44	3.88
38 × 286			6.32	5.75	5.02	5.95	5.41	4.72
No. 1 and No. 2		38 × 89	1.91	1.74	1.52	1.80	1.63	1.43
		38 × 140	3.01	2.73	2.39	2.83	2.57	2.25



		38 × 184	3.95	3.59	3.14	3.72	3.38	2.95
		38 × 235	5.05	4.59	4.01	4.75	4.32	3.72
		38 × 286	6.14	5.58	4.68	5.78	5.25	4.32
	No. 3	38 × 89	1.85	1.68	1.47	1.74	1.58	1.38
		38 × 140	2.91	2.65	2.16	2.74	2.45	2.00
		38 × 184	3.72	3.22	2.63	3.44	2.98	2.43
		38 × 235	4.55	3.94	3.22	4.20	3.64	2.97
		38 × 286	5.28	4.57	3.73	4.88	4.22	3.45
	Construction	38 × 89	1.85	1.68	1.47	1.74	1.58	1.38
	Standard	38 × 89	1.76	1.52	1.24	1.62	1.40	1.15
Spruce – Pine – Fir (includes Spruce (all species except Coast Sitka Spruce), Jack Pine, Lodgepole Pine, Balsam Fir and Alpine Fir)	Select Structural	38 × 89	1.88	1.71	1.49	1.77	1.61	1.41
		38 × 140	2.96	2.69	2.35	2.79	2.53	2.21
		38 × 184	3.89	3.54	3.09	3.66	3.33	2.91
		38 × 235	4.97	4.52	3.94	4.68	4.25	3.71
		38 × 286	6.05	5.50	4.80	5.69	5.17	4.52
	No. 1 and No. 2	38 × 89	1.82	1.65	1.44	1.71	1.56	1.36
		38 × 140	2.86	2.60	2.27	2.69	2.45	2.14
		38 × 184	3.76	3.42	2.99	3.54	3.22	2.81
		38 × 235	4.81	4.37	3.82	4.52	4.11	3.59
		38 × 286	5.85	5.31	4.64	5.50	5.00	4.37
	No. 3	38 × 89	1.79	1.62	1.42	1.68	1.53	1.34
		38 × 140	2.81	2.56	2.16	2.65	2.40	2.00
		38 × 184	3.70	3.22	2.63	3.44	2.98	2.43
		38 × 235	4.55	3.94	3.22	4.20	3.64	2.97
		38 × 286	5.28	4.57	3.73	4.88	4.22	3.45
	Construction	38 × 89	1.79	1.62	1.42	1.68	1.53	1.34
	Standard	38 × 89	1.72	1.56	1.29	1.62	1.46	1.19
Northern Species (includes any Canadian species covered by the NLGA Standard Grading Rules)	Select Structural	38 × 89	1.68	1.53	1.34	1.58	1.44	1.26
		38 × 140	2.65	2.40	2.10	2.49	2.26	1.98
		38 × 184	3.48	3.16	2.76	3.27	2.97	2.60
		38 × 235	4.44	4.04	3.53	4.18	3.80	3.32
		38 × 286	5.41	4.91	4.29	5.09	4.62	4.04
	No. 1 and No. 2	38 × 89	1.64	1.49	1.31	1.55	1.41	1.23
		38 × 140	2.59	2.35	2.05	2.43	2.21	1.93
		38 × 184	3.40	3.09	2.70	3.20	2.91	2.53
		38 × 235	4.34	3.94	3.35	4.09	3.71	3.10
		38 × 286	5.28	4.76	3.89	4.97	4.40	3.59

	No. 3	38 × 89	1.60	1.46	1.21	1.51	1.37	1.12
		38 × 140	2.45	2.12	1.73	2.26	1.96	1.60
		38 × 184	2.98	2.58	2.11	2.76	2.39	1.95
		38 × 235	3.65	3.16	2.58	3.37	2.92	2.38
		38 × 286	4.23	3.66	2.99	3.91	3.39	2.76
	Construction	38 × 89	1.60	1.46	1.27	1.51	1.37	1.20
	Standard	38 × 89	1.46	1.26	1.03	1.34	1.16	0.95

**Table 9.23.4.2.-F**

**Maximum Spans for Roof Rafters – Specified Roof Snow Loads 1.0 to 2.0 kPa**

**Forming Part of Sentences 9.3.2.8.(1), 9.23.4.2.(1), 9.23.4.5.(1) and 9.23.14.10.(2)**

Commercial Designation	Grade	Rafter Size, mm	Maximum Span, m									
			Specified Snow Load, kPa									
			1.0			1.5			2.0			
			Rafter Spacing, mm			Rafter Spacing, mm			Rafter Spacing, mm			
			300	400	600	300	400	600	300	400	600	
Douglas Fir – Larch (includes Douglas Fir and Western Larch)	Select Structural	38 × 89	3.41	3.10	2.71	2.98	2.71	2.37	2.71	2.46	2.15	
		38 × 140	5.37	4.88	4.26	4.69	4.26	3.72	4.26	3.87	3.38	
		38 × 184	7.05	6.41	5.60	6.16	5.60	4.89	5.60	5.09	4.44	
		38 × 235	9.01	8.18	7.15	7.87	7.15	6.24	7.15	6.49	5.62	
		38 × 286	10.96	9.96	8.70	9.58	8.70	7.40	8.70	7.90	6.52	
	No. 1 and No. 2	38 × 89	3.27	2.97	2.59	2.86	2.59	2.27	2.59	2.36	2.06	
		38 × 140	5.14	4.67	3.95	4.49	4.08	3.34	4.08	3.60	2.94	
		38 × 184	6.76	5.88	4.80	5.74	4.97	4.06	5.06	4.38	3.58	
		38 × 235	8.30	7.19	5.87	7.02	6.08	4.96	6.19	5.36	4.38	
		38 × 286	9.63	8.34	6.81	8.14	7.05	5.76	7.18	6.22	5.08	
	No. 3	38 × 89	2.65	2.30	1.87	2.24	1.94	1.58	1.98	1.71	1.40	
		38 × 140	3.78	3.28	2.68	3.20	2.77	2.26	2.82	2.44	1.99	
		38 × 184	4.61	3.99	3.26	3.89	3.37	2.75	3.43	2.97	2.43	
		38 × 235	5.63	4.88	3.98	4.76	4.12	3.37	4.20	3.64	2.97	
		38 × 286	6.53	5.66	4.62	5.52	4.78	3.91	4.87	4.22	3.44	
	Construction	38 × 89	3.17	2.88	2.42	2.77	2.50	2.04	2.51	2.21	1.80	
	Standard	38 × 89	2.56	2.22	1.81	2.17	1.88	1.53	1.91	1.65	1.35	
	Hem – Fir (includes Western Hemlock)	Select Structural	38 × 89	3.36	3.06	2.67	2.94	2.67	2.33	2.67	2.43	2.12
			38 × 140	5.29	4.81	4.20	4.62	4.20	3.67	4.20	3.82	3.33
			38 × 184	6.96	6.32	5.52	6.08	5.52	4.82	5.52	5.02	4.38

and Amabilis Fir)		38 × 235	8.88	8.07	7.05	7.76	7.05	6.16	7.05	6.41	5.54	
		38 × 286	10.81	9.82	8.58	9.45	8.58	7.28	8.58	7.80	6.42	
	No. 1 and No. 2		38 × 89	3.27	2.97	2.59	2.86	2.59	2.27	2.59	2.36	2.06
			38 × 140	5.14	4.67	4.08	4.49	4.08	3.50	4.08	3.71	3.08
			38 × 184	6.76	6.14	5.04	5.90	5.21	4.26	5.31	4.60	3.75
			38 × 235	8.63	7.54	6.16	7.36	6.37	5.20	6.49	5.62	4.59
			38 × 286	10.11	8.75	7.15	8.54	7.40	6.04	7.53	6.52	5.33
	No. 3		38 × 89	3.17	2.83	2.31	2.76	2.39	1.95	2.44	2.11	1.72
			38 × 140	4.67	4.04	3.30	3.95	3.42	2.79	3.48	3.01	2.46
			38 × 184	5.68	4.92	4.02	4.80	4.16	3.40	4.23	3.67	2.99
			38 × 235	6.95	6.02	4.91	5.87	5.08	4.15	5.18	4.48	3.66
			38 × 286	8.06	6.98	5.70	6.81	5.90	4.82	6.01	5.20	4.25
	Construction	38 × 89	3.17	2.88	2.51	2.77	2.51	2.14	2.51	2.28	1.89	
	Standard	38 × 89	2.68	2.32	1.90	2.27	1.96	1.60	2.00	1.73	1.41	
Spruce – Pine – Fir (includes Spruce (all species except Coast Sitka Spruce), Jack Pine, Lodgepole Pine, Balsam Fir and Alpine Fir)	Select Structural		38 × 89	3.22	2.92	2.55	2.81	2.55	2.23	2.55	2.32	2.03
			38 × 140	5.06	4.60	4.02	4.42	4.02	3.51	4.02	3.65	3.19
			38 × 184	6.65	6.05	5.28	5.81	5.28	4.61	5.28	4.80	4.19
			38 × 235	8.50	7.72	6.74	7.42	6.74	5.89	6.74	6.13	5.35
			38 × 286	10.34	9.40	8.21	9.03	8.21	7.17	8.21	7.46	6.52
	No. 1 and No. 2		38 × 89	3.11	2.83	2.47	2.72	2.47	2.16	2.47	2.24	1.96
			38 × 140	4.90	4.45	3.89	4.28	3.89	3.40	3.89	3.53	3.08
			38 × 184	6.44	5.85	5.11	5.62	5.11	4.41	5.11	4.64	3.89
			38 × 235	8.22	7.47	6.38	7.18	6.52	5.39	6.52	5.82	4.75
			38 × 286	10.00	9.06	7.40	8.74	7.66	6.25	7.80	6.76	5.52
	No. 3		38 × 89	3.06	2.78	2.31	2.67	2.39	1.95	2.43	2.11	1.72
			38 × 140	4.67	4.04	3.30	3.95	3.42	2.79	3.48	3.01	2.46
			38 × 184	5.68	4.92	4.02	4.80	4.16	3.40	4.23	3.67	2.99
			38 × 235	6.95	6.02	4.91	5.87	5.08	4.15	5.18	4.48	3.66
			38 × 286	8.06	6.98	5.70	6.81	5.90	4.82	6.01	5.20	4.25
	Construction	38 × 89	3.06	2.78	2.43	2.67	2.43	2.12	2.43	2.20	1.93	
	Standard	38 × 89	2.78	2.41	1.97	2.35	2.04	1.66	2.07	1.79	1.47	
Northern Species (includes any Canadian species covered by the NLGA Standard	Select Structural		38 × 89	2.88	2.61	2.28	2.51	2.28	1.99	2.28	2.07	1.81
			38 × 140	4.53	4.11	3.59	3.95	3.59	3.14	3.59	3.26	2.85
			38 × 184	5.95	5.40	4.72	5.20	4.72	4.12	4.72	4.29	3.68
			38 × 235	7.60	6.90	6.03	6.64	6.03	5.11	6.03	5.48	4.51
			38 × 286	9.25	8.40	7.01	8.08	7.26	5.93	7.34	6.40	5.23
		38 × 89	2.81	2.55	2.23	2.46	2.23	1.95	2.23	2.03	1.77	

Grading Rules)	No. 1 and No. 2	38 × 140	4.42	4.02	3.44	3.86	3.51	2.91	3.51	3.14	2.56
		38 × 184	5.81	5.13	4.19	5.00	4.33	3.54	4.41	3.82	3.12
		38 × 235	7.24	6.27	5.12	6.12	5.30	4.33	5.40	4.67	3.82
		38 × 286	8.40	7.27	5.94	7.10	6.15	5.02	6.26	5.42	4.43
	No. 3	38 × 89	2.62	2.27	1.85	2.22	1.92	1.57	1.95	1.69	1.38
		38 × 140	3.74	3.24	2.65	3.16	2.74	2.24	2.79	2.42	1.97
		38 × 184	4.56	3.94	3.22	3.85	3.33	2.72	3.40	2.94	2.40
		38 × 235	5.57	4.82	3.94	4.71	4.08	3.33	4.15	3.60	2.94
		38 × 286	6.46	5.60	4.57	5.46	4.73	3.86	4.82	4.17	3.41
	Construction	38 × 89	2.74	2.49	2.11	2.40	2.18	1.90	2.18	1.93	1.57
	Standard	38 × 89	2.22	1.93	1.57	1.88	1.63	1.33	1.66	1.44	1.17

**Table 9.23.4.2.-G**

**Maximum Spans for Roof Rafters – Specified Roof Snow Loads 2.5 and 3.0 kPa  
Forming Part of Sentences 9.3.2.8.(1), 9.23.4.2.(1) and 9.23.4.5.(1)**

Commercial Designation	Grade	Rafter Size, mm	Maximum Span, m					
			Specified Snow Load, kPa					
			2.5			3.0		
			Rafter Spacing, mm			Rafter Spacing, mm		
			300	400	600	300	400	600
Douglas Fir – Larch (includes Douglas Fir and Western Larch)	Select Structural	38 × 89	2.51	2.28	1.99	2.37	2.15	1.88
		38 × 140	3.95	3.59	3.14	3.72	3.38	2.95
		38 × 184	5.20	4.72	4.12	4.89	4.44	3.83
		38 × 235	6.64	6.03	5.08	6.24	5.67	4.68
		38 × 286	8.08	7.23	5.90	7.60	6.65	5.43
	No. 1 and No. 2	38 × 89	2.41	2.19	1.86	2.27	2.06	1.71
		38 × 140	3.76	3.26	2.66	3.46	3.00	2.45
		38 × 184	4.58	3.96	3.24	4.21	3.65	2.98
		38 × 235	5.60	4.85	3.96	5.15	4.46	3.64
		38 × 286	6.50	5.63	4.59	5.98	5.17	4.23
	No. 3	38 × 89	1.79	1.55	1.26	1.64	1.42	1.16
		38 × 140	2.55	2.21	1.80	2.35	2.03	1.66
		38 × 184	3.10	2.69	2.20	2.86	2.47	2.02
		38 × 235	3.80	3.29	2.68	3.49	3.02	2.47
		38 × 286	4.41	3.82	3.12	4.05	3.51	2.87
	Construction	38 × 89	2.30	2.00	1.63	2.12	1.84	1.50

	Standard	38 × 89	1.73	1.50	1.22	1.59	1.38	1.12
Hem – Fir (includes Western Hemlock and Amabilis Fir)	Select Structural	38 × 89	2.48	2.25	1.97	2.33	2.12	1.85
		38 × 140	3.90	3.54	3.10	3.67	3.33	2.91
		38 × 184	5.13	4.66	4.07	4.82	4.38	3.77
		38 × 235	6.55	5.95	5.01	6.16	5.60	4.61
		38 × 286	7.97	7.12	5.81	7.50	6.55	5.34
	No. 1 and No. 2	38 × 89	2.41	2.19	1.91	2.27	2.06	1.80
		38 × 140	3.79	3.42	2.79	3.57	3.14	2.57
		38 × 184	4.80	4.16	3.40	4.42	3.83	3.12
		38 × 235	5.87	5.08	4.15	5.40	4.68	3.82
		38 × 286	6.81	5.90	4.82	6.27	5.43	4.43
	No. 3	38 × 89	2.21	1.91	1.56	2.03	1.76	1.43
		38 × 140	3.15	2.73	2.23	2.90	2.51	2.05
		38 × 184	3.83	3.32	2.71	3.52	3.05	2.49
		38 × 235	4.68	4.06	3.31	4.31	3.73	3.05
		38 × 286	5.43	4.71	3.84	5.00	4.33	3.54
	Construction	38 × 89	2.33	2.09	1.71	2.20	1.93	1.57
	Standard	38 × 89	1.81	1.57	1.28	1.66	1.44	1.18
	Spruce – Pine – Fir (includes Spruce (all species except Coast Sitka Spruce), Jack Pine, Lodgepole Pine, Balsam Fir and Alpine Fir)	Select Structural	38 × 89	2.37	2.15	1.88	2.23	2.03
38 × 140			3.73	3.39	2.96	3.51	3.19	2.79
38 × 184			4.90	4.45	3.89	4.61	4.19	3.66
38 × 235			6.26	5.69	4.97	5.89	5.35	4.68
38 × 286			7.62	6.92	5.90	7.17	6.52	5.43
No. 1 and No. 2		38 × 89	2.29	2.08	1.82	2.16	1.96	1.71
		38 × 140	3.61	3.28	2.86	3.40	3.08	2.66
		38 × 184	4.74	4.31	3.52	4.46	3.96	3.23
		38 × 235	6.06	5.27	4.30	5.59	4.84	3.96
		38 × 286	7.06	6.11	4.99	6.49	5.62	4.59
No. 3		38 × 89	2.21	1.91	1.56	2.03	1.76	1.43
		38 × 140	3.15	2.73	2.23	2.90	2.51	2.05
		38 × 184	3.83	3.32	2.71	3.52	3.05	2.49
		38 × 235	4.68	4.06	3.31	4.31	3.73	3.05
		38 × 286	5.43	4.71	3.84	5.00	4.33	3.54
Construction		38 × 89	2.25	2.05	1.77	2.12	1.93	1.63
Standard		38 × 89	1.87	1.62	1.33	1.72	1.49	1.22
Northern Species (includes any)		Select Structural	38 × 89	2.12	1.93	1.68	1.99	1.81
	38 × 140		3.33	3.03	2.65	3.14	2.85	2.49

Canadian species covered by the NLGA Standard Grading Rules)		38 × 184	4.38	3.98	3.33	4.12	3.75	3.07
		38 × 235	5.60	4.99	4.08	5.27	4.59	3.75
		38 × 286	6.69	5.79	4.73	6.15	5.33	4.35
	No. 1 and No. 2	38 × 89	2.07	1.88	1.62	1.95	1.77	1.49
		38 × 140	3.26	2.84	2.32	3.02	2.61	2.13
		38 × 184	3.99	3.46	2.82	3.67	3.18	2.60
		38 × 235	4.88	4.23	3.45	4.49	3.89	3.17
		38 × 286	5.66	4.90	4.00	5.21	4.51	3.68
	No. 3	38 × 89	1.77	1.53	1.25	1.63	1.41	1.15
		38 × 140	2.52	2.19	1.78	2.32	2.01	1.64
		38 × 184	3.07	2.66	2.17	2.82	2.45	2.00
		38 × 235	3.76	3.25	2.66	3.45	2.99	2.44
		38 × 286	4.36	3.77	3.08	4.01	3.47	2.83
	Construction	38 × 89	2.01	1.74	1.42	1.85	1.60	1.31
	Standard	38 × 89	1.50	1.30	1.06	1.38	1.19	0.98

**Table 9.23.4.2.-H**

**Maximum Spans for Built-up Floor Beams Supporting not more than One Floor(1)(2)**

**Forming Part of Sentences 9.3.2.8.(1), 9.23.4.2.(3), 9.23.4.4.(3) and 9.23.8.1.(1)**

Commercial Designation	Grade	Supported Length, m <sup>(3)(4)</sup>	Maximum Span, m <sup>(5)(6)</sup>								
			Size of Built-up Beam, mm								
			3-38×184	4-38×184	5-38×184	3-38×235	4-38×235	5-38×235	3-38×286	4-38×286	5-38×286
Douglas Fir – Larch (includes Douglas Fir and Western Larch)	Select Structural	2.4	3.36	3.70	3.99	4.30	4.73	5.09	5.23	5.66	5.99
		3.0	3.12	3.44	3.70	3.99	4.39	4.73	4.84	5.34	5.66
		3.6	2.94	3.23	3.48	3.75	4.13	4.45	4.41	5.03	5.41
		4.2	2.79	3.07	3.31	3.52	3.92	4.23	4.09	4.72	5.14
		4.8	2.67	2.94	3.17	3.29	3.75	4.04	3.82	4.41	4.92
		5.4	2.54	2.83	3.04	3.11	3.59	3.89	3.60	4.16	4.65
	No. 1 and No. 2	2.4	2.97	3.42	3.82	3.63	4.19	4.68	4.21	4.86	5.43
		3.0	2.65	3.06	3.42	3.24	3.75	4.19	3.76	4.35	4.86
		3.6	2.42	2.80	3.13	2.96	3.42	3.82	3.44	3.97	4.44
		4.2	2.24	2.59	2.89	2.74	3.17	3.54	3.18	3.67	4.11
		4.8	2.10	2.42	2.71	2.56	2.96	3.31	2.98	3.44	3.84
		5.4	1.98	2.28	2.55	2.42	2.79	3.12	2.81	3.24	3.62

		6.0	1.88	2.17	2.42	2.29	2.65	2.96	2.66	3.07	3.44
Hem – Fir (includes Western Hemlock and Amabilis Fir)	Select Structur al	2.4	3.32	3.65	3.93	4.24	4.66	5.03	5.16	5.61	5.93
		3.0	3.08	3.39	3.65	3.93	4.33	4.66	4.76	5.27	5.61
		3.6	2.90	3.19	3.44	3.70	4.08	4.39	4.35	4.96	5.34
		4.2	2.75	3.03	3.27	3.47	3.87	4.17	4.02	4.65	5.07
		4.8	2.63	2.90	3.12	3.24	3.70	3.99	3.66	4.35	4.85
		5.4	2.49	2.79	3.00	2.95	3.53	3.83	3.32	4.10	4.58
		6.0	2.28	2.69	2.90	2.70	3.35	3.70	3.04	3.87	4.35
	No. 1 and No. 2	2.4	3.11	3.55	3.82	3.80	4.39	4.88	4.41	5.10	5.70
		3.0	2.78	3.21	3.55	3.40	3.93	4.39	3.95	4.56	5.10
		3.6	2.54	2.93	3.28	3.11	3.59	4.01	3.60	4.16	4.65
		4.2	2.35	2.72	3.04	2.88	3.32	3.71	3.34	3.85	4.31
		4.8	2.20	2.54	2.84	2.69	3.11	3.47	3.12	3.60	4.03
		5.4	2.07	2.39	2.68	2.54	2.93	3.27	2.94	3.40	3.80
		6.0	1.97	2.27	2.54	2.41	2.78	3.11	2.79	3.22	3.60
Spruce – Pine – Fir (includes Spruce (all species except Coast Sitka Spruce), Jack Pine, Lodgepole Pine, Balsam Fir and Alpine Fir)	Select Structur al	2.4	3.17	3.49	3.76	4.05	4.46	4.81	4.93	5.42	5.73
		3.0	2.95	3.24	3.49	3.76	4.14	4.46	4.58	5.04	5.42
		3.6	2.77	3.05	3.29	3.54	3.90	4.20	4.31	4.74	5.11
		4.2	2.63	2.90	3.12	3.36	3.70	3.99	4.09	4.51	4.85
		4.8	2.52	2.77	2.99	3.22	3.54	3.81	3.82	4.31	4.64
		5.4	2.42	2.67	2.87	3.09	3.41	3.67	3.60	4.14	4.46
		6.0	2.34	2.57	2.77	2.95	3.29	3.54	3.32	3.95	4.31
	No. 1 and No. 2	2.4	3.07	3.38	3.64	3.92	4.32	4.65	4.57	5.25	5.59
		3.0	2.85	3.14	3.38	3.52	4.01	4.32	4.09	4.72	5.25
		3.6	2.63	2.95	3.18	3.22	3.71	4.06	3.73	4.31	4.82
		4.2	2.44	2.80	3.02	2.98	3.44	3.84	3.46	3.99	4.46
		4.8	2.28	2.63	2.89	2.79	3.22	3.60	3.23	3.73	4.17
		5.4	2.15	2.48	2.77	2.63	3.03	3.39	3.05	3.52	3.93
		6.0	2.04	2.35	2.63	2.49	2.88	3.22	2.89	3.34	3.73
Northern Species (includes any Canadian species covered by the NLGA Standard Grading Rules)	Select Structur al	2.4	2.84	3.12	3.36	3.62	3.99	4.30	4.33	4.85	5.23
		3.0	2.63	2.90	3.12	3.34	3.70	3.99	3.88	4.47	4.85
		3.6	2.48	2.73	2.94	3.05	3.48	3.75	3.54	4.08	4.57
		4.2	2.31	2.59	2.79	2.82	3.26	3.57	3.28	3.78	4.23
		4.8	2.16	2.48	2.67	2.64	3.05	3.41	3.06	3.54	3.96
		5.4	2.04	2.35	2.57	2.49	2.87	3.21	2.89	3.34	3.73
		6.0	1.93	2.23	2.48	2.36	2.73	3.05	2.74	3.16	3.54
		2.4	2.59	2.99	3.29	3.16	3.65	4.08	3.67	4.24	4.74

	No. 1 and No. 2	3.0	2.31	2.67	2.99	2.83	3.27	3.65	3.28	3.79	4.24
		3.6	2.11	2.44	2.73	2.58	2.98	3.33	3.00	3.46	3.87
		4.2	1.95	2.26	2.52	2.39	2.76	3.09	2.77	3.20	3.58
		4.8	1.83	2.11	2.36	2.24	2.58	2.89	2.59	3.00	3.35
		5.4	1.72	1.99	2.23	2.11	2.43	2.72	2.45	2.82	3.16
		6.0	1.64	1.89	2.11	2.00	2.31	2.58	2.32	2.68	3.00

**Notes to Table 9.23.4.2.-H:**

(1) Beam spans apply only where the floors serve residential areas as described in Table 4.1.5.3., or the uniformly distributed *live load* on the floors does not exceed that specified for residential areas as described in Table 4.1.5.3.

(2) When the floors have a concrete topping of not more than 51 mm, the spans must be multiplied by 0.8.

(3) Supported length means half the sum of the joist spans on both sides of the beam.

(4) Straight interpolation may be used for other supported lengths.

(5) Spans are clear spans between supports. For total span, add two bearing lengths.

(6) 3-ply beams with supported lengths greater than 4.2 m require 114 mm bearing. All other beams require 76 mm bearing.

**Table 9.23.4.2.-I**

**Maximum Spans for Built-up Floor Beams Supporting not more than Two Floors(1)(2)**

**Forming Part of Sentences 9.3.2.8.(1), 9.23.4.2.(3), 9.23.4.4.(3) and 9.23.8.1.(1)**

Commercial Designation	Grade	Supported Length, m <sup>(3)(4)</sup>	Maximum Span, m <sup>(5)(6)</sup>								
			Size of Built-up Beam, mm								
			3-38x18 4	4-38x18 4	5-38x18 4	3-38x23 5	4-38x23 5	5-38x23 5	3-38x28 6	4-38x28 6	5-38x28 6
Douglas Fir – Larch (includes Douglas Fir and Western Larch)	Select Structural	2.4	2.80	3.08	3.32	3.49	3.93	4.24	4.05	4.67	5.16
		3.0	2.55	2.86	3.08	3.12	3.60	3.93	3.62	4.18	4.67
		3.6	2.33	2.69	2.90	2.85	3.29	3.68	3.30	3.82	4.27
		4.2	2.16	2.49	2.75	2.64	3.04	3.40	2.99	3.53	3.95
		4.8	2.00	2.33	2.60	2.38	2.85	3.18	2.69	3.30	3.69
		5.4	1.82	2.20	2.45	2.17	2.68	3.00	2.45	3.08	3.48
		6.0	1.67	2.08	2.33	2.00	2.51	2.85	2.26	2.83	3.30
	No. 1 and No. 2	2.4	2.22	2.56	2.87	2.72	3.14	3.51	3.15	3.64	4.07
		3.0	1.99	2.29	2.56	2.43	2.80	3.14	2.82	3.25	3.64
		3.6	1.81	2.09	2.34	2.22	2.56	2.86	2.57	2.97	3.32
		4.2	1.68	1.94	2.17	2.05	2.37	2.65	2.38	2.75	3.07
		4.8	1.57	1.81	2.03	1.92	2.22	2.48	2.23	2.57	2.88
		5.4	1.48	1.71	1.91	1.81	2.09	2.34	2.10	2.43	2.71
		6.0	1.40	1.62	1.81	1.72	1.98	2.22	1.99	2.30	2.57
Hem – Fir (includes		2.4	2.76	3.04	3.27	3.43	3.88	4.18	3.99	4.60	5.09
		3.0	2.51	2.82	3.04	2.97	3.55	3.88	3.34	4.12	4.60



Western Hemlock and Amabilis Fir)	Select Structural	3.6	2.15	2.65	2.86	2.56	3.24	3.62	2.88	3.65	4.20
		4.2	1.90	2.40	2.72	2.26	2.85	3.35	2.55	3.21	3.87
		4.8	1.70	2.15	2.56	2.03	2.56	3.08	2.30	2.88	3.46
		5.4	1.56	1.95	2.35	1.86	2.32	2.79	2.11	2.62	3.14
		6.0	1.44	1.79	2.15	1.72	2.14	2.56	1.96	2.42	2.88
	No. 1 and No. 2	2.4	2.33	2.69	3.01	2.85	3.29	3.68	3.30	3.82	4.27
		3.0	2.08	2.41	2.69	2.55	2.94	3.29	2.96	3.41	3.82
		3.6	1.90	2.20	2.45	2.33	2.68	3.00	2.70	3.12	3.48
		4.2	1.76	2.03	2.27	2.15	2.49	2.78	2.50	2.88	3.22
		4.8	1.65	1.90	2.13	2.01	2.33	2.60	2.30	2.70	3.02
		5.4	1.55	1.79	2.00	1.86	2.19	2.45	2.11	2.54	2.84
	6.0	1.44	1.70	1.90	1.72	2.08	2.33	1.96	2.41	2.70	
	Spruce – Pine – Fir (includes Spruce (all species except Coast Sitka Spruce), Jack Pine, Lodgepole Pine, Balsam Fir and Alpine Fir)	Select Structural	2.4	2.64	2.91	3.13	3.37	3.71	4.00	4.05	4.52
3.0			2.45	2.70	2.91	3.12	3.45	3.71	3.62	4.18	4.52
3.6			2.31	2.54	2.73	2.79	3.24	3.49	3.14	3.82	4.25
4.2			2.07	2.41	2.60	2.46	3.04	3.32	2.77	3.50	3.95
4.8			1.85	2.31	2.48	2.21	2.79	3.17	2.50	3.14	3.69
5.4			1.69	2.13	2.39	2.02	2.53	3.00	2.28	2.85	3.42
6.0			1.56	1.95	2.31	1.86	2.32	2.79	2.11	2.62	3.14
No. 1 and No. 2		2.4	2.41	2.79	3.03	2.95	3.41	3.81	3.42	3.95	4.42
		3.0	2.16	2.49	2.79	2.64	3.05	3.41	3.06	3.53	3.95
		3.6	1.97	2.27	2.54	2.41	2.78	3.11	2.79	3.23	3.61
		4.2	1.82	2.11	2.35	2.23	2.57	2.88	2.59	2.99	3.34
		4.8	1.71	1.97	2.20	2.09	2.41	2.69	2.42	2.79	3.12
		5.4	1.61	1.86	2.08	1.97	2.27	2.54	2.28	2.63	2.95
6.0	1.53	1.76	1.97	1.86	2.15	2.41	2.11	2.50	2.79		
Northern Species (includes any Canadian species covered by the NLGA Standard Grading Rules)	Select Structural	2.4	2.29	2.60	2.80	2.80	3.23	3.57	3.24	3.75	4.19
		3.0	2.04	2.36	2.60	2.50	2.89	3.23	2.90	3.35	3.75
		3.6	1.87	2.16	2.41	2.28	2.64	2.95	2.65	3.06	3.42
		4.2	1.73	2.00	2.23	2.11	2.44	2.73	2.45	2.83	3.17
		4.8	1.62	1.87	2.09	1.98	2.28	2.55	2.29	2.65	2.96
		5.4	1.52	1.76	1.97	1.86	2.15	2.41	2.11	2.50	2.79
		6.0	1.44	1.67	1.87	1.72	2.04	2.28	1.96	2.37	2.65
	No. 1 and No. 2	2.4	1.94	2.24	2.50	2.37	2.73	3.06	2.75	3.17	3.55
		3.0	1.73	2.00	2.24	2.12	2.44	2.73	2.46	2.84	3.17
		3.6	1.58	1.83	2.04	1.93	2.23	2.50	2.24	2.59	2.90
		4.2	1.46	1.69	1.89	1.79	2.07	2.31	2.08	2.40	2.68

		4.8	1.37	1.58	1.77	1.67	1.93	2.16	1.94	2.24	2.51
		5.4	1.29	1.49	1.67	1.58	1.82	2.04	1.83	2.11	2.36
		6.0	1.22	1.41	1.58	1.50	1.73	1.93	1.74	2.01	2.24

**Notes to Table 9.23.4.2.-I:**

- (1) Beam spans apply only where the floors serve residential areas as described in Table 4.1.5.3., or the uniformly distributed *live load* on the floors does not exceed that specified for residential areas as described in Table 4.1.5.3.
- (2) When the floors have a concrete topping of not more than 51 mm, the spans must be multiplied by 0.8.
- (3) Supported length means half the sum of the joist spans on both sides of the beam.
- (4) Straight interpolation may be used for other supported lengths.
- (5) Spans are clear spans between supports. For total span, add two bearing lengths.
- (6) 3-ply beams require 114 mm bearing. 4-ply and 5-ply beams with supported lengths greater than 3 m require 114 mm bearing. All other beams require 76 mm bearing.

**Table 9.23.4.2.-J**

**Maximum Spans for Built-up Floor Beams Supporting not more than Three Floors(1)(2)  
Forming Part of Sentences 9.3.2.8.(1), 9.23.4.2.(3), 9.23.4.4.(3) and 9.23.8.1.(1)**

Commercial Designation	Grade	Supported Length, m <sup>(3)(4)</sup>	Maximum Span, m <sup>(5)(6)</sup>								
			Size of Built-up Beam, mm								
			3-38×18 4	4-38×18 4	5-38×18 4	3-38×23 5	4-38×23 5	5-38×23 5	3-38×28 6	4-38×28 6	5-38×28 6
Douglas Fir – Larch (includes Douglas Fir and Western Larch)	Select Structural	2.4	2.38	2.74	2.95	2.91	3.36	3.75	3.37	3.89	4.35
		3.0	2.13	2.46	2.74	2.60	3.00	3.36	2.92	3.48	3.89
		3.6	1.88	2.24	2.51	2.24	2.74	3.06	2.53	3.18	3.56
		4.2	1.66	2.08	2.32	1.99	2.49	2.84	2.25	2.81	3.29
		4.8	1.50	1.88	2.17	1.80	2.24	2.65	2.04	2.53	3.02
		5.4	1.38	1.71	2.05	1.65	2.04	2.44	1.88	2.31	2.75
		6.0	1.28	1.58	1.88	1.53	1.89	2.24	1.75	2.14	2.53
	No. 1 and No. 2	2.4	1.85	2.14	2.39	2.26	2.61	2.92	2.63	3.03	3.39
		3.0	1.66	1.91	2.14	2.02	2.34	2.61	2.35	2.71	3.03
		3.6	1.51	1.74	1.95	1.85	2.13	2.39	2.14	2.48	2.77
		4.2	1.40	1.62	1.81	1.71	1.98	2.21	1.99	2.29	2.56
		4.8	1.31	1.51	1.69	1.60	1.85	2.07	1.86	2.14	2.40
		5.4	1.23	1.42	1.59	1.51	1.74	1.95	1.75	2.02	2.26
Hem – Fir (includes Western Hemlock and Amabilis Fir)	Select Structural	2.4	2.22	2.70	2.91	2.64	3.31	3.70	2.98	3.78	4.29
		3.0	1.85	2.35	2.70	2.21	2.79	3.31	2.50	3.14	3.78
		3.6	1.61	2.02	2.43	1.92	2.40	2.89	2.18	2.71	3.24
		4.2	1.43	1.78	2.14	1.71	2.13	2.54	1.95	2.40	2.86
		4.8	1.30	1.61	1.92	1.56	1.92	2.28	1.77	2.18	2.58

		5.4	1.19	1.47	1.74	1.44	1.76	2.08	1.64	2.00	2.35
		6.0	1.11	1.36	1.61	1.34	1.63	1.92	1.53	1.85	2.18
	No. 1 and No. 2	2.4	1.94	2.24	2.51	2.37	2.74	3.06	2.75	3.18	3.56
		3.0	1.74	2.00	2.24	2.12	2.45	2.74	2.46	2.84	3.18
		3.6	1.58	1.83	2.05	1.92	2.24	2.50	2.18	2.60	2.90
		4.2	1.43	1.69	1.89	1.71	2.07	2.32	1.95	2.40	2.69
		4.8	1.30	1.58	1.77	1.56	1.92	2.17	1.77	2.18	2.51
		5.4	1.19	1.47	1.67	1.44	1.76	2.04	1.64	2.00	2.35
		6.0	1.11	1.36	1.58	1.34	1.63	1.92	1.53	1.85	2.18
Spruce – Pine – Fir (includes Spruce (all species except Coast Sitka Spruce), Jack Pine, Lodgepole Pine, Balsam Fir and Alpine Fir)	Select Structural	2.4	2.35	2.58	2.78	2.89	3.30	3.55	3.24	3.89	4.33
		3.0	2.02	2.40	2.58	2.40	3.00	3.30	2.71	3.42	3.89
		3.6	1.74	2.20	2.43	2.08	2.62	3.06	2.35	2.95	3.54
		4.2	1.55	1.94	2.31	1.85	2.31	2.77	2.10	2.61	3.12
		4.8	1.40	1.74	2.09	1.68	2.08	2.48	1.91	2.35	2.80
		5.4	1.28	1.59	1.90	1.54	1.90	2.26	1.76	2.16	2.55
		6.0	1.19	1.47	1.74	1.44	1.76	2.08	1.64	2.00	2.35
	No. 1 and No. 2	2.4	2.01	2.32	2.60	2.46	2.84	3.17	2.85	3.29	3.68
		3.0	1.80	2.08	2.32	2.20	2.54	2.84	2.55	2.95	3.29
		3.6	1.64	1.90	2.12	2.01	2.32	2.59	2.33	2.69	3.01
		4.2	1.52	1.75	1.96	1.85	2.15	2.40	2.10	2.49	2.78
		4.8	1.40	1.64	1.84	1.68	2.01	2.24	1.91	2.33	2.60
		5.4	1.28	1.55	1.73	1.54	1.89	2.12	1.76	2.16	2.46
Northern Species (includes any Canadian species covered by the NLGA Standard Grading Rules)	Select Structural	2.4	1.91	2.20	2.46	2.33	2.69	3.01	2.70	3.12	3.49
		3.0	1.70	1.97	2.20	2.08	2.41	2.69	2.42	2.79	3.12
		3.6	1.56	1.80	2.01	1.90	2.20	2.46	2.18	2.55	2.85
		4.2	1.43	1.66	1.86	1.71	2.03	2.27	1.95	2.36	2.64
		4.8	1.30	1.56	1.74	1.56	1.90	2.13	1.77	2.18	2.47
		5.4	1.19	1.47	1.64	1.44	1.76	2.01	1.64	2.00	2.33
		6.0	1.11	1.36	1.56	1.34	1.63	1.90	1.53	1.85	2.18
	No. 1 and No. 2	2.4	1.61	1.86	2.08	1.97	2.28	2.55	2.29	2.64	2.96
		3.0	1.44	1.67	1.86	1.76	2.04	2.28	2.05	2.36	2.64
		3.6	1.32	1.52	1.70	1.61	1.86	2.08	1.87	2.16	2.41
		4.2	1.22	1.41	1.57	1.49	1.72	1.93	1.73	2.00	2.23
		4.8	1.14	1.32	1.47	1.40	1.61	1.80	1.62	1.87	2.09
		5.4	1.08	1.24	1.39	1.32	1.52	1.70	1.53	1.76	1.97
6.0	1.02	1.18	1.32	1.25	1.44	1.61	1.45	1.67	1.87		

Notes to Table 9.23.4.2.-J:

<sup>(1)</sup> Beam spans apply only where the floors serve residential areas as described in Table 4.1.5.3., or the uniformly distributed *live load* on the floors does not exceed that specified for residential areas as described in Table 4.1.5.3.

<sup>(2)</sup> When the floors have a concrete topping of not more than 51 mm, the spans must be multiplied by 0.8.

<sup>(3)</sup> Supported length means half the sum of the joist spans on both sides of the beam.

<sup>(4)</sup> Straight interpolation may be used for other supported lengths.

<sup>(5)</sup> Spans are clear spans between supports. For total span, add two bearing lengths.

<sup>(6)</sup> 3-ply beams with supported lengths greater than 4.2 m require 152 mm bearing. All other beams require 114 mm bearing.

**Table 9.23.4.2.-K**

**Maximum Spans for Glued-Laminated Floor Beams – 20f-E Grade(1)**

**Forming Part of Sentences 9.3.2.8.(1), 9.23.4.2.(3), 9.23.4.4.(3) and 9.23.8.1.(1)**

Number of Storeys Supported	Beam Width, mm	Supported Length, m <sup>(2)(3)</sup>	Maximum Span, m <sup>(4)(5)(6)(7)</sup>						
			Beam Depth, mm						
			228	266	304	342	380	418	456
1	80	2.4	4.32	5.04	5.76	6.48	7.20	7.92	8.64
		3.0	3.87	4.51	5.15	5.80	6.44	7.09	7.73
		3.6	3.53	4.12	4.70	5.29	5.88	6.47	7.06
		4.2	3.27	3.81	4.36	4.90	5.44	5.99	6.53
		4.8	3.06	3.57	4.07	4.58	5.09	5.60	6.11
		5.4	2.88	3.36	3.84	4.32	4.80	5.28	5.76
		6.0	2.73	3.19	3.64	4.10	4.56	5.01	5.47
	130	2.4	5.51	6.43	7.35	8.26	9.18	10.10	11.02
		3.0	4.93	5.75	6.57	7.39	8.21	9.03	9.86
		3.6	4.50	5.25	6.00	6.75	7.50	8.25	9.00
		4.2	4.16	4.86	5.55	6.25	6.94	7.64	8.33
		4.8	3.90	4.54	5.19	5.84	6.49	7.14	7.79
		5.4	3.67	4.28	4.90	5.51	6.12	6.73	7.35
		6.0	3.48	4.07	4.65	5.23	5.81	6.39	6.97
2	80	2.4	3.28	3.83	4.37	4.92	5.47	6.01	6.56
		3.0	2.93	3.42	3.91	4.40	4.89	5.38	5.87
		3.6	2.68	3.12	3.57	4.02	4.46	4.91	5.36
		4.2	2.48	2.89	3.31	3.72	4.13	4.54	4.96
		4.8	2.32	2.71	3.09	3.48	3.86	4.25	4.64
		5.4	2.19	2.55	2.91	3.28	3.64	4.01	4.37
		6.0	2.07	2.42	2.77	3.11	3.46	3.80	4.15
	130	2.4	4.18	4.88	5.57	6.27	6.97	7.66	8.36
		3.0	3.74	4.36	4.99	5.61	6.23	6.85	7.48
		3.6	3.41	3.98	4.55	5.12	5.69	6.26	6.83

3		4.2	3.16	3.69	4.21	4.74	5.27	5.79	6.32
		4.8	2.96	3.45	3.94	4.43	4.93	5.42	5.91
		5.4	2.79	3.25	3.72	4.18	4.64	5.11	5.57
		6.0	2.64	3.08	3.53	3.97	4.41	4.85	5.29
	80	2.4	2.75	3.21	3.66	4.12	4.58	5.04	5.50
		3.0	2.46	2.87	3.28	3.69	4.10	4.51	4.92
		3.6	2.24	2.62	2.99	3.37	3.74	4.11	4.49
		4.2	2.08	2.42	2.77	3.12	3.46	3.81	4.15
		4.8	1.94	2.27	2.59	2.91	3.24	3.56	3.89
		5.4	1.83	2.14	2.44	2.75	3.05	3.36	3.66
		6.0	1.74	2.03	2.32	2.61	2.90	3.19	3.48
		130	2.4	3.50	4.09	4.67	5.25	5.84	6.42
	3.0		3.13	3.66	4.18	4.70	5.22	5.74	6.27
	3.6		2.86	3.34	3.81	4.29	4.77	5.24	5.72
	4.2		2.65	3.09	3.53	3.97	4.41	4.85	5.30
	4.8		2.48	2.89	3.30	3.72	4.13	4.54	4.95
5.4	2.34		2.72	3.11	3.50	3.89	4.28	4.67	
6.0	2.22		2.58	2.95	3.32	3.69	4.06	4.43	

**Notes to Table 9.23.4.2.-K:**

<sup>(1)</sup> Spans apply only where the floors serve residential areas as described in Table 4.1.5.3., or the uniformly distributed *live load* on the floors does not exceed that specified for residential areas as described in Table 4.1.5.3.

<sup>(2)</sup> Supported length means half the sum of the joist spans on both sides of the beam.

<sup>(3)</sup> Straight interpolation may be used for other supported lengths.

<sup>(4)</sup> Spans are valid for glued-laminated timber conforming to CAN/CSA-O122 and CSA O177.

<sup>(5)</sup> Spans are clear spans between supports. For total span, add two bearing lengths.

<sup>(6)</sup> Provide a minimum bearing length of 89 mm. (Alternatively, the bearing length may be designed in accordance with Part 4.)

<sup>(7)</sup> Top edge of beam assumed to be fully laterally supported by joists.

**Table 9.23.4.2.-L**

**Maximum Spans for Built-up Ridge Beams and Lintels Supporting the Roof and Ceiling Only, No. 1 or No. 2 Grade**

**Forming Part of Sentences 9.3.2.8.(1), 9.23.4.2.(4), 9.23.4.5.(1), 9.23.12.3.(1) and (3), and 9.23.14.10.(2)**

Commercial Designation	Beam or Lintel Size, mm	Maximum Span, m <sup>(1)(2)(3)</sup>				
		Specified Snow Load, kPa				
		1.0	1.5	2.0	2.5	3.0
Douglas Fir – Larch (includes Douglas Fir and Western Larch)	3-38×184	2.65	2.28	2.03	1.85	1.71
	4-38×184	3.06	2.64	2.35	2.14	1.97
	5-38×184	3.43	2.95	2.62	2.39	2.21

	3-38×235	3.25	2.79	2.49	2.26	2.09
	4-38×235	3.75	3.22	2.87	2.61	2.41
	5-38×235	4.19	3.60	3.21	2.92	2.70
	3-38×286	3.77	3.24	2.88	2.62	2.43
	4-38×286	4.35	3.74	3.33	3.03	2.80
	5-38×286	4.86	4.18	3.72	3.39	3.13
Hem – Fir (includes Western Hemlock and Amabilis Fir)	3-38×184	2.78	2.39	2.13	1.94	1.79
	4-38×184	3.21	2.76	2.46	2.24	2.07
	5-38×184	3.59	3.09	2.75	2.50	2.31
	3-38×235	3.40	2.93	2.61	2.37	2.19
	4-38×235	3.93	3.38	3.01	2.74	2.53
	5-38×235	4.39	3.78	3.36	3.06	2.83
	3-38×286	3.95	3.40	3.02	2.75	2.54
	4-38×286	4.56	3.92	3.49	3.18	2.94
Spruce – Pine – Fir (includes Spruce (all species except Coast Sitka Spruce) Jack Pine, Lodgepole Pine, Balsam Fir and Alpine Fir)	3-38×184	2.88	2.48	2.21	2.01	1.86
	4-38×184	3.30	2.86	2.55	2.32	2.14
	5-38×184	3.55	3.10	2.82	2.59	2.40
	3-38×235	3.53	3.03	2.70	2.46	2.27
	4-38×235	4.07	3.50	3.12	2.84	2.62
	5-38×235	4.54	3.91	3.49	3.17	2.93
	3-38×286	4.09	3.52	3.13	2.85	2.63
	4-38×286	4.72	4.06	3.62	3.29	3.04
	5-38×286	5.28	4.54	4.04	3.68	3.40

**Notes to Table 9.23.4.2.-L:**

<sup>(1)</sup> Beam and lintel spans are calculated based on a maximum supported length of 4.9 m. Spans may be increased by 5% for supported lengths of not more than 4.3 m, by 10% for supported lengths of not more than 3.7 m, and by 25% for supported lengths of not more than 2.4 m.

<sup>(2)</sup> For ridge beams, supported length means half the sum of the rafter, joist or truss spans on both sides of the beam. For lintels, supported length means half the sum of truss, roof joist or rafter spans supported by the lintel plus the length of the overhang beyond the lintel.

<sup>(3)</sup> Provide minimum 76 mm bearing.

**Table 9.23.12.3.-A**

**Maximum Spans for Douglas Fir – Larch Lintels – No. 1 or No. 2 Grade – Non-structural Sheathing(1)**

**Forming Part of Sentences 9.3.2.8.(1), 9.23.4.5.(1) and 9.23.12.3.(1) and (3)**

Lintel Supporting	Lintel Size, <sup>(2)</sup> mm	Maximum Span, m <sup>(3)(4)</sup>	
		Exterior Walls	Interior Walls
		Specified Snow Load, kPa	

		1.0	1.5	2.0	2.5	3.0	
Limited attic storage and ceiling	2-38×89	This Area Intentionally Left Blank					1.25
	2-38×140	This Area Intentionally Left Blank					1.78
	2-38×184	This Area Intentionally Left Blank					2.17
	2-38×235	This Area Intentionally Left Blank					2.65
	2-38×286	This Area Intentionally Left Blank					3.08
Roof and ceiling only (tributary width of 0.6 m maximum) <sup>(5)</sup>	2-38×89	2.68	2.34	2.13	1.97	1.86	1.97
	2-38×140	4.21	3.68	3.34	3.10	2.92	3.10
	2-38×184	5.50	4.84	4.39	4.08	3.84	4.08
	2-38×235	6.61	5.97	5.56	5.21	4.88	5.21
	2-38×286	7.66	6.92	6.44	6.09	5.66	6.09
Roof and ceiling only (tributary width of 4.9 m maximum) <sup>(6)</sup>	2-38×89	1.25	1.07	0.96	0.87	0.80	0.87
	2-38×140	1.78	1.53	1.36	1.24	1.15	1.24
	2-38×184	2.17	1.86	1.66	1.51	1.40	1.51
	2-38×235	2.65	2.28	2.03	1.85	1.71	1.85
	2-38×286	3.08	2.64	2.35	2.14	1.98	2.14
Roof, ceiling and 1 storey <sup>(3)(6)(7)</sup>	2-38×89	0.96	0.88	0.82	0.77	0.73	0.68
	2-38×140	1.37	1.26	1.17	1.10	1.04	0.97
	2-38×184	1.67	1.53	1.42	1.34	1.26	1.18
	2-38×235	2.04	1.88	1.74	1.63	1.54	1.44
	2-38×286	2.37	2.18	2.02	1.90	1.79	1.67
Roof, ceiling and 2 storeys <sup>(3)(6)(7)</sup>	2-38×89	0.86	0.81	0.77	0.73	0.70	0.61
	2-38×140	1.23	1.16	1.09	1.04	0.99	0.87
	2-38×184	1.50	1.41	1.33	1.27	1.21	1.06
	2-38×235	1.84	1.72	1.63	1.55	1.48	1.30
	2-38×286	2.13	2.00	1.89	1.80	1.72	1.51
Roof, ceiling and 3 storeys <sup>(3)(6)(7)</sup>	2-38×89	0.81	0.77	0.73	0.71	0.68	0.57
	2-38×140	1.15	1.10	1.05	1.01	0.97	0.82
	2-38×184	1.40	1.33	1.28	1.22	1.18	1.00
	2-38×235	1.71	1.63	1.56	1.50	1.44	1.22
	2-38×286	1.99	1.89	1.81	1.74	1.67	1.41

**Notes to Table 9.23.12.3.-A:**

<sup>(1)</sup> Where structural sheathing is used, lintel spans may be increased by 15%. Structural sheathing consists of a minimum 9.5 mm thick structural panel conforming to CSA O121, CSA O151, CSA O325 or CSA O437.0 fastened with at least two rows of fasteners to the exterior face of the lintel, and a single row to the top plates and studs. Fasteners shall conform to Table 9.23.3.5.-A.

<sup>(2)</sup> A single piece of 89 mm thick lumber may be used in lieu of 2 pieces of 38 mm thick lumber on edge.

<sup>(3)</sup> If floor joists span the full width of the *building* without support, lintel spans shall be reduced by 15% for “roof, ceiling and 1 storey,” by 20% for “roof, ceiling and 2 storeys,” and by 25% for “roof, ceiling and 3 storeys.”

- <sup>(4)</sup> For ends of lintels fully supported by walls, provide minimum 38 mm bearing for lintel spans up to 3 m, or minimum 76 mm bearing for lintel spans greater than 3 m.
- <sup>(5)</sup> Spans for 0.6 m tributary width are calculated for lintels in end walls that support only a 0.6 m width of roof and ceiling, but do not support roof joists, roof rafters or roof trusses.
- <sup>(6)</sup> Lintel spans are calculated based on a maximum floor joist, roof joist or rafter span of 4.9 m and a maximum roof truss span of 9.8 m. Lintel spans may be increased by 5% if rafter and joist spans are no greater than 4.3 m and roof truss spans are no greater than 8.6 m. Spans may be increased by 10% if rafter and joist spans are no greater than 3.7 m and roof truss spans are no greater than 7.4 m.
- <sup>(7)</sup> Spans apply only where the floors serve residential areas as described in Table 4.1.5.3., or the uniformly distributed *live load* does not exceed that specified for residential areas as described in Table 4.1.5.3.

**Table 9.23.12.3.-B**

**Maximum Spans for Hem – Fir Lintels – No. 1 or No. 2 Grade – Non-structural Sheathing(1)**

**Forming Part of Sentences 9.3.2.8.(1), 9.23.4.5.(1) and 9.23.12.3.(1) and (3)**

Lintel Supporting	Lintel Size, <sup>(2)</sup> mm	Maximum Span, m <sup>(3)(4)</sup>						Interior Walls
		Exterior Walls						
		Specified Snow Load, kPa						
		1.0	1.5	2.0	2.5	3.0		
Limited attic storage and ceiling	2-38×89	This Area Intentionally Left Blank						1.31
	2-38×140							1.87
	2-38×184							2.27
	2-38×235							2.78
	2-38×286							3.23
Roof and ceiling only (tributary width of 0.6 m maximum) <sup>(5)</sup>	2-38×89	2.68	2.34	2.13	1.97	1.86	1.97	
	2-38×140	4.21	3.68	3.34	3.10	2.92	3.10	
	2-38×184	5.50	4.84	4.39	4.08	3.84	4.08	
	2-38×235	6.61	5.97	5.56	5.21	4.90	5.21	
	2-38×286	7.66	6.92	6.44	6.09	5.82	6.09	
Roof and ceiling only (tributary width of 4.9 m maximum) <sup>(6)</sup>	2-38×89	1.31	1.13	1.00	0.91	0.84	0.91	
	2-38×140	1.87	1.61	1.43	1.30	1.20	1.30	
	2-38×184	2.27	1.95	1.74	1.58	1.42	1.58	
	2-38×235	2.78	2.39	2.13	1.92	1.71	1.92	
	2-38×286	3.23	2.77	2.47	2.17	1.94	2.17	
Roof, ceiling and 1 storey <sup>(3)(6)(7)</sup>	2-38×89	1.01	0.93	0.86	0.81	0.76	0.69	
	2-38×140	1.44	1.32	1.23	1.14	1.05	0.95	
	2-38×184	1.75	1.61	1.47	1.34	1.23	1.12	
	2-38×235	2.14	1.96	1.76	1.60	1.48	1.35	
	2-38×286	2.49	2.22	2.00	1.82	1.69	1.55	
	2-38×89	0.91	0.85	0.80	0.76	0.72	0.60	



Roof, ceiling and 2 storeys <sup>(3)(6)(7)</sup>	2-38×140	1.29	1.21	1.13	1.05	0.98	0.82
	2-38×184	1.57	1.44	1.33	1.24	1.16	0.98
	2-38×235	1.90	1.73	1.60	1.49	1.40	1.19
	2-38×286	2.15	1.97	1.82	1.70	1.60	1.37
Roof, ceiling and 3 storeys <sup>(3)(6)(7)</sup>	2-38×89	0.85	0.81	0.77	0.74	0.69	0.55
	2-38×140	1.21	1.14	1.06	1.00	0.95	0.76
	2-38×184	1.43	1.33	1.25	1.18	1.12	0.91
	2-38×235	1.72	1.60	1.50	1.42	1.35	1.10
	2-38×286	1.95	1.82	1.72	1.63	1.55	1.27

**Notes to Table 9.23.12.3.-B:**

<sup>(1)</sup> Where structural sheathing is used, lintel spans may be increased by 15%. Structural sheathing consists of a minimum 9.5 mm thick structural panel conforming to CSA O121, CSA O151, CSA O325 or CSA O437.0 fastened with at least two rows of fasteners to the exterior face of the lintel, and a single row to the top plates and studs. Fasteners shall conform to Table 9.23.3.5.-A.

<sup>(2)</sup> A single piece of 89 mm thick lumber may be used in lieu of 2 pieces of 38 mm thick lumber on edge.

<sup>(3)</sup> If floor joists span the full width of the *building* without support, lintel spans shall be reduced by 15% for “roof, ceiling and 1 storey,” by 20% for “roof, ceiling and 2 storeys,” and by 25% for “roof, ceiling and 3 storeys.”

<sup>(4)</sup> For ends of lintels fully supported by walls, provide minimum 38 mm bearing for lintel spans up to 3 m, or minimum 76 mm bearing for lintel spans greater than 3 m.

<sup>(5)</sup> Spans for 0.6 m tributary width are calculated for lintels in end walls that support only a 0.6 m width of roof and ceiling, but do not support roof joists, roof rafters or roof trusses.

<sup>(6)</sup> Lintel spans are calculated based on a maximum floor joist, roof joist or rafter span of 4.9 m and a maximum roof truss span of 9.8 m. Lintel spans may be increased by 5% if rafter and joist spans are no greater than 4.3 m and roof truss spans are no greater than 8.6 m. Spans may be increased by 10% if rafter and joist spans are no greater than 3.7 m and roof truss spans are no greater than 7.4 m.

<sup>(7)</sup> Spans apply only where the floors serve residential areas as described in Table 4.1.5.3., or the uniformly distributed *live load* does not exceed that specified for residential areas as described in Table 4.1.5.3.

**Table 9.23.12.3.-C**

**Maximum Spans for Spruce – Pine – Fir Lintels – No. 1 or No. 2 Grade – Non-structural Sheathing(1)**

**Forming Part of Sentences 9.3.2.8.(1), 9.23.4.5.(1) and 9.23.12.3.(1) and (3)**

Lintel Supporting	Lintel Size, <sup>(2)</sup> mm	Maximum Span, m <sup>(3)(4)</sup>						Interior Walls
		Exterior Walls						
		Specified Snow Load, kPa						
		1.0	1.5	2.0	2.5	3.0		
Limited attic storage and ceiling	2-38×89	This Area Intentionally Left Blank						1.27
	2-38×140							1.93
	2-38×184							2.35
	2-38×235							2.88
	2-38×286							3.34
Roof and ceiling only	2-38×89	2.55	2.23	2.02	1.88	1.77	1.88	
	2-38×140	4.01	3.50	3.18	2.96	2.78	2.96	

(tributary width of 0.6 m maximum) <sup>(5)</sup>	2-38×184	5.27	4.61	4.18	3.88	3.66	3.88
	2-38×235	6.37	5.76	5.34	4.96	4.67	4.96
	2-38×286	7.38	6.67	6.21	5.87	5.61	5.87
Roof and ceiling only (tributary width of 4.9 m maximum) <sup>(6)</sup>	2-38×89	1.27	1.11	1.01	0.93	0.87	0.93
	2-38×140	1.93	1.66	1.48	1.35	1.25	1.35
	2-38×184	2.35	2.02	1.80	1.64	1.52	1.64
	2-38×235	2.88	2.47	2.20	2.01	1.84	2.01
	2-38×286	3.34	2.87	2.56	2.33	2.09	2.33
Roof, ceiling and 1 storey <sup>(3)(6)(7)</sup>	2-38×89	1.05	0.96	0.89	0.84	0.79	0.74
	2-38×140	1.49	1.37	1.27	1.19	1.13	1.02
	2-38×184	1.82	1.67	1.55	1.44	1.33	1.20
	2-38×235	2.22	2.04	1.89	1.73	1.59	1.45
	2-38×286	2.58	2.36	2.15	1.96	1.81	1.66
Roof, ceiling and 2 storeys <sup>(3)(6)(7)</sup>	2-38×89	0.94	0.88	0.83	0.79	0.76	0.64
	2-38×140	1.34	1.26	1.19	1.13	1.06	0.88
	2-38×184	1.63	1.53	1.44	1.33	1.25	1.05
	2-38×235	1.99	1.87	1.72	1.60	1.50	1.27
	2-38×286	2.31	2.12	1.96	1.82	1.71	1.45
Roof, ceiling and 3 storeys <sup>(3)(6)(7)</sup>	2-38×89	0.88	0.83	0.80	0.77	0.74	0.59
	2-38×140	1.25	1.19	1.14	1.08	1.02	0.81
	2-38×184	1.52	1.44	1.35	1.27	1.21	0.97
	2-38×235	1.86	1.73	1.62	1.53	1.45	1.17
	2-38×286	2.11	1.96	1.84	1.74	1.66	1.35

**Notes to Table 9.23.12.3.-C:**

<sup>(1)</sup> Where structural sheathing is used, lintel spans may be increased by 15%. Structural sheathing consists of a minimum 9.5 mm thick structural panel conforming to CSA O121, CSA O151, CSA O325 or CSA O437.0 fastened with at least two rows of fasteners to the exterior face of the lintel, and a single row to the top plates and studs. Fasteners shall conform to Table 9.23.3.5.-A.

<sup>(2)</sup> A single piece of 89 mm thick lumber may be used in lieu of 2 pieces of 38 mm thick lumber on edge.

<sup>(3)</sup> If floor joists span the full width of the *building* without support, lintel spans shall be reduced by 15% for “roof, ceiling and 1 storey,” by 20% for “roof, ceiling and 2 storeys,” and by 25% for “roof, ceiling and 3 storeys.”

<sup>(4)</sup> For ends of lintels fully supported by walls, provide minimum 38 mm bearing for lintel spans up to 3 m, or minimum 76 mm bearing for lintel spans greater than 3 m.

<sup>(5)</sup> Spans for 0.6 m tributary width are calculated for lintels in end walls that support only a 0.6 m width of roof and ceiling, but do not support roof joists, roof rafters or roof trusses.

<sup>(6)</sup> Lintel spans are calculated based on a maximum floor joist, roof joist or rafter span of 4.9 m and a maximum roof truss span of 9.8 m. Lintel spans may be increased by 5% if rafter and joist spans are no greater than 4.3 m and roof truss spans are no greater than 8.6 m. Spans may be increased by 10% if rafter and joist spans are no greater than 3.7 m and roof truss spans are no greater than 7.4 m.

<sup>(7)</sup> Spans apply only where the floors serve residential areas as described in Table 4.1.5.3., or the uniformly distributed *live load* does not exceed that specified for residential areas as described in Table 4.1.5.3.

**Table 9.23.12.3.-D**

**Maximum Spans for Glued-Laminated Timber Lintels – 20f-E Stress Grade – Exterior Walls – Roof and Ceiling Load Only**

**Forming Part of Sentences 9.3.2.8.(1), 9.23.4.5.(1) and 9.23.12.3.(1) and (3)**

Lintel Size, mm	Maximum Span, m <sup>(1)(2)(3)</sup>														
	Specified Snow Load, kPa														
	1.0			1.5			2.0			2.5			3.0		
	Supported length, m <sup>(4)(5)</sup>			Supported length, m <sup>(4)(5)</sup>			Supported length, m <sup>(4)(5)</sup>			Supported length, m <sup>(4)(5)</sup>			Supported length, m <sup>(4)(5)</sup>		
	2.4	3.6	4.8	2.4	3.6	4.8	2.4	3.6	4.8	2.4	3.6	4.8	2.4	3.6	4.8
130 × 304	6.23	5.63	5.24	5.63	5.09	4.73	5.24	4.73	4.40	4.95	4.48	4.17	4.73	4.28	3.87
80 × 380	6.52	5.89	5.48	5.89	5.32	4.96	5.48	4.96	4.52	5.19	4.69	4.11	4.96	4.39	3.80
130 × 342	6.80	6.15	5.72	6.15	5.56	5.17	5.72	5.17	4.81	5.41	4.89	4.55	5.17	4.67	4.35
80 × 418	7.00	6.33	5.89	6.33	5.72	5.32	5.89	5.32	4.96	5.57	5.03	4.52	5.32	4.81	4.18
130 × 380	7.36	6.65	6.19	6.65	6.01	5.59	6.19	5.59	5.21	5.86	5.29	4.92	5.59	5.06	4.70
80 × 456	7.48	6.76	6.29	6.76	6.10	5.68	6.29	5.68	5.29	5.95	5.37	4.93	5.68	5.13	4.56
130 × 418	7.91	7.15	6.65	7.15	6.46	6.01	6.65	6.01	5.59	6.29	5.68	5.29	6.01	5.43	5.05
80 × 494	7.94	7.17	6.68	7.17	6.48	6.03	6.68	6.03	5.61	6.31	5.71	5.31	6.03	5.45	4.94
80 × 532	8.39	7.58	7.06	7.58	6.85	6.38	7.06	6.38	5.93	6.67	6.03	5.61	6.38	5.76	5.32
130 × 456	8.44	7.63	7.10	7.63	6.89	6.41	7.10	6.41	5.97	6.71	6.07	5.65	6.41	5.80	5.39

**Notes to Table 9.23.12.3.-D:**

- <sup>(1)</sup> Spans are valid for glued-laminated timber conforming to CAN/CSA-O122 and CSA O177.
- <sup>(2)</sup> Provide minimum 89 mm bearing. (Alternatively, the bearing length may be calculated in accordance with Part 4.)
- <sup>(3)</sup> Top edge of lintel assumed to be fully laterally supported.
- <sup>(4)</sup> Supported length means half the length of trusses or rafters, plus the length of the overhang beyond the wall.
- <sup>(5)</sup> For intermediate supported lengths, straight interpolation may be used.

# Notes to Part 9

## Housing and Small Buildings

**A-9.1.1.1.(1) Application of Part 9 to Seasonally and Intermittently Occupied Buildings.** The By-law does not provide separate requirements which would apply to seasonally or intermittently occupied buildings. Without compromising the basic health and safety provisions, however, various requirements in Part 9 recognize that leniency may be appropriate in some circumstances. With greater use of “cottages” through the winter months, the proliferation of seasonally occupied multiple-dwelling buildings and the increasing installation of modern conveniences in these buildings, the number and extent of possible exceptions is reduced.

### Energy Efficiency

Clause 9.36.1.3.(5)(b) exempts seasonally occupied residential buildings such as summer cottages from the requirements of Section 9.36. Cottages intended for continuous or regular winter use such as ski cabins are required to conform to Section 9.36.

### Thermal Insulation

Article 9.25.2.1. specifies that insulation is to be installed in walls, ceilings and floors which separate heated space from unheated space. Cottages intended for use only in the summer and which, therefore, have no space heating appliances, would not be required to be insulated. Should a heating system be installed at some later date, insulation should also be installed at that time in accordance with Article 9.25.1.1. and the insulation tables in Part 10. However, if the building were not intended for continuous or regular winter use, it may still be exempted from the remainder of the energy efficiency requirements in Part 10.

### Air Barrier Systems and Vapour Barriers

Articles 9.25.3.1. and 9.25.4.1. require the installation of air barrier systems and vapour barriers only where insulation is installed. Dwellings with no heating system would thus be exempt from these requirements. In some cases, seasonally occupied buildings that are conditioned may be required to conform to the air and vapour barrier requirements of Section 9.25, but not to the air barrier and other requirements of Part 10.

### Interior Wall and Ceiling Finishes

The choice of interior wall and ceiling finishes has implications for fire safety. Where a dwelling is a detached building, there are no fire resistance requirements for the walls or ceilings within the dwelling. The exposed surfaces of walls and ceilings are required to have a flame-spread rating not greater than 150 ( Subsection 9.10.17.). There is, therefore, considerable flexibility, even in continuously occupied dwellings, with respect to the materials used to finish these walls. Except where waterproof finishes are required (Subsection 9.29.2.), ceilings and walls may be left unfinished. Where two units adjoin, however, additional fire resistance requirements may apply to interior loadbearing walls, floors and the shared wall ( Article 9.10.8.3., and Subsections 9.10.9. and 9.10.11.).

### Plumbing and Electrical Facilities

Plumbing fixtures are required only where a piped water supply is available ( Subsection 9.31.4.), and electrical facilities only where electrical services are available ( Article 9.34.1.2.).

**A-9.3.1.7. Ratio of Water to Cementing Material.** While adding water to concrete on site may facilitate its distribution through formwork, this practice can have several undesirable results,

such as reduced strength, greater porosity, and more propensity to shrinkage cracking. The ratio of water to cementing material is determined according to weight. For example, using Table 9.3.1.7., the maximum water-cement ratio of 0.45 for a 20 mm coarse aggregate would require 18 kg (or 18 L) of water (1 L of water weighs 1 kg).

**A-9.3.2.1.(1) Grade Marking of Lumber.** Lumber is generally grouped for marketing into the species combinations contained in Table A-9.3.2.1.(1)-A. The maximum allowable spans for those combinations are listed in the span tables for joists, rafters and beams. Some species of lumber are also marketed individually. Since the allowable span for the northern species combination is based on the weakest species in the combination, the use of the span for this combination is permitted for any individual species not included in the Spruce-Pine-Fir, Douglas Fir-Larch and Hemlock-Fir combinations.

Facsimiles of typical grade marks of lumber associations and grading agencies accredited by the Canadian Lumber Standards (CLS) Accreditation Board to grade mark lumber in Canada are shown in Table A-9.3.2.1.(1)-B. Accreditation by the CLS Accreditation Board applies to the inspection, grading and grade marking of lumber, including mill supervisory service, in accordance with CSA O141, "Softwood Lumber."

The grade mark of a CLS accredited agency on a piece of lumber indicates its assigned grade, species or species combination, moisture condition at the time of surfacing, the responsible grader or mill of origin and the CLS accredited agency under whose supervision the grading and marking was done.

Table A-9.3.2.1.(1)-A

Species Designations and Abbreviations

Commercial Designation of Species or Species Combination	Abbreviation Permitted on Grade Stamps	Species Included
Douglas Fir – Larch	D Fir – L (N)	Douglas Fir, Western Larch
Hemlock – Fir	Hem – Fir (N)	Western Hemlock, Amabilis Fir
Spruce – Pine – Fir	S – P – F or Spruce – Pine – Fir	White Spruce, Engelmann Spruce, Black Spruce, Red Spruce, Lodgepole Pine, Jack Pine, Alpine Fir, Balsam Fir
Northern Species	North Species	Any Canadian softwood covered by the "Standard Grading Rules for Canadian Lumber"




Canadian lumber is graded to the "Standard Grading Rules for Canadian Lumber," published by the National Lumber Grades Authority. These rules specify standard grade names and grade name abbreviations for use in grade marks to provide positive identification of lumber grades. In a similar fashion, standard species names or standard species abbreviations, symbols or marks are provided in the rules for use in grade marks.




Grade marks denote the moisture content of lumber at the time of surfacing. "S-Dry" in the mark indicates the lumber was surfaced at a moisture content not exceeding 19%. "MC 15" indicates a moisture content not exceeding 15%. "S-GRN" in the grade mark signifies that the lumber was surfaced at a moisture content higher than 19% at a size to allow for natural shrinkage during seasoning.

Each mill or grader is assigned a permanent number. The point of origin of lumber is identified in the grade mark by use of a mill or grader number or by the mill name or abbreviation. The CLS certified agency under whose supervision the lumber was grade marked is identified in the mark by the registered symbol of the agency.

Table A-9.3.2.1.(1)-B

**Facsimiles of Grade Marks Used by Canadian Lumber Manufacturing Associations and Agencies Authorized to Grade Mark Lumber in Canada**

Facsimiles of Grade Mark	Association or Agency
<p align="center"> <b>A.F.P.A.<sup>®</sup> 00</b>  <b>S-P-F NLGA</b>  <b>KD-HT</b> </p> <p align="right" style="font-size: 2em;"><b>1</b></p> <p align="center"><small>GG0005E</small></p>	<p>Alberta Forest Products Association  <a href="http://www.albertaforestproducts.ca">www.albertaforestproducts.ca</a></p>
<p align="center">  <b>No 1</b>  <b>KD-HT</b>  <b>NLGA</b>  <b>S-P-F</b> </p> <p align="center"><small>GG0006B</small></p>	<p>Canadian Mill Services Association  <a href="http://www.canserve.org">www.canserve.org</a></p>
<p align="center"> <b>CSI</b> <b>No.1</b>  <b>00</b> <b>KD-HT</b>  <b>NLGA</b> <b>D FIR-L (N)</b> </p> <p align="center"><small>GG0006A</small></p>	<p>Canadian Softwood Inspection Agency Inc.  <a href="http://www.canadiansoftwood.com">www.canadiansoftwood.com</a></p>
<p align="center"> <b>CFPA<sup>®</sup> 26</b>  <b>S-P-F</b>  <b>KD-HT</b>  <b>NLGA</b> </p> <p align="right" style="font-size: 2em;"><b>2</b></p> <p align="center"><small>GG0006E</small></p>	<p>Central Forest Products Association Inc.  <a href="http://www.cfpa-lumber.com">www.cfpa-lumber.com</a></p>
<p align="center">  <b>KD-HT</b>  <b>91</b> <b>1</b>  <b>NLGA</b> <b>S-P-F</b> </p> <p align="center">  <b>KD-HT</b>  <b>25</b> <b>1</b>  <b>NLGA</b> <b>D FIR-L(N)</b> </p> <p align="center"><small>GG0007B</small></p>	<p>Council of Forest Industries  <a href="http://www.cofi.org">www.cofi.org</a></p>

 <p><b>5</b> <b>No. 2</b> <b>KD-HT</b> <b>S-P-F</b> <b>NLGA</b></p> <p><small>©2000NLGA</small></p>	<p>Macdonald Inspection Services Ltd. <a href="http://www.gradestamp.com">www.gradestamp.com</a></p>										
<table border="1" style="border-collapse: collapse;"> <tr> <td style="padding: 5px;"><b>M</b></td> <td style="padding: 5px;"><b>S-P-F</b></td> </tr> <tr> <td style="padding: 5px;"><b>L</b><sup>®</sup></td> <td style="padding: 5px;"><b>No.1</b></td> </tr> <tr> <td style="padding: 5px;"><b>B</b></td> <td style="padding: 5px;"><b>KD-HT</b></td> </tr> <tr> <td colspan="2" style="padding: 5px;"><b>99 NLGA</b></td> </tr> </table> <p><small>©2000NLGA</small></p>	<b>M</b>	<b>S-P-F</b>	<b>L</b> <sup>®</sup>	<b>No.1</b>	<b>B</b>	<b>KD-HT</b>	<b>99 NLGA</b>		<p>Maritime Lumber Bureau <a href="http://www.mlb.ca">www.mlb.ca</a></p>		
<b>M</b>	<b>S-P-F</b>										
<b>L</b> <sup>®</sup>	<b>No.1</b>										
<b>B</b>	<b>KD-HT</b>										
<b>99 NLGA</b>											
<table border="1" style="border-collapse: collapse;"> <tr> <td style="padding: 5px;"><b>N</b></td> <td style="padding: 5px;"><b>NLGA</b></td> </tr> <tr> <td style="padding: 5px;"><b>L</b></td> <td style="padding: 5px;"><b>S-P-F</b></td> </tr> <tr> <td style="padding: 5px;"><b>P</b></td> <td style="padding: 5px;"><b>NO.1</b></td> </tr> <tr> <td style="padding: 5px;"><b>A</b><sup>®</sup></td> <td style="padding: 5px;"><b>000</b></td> </tr> <tr> <td colspan="2" style="padding: 5px;"><b>KD HT</b></td> </tr> </table> <p><small>©2000NLGA</small></p>	<b>N</b>	<b>NLGA</b>	<b>L</b>	<b>S-P-F</b>	<b>P</b>	<b>NO.1</b>	<b>A</b> <sup>®</sup>	<b>000</b>	<b>KD HT</b>		<p>Newfoundland &amp; Labrador Lumber Producers' Association c/o Canadian Lumber Standards Accreditation Board <a href="http://www.clsab.ca">www.clsab.ca</a></p>
<b>N</b>	<b>NLGA</b>										
<b>L</b>	<b>S-P-F</b>										
<b>P</b>	<b>NO.1</b>										
<b>A</b> <sup>®</sup>	<b>000</b>										
<b>KD HT</b>											
 <p><b>10</b> <b>CONST S-P-F</b> <b>S-GRN</b> <b>NLGA</b></p> <p><small>©2000NLGA</small></p>	<p>Northwest Territories Forest Industries Association</p>										
<p><b>CL</b><sup>®</sup><b>A 100</b> <b>1</b> <b>NLGA S-P-F</b> <b>KD-HT</b></p> <p><small>©2000NLGA</small></p>	<p>Ontario Forest Industries Association (Home of CLA Grading and Inspection) <a href="http://www.ofia.com">www.ofia.com</a></p>										
<p><b>O.L.M.A.</b><sup>®</sup> <b>09</b> <b>1</b> <b>KD-HT</b> <b>NLGA S-P-F</b></p> <p><small>©2000NLGA</small></p>	<p>Ontario Lumber Manufacturers' Association <a href="http://www.olma.ca">www.olma.ca</a></p>										
 <p><b>NO. 1</b> <b>KD - HT</b> <b>S-P-F</b> <b>00 NLGA RULES</b></p> <p><small>©2000NLGA</small></p>	<p>Pacific Lumber Inspection Bureau <a href="http://www.plib.org">www.plib.org</a></p>										



**A-Table 9.3.2.1. Lumber Grading.** To identify board grades, the paragraph number of the NLGA “Standard Grading Rules for Canadian Lumber” under which the lumber is graded must be shown in the grade mark. Paragraph 113 is equivalent to the WWPA “Western Lumber Grading Rules 2017” and paragraph 114 is equivalent to the WCLIB “Grading Rules for West Coast Lumber.” When graded in accordance with WWPA or WCLIB rules, the grade mark will not contain a paragraph number.

**A-9.3.2.8.(1) Non-Standard Lumber.** NLGA 2017, “Standard Grading Rules for Canadian Lumber,” permits lumber to be dressed to sizes below the standard sizes (38 × 89, 38 × 140, 38 × 184, etc.) provided the grade stamp shows the reduced size. This Sentence permits the use of the span tables for such lumber, provided the size indicated on the stamp is not less than 95% of the corresponding standard size. Allowable spans in the tables must be reduced a full 5% even if the undersize is less than the 5% permitted.

**A-9.3.2.9.(1) Protection from Termites.**

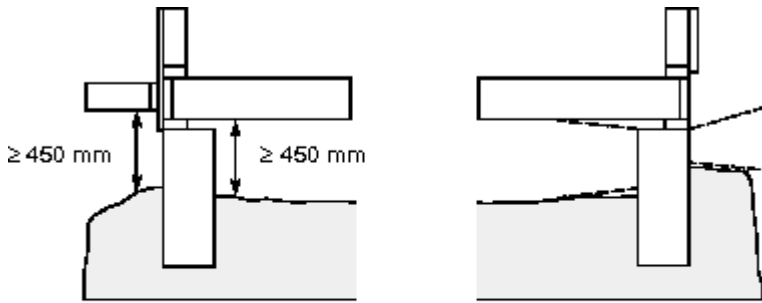




**Figure A-9.3.2.9.(1)-A**  
**Known termite locations**

**Note to Figure A-9.3.2.9.(1)-A:**

(1) Reference: J.K. Mauldin (1982), N.Y. Su (1995), T. Myles (1997).



clear height of 450 mm between structural wood elements and finished ground directly below

supporting elements visible to permit inspection<sup>(1)</sup>

EG020508

**Figure A-9.3.2.9(1)-B**

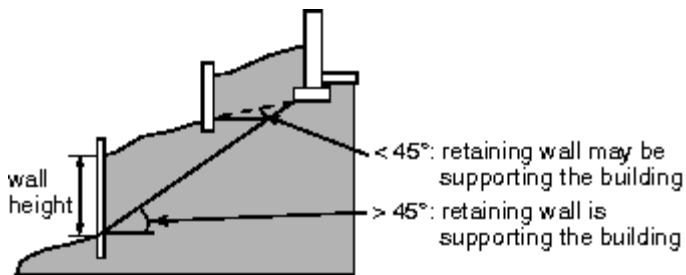
**Clearances under structural wood elements and visibility of supporting elements where required to permit inspection for termite infestation**

**Note to Figure A-9.3.2.9(1)-B:**

(1) For the height of structural wood elements not directly above finished ground, see Article 9.23.2.3.

**A-9.3.2.9.(3) Protection of Structural Wood Elements from Moisture and Decay.** There are many above-ground, structural wood systems where precipitation is readily trapped or drying is slow, creating conditions conducive to decay. Beams extending beyond roof decks, junctions between deck members, and connections between balcony guards and walls are three examples of elements that can accumulate water when exposed to precipitation if they are not detailed to allow drainage.

**A-9.3.2.9.(4) Protection of Retaining Walls and Cribbing from Decay.** Retaining walls supporting soil are considered to be structural elements of the building if a line drawn from the outer edge of the footing to the bottom of the exposed face of the retaining wall is greater than 45° to the horizontal. Retaining walls supporting soil may be structural elements of the building if the line described above has a lower slope.



EG020514

**Figure A-9.3.2.9(4)**

**Identifying retaining walls that require preservative treatment**

Retaining walls that are not critical to the support of building foundations but are greater than 1.2 m in height may pose a danger of sudden collapse to persons adjacent to the wall if the wood is not adequately protected from decay. The height of the retaining wall or cribbing is measured as the vertical difference between the ground levels on each side of the wall.

**A-9.4.1.1. Structural Design.** Article 9.4.1.1. establishes the principle that the structural members of Part 9 buildings must

- comply with the prescriptive requirements provided in Part 9,

- be designed in accordance with accepted good practice, or
- be designed in accordance with Part 4 using the loads and limits on deflection and vibration specified in Part 9 or Part 4.

Usually a combination of approaches is used. For example, even if the snow load calculation on a wood roof truss is based on Subsection 9.4.2., the joints must be designed in accordance with Part 4. Wall framing may comply with the prescriptive requirements in Subsections 9.23.3., 9.23.10., 9.23.11. and 9.23.12., while the floor framing may be engineered.

Design according to Part 4 or accepted good engineering practice, such as that described in the CWC, "Engineering Guide for Wood Frame Construction", requires engineering expertise. The CWC Guide contains alternative solutions and provides information on the applicability of the Part 9 prescriptive structural requirements to further assist designers and building officials to identify the appropriate design approach. The need for professional involvement in the structural design of a building, whether to Part 4 or Part 9 requirements or accepted good practice, is defined by provincial and territorial legislation.

**A-9.4.2.1. and 9.4.2.2. Application of Simplified Part 9 Snow Loads.** The simplified specified snow loads described in Article 9.4.2.2. may be used where the structure is of the configuration that is typical of traditional wood-frame residential construction and its performance. This places limits on the spacing of joists, rafters and trusses, the spans of these members and supporting members, deflection under load, overall dimensions of the roof and the configuration of the roof. It assumes considerable redundancy in the structure.

Because very large buildings may be constructed under Part 9 by constructing firewalls to break up the building area, it is possible to have Part 9 buildings with very large roofs. The simplified specified snow loads may not be used when the total roof area of the overall structure exceeds 4 550 m<sup>2</sup>. Thus, these snow loads may be used for typical townhouse construction, but would not be appropriate for much larger commercial or industrial buildings, for example.

The simplified specified snow load calculation of Sentence 9.4.2.2.(1) is not applicable to roof configurations that seriously exacerbate snow accumulation. This limitation does not pertain to typical projections above a sloped roof, such as dormers, but rather to high parapets and other significant projections above a flat roof, such as elevator penthouses, mechanical rooms and larger equipment, that collect snow and prevent it from blowing off the roof.

Although multi-level roofs generally lead to snow drift loads, smaller light-frame buildings constructed according to Part 9 have not collapsed under these loads. Consequently, the simplified calculation may be used for multi-level roofs where the upper level roof does not exceed 600 m<sup>2</sup> in area. For multi-level roofs with larger upper roof areas (formed by multiple adjoining Part 9 buildings), where the upper level roof has a slope less than 1 in 6 and the roof step has a height greater than 2 m, the snow drift load on the lower level roof near the roof step must be considered in accordance with Sentence 9.4.2.2.(4).

The reference in Clause 9.4.2.1.(1)(d) to Article 9.4.3.1. invokes, for roof assemblies other than common lumber trusses, the same performance criteria for deflection.

Values of the specific weight of snow on roofs,  $\gamma$ , obtained from measurements at a number of weather stations across Canada ranged from about 1.0 to 4.5 kN/m<sup>3</sup> with an average of approximately 3.0 kN/m<sup>3</sup>. ASCE/SEI 7, "Minimum Design Loads for Buildings and Other Structures," contains a formula to calculate the increase in the value of  $\gamma$  based on an increase in the ground snow load:  $0.43S_s + 2.2$  kN/m<sup>3</sup>. This formula provides results that are reasonably consistent with Canada's climatic reality. In Clause 9.4.2.1.(1)(f), the specific weight of snow is capped at 4.0 kN/m<sup>3</sup>, as higher values are extremely rare.

**A-9.4.2.3.(1) Accessible Platforms Subject to Snow and Occupancy Loads.** Many platforms are subject to both occupancy loads and snow loads. These include balconies, decks, verandas, flat roofs over garages and carports. Where such a platform, or a segregated area of such a platform, serves a single dwelling unit, it must be designed for the greater of either the specified snow load or an occupancy load of 1.9 kPa. Where the platform serves more than one single dwelling unit or an occupancy other than a residential occupancy, higher occupancy loads will apply as specified in Table 4.1.5.3.

**A-9.4.2.4.(1) Specified Loads for Attics or Roof Spaces with Limited Accessibility.** Typical residential roofs are framed with roof trusses and the ceiling is insulated.

Residential trusses are placed at 600 mm on centre with web members joining top and bottom chords. Lateral web bracing is installed perpendicular to the span of the trusses. As a result, there is limited room for movement inside the attic or roof space or for storage of material. Access hatches are generally built to the minimum acceptable dimensions, further limiting the size of material that can be moved into the attic or roof space.

With exposed insulation in the attic or roof space, access is not recommended unless protective clothing and breathing apparatus are worn.

Thus the attic or roof space is recognized as uninhabitable and loading can be based on actual dead load. In emergency situations or for the purpose of inspection, it is possible for a person to access the attic or roof space without over-stressing the truss or causing damaging deflections.

Note A-9.4.2.5. Seismic Design Parameter. The seismic design parameter,  $S_{max}$ , is used as a trigger for the application of seismic design provisions in Part 9. It was derived by considering the upper limit on the minimum lateral earthquake force,  $V$ , as specified in Clause 4.1.8.11.(2)(c), and is taken as the larger of  $2/3 S(0.2)$  and  $S(0.5)$ , with  $S(0.2)$  and  $S(0.5)$  calculated in accordance with Sentence 4.1.8.4.(6).

Note A-9.4.2.5.(2) Determination of Site Class. To benefit from a refined, and possibly less conservative, value of  $S_{max}$ , the Site Class can be determined on the basis of the ground profile at the site in accordance with Article 4.1.8.4. Determination of the Site Class will require the involvement of a suitably qualified and experienced professional engineer.

A-Table 9.4.4.1. Classification of Soils. Sand or gravel may be classified by means of a picket test in which a 38 mm by 38 mm picket beveled at the end at 45° to a point is pushed into the soil. Such material is classified as “dense or compact” if a man of average weight cannot push the picket more than 200 mm into the soil and “loose” if the picket penetrates 200 mm or more.

Clay and silt may be classified as “stiff” if it is difficult to indent by thumb pressure, “firm” if it can be indented by moderate thumb pressure, “soft” if it can be easily penetrated by thumb pressure, where this test is carried out on undisturbed soil in the wall of a test pit.

A-9.4.4.4.(1) Soil Movement. In susceptible soils, changes in temperature or moisture content can cause significant expansion and contraction. Soils containing pyrites can expand simply on exposure to air.

#### **Expansion and Contraction due to Moisture**

Clay soils are most prone to expansion and contraction due to moisture. Particularly wet seasons can sufficiently increase the volume of the soil under and around the structure to cause heaving of foundations and floors-on-ground, or cracking of foundation walls. Particularly dry seasons or draw-down of water by fast-growing trees can decrease the volume of the soil supporting foundations and floors-on-ground, thus causing settling.

#### **Frost Heave**

Frost heave is probably the most commonly recognized phenomenon related to freezing soil. Frost heave results when moisture in frost-susceptible soil (clay and silt) under the footings freezes and expands. This mechanism is addressed by requirements in Section 9.12. regarding the depth of excavations.

### **Ice Lenses**

When moisture in frost-susceptible soils freezes, it forms an ice lens and reduces the vapour pressure in the soil in the area immediately around the lens. Moisture in the ground redistributes to rebalance the vapour pressures providing more moisture in the area of the ice lens. This moisture freezes to the lens and the cycle repeats itself. As the ice lens grows, it exerts pressure in the direction of heat flow. When lenses form close to foundations and heat flow is toward the foundation—as may be the case with unheated crawl spaces or open concrete block foundations insulated on the interior—the forces may be sufficient to crack the foundation.

### **Adfreezing**

Ice lenses can adhere themselves to cold foundations. Where heat flow is essentially upward, parallel to the foundation, the pressures exerted will tend to lift the foundation. This may cause differential movement or cracking of the foundation. Heat loss through basement foundations of cast-in-place concrete or concrete block insulated on the exterior appears to be sufficient to prevent adfreezing. Care must be taken where the foundation does not enclose heated space or where open block foundations are insulated on the interior. The installation of semi-rigid glass fibre insulation has demonstrated some effectiveness as a separation layer to absorb the adfreezing forces.

### **Pyrites**

Pyrite is the most common iron disulphide mineral in rock and has been identified in rock of all types and ages. It is most commonly found in metamorphic and sedimentary rock, and especially in coal and shale deposits.

Weathering of pyritic shale is a chemical-microbiological oxidation process that results in volume increases that can heave foundations and floors-on-ground. Concentrations of as little as 0.1% by weight have caused heaving. Weathering can be initiated simply by exposing the pyritic material to air. Thus, building on soils that contain pyrites in concentrations that will cause damage to the building should be avoided, or measures should be taken to remove the material or seal it. Material containing pyrites should not be used for backfill at foundations or for supporting foundations or floors-on-ground.

Where it is not known if the soil or backfill contains pyritic material in a deleterious concentration, a test is available to identify its presence and concentration.

### **References:**

- (1) Legget, R.F. and Crawford, C.B. Trees and Buildings. Canadian Building Digest 62, Division of Building Research, National Research Council Canada, Ottawa, 1965.
- (2) Hamilton, J.J. Swelling and Shrinking Subsoils. Canadian Building Digest 84, Division of Building Research, National Research Council Canada, Ottawa, 1966.
- (3) Hamilton, J.J. Foundations on Swelling and Shrinking Subsoils. Canadian Building Digest 184, Division of Building Research, National Research Council Canada, Ottawa, 1977.
- (4) Penner, W., Eden, W.J., and Gratten-Bellew, P.E. Expansion of Pyritic Shales. Canadian Building Digest 152, Division of Building Research, National Research Council Canada, Ottawa, 1975.

(5) Swinton, M.C., Brown, W.C., and Chown, G.A. Controlling the Transfer of Heat, Air and Moisture through the Building Envelope. Small Buildings - Technology in Transition, Building Science Insight '90, Institute for Research in Construction, National Research Council Canada, Ottawa, 1990.

**A-9.4.4.6. and 9.15.1.1. Loads on Foundations.** The prescriptive solutions provided in Part 9 relating to footings and foundation walls only account for the loads imposed by drained earth. Drained earth is assumed to exert a load equivalent to the load that would be exerted by a fluid with a density of 480 kg/m<sup>3</sup>. The prescriptive solutions do not account for surcharges from saturated soil or additional loads from heavy objects located adjacent to the building. Where such surcharges are expected, the footings and foundation walls must be designed and constructed according to Part 4.

**A-9.5.1.2. Combination Rooms.** If a room draws natural light and natural ventilation from another area, the opening between the two areas must be large enough to effectively provide sufficient light and air. This is why a minimum opening of 3 m<sup>2</sup> is required, or the equivalent of a set of double doors. The effectiveness of the transfer of light and air also depends on the size of the transfer opening in relation to the size of the dependent room; in measuring the area of the wall separating the two areas, the whole wall on the side of the dependent room should be considered, not taking into account offsets that may be in the surface of the wall.

The opening does not necessarily have to be in the form of a doorway; it may be an opening at eye level. However, if the dependent area is a bedroom, provision must be made for the escape window required by Article 9.9.10.1. to fulfill its safety function. This is why a direct passage is required between the bedroom and the other area; the equivalent of at least a doorway is therefore required for direct passage between the two areas.

**A-9.5.3.1. Ceiling Heights and Clear Heights.** Figure A-9.5.3.1. shows ceiling heights in relation to clear heights and also clear heights over stairs described in Article 9.8.2.2.

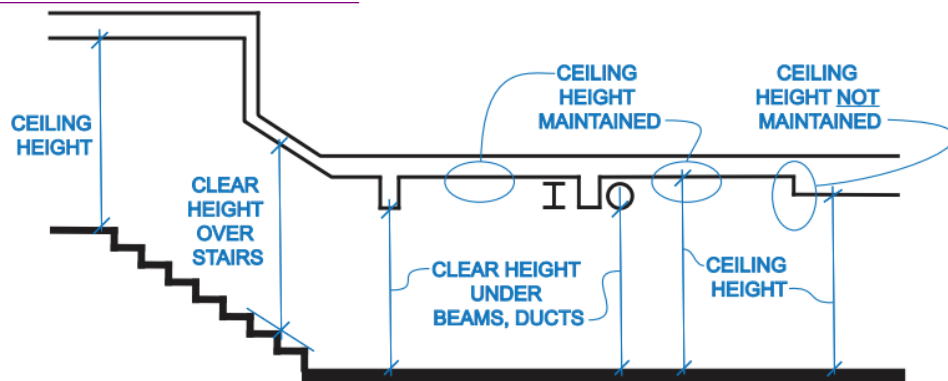


Figure A-9.5.3.1.  
Ceiling Heights and Clear Heights

**A-9.5.5.3. Doorways to Rooms with a Bathtub, Shower or Water Closet.** The intent of Article 9.5.5.3. is to ensure a certain degree of access to rooms that provide some or all of the facilities found in a typical residential bathroom.

If the minimum 860 mm hallway serves more than one room with identical facilities, only one of the rooms is required to have a door not less than 760 mm wide.

If a number of rooms have different facilities, for example, one room has a shower, lavatory and water closet, and another room has a lavatory and water closet, the room with the shower, lavatory and water closet must have the minimum 760 mm wide door. Where multiple rooms

provide the same or similar facilities, one of these rooms must comply with the requirement to have at least one bathtub or shower, one lavatory and one water closet. Where the fixtures are located in two separate rooms served by the same hallway, the requirement for the minimum doorway width would apply to both rooms.

If the minimum 860 mm hallway does not serve any room containing a bathtub, shower and water closet, additional fixtures do not need to be installed.

**A-9.6.1.1.(1) Application.** The scope of this Section includes glass installed on the interior or on the exterior of a building.

**A-9.6.1.2.(2) Mirrored Glass Doors.** CAN/CGSB-82.6-M, "Doors, Mirrored Glass, Sliding or Folding, Wardrobe," covers mirrored glass doors for use on reach-in closets. It specifies that such doors are not to be used for walk-in closets.

**A-Table 9.6.1.3 Glass in Doors.** Maximum areas in Table 9.6.1.3. for other than fully tempered glazing are cut off at 1.50 m<sup>2</sup>, as this would be the practical limit after which safety glazing would be required by Sentence 9.6.1.4.(2).

**A-9.7. Windows, Doors and Skylights.** This section applies only to windows, doors and skylights as defined in the scope of the standards referenced in Article 9.7.4.2. Other glazed products, such as site-built windows, curtain walls or sloped glazing, are required to conform to Part 5.

It is also permitted for fenestration products within the scope of the NAFS standard to conform to Part 5. This option is typically used for windows and doors that are impractical to subject to the testing requirements of NAFS due to their size or for custom configurations

**A-9.7.3.2.(1)(a) Minimizing Condensation.** The total prevention of condensation on the surfaces of fenestration products is difficult to achieve and, depending on the design and construction of the window or door, may not be absolutely necessary. Clause 9.7.3.2.(1)(a) therefore requires that condensation be minimized, which means that the amount of moisture that condenses on the inside surface of a window, door or skylight, and the frequency at which this occurs, must be limited. The occurrence of such condensation must be sufficiently rare, the accumulation of any water must be sufficiently small, and drying must be sufficiently rapid to prevent the deterioration of moisture-susceptible materials and the growth of fungi.

**A-9.7.4. Design and Construction.** Garage doors, sloped glazing, curtain walls, storefronts, commercial entrance systems, site-built or site-glazed products, revolving doors, interior windows and doors, storm windows, storm doors, sunrooms and commercial steel doors are not in the scope of NAFS.

All windows, doors and skylights installed to separate conditioned space from unconditioned space or the exterior must also conform to ~~Section 9.36.~~ Part 10.

**A-9.7.4.2.(1) Standards Referenced for Windows, Doors and Skylights.**

#### **General**

Doors between an unconditioned garage and a dwelling unit are considered to be in scope of the standard referenced in this Sentence. Although the standard refers to windows in "exterior building envelopes", a note to the definition of "building envelope" clarifies that for the purpose of application of the standard, in some cases a building envelope may consist of 2 separate walls (such as a wall between garage and dwelling unit as well as the exterior wall of the garage itself).

A door leading to the exterior from an unconditioned garage is also within scope of the referenced standard, as it is also part of the exterior building envelope. However, because the scope of the BC Building Code takes precedence, these doors are not required to conform to

“NAFS”. This Subsection of the Code does not apply to a door separating two unconditioned spaces.

### **Canadian Requirements in the Harmonized Standard**

In addition to referencing the Canadian Supplement, CSA A440S1, “Canadian Supplement to AAMA/WDMA/CSA 101/I.S.2/A440-17, North American Fenestration Standard/Specification for windows, doors, and skylights,” the Harmonized Standard, AAMA/WDMA/CSA 101/I.S.2/A440, “North American Fenestration Standard/Specification for windows, doors, and skylights,” contains some Canada-specific test criteria.

### **Standards Referenced for Excluded Products**

Clause 1.1, General, of the Harmonized Standard defines the limits to the application of the standard with respect to various types of fenestration products. A list of exceptions to the application statement identifies a number of standards that apply to excluded products. Compliance with those standards is not required by the Code; the references are provided for information purposes only.

### **Label Indicating Performance and Compliance with Standard**

The Canadian Supplement requires that a product's performance ratings be indicated on a label according to the designation requirements in the Harmonized Standard and that the label include

- design pressure, where applicable,
- negative design pressure, where applicable,
- water penetration test pressure, and
- the Canadian air infiltration and exfiltration levels.

It should be noted that, for a product to carry a label in Canada, it must meet all of the applicable requirements of both the Harmonized Standard and the Canadian Supplement, including the forced entry requirements.

### **Water Penetration Resistance**

For the various performance grades listed in the Harmonized Standard, the corresponding water penetration resistance test pressures are a percentage of the design pressure. For R-class products, water penetration resistance test pressures are 15% of design pressure. In Canada, driving rain wind pressures (DRWP) have been determined for the locations listed in Appendix C. These are listed in the Canadian Supplement. The DRWP given in the Canadian Supplement must be used for all products covered in the scope of the Harmonized Standard when used in buildings within the scope of Part 9.

To achieve equivalent levels of water penetration resistance for all locations, the Canadian Supplement includes a provision for calculating specified DRWP at the building site considering building exposure. Specified DRWP values are, in some cases, greater than 15% of design pressure and, in other cases, less than 15% of design pressure. For a fenestration product to comply with the Code, it must be able to resist the structural and water penetration loads at the building site. Reliance on a percentage of design pressure for water penetration resistance in the selection of an acceptable fenestration product will not always be adequate. Design pressure values are reported on a secondary designator, which is required by the Canadian Supplement to be affixed to the window. The DRWP given in the Canadian Supplement should be used for all products covered in the scope of the Harmonized Standard.

As an alternative to the above noted provision in the Canadian Supplement for calculating specified DRWP, the Water Resistance values listed in Table C-4 of Appendix C may be used.



## **Uniform Load Structural Test**

The Harmonized Standard specifies that fenestration products be tested at 150% of design pressure for wind (specified wind load) and that skylights and roof windows be tested at 200% of design pressure for snow (specified snow load). With the change in the NBC 2005 to a 1-in-50 return period for wind load, a factor of 1.4 rather than 1.5 is now applied for wind. The NBC has traditionally applied a factor of 1.5 rather than 2.0 for snow. Incorporating these lower load factors into the Code requirements for fenestration would better reflect acceptable minimum performance levels; however, this has not been done in order to avoid adding complexity to the Code, to recognize the benefits of Canada-US harmonization, and to recognize that differentiation of products that meet the Canadian versus the US requirements would add complexity for manufacturers, designers, specifiers and regulatory officials.

The required design pressure and Performance Grade (PG) rating of doors and windows has been listed for each of the geographic locations found in the Code in Table C-4. These may be used as an alternative to the specified wind load calculations in the Canadian Supplement.

## **Condensation Resistance**

The Harmonized Standard identifies three test procedures that can be used to determine the condensation resistance of windows and doors. Only the physical test procedure given in CSA A440.2, "Fenestration energy performance," which is referenced in Table 9.7.3.3., can be used to establish Temperature Index (I) values. Computer simulation tools can also be used to estimate the relative condensation resistance of windows, but these methods employ different expressions of performance known as Condensation Resistance Factors (CR). I and CR values are not interchangeable.

Where removable multiple glazing panels (RMGP) are installed on the inside of a window, care should be taken to hermetically seal the RMGP against the leakage of moisture-laden air from the interior into the cavity on the exterior of the RMGP because the moisture transported by the air could lead to significant condensation on the interior surface of the outside glazing.

## **Basement Windows**

Clause 12.4.2, Basement Windows, of the Harmonized Standard refers to products that are intended to meet Code requirements for ventilation and emergency egress. The minimum test size of 800 mm × 360 mm (total area of 0.288 m<sup>2</sup>) specified in the standard will not provide the minimum openable area required by the Code for bedrooms (i.e. 0.35 m<sup>2</sup> with no dimension less than 380 mm) and the means to provide minimum open area identified in the standard is inconsistent with the requirements of the Code (see Subsection 9.9.10. for bedroom windows). The minimum test size specified in the standard will also not provide the minimum ventilation area of 0.28 m<sup>2</sup> required for non-heating-season natural ventilation (see Article 9.32.2.2.).

## **Performance of Doors: Limited Water Ingress Control**

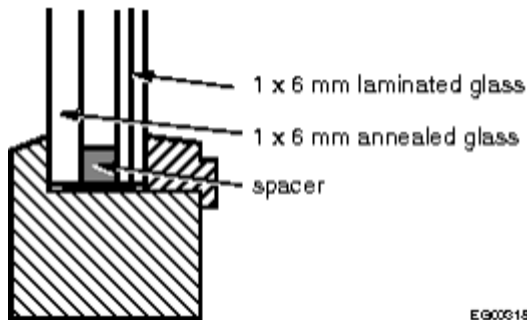
While the control of precipitation ingress is a performance requirement for exterior doors, side-hinged doors can comply with the referenced standard, AAMA/WDMA/CSA 101/I.S.2/A440, "North American Fenestration Standard/Specification for windows, doors, and skylights," when tested at a pressure differential of 0 Pa (0.0 psf) or higher, but less than the minimum test pressure required for the indicated performance class and performance grade. Such doors are identified with a "Limited Water" (LW) rating on the product label.

Conditions suitable for the installation of an LW rated door are identified in Sentence 9.7.4.2.(2).

A-9.7.4.3.(2) Performance Requirements. If the option of calculating design pressure performance grade and water resistance values using the Canadian Supplement is chosen, the DRWP values in Table A.1 of that standard must be used for all buildings within the scope of Part 9 of the BC

Building Code. This requirement applies whether the windows, doors and skylights are designed to conform to Article 9.7.4.2. or to Part 5.

**A-9.7.5.2.(1) Forced Entry Via Glazing in Doors and Sidelights.** There is no mandatory requirement that special glass be used in doors or sidelights, primarily because of cost. It is, however, a common method of forced entry to break glass in doors and sidelights to gain access to door hardware and unlock the door from the inside. Although insulated glass provides increased resistance over single glazing, the highest resistance is provided by laminated glass. Tempered glass, while stronger against static loads, is prone to shattering under high, concentrated impact loads.



**Figure A-9.7.5.2.(1)**  
**Combined laminated/annealed glazing**

Laminated glass is more expensive than annealed glass and must be used in greater thicknesses. Figure A-9.7.5.2.(1) shows an insulated sidelight made of one pane of laminated glass and one pane of annealed glass. This method reduces the cost premium that would result if both panes were laminated.

Consideration should be given to using laminated glazing in doors and accompanying sidelights regulated by Article 9.6.1.3., in windows located within 900 mm of locks in such doors, and in basement windows.

ULC Standards has produced ULC-S332, "Standard for Burglary Resisting Glazing Material," which provides a test procedure to evaluate the resistance of glazing to attacks by thieves. While it is principally intended for plate glass show windows, it may be of value for residential purposes.

**A-9.7.5.2.(2) Resistance of Doors To Forced Entry.** Sentence 9.7.5.2.(2) designates standard ASTM F476, "Standard Test Methods for Security of Swinging Door Assemblies," as an alternative to compliance with the prescriptive requirements for doors and hardware. The annex to the standard provides four security classifications, with acceptance criteria, depending on the type of building and the crime rate of the area in which it is located. The NBC only specifies Grade 10, the minimum level. The annex suggests the following guidelines be followed when selecting security levels for door assemblies:

Grade 10: This is the minimum security level and is quite adequate for single-family residential buildings located in stable, low-crime areas.

Grade 20: This is the low-medium security level and is designed to provide security for residential buildings located in average crime-rate areas and for apartments in both low and average crime-rate areas.

Grade 30: This is the medium-high security level and is designed to provide security for residential buildings located in higher than average crime-rate areas or for small commercial buildings in average or low crime-rate areas.

Grade 40: This is the high security level and is designed for small commercial buildings located in high crime-rate areas. This level could also be used for residential buildings having an exceptionally high incidence of semi-skilled burglary attacks.

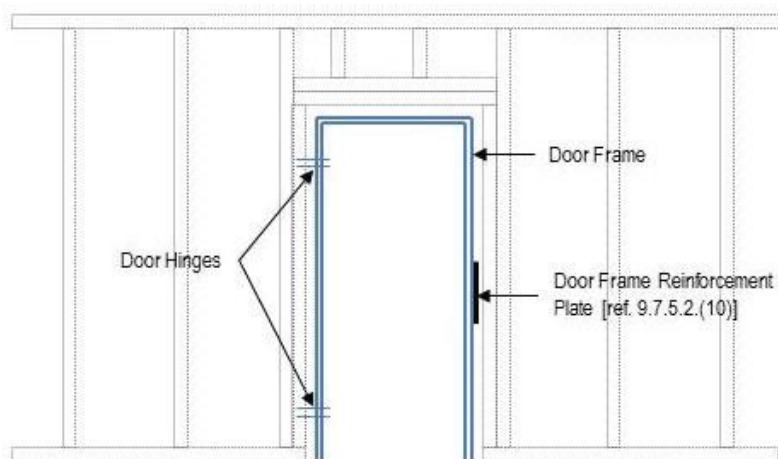
All these grades satisfy the Code and can be considered for use where a higher level of security is desired or warranted.

**A-9.7.5.2.(6) Door Fasteners.** The purpose of the requirement for 30 mm screw penetration into solid wood is to prevent the door from being dislodged from the jamb due to impact forces. It is not the intent to prohibit other types of hinges or strikeplates that are specially designed to provide equal or greater protection.

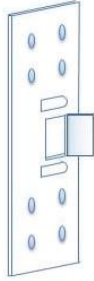
**A-9.7.5.2.(8) Hinged Doors.** Methods of satisfying this Sentence include either using non-removable pin hinges or modifying standard hinges by screw fastening a metal pin in a screw hole in one half of the top and bottom hinges. When the door is closed, the projecting portion of the pin engages in the corresponding screw hole in the other half of the hinge and then, even if the hinge pin is taken out, the door cannot be removed.

**A-9.7.5.2.(10) & (11) Resistance to Forced Entry.** Statistical evidence by Vancouver Police has identified that a frequently exploited point of entry in break-ins exists at the residential entry doors due to inherent weaknesses in wood door frame materials, and the location of strikeplate screws located along the grain and near to the deadbolt throw, which contribute to inability for the frame to resist forced entry.

The installation of a metal frame reinforcement plate (See Figures A-9.7.5.2.(10)-A & -B below) directly attached to the backside of a door frame before installation with increased spacing for the points of attachment would significantly increase the resistance of the door to forced entry. This will result reduced incidence of crime and significantly reduce potential costs to owners.



**Figure A-9.7.5.2.(10)-A**  
**Typical Location of Door Frame Reinforcement**



**Figure A-9.7.5.2.(10)-B**  
**Frame Reinforcement (Example)**

**A-9.7.5.3.(1) Resistance of Windows to Forced Entry.** Although this Sentence only applies to windows within 2 m of adjacent ground level, certain house and site features, such as balconies or canopy roofs, allow for easy access to windows at higher elevations. Consideration should be given to specifying break-in resistant windows in such locations.

This Sentence does not apply to windows that do not serve the interior of the dwelling unit, such as windows to garages, sun rooms or greenhouses, provided connections between these spaces and the dwelling unit are secure.

One method that is often used to improve the resistance of windows to forced entry is the installation of metal “security bars.” However, while many such installations are effective in increasing resistance to forced entry, they may also reduce or eliminate the usefulness of the window as an exit in case of fire or other emergency that prevents use of the normal building exits. Indeed, unless such devices are easily openable from the inside, their installation in some cases would contravene the requirements of Article 9.9.10.1., which requires every bedroom that does not have an exterior door to have at least one window that is large enough and easy enough to open that it can be used as an exit in case of emergency. Thus an acceptable security bar system should be easy to open from the inside while still providing increased resistance to entry from the outside.

A-9.8.4. Tread Configurations. The Code distinguishes four principal types of stair treads :

- rectangular treads, which are found in straight flights;
- tapered treads, which are found in curved flights (the term tapered tread also includes winders); and
- winders are described in Note A-9.8.4.6.

See Figure A-9.8.4.-A.

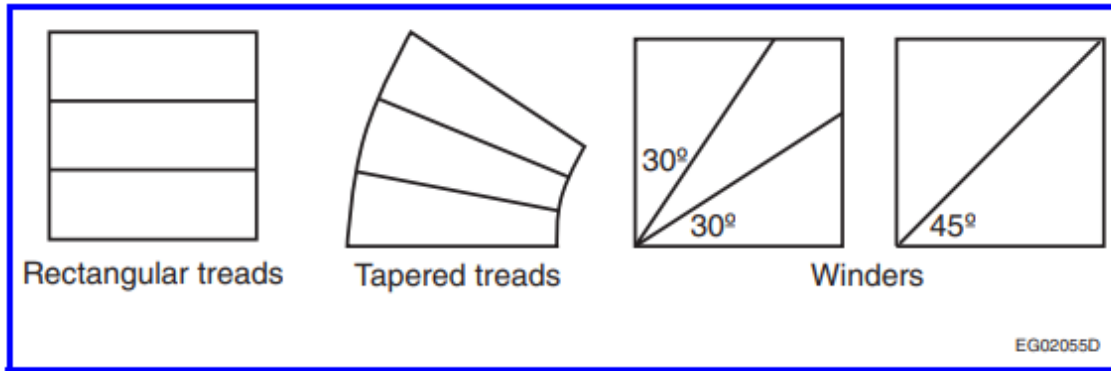
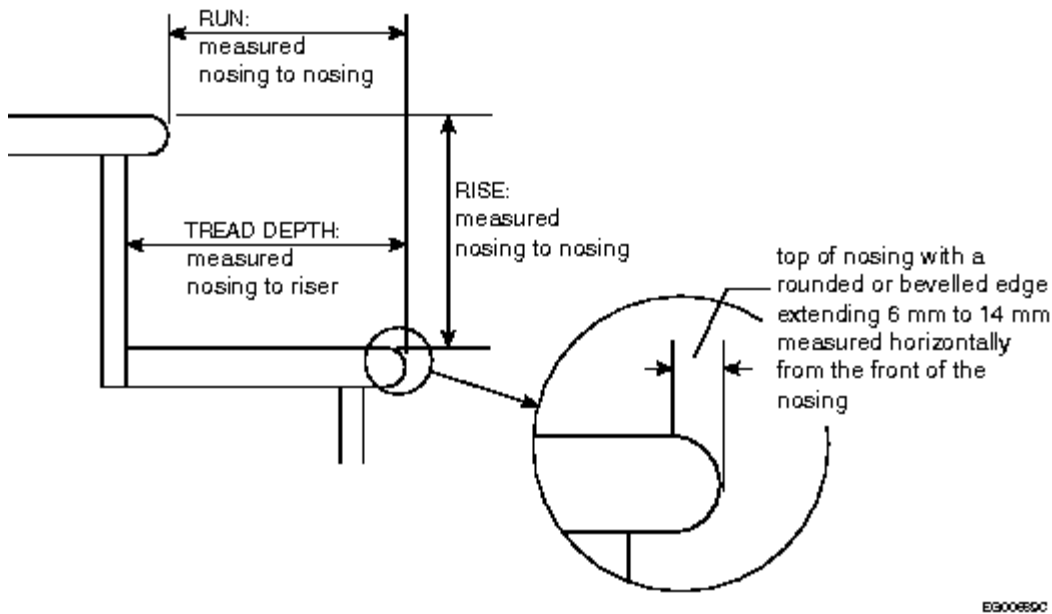


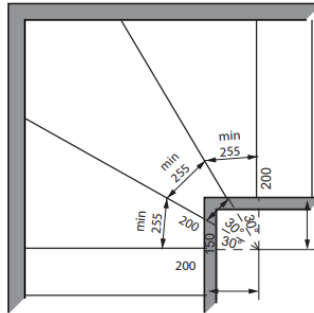
Figure A-9.8.4.-A  
Types of treads

Articles 9.8.4.1. to 9.8.4.8. specify various dimensional limits for steps. Figure A-9.8.4.-B illustrates the elements of a step and how these are to be measured.



**Figure A-9.8.4.-B**  
**Step dimensions and their measurement**

**A-9.8.4.6. Winders.** Where a stair must turn, the safest method of incorporating the turn is to use a landing. Within a dwelling unit, however, where occupants are familiar with their environment, winders are an acceptable method of reducing the amount of floor area devoted to the stair and have not been shown to be more hazardous than a straight run of steps. Nevertheless, care is required to ensure that winders are as safe as possible. Experience has shown that 30° winders are the best compromise and require the least change in the natural gait of the stair user; 45° winders are also acceptable, as they are wider. The Code permits only these two angles. Although it is normal Code practice to specify upper and lower limits, in this case it is necessary to limit the winders to specific angles with no tolerance above or below these angles other than normal construction tolerances. One result of this requirement is that winder-type turns in stairs are limited to 30° or 45° (1 winder), 60° (2 winders), or 90° (2 or 3 winders). See Figure A-9.8.4.6.



**Figure A-9.8.4.6.  
Winders**

**A-9.8.4.8. Tread Nosings.** A sloped or beveled edge on tread nosings will make the tread more visible through light modeling. The sloped portion of the nosing must not be too wide so as to reduce the risk of slipping of the foot. See Figure A-9.8.4.-B.

**A-9.8.6.2.(2) Exemption from Required Landing at Top of Stairs.** A door that swings away from a stair exposes sufficient floor space to act as a landing for users before descending the stairs.

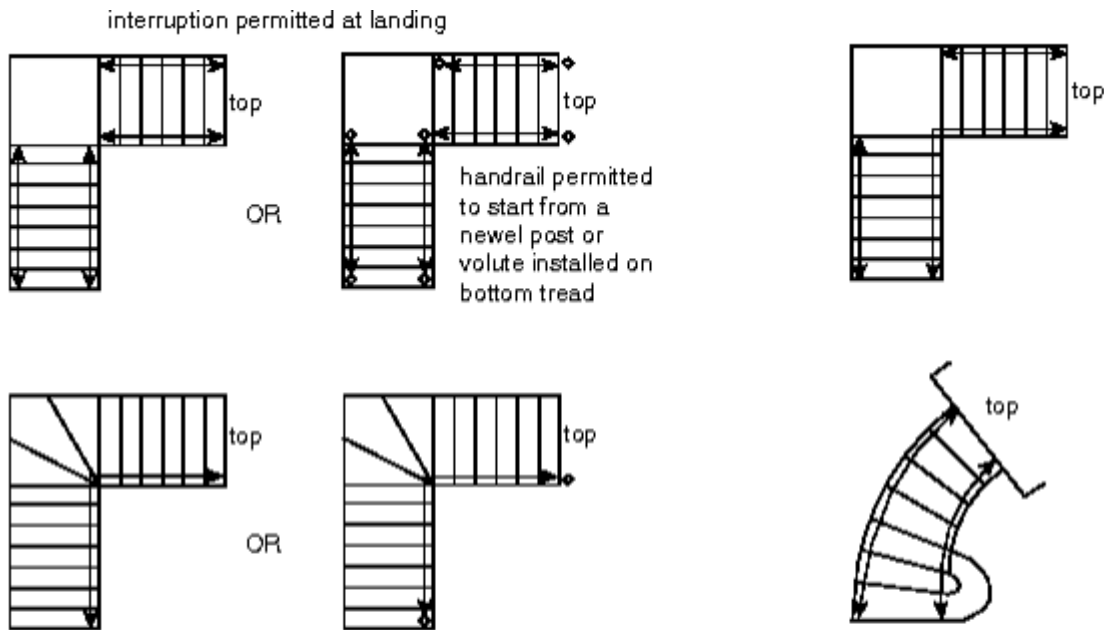
**A-9.8.7.1.(2) Wider Stairs than Required.** The intent of Sentence 9.8.7.1.(2) is that handrails be installed in relation to the required exit width only, regardless of the actual width of the stair and ramp. The required handrails are provided along the assumed natural path of travel to, from and within the building.

**A-9.8.7.2. Continuity of Handrails.** The guidance and support provided by handrails is particularly important at the beginning and end of ramps and flights of stairs and at changes in direction such as at landings and winders.

The intent of the requirement in Sentence (2) for handrails to be continuous throughout the length of the stair is that the handrail be continuous from the bottom riser to the top riser of the stair. (See Figure A-9.8.7.2.)

For stairs or ramps serving a single dwelling unit, the intent of the requirement for handrails to be continuous throughout the length of the flight is that the handrail be continuous from the bottom riser to the top riser of the flight. The required handrail may start back from the bottom riser only if it is supported by a newel post or volute installed on the bottom tread. (See Figure A-9.8.7.2.) With regard to stairs serving a single dwelling unit, the handrail may terminate at landings.

In the case of stairs within dwelling units that incorporate winders, the handrail should be configured so that it will in fact provide guidance and support to the stair user throughout the turn through the winder.



Stairs serving a single dwelling unit or a house with a secondary suite (including their common spaces):  
 required handrails continuous throughout length of flight from bottom riser to top riser

Stairs not serving a single dwelling unit or a house with a secondary suite (including their common spaces):  
 at least one required handrail continuous throughout length of stair, including at landings except where interrupted by doorways

↔ minimum extent of handrail where handrail is required<sup>(1)</sup>  
 ◆ newel post

EG000570

**Figure A-9.8.7.2.**  
**Continuity of handrails on stairs**

**Note to Figure A-9.8.7.2.:**

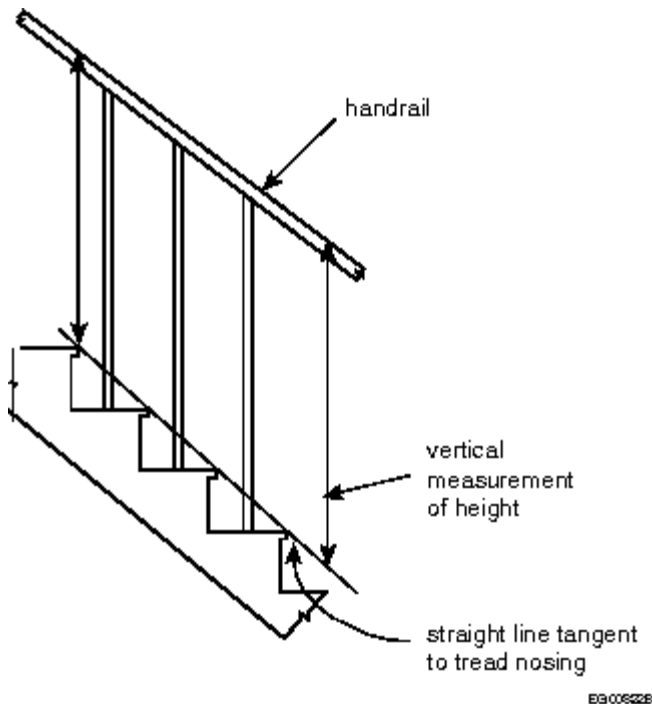
(1) See Article 9.8.7.1. to determine the number of handrails required. Some stairs will require only one, while some will require two or more.

**A-9.8.7.3.(1) Termination of Handrails.** Handrails are required to be installed so as not to obstruct pedestrian travel. To achieve this end, the rail should not extend so far into a hallway as to reduce the clear width of the hallway to less than the required width. Where the stair terminates in a room or other space, likely paths of travel through that room or space should be assessed to ensure that any projection of the handrail beyond the end of the stair will not interfere with pedestrian travel. As extensions of handrails beyond the first and last riser are not required in dwelling units (see Sentence 9.8.7.3.(2)) and as occupants of dwellings are generally familiar with their surroundings, the design of dwellings would not generally be affected by this requirement.

Handrails are also required to terminate in a manner that will not create a safety hazard to blind or visually impaired persons, children whose head may be at the same height as the end of the rail, or persons wearing loose clothing or carrying items that might catch on the end of the rail. One approach to reducing potential hazards is returning the handrail to a wall, floor or post. Again, within dwelling units, where occupants are generally familiar with their surroundings, returning the handrail to a wall, floor or post may not be necessary. For example, where the handrail is fastened to a wall and does not project past the wall into a hallway or other space, a reasonable degree of safety is assumed to be provided; other alternatives may provide an equivalent level of protection.

**A-9.8.7.3.(2) Handrail Extensions.** As noted in Note A-9.8.7.2., the guidance and support provided by handrails is particularly important at the beginning and end of ramps and flights of stairs and at changes in direction. The extended handrail provides guidance and allows users to steady themselves upon entering or leaving a ramp or flight of stairs. Such extensions are particularly useful to visually impaired persons, and persons with physical disabilities or who are encumbered in their use of the stairs or ramp.

A-9.8.7.4. Height of Handrails. Figure A-9.8.7.4. illustrates how to measure handrail height.



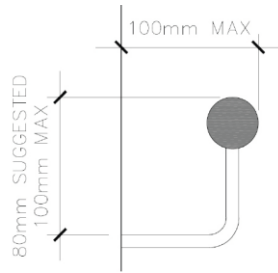
**Figure A-9.8.7.4.**  
**Measuring handrail height**

**A-9.8.7.5.(2) Handrail Sections.** Handrails are intended to provide guidance and support to stair users. To fulfil this intent, handrails must be “graspable.”

The graspable portion of a handrail should allow a person to comfortably and firmly grab hold by allowing their fingers and thumb to curl under part or all of the handrail. Where the configuration or dimensions of the handrail do not allow a person's fingers and thumb to reach the bottom of it, recesses that are sufficiently wide and deep to accommodate a person's fingers and thumb must be provided on both sides of the handrail, at the bottom of the graspable portion, which must not have any sharp edges.

**A-9.8.7.6.(1) Construction Below Handrails.** The By-law allowance for projections below a handrail are intended to accommodate structural supports for the handrails, guards, or other ancillary safety features such as intermediate handrails for children. Such construction may project into the required stair width, but shall not extend more than 100 mm from the top surface of the handrail.



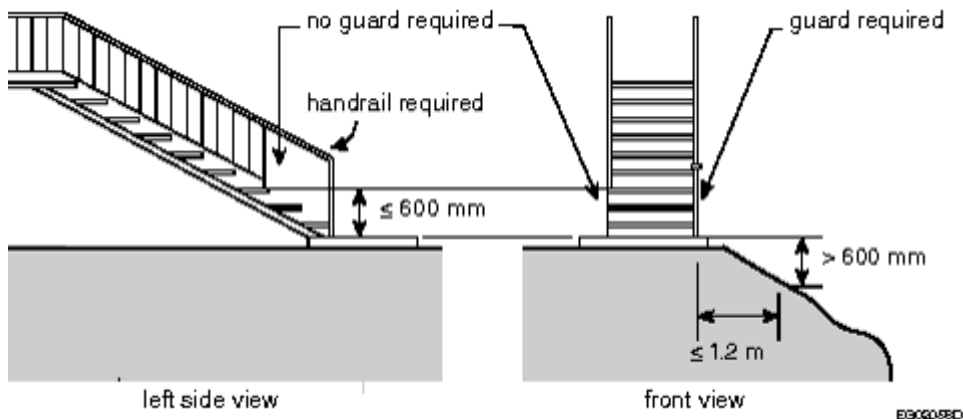


**Figure A-9.8.7.6.(1)**  
**Construction below handrails**

**A-9.8.7.7. Attachment of Handrails.** Handrails are intended to provide guidance and support to the stair user and to arrest falls. The loads on handrails may therefore be considerable. The attachment of handrails serving a single dwelling unit may be accepted on the basis of experience or structural design.

**A-9.8.8.1. Required Guards.** The requirements relating to guards stated in Part 9 are based on the premise that, wherever there is a difference in elevation of 600 mm or more between two floors, or between a floor or other surface to which access is provided for other than maintenance purposes and the next lower surface, the risk of injury in a fall from the higher surface is sufficient to warrant the installation of some kind of barrier to reduce the chances of such a fall. A wall along the edge of the higher surface will obviously prevent such a fall, provided the wall is sufficiently strong that a person cannot fall through it. Where there is no wall, a guard must be installed. Because guards clearly provide less protection than walls, additional requirements apply to guards to ensure that a minimum level of protection is provided. These relate to the characteristics described in Notes A-9.8.8.3., A-9.8.8.5.(1) and (3), A-9.8.8.5.(4) and A-9.8.8.6.(1).

Examples of such surfaces where the difference in elevation could exceed 600 mm and consequently where guards would be required include, but are not limited to, landings, porches, balconies, mezzanines, galleries, and raised walkways. Especially in exterior settings, surfaces adjacent to walking surfaces, stairs or ramps often are not parallel to the walking surface or the surface of the treads or ramps. Consequently, the walking surface, stair or ramp may need protection in some locations but not in others. (See Figure A-9.8.8.1.) In some instances, grades are artificially raised close to walking surfaces, stairs or ramps to avoid installing guards. This provides little or no protection for the users. That is why the requirements specify differences in elevation not only immediately adjacent to the construction but also for a distance of 1.2 m from it. (See Figure A-9.8.8.1.)



**Figure A-9.8.8.1.**

## **Guards for exterior walking surfaces**

**A-9.8.8.1.(4) Window Fall Prevention.** The primary intent of the requirement is to minimize the likelihood of small children falling significant heights from open windows. Reflecting reported cases, the requirement applies to operable windows in dwelling units and generally those located on the second floor or higher of residential or mixed use buildings.

Once cracked open, some operable windows can be opened further by simply pushing on the operable part of the window. Care must be taken in selecting windows, as some with special operating hardware can still be opened further by simply pushing on the window or by deactivating a spring-loaded button or other mechanism that is not considered a window opening control device (WOCD) that could be inadvertently operated by a young child. A technical description of WOCDs can be found in ASTM F2090, "Standard Specification for Window Fall Prevention Devices With Emergency Escape (Egress) Release Mechanisms."

Examples of WOCDs that can limit window openings to a maximum of 100 mm as required by Clause 9.8.8.1.(4)(b) include, but are not limited to, a fixed-stop lever, a fixed-length cable and a fixed-position stop block. It is important to note that rotary opening mechanisms cannot limit window openings to 100 mm as required by Clause 9.8.8.1.(4)(b) and that windows with such mechanisms cannot act as guards as required by Clause 9.8.8.1.(4)(a), even when the crank handle is removed. Similarly, awning windows with scissor hardware may not keep the window from swinging open once it is unlatched. Hopper windows would be affected only if an opening is created at the bottom as well as at the top of the window. The requirement will impact primarily on the use of sliding windows which do not incorporate devices in their construction that can be used to limit the openable area of the window.

The 100 mm opening limit stated in Sentence 9.8.8.1.(4) is recognized as the maximum opening size required to protect small children from falling through open windows. The minimum 900 mm height of the openable portion of windows required by Sentence 9.8.8.1.(5) corresponds to the minimum height of guards required by Sentence 9.8.8.3.(2) as a means of fall protection in residential occupancies.

**A-9.8.8.2. Loads on Guards.** Guards must be constructed so as to be strong enough to protect persons from falling under normal use. Many guards installed in dwelling units or on exterior stairs serving one or two dwelling units have demonstrated acceptable performance over time. The loading described in the first row of Table 9.8.8.2. is intended to be consistent with the performance provided by these guards. Examples of guard construction presented in the "2012 Building Code Compendium, Volume 2, Supplementary Standard SB-7, Guards for Housing and Small Buildings" meet the criteria set in the National Building Code for loads on guards, including the more stringent requirements of Sentences 9.8.8.2.(1) and (3).

The load on guards within dwelling units, or on exterior guards serving not more than two dwelling units, is to be imposed over an area of the guard such that, where standard balusters are used and installed at the maximum 100 mm spacing permitted for required guards, 3 balusters will be engaged. Where the balusters are wider, only two may be engaged unless they are spaced closer together. Where the guard is not required, and balusters are installed more than 100 mm apart, fewer balusters may be required to carry the imposed load.

**A-9.8.8.3. Minimum Heights.** Guard heights are generally based on the waist heights of average persons. Generally, lower heights are permitted in dwelling units because the occupants become familiar with the potential hazards, and situations which lead to pushing and jostling under crowded conditions are less likely to arise.

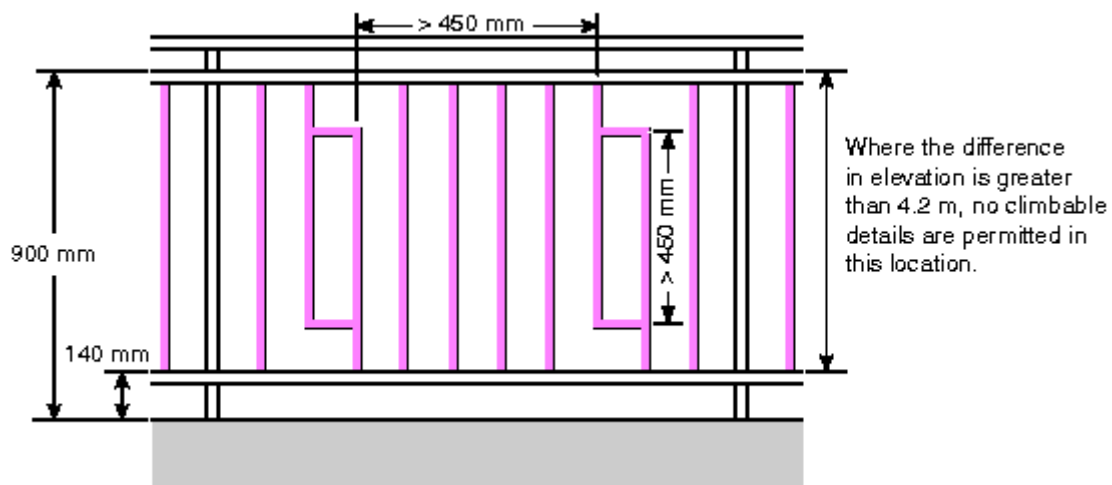
**A-9.8.8.5.(1) and (3) Risk of Falling through Guards.** The risk of falling through a guard is especially prevalent for children. Therefore the requirements are stringent for guards in all

buildings except industrial buildings, where children are unlikely to be present except under strict supervision.

**A-9.8.8.5.(4) Risk of Children Getting Their Head Stuck between Balusters.** The requirements to prevent children falling through guards also serve to provide adequate protection against this problem. However, guards are often installed where they are not required by the By-law; i.e., in places where the difference in elevation is less than 600 mm. In these cases, there is no need to require the openings between balusters to be less than 100 mm. However, there is a range of openings between 100 mm and 200 mm in which children can get their head stuck. Therefore, openings in this range are not permitted except in buildings of industrial occupancy, where children are unlikely to be present except under strict supervision.

**A-9.8.8.6.(1) Configuration of Members, Attachments or Openings in Guards so as to not Facilitate Climbing.** Some configurations of members, attachments or openings may be part of a guard design and still comply with Sentence 9.8.8.6.(1). Figures A-9.8.8.6.(1)-A to A-9.8.8.6.(1)-D present a few examples of designs that are considered to not facilitate climbing.

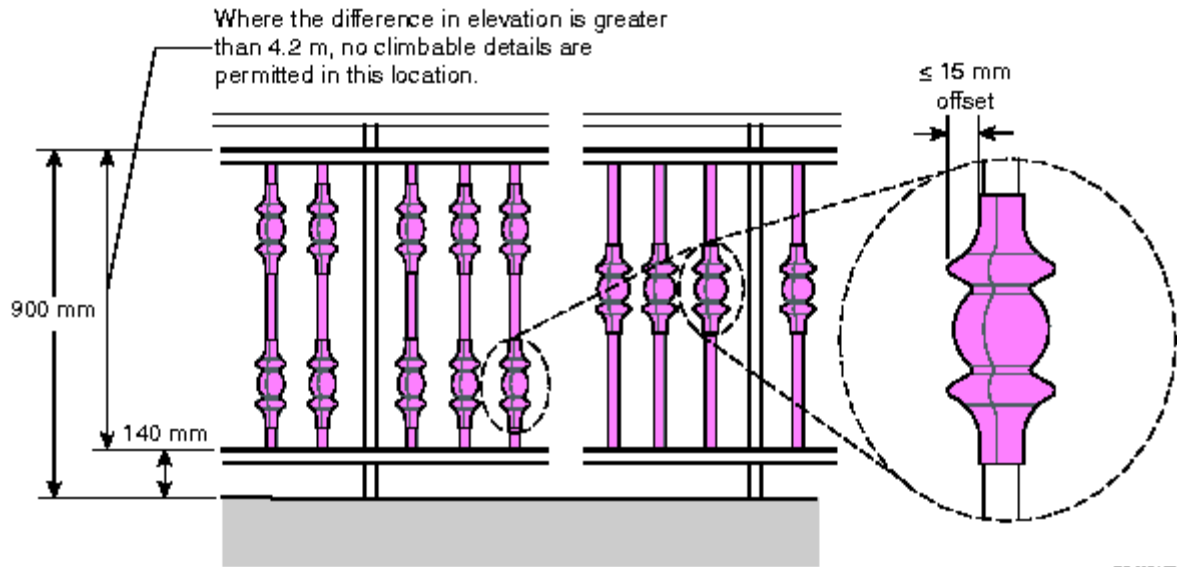
Protrusions that are greater than 450 mm apart horizontally and vertically are considered sufficiently far apart to reduce the likelihood that young children will be able to get a handhold or toehold on the protrusions and climb the guard.



EG021008

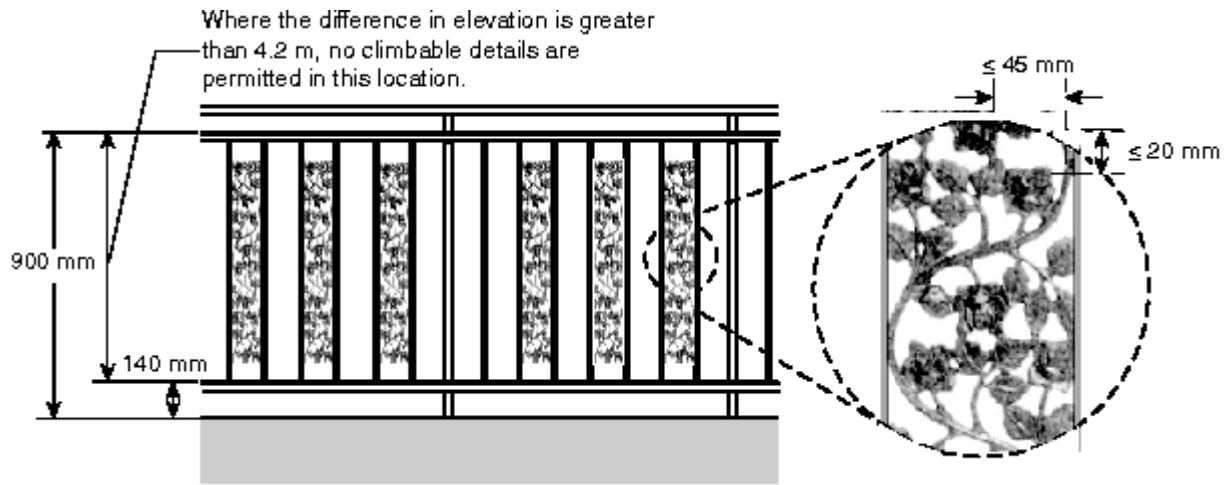
**Figure A-9.8.8.6.(1)-A**  
**Example of minimum horizontal and vertical clearances between protrusions in guards**

Protrusions that present a horizontal offset of 15 mm or less are considered to not provide a sufficient foot purchase to facilitate climbing.



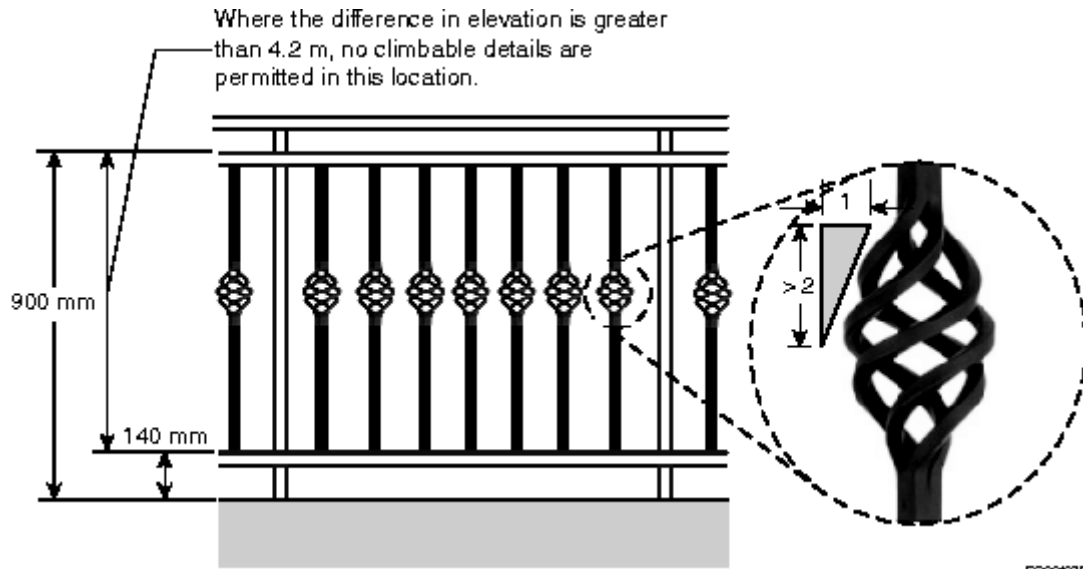
**Figure A-9.8.8.6.(1)-B**  
**Examples of maximum horizontal offset of protrusions in guards**

A guard incorporating spaces that are not more than 45 mm wide by 20 mm high is considered to not facilitate climbing because the spaces are too small to provide a toehold.



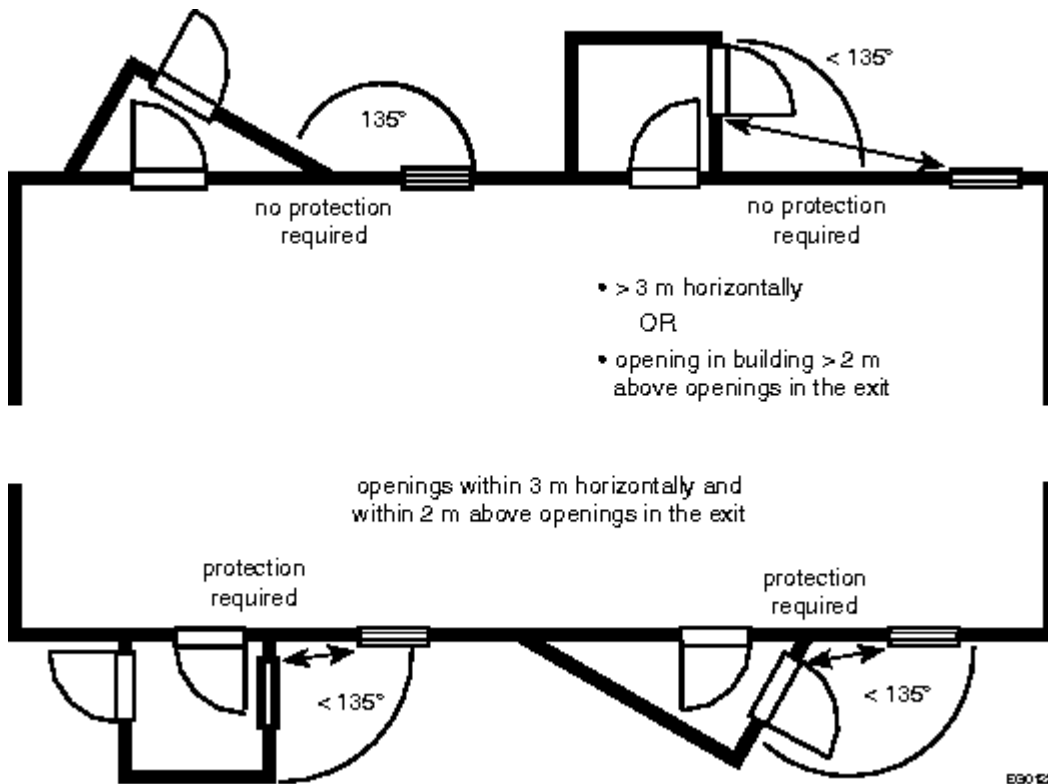
**Figure A-9.8.8.6.(1)-C**  
**Example of a guard with spaces that are not more than 45 mm wide and 20 mm high**

Protrusions that present more than a 2-in-1 slope on the offset are considered to not facilitate climbing because such a slope is considered too steep to provide adequate footing.



**Figure A-9.8.8.6.(1)-D**  
**Example of guard protrusions with a slope greater than 2 in 1**

A-9.9.4.5.(1) Openings in Exterior Walls of Exits.



**Figure A-9.9.4.5.(1)**  
**Protection of openings in exterior walls of exits**

A-9.9.6.4.(6) **Garage Doors Used as a Means of Egress.** The provisions of Sentence 9.9.6.4.(6) are intended to clarify that garage doors intended for vehicular access are not generally permitted to be used as a means of egress. The exception to this, are garage doors designed in conformance

with the requirements of a means of egress. These are typically horizontally swinging garage doors (barn door type).

As with all horizontally swinging egress doors to the exterior, these must consider the potential for snow accumulation or other obstructions which could block or impede their opening in the event of an emergency. This creates practical limitations on the location and width of such doors. Likewise, consideration of door operating conditions must be considered. If automatic hardware for the doors is proposed, this must be readily disengaged or overridden as part of the manual operation of the doors in a manner no more onerous than the disengaging of locking devices that might be placed on any other exterior door from a dwelling unit. Given the variety of concerns that could arise and relative infrequency of such doors, approval by the Chief Building Official is required.

Note that the provisions of this Sentence do not address the related case of swing doors installed in overhead garage doors, which may have additional operational concerns due to the potential for such doors to be jammed during egress or their ability to satisfy accessibility needs. Such cases are not explicitly permitted by the provisions of this By-law.

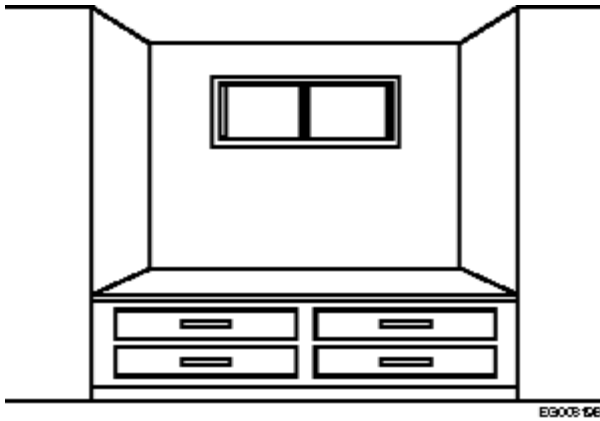
**A-9.9.8.4.(1) Independent and Remote Exits.** Subsection 9.9.8. requires that some floor areas have more than one exit. The intent is to ensure that, if one exit is made untenable or inaccessible by a fire, or its exterior door is blocked by an exterior incident, one or more other exits will be available to permit the occupants to escape. However, if the exits are close together, all exits might be made untenable or inaccessible by the same fire. Sentence 9.9.8.4.(1) therefore requires at least two of the exits to be located remotely from each other. This is not a problem in many buildings falling under Part 9. For instance, apartment buildings usually have exits located at either end of long corridors. However, in other types of buildings (e.g. dormitory and college residence buildings) this is often difficult to accomplish and problems arise in interpreting the meaning of the word "remote." Article 3.4.2.3. is more specific, generally requiring the distance between exits to be one half the diagonal dimension of the floor area or at least 9 m. However, it is felt that such criteria would be too restrictive to impose on the design of all the smaller buildings which come under Part 9. Nevertheless, the exits should be placed as far apart as possible and the Part 3 criteria should be used as a target. Designs in which the exits are so close together that they will obviously both become contaminated in the event of a fire are not acceptable.

**A-9.9.10.1.(1) Escape Windows from Bedrooms.** Sentence 9.9.10.1.(1) generally requires every bedroom in a suite that is not sprinklered to have at least one window or door opening to the outside that is large enough and easy enough to open so that it can be used as an exit in the event that a fire prevents use of the building's normal exits. The minimum unobstructed opening specified for escape windows must be achievable using only the normal window operating procedure. The escape path must not go through nor open onto another room, floor or space.

Where a bedroom is located in a suite that is not sprinklered in a basement, an escape window or door must be located in the bedroom. It is not sufficient to rely on egress through other basement space to another escape window or door.

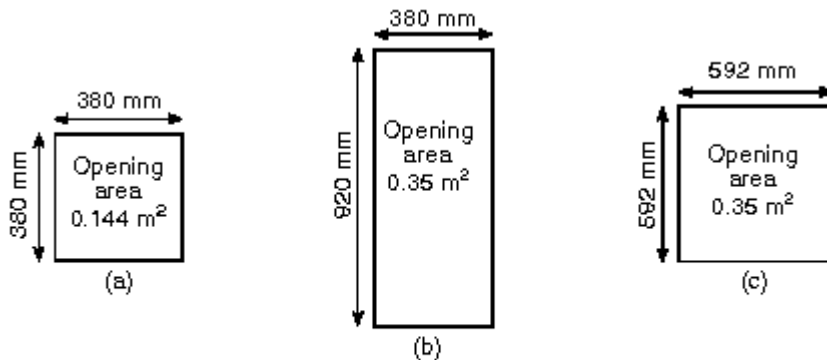
### **Window Height**

Article 9.9.10.1. does not set a maximum sill height for escape windows; it is therefore possible to install a window or skylight that satisfies the requirements of the Article but defeats the Article's intent by virtue of being so high that it cannot be reached for exit purposes. It is recommended that the sills of windows intended for use as emergency exits be not higher than 1.5 m above the floor. However, it is sometimes difficult to avoid having a higher sill: on skylights and windows in basement bedrooms for example. In these cases, it is recommended that access to the window be improved by some means such as built-in furniture installed below the window.



**Figure A-9.9.10.1.(1)**  
**Built-in furniture to improve access to a window**

A-9.9.10.1.(2) Bedroom Window Opening Areas and Dimensions. Although the minimum opening dimensions required for height and width are 380 mm, a window opening that is 380 mm by 380 mm would not comply with the minimum area requirements. (See Figure A-9.9.10.1.(2))



(a) conforms to opening height and width requirements; does not conform to opening area requirements

(b) and (c) conform to height, width and opening area requirements

EG008168

**Figure A-9.9.10.1.(2)**  
**Window opening areas and dimensions**

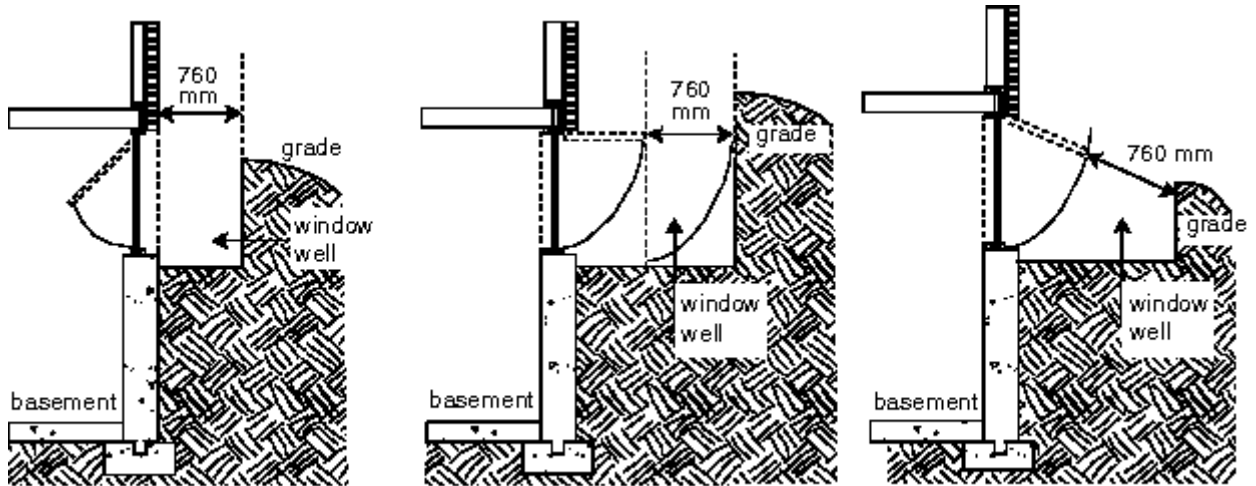
A-9.9.10.1.(3) Window Opening into a Window Well. Sentence 9.9.10.1.(3) specifies that there must be a minimum clearance of 760 mm in front of designated escape windows to allow persons to escape a basement bedroom in an emergency. This specified minimum clearance is consistent with the minimum required width for means of egress from a floor area (see Article 9.9.5.5.) and the minimum required width for path of travel on exit stairs (see Article 9.9.6.1.). It is considered the smallest acceptable clearance between the escape window and the facing wall of the window well that can accommodate persons trying to escape a bedroom in an emergency given that they are not moving straight through the window but must move outward and up, and must have sufficient space to change body orientation.

Once this clearance is provided, no additional clearance is needed for windows with sliders, casements, or inward-opening awnings. However, for windows with outward-opening awnings,

additional clearance is needed to provide the required 760 mm beyond the outer edge of the sash. (See Figure A-9.9.10.1.(3).)

Depending on the likelihood of snow accumulation in the window well, it could be difficult – if not impossible – to escape in an emergency. The window well should be designed to provide sufficient clear space for a person to get out the window and then out the well, taking into account potential snow accumulation.

Hopper windows (bottom-hinged operators) should not be used as escape windows in cases where the occupants would be required to climb over the glass.



**Figure A-9.9.10.1.(3)**  
**Windows providing a means of escape that open into a window well**

**A-9.9.11.5.(1)(d) Colour Contrast.** The identification of floors and other signs intended to facilitate orientation for persons with vision loss should offer maximum colour contrast to be effective. For this reason, it is recommended that white on black or black on white be used, as this combination produces the best legibility. It is also recommended that the sign surfaces be processed to prevent glare.

**A-9.10.1.4.(1) Commercial Cooking Equipment.** Part 6 refers to NFPA 96, “Standard for Ventilation Control and Fire Protection of Commercial Cooking Operations,” which in turn references “Commercial Cooking Equipment.” However, the deciding factor as to whether or not NFPA 96 applies is the potential for production of grease-laden vapours and smoke, rather than the type of equipment used. While NFPA 96 does not apply to domestic equipment for normal residential family use, it should apply to domestic equipment used in commercial, industrial, institutional and similar cooking applications where the potential for the production of smoke and grease-laden vapours exceeds that for normal residential family use.

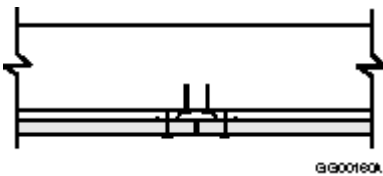
**A-9.10.3.1.(1)(c) Fire and Sound Resistance of Building Assemblies.** Tables 9.10.3.1.-A and 9.10.3.1.-B have been developed from information gathered from tests. While a large number of the assemblies listed were tested, the fire-resistance and acoustical ratings for others were assigned on the basis of extrapolation of information from tests of similar assemblies. Where there was enough confidence relative to the fire performance of an assembly, the fire-resistance ratings were assigned relative to the commonly used minimum ratings of 30 min, 45 min and 1 h, including a designation of “<30 min” for assemblies that are known not to meet the minimum 30-minute rating. Where there was not enough comparative information on an assembly to assign to



it a rating with confidence, its value in the Tables has been left blank (hyphen), indicating that its rating remains to be assessed through another means. Future work is planned to develop much of this additional information.

These Tables are provided only for the convenience of Code users and do not limit the number of assemblies permitted to those in the Tables. The notes to Tables 9.10.3.1.-A and 9.10.3.1.-B are mandatory parts of the Tables and must be used by designers in complying with the design requirements of a particular assembly. Assemblies not listed or not given a rating in these Tables are equally acceptable provided their fire and sound resistance can be demonstrated to meet the above-noted requirements either on the basis of tests referred to in Article 9.10.3.1. and Subsection 9.11.1. or by using the data in Appendix D, Fire-Performance Ratings. It should be noted, however, that Tables 9.10.3.1.-A and 9.10.3.1.-B are not based on the same assumptions as those used in Appendix D. Assemblies in Tables 9.10.3.1.-A and 9.10.3.1.-B are described through their generic descriptions and variants and the important details given in the notes to the Tables. Assumptions for Appendix D include different construction details that must be followed rigorously for the calculated ratings to be expected. These are two different methods of choosing assemblies that meet required fire ratings.

Table 9.10.3.1.-B presents fire-resistance and acoustical ratings for floor, ceiling and roof assemblies. The fire-resistance ratings are appropriate for all assemblies conforming to the construction specifications given in Table 9.10.3.1.-B, including applicable Table notes. Acoustical ratings for assemblies decrease with decreasing depth and decreasing separation of the structural members; the values listed for sound transmission class and impact insulation class are suitable for the minimum depth of structural members identified in the description, including applicable table notes, and for structural member spacing of 305 mm o.c., unless other values are explicitly listed for the assembly. Adjustments to the acoustical ratings to allow for the benefit of deeper or more widely spaced structural members are given in Table Notes (9) and (10).



**Figure A-9.10.3.1.-A**  
**Single layer butt joint details**

**Notes to Figure A-9.10.3.1.-A:**

- (1) Figure is for illustrative purposes only and is not to scale.
- (2) The structural member can be any one of the types described in the Table.
- (3) Adjacent gypsum board butt ends are attached to separate resilient channels using regular Type S screws, located a minimum of 38 mm from the butt end.

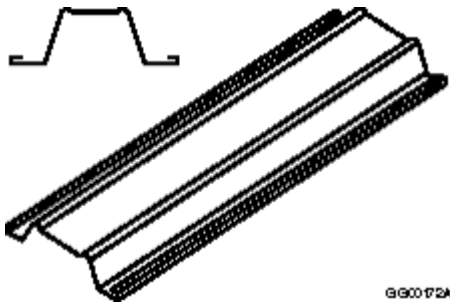


**Figure A-9.10.3.1.-B**  
**Double layer butt joint details**

**Notes to Figure A-9.10.3.1.-B:**

- (1) Figure is for illustrative purposes only and is not to scale.
- (2) The structural member can be any one of the types described in the Table.
- (3) Base layer butt ends can be attached to a single resilient channel using regular Type S screws.

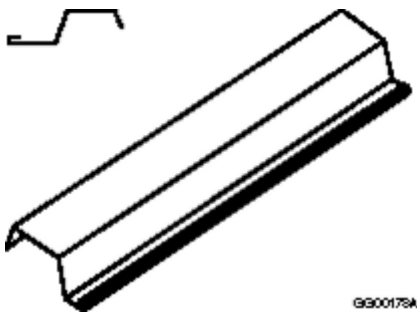
(4) Type G screws measuring a minimum of 32 mm in length and located a minimum of 38 mm from the butt end are used to fasten the butt ends of the face layer to the base layer.



**Figure A-9.10.3.1.-C**  
**Example of steel furring channel**

**Note to Figure A-9.10.3.1.-C:**

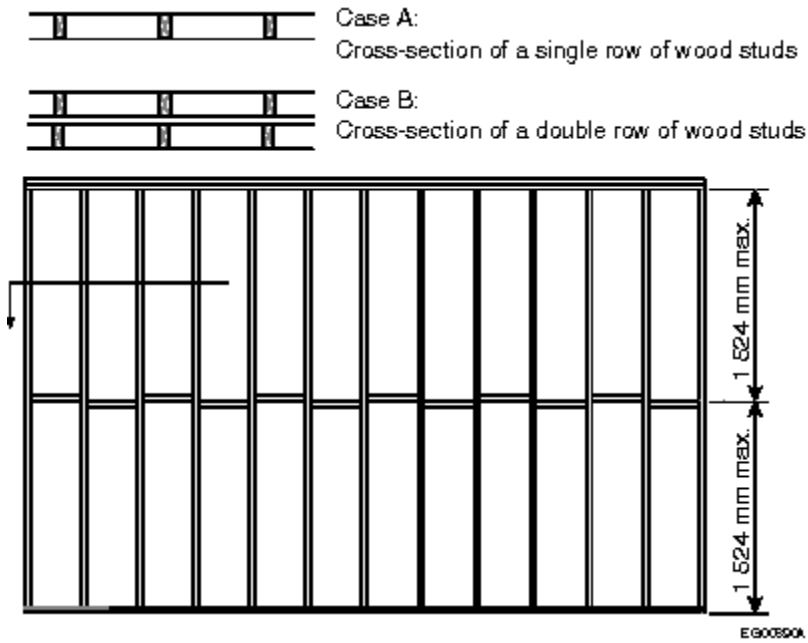
(1) Figure is for illustrative purposes only and is not to scale.



**Figure A-9.10.3.1.-D**  
**Example of resilient metal channel**

**Note to Figure A-9.10.3.1.-D:**

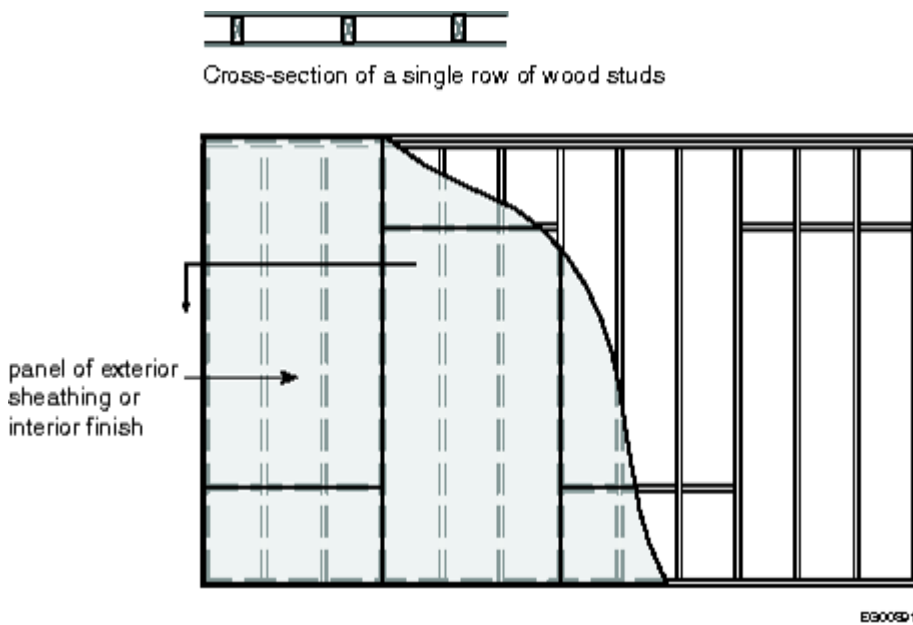
(1) Figure is for illustrative purposes only and is not to scale.



**Figure A-9.10.3.1.-E**  
**Blocking for lightweight wood-frame walls with a single or double row of studs**

**Note to Figure A-9.10.3.1.-E:**

(1) Figure is for illustrative purposes only and is not to scale.



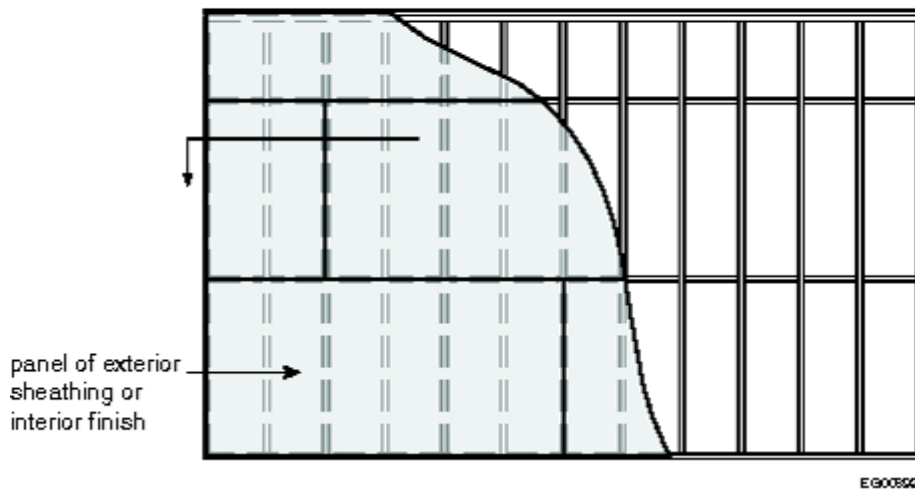
**Figure A-9.10.3.1.-F**  
**Vertical application of exterior wall sheathing or interior wall finish with all joints backed with lumber having the same dimensions as the framing members**

**Note to Figure A-9.10.3.1.-F:**

(1) Figure is for illustrative purposes only and is not to scale.



Cross-section of a single row of wood studs



**Figure A-9.10.3.1.-G**

**Horizontal application of exterior wall sheathing or interior wall finish with all joints backed with lumber having the same dimensions as the framing members**

**Note to Figure A-9.10.3.1.-G:**

(1) Figure is for illustrative purposes only and is not to scale.

**A-9.10.4.1.(4) Mezzanines Not Considered as Storeys.** Mezzanines increase the occupant load and the fire load of the storey of which they are part. To take the added occupant load into account for the purpose of evaluating other requirements that are dependent on this criteria, their floor area is added to the floor area of the storey.

**A-9.10.8.3.(2) Light-frame Construction.** Light-frame walls, columns, arches and beams do not include heavy timber elements or masonry or concrete construction.

**A-9.10.9.3.(2) Openings in Fire Separations with a 15 min Fire-Resistance Rating to be Protected with Closures.** Doors described in Sentence 9.10.9.3.(2) are deemed to provide a minimum 20 min fire-protection rating, which is considered an acceptable level of protection against the spread of fire in a house with a secondary suite. They are not required to be marked to identify conformance to CAN/ULC-S113, "Standard Specification for Wood Core Doors Meeting the Performance Required by CAN/ULC-S104 for Twenty Minute Fire Rated Closure Assemblies," as is the case for solid-core doors installed in fire separations.

**A-9.10.9.6.(1) Penetrations of Fire Separations.** Sentence 9.10.9.6.(1), like Article 3.1.9.1., is intended to ensure that the integrity of fire separations is maintained where they are penetrated by various types of service equipment.

For buildings regulated by Part 3, firestop materials used to seal openings around building services, such as pipes, ducts and electrical outlet boxes, must meet a minimum level of performance demonstrated by standard test criteria.

A similar approach is applied to buildings regulated by Part 9 when complying with Clause 9.10.9.6.(1)(a). In addition, because of the type of construction normally used for Part 9 buildings, it is assumed that the requirement to maintain the integrity of the fire separation is satisfied by the use of generic firestop materials such as mineral wool, gypsum plaster or Portland cement mortar to seal penetrations in accordance with Clause 9.10.9.6.(1)(c).

The use of the terms “tightly fitted” and “cast in place” in Clause 9.10.9.6.(1)(b) is intended to emphasize that there are to be no gaps between the building service or penetrating item and the membrane or assembly it penetrates.

**A-9.10.9.8.(1) Large Recessed Outlet Boxes.** Outlet boxes that exceed the area limits specified in Sentence 9.10.9.8.(2) or (3) do not need to be sealed at the penetration by a firestop in accordance with Sentence 9.10.9.8.(1) if they are installed in a recessed enclosure with a construction that maintains the continuity of the fire-resistance rating of the fire separation or membrane. Any penetrations of the enclosure by wiring or cables must comply with all applicable requirements.

**A-9.10.9.8.(3)(a)(i) Separating Enclosures.** The fire block material separating the outlet box from the adjacent space within the assembly should span the framing members such that all four sides and the back of the outlet box are enclosed by a membrane or framing member conforming to Article 9.10.16.3. Any penetrations of the enclosure by wiring or cables must comply with all applicable requirements. (See also Note A-3.1.11.7.(7).)

**A-9.10.9.18.(4) Separation between Dwelling Units and Storage or Repair Garages.** The gas-tight barrier between a dwelling unit and an attached garage is intended to provide protection against the entry of carbon monoxide and gasoline fumes into the dwelling unit. Building assemblies incorporating an air barrier system will perform adequately with respect to gas tightness, provided all joints in the airtight material are sealed and reasonable care is exercised where the wall or ceiling is pierced by building services. Where a garage is open to the adjacent attic space above the dwelling unit it serves, a gas-tight barrier in the ceiling of the dwelling unit will also provide protection. Unit masonry walls forming the separation between a dwelling unit and an adjacent garage should be provided with two coats of sealer or plaster, or covered with gypsum board on the side of the wall exposed to the garage. All joints must be sealed to ensure continuity of the barrier. (See also Sentences 9.25.3.3.(3) to (8).)

**A-9.10.12.4.(1) Protection of Overhang of Common Roof Space.**

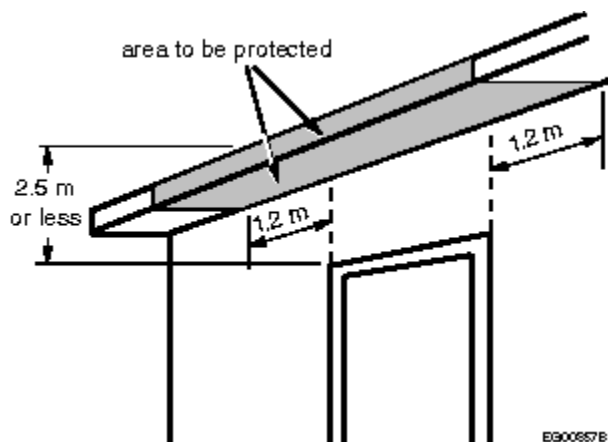


Figure A-9.10.12.4.(1)

#### Protection of overhang of common roof space

**A-9.10.12.4.(3) Protection at Soffits.** The materials required by this Sentence to be used as protection for soffit spaces in certain locations do not necessarily have to be the finish materials. They can be installed either behind the finishes chosen for the soffits or in lieu of these.

**A-9.10.13.2.(1) Wood Doors in Fire Separations.** CAN/ULC-S113, “Standard Specification for Wood Core Doors Meeting the Performance Required by CAN/ULC-S104 for Twenty Minute

Fire Rated Closure Assemblies,” provides construction details to enable manufacturers to build wood core doors that will provide a 20 min fire-protection rating without the need for testing. The standard requires each door to be marked with

- (1) the manufacturer's or vendor's name or identifying symbol,
- (2) the words “Fire Door,” and
- (3) a reference to the fire-protection rating of 20 min.

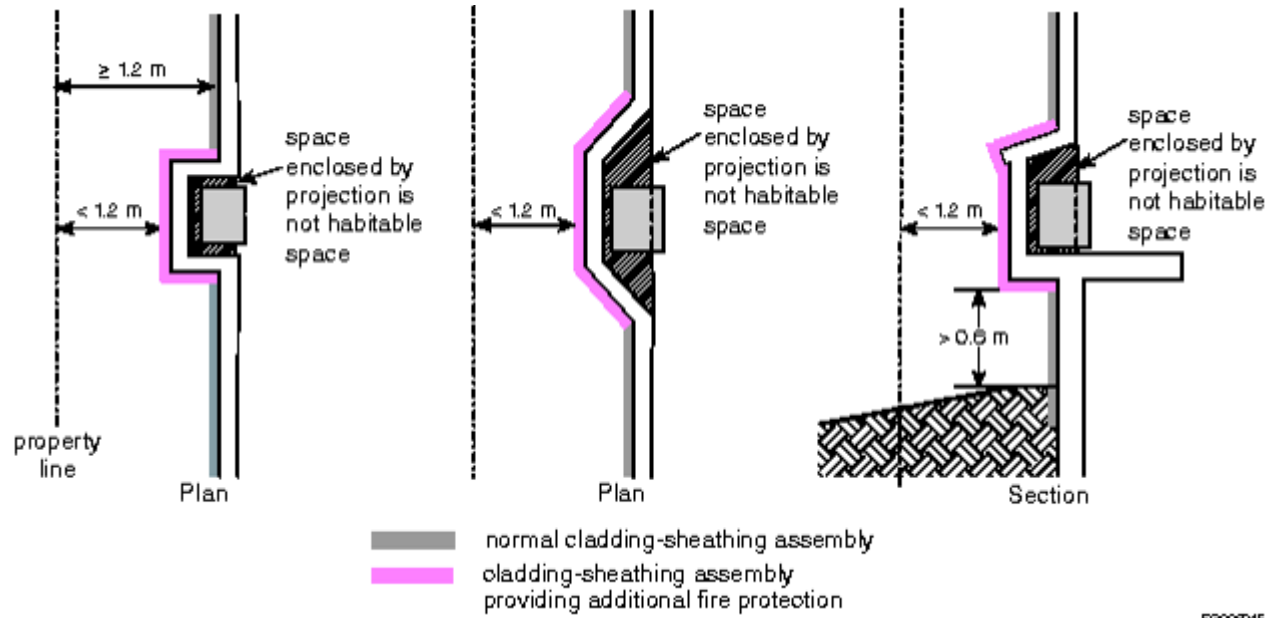
**A-9.10.14.5.(1) Minor Combustible Cladding Elements.** Minor elements of cladding that is required to be noncombustible are permitted to be of combustible material, provided they are distributed over the building face and not concentrated in one area. Examples of minor combustible cladding elements include door and window trim and some decorative elements.

**A-9.10.14.5.(7) Permitted Projections.** The definition of exposing building face provided in Sentence 1.4.1.2.(1) of Division A refers to “that part of the exterior wall of a building ... or, where a building is divided into fire compartments, the exterior wall of a fire compartment ...” Because the exposing building face is defined with respect to the exterior wall, projections from exposing building faces are elements that do not incorporate exterior walls. Depending on their specific configurations, examples of constructions that would normally be permitted by Sentence 9.10.14.5.(7) are balconies, platforms, canopies, eave projections and stairs. However, if a balcony, platform or stair is enclosed, its exterior wall would become part of an exposing building face and the construction could not be considered to be a projection from the exposing building face.

**A-9.10.14.5.(8) Protection at Projections.** Sentence 9.10.14.5.(7) permits certain projections from exposing building faces where the projections do not have exterior walls and thus clearly do not constitute part of the exposing building face. Sentence 9.10.14.5.(8) refers to other types of projections from the exposing building face, such as those for fireplaces and chimneys. It is recognized that these types present more vertical surface area compared to platforms, canopies and eave projections, and may be enclosed by constructions that are essentially the same as exterior walls. These constructions, however, do not enclose habitable space, are of limited width and may not extend a full storey in height. Consequently, Sentence (8) allows these projections beyond the exposing building face of buildings identified in Sentence (6), provided additional fire protection is installed on the projection.

Figure A-9.10.14.5.(8) illustrates projections that extend within 1.2 m of the property line where additional protection must be provided. Where a projection extends within 0.6 m of the property line, it must be protected to the same degree as an exposing building face that has a limiting distance of less than 0.6 m. Where a projection extends to less than 1.2 m but not less than 0.6 m of the property line, it must be protected to the same degree as an exposing building face that has a limiting distance of less than 1.2 m.

Protection is also required on the underside of the projection where the projection is more than 0.6 m above finished ground level, measured at the exposing building face.

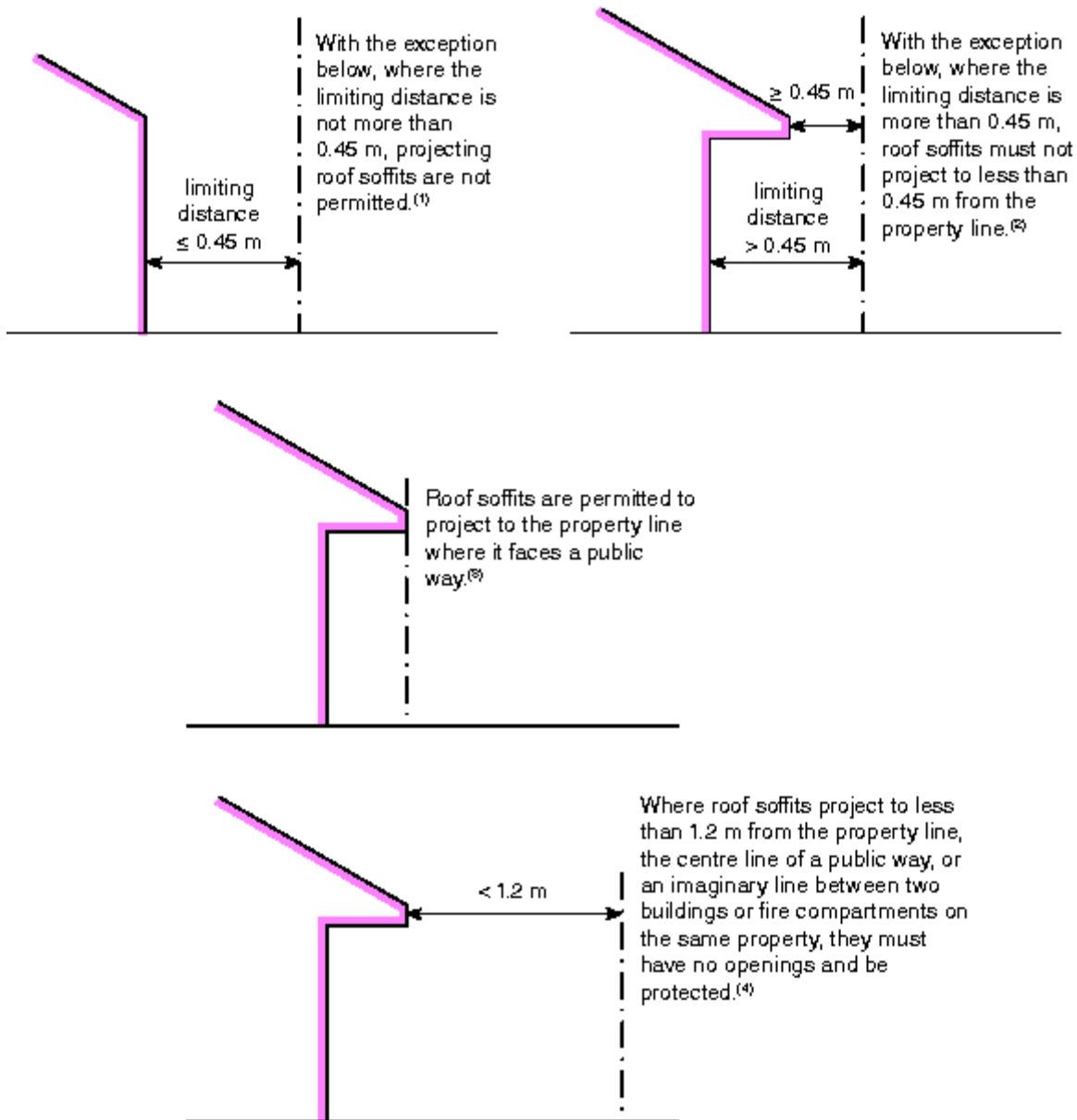


EG00084F

Figure A-9.10.14.5.(8)

Protection at projections

A-9.10.14.5.(11) and 9.10.15.5.(10) Roof Soffit Projections.



ES01270

Figure A-9.10.14.5.(11) and 9.10.15.5.(10)

**Location and protection of projecting roof soffits**

**Notes to Figure A-9.10.14.5.(11) and 9.10.15.5.(10):**

- (1) See Sentences 3.2.3.6.(2), 9.10.14.5.(9) and 9.10.15.5.(8).
- (2) See Sentences 3.2.3.6.(3), 9.10.14.5.(10) and 9.10.15.5.(9).
- (3) See Sentences 3.2.3.6.(4), 9.10.14.5.(11) and 9.10.15.5.(10).
- (4) See Sentences 3.2.3.6.(5), 9.10.14.5.(12) and 9.10.15.5.(11).

**A-9.10.15.1.(1) Application of Subsection 9.10.15.** Subsection 9.10.15. applies to the spatial separation between buildings of residential occupancy where there is no principal dwelling unit,



including its ancillary residential unit, above another dwelling unit. Such buildings include detached houses, semi-detached houses (doubles) and row houses, where there is no dwelling unit above another dwelling unit. The general intent of Vancouver's expanded spatial separation provisions in Subsection 9.10.15. is predicated upon the idea that each legal entity is self-contained and should not overlap (and therefore impact) on an adjacent legal entity and creating complex spatial arrangements that are no longer reflective of a traditional house.

**A-9.10.15.4.(2) Staggered or Skewed Exposing Building Faces of Houses.** Studies at the National Fire Laboratory of the National Research Council have shown that, where an exposing building face is stepped back from the property line or is at an angle to the property line, it is possible to increase the percentage of glazing in those portions of the exposing building face further from the property line without increasing the amount of radiated energy that would reach the property line in the event of a fire in such a building. Figures A-9.10.15.4.(2)-A, A-9.10.15.4.(2)-B and A-9.10.15.4.(2)-C show how Sentences 9.10.15.4.(1) and (2), and 9.10.15.5.(2) and (3) can be applied to exposing building faces that are stepped back from or not parallel to the property line. The following procedure can be used to establish the maximum permitted area of glazed openings for such facades:

1. Calculate the total area of the exposing building face, i.e. facade of the fire compartment, as described in the definition of exposing building face.
2. Identify the portions into which the exposing building face is to be divided. It can be divided in any number of portions, not necessarily of equal size.
3. Measure the limiting distance for each portion. The limiting distance is measured along a line perpendicular to the wall surface from the point closest to the property line.
4. Establish the line in Table 9.10.15.4. from which the maximum permitted percentage area of glazed openings will be read. The selection of the line depends on the maximum area of exposing building face for the whole fire compartment, including all portions, as determined in Step 1.
5. On that line, read the maximum percentage area of glazed openings permitted in each portion of the exposing building face according to the limiting distance for that portion.
6. Calculate the maximum area of glazed openings permitted in each portion. The area is calculated from the percentage found applied to the area of that portion.

Table 9.10.15.4. is used to read the maximum area of glazed openings: this means that the opaque portion of doors does not have to be counted as for other types of buildings.

Note that this Note and the Figures do not describe or illustrate maximum permitted concentrated area or spacing of individual glazed openings, or limits on the location of dividing lines between portions of the exposing building face depending on the location of these openings with respect to interior rooms or spaces. See Sentences 9.10.15.2.(2) and 9.10.15.4.(2) to (4) for the applicable requirements.

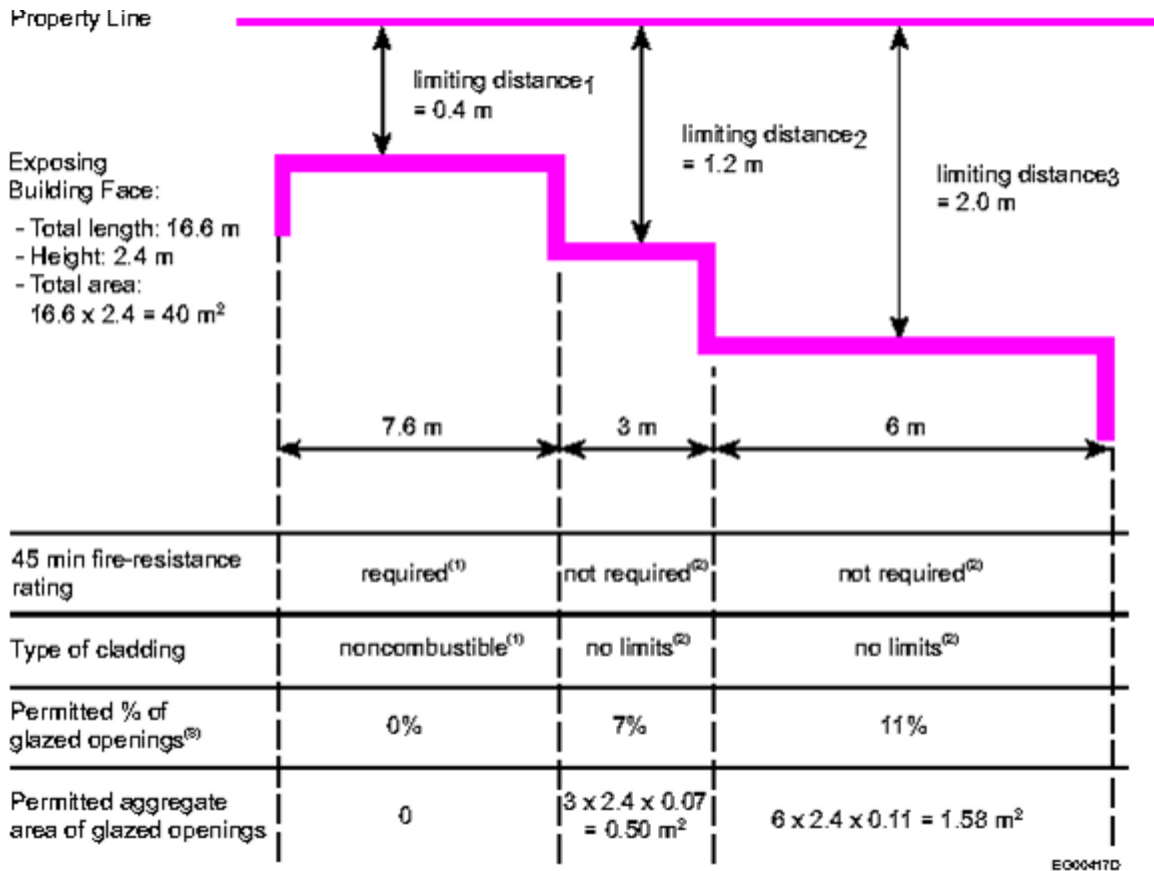


Figure A-9.10.15.4.(2)-A

Example of determination of criteria for the exposing building face of a staggered wall of a house (plan view)

Notes to Figure A-9.10.15.4.(2)-A:

(1) See Sentence 9.10.15.5.(2).

(2) See Sentence 9.10.15.5.(3).

(3) See Table 9.10.15.4., Subclause 9.10.15.2.(1)(b)(iii) and Sentence 9.10.15.4.(2).

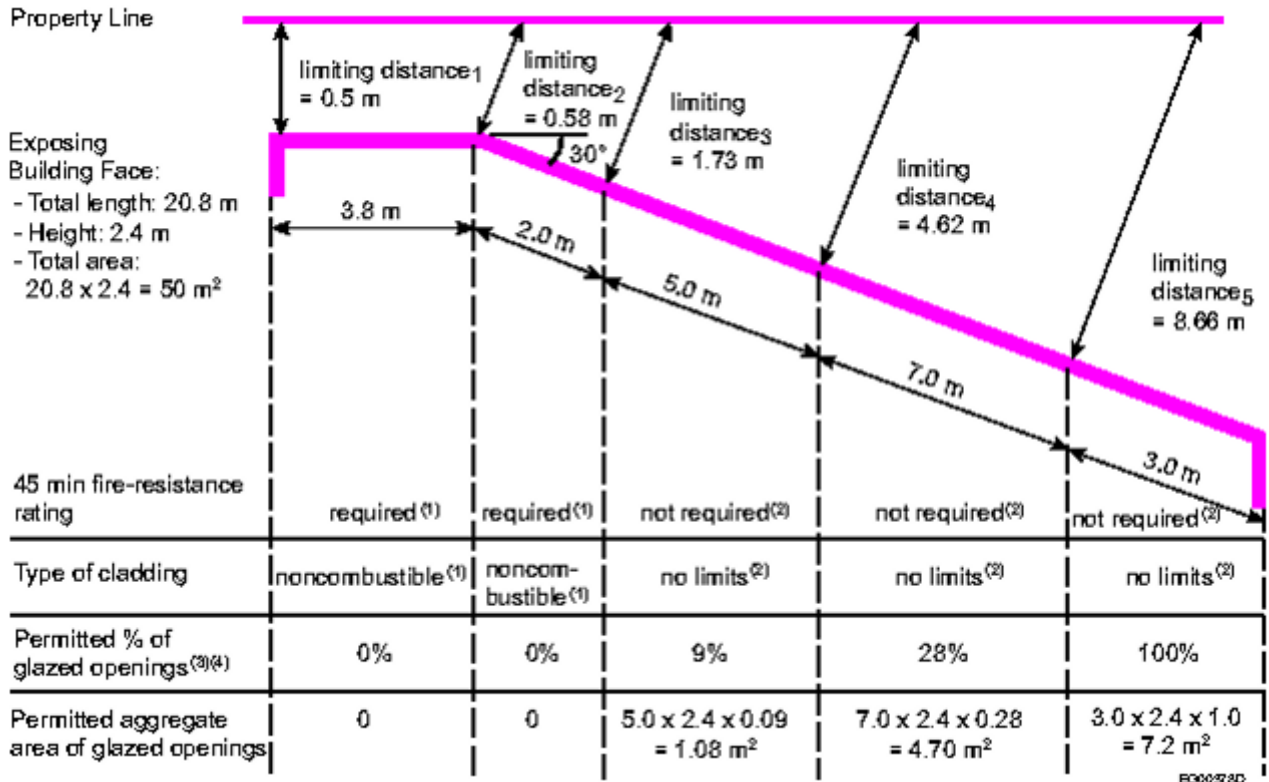


Figure A-9.10.15.4.(2)-B

Example of determination of criteria for the exposing building face of a skewed wall of a house with some arbitrary division of the wall (plan view)

**Notes to Figure A-9.10.15.4.(2)-B:**

- (1) See Sentence 9.10.15.5.(2).
- (2) See Sentence 9.10.15.5.(3).
- (3) See Table 9.10.15.4., Subclause 9.10.15.2.(1)(b)(iii) and Sentence 9.10.15.4.(2).
- (4) To simplify the calculations, choose the column for the lesser limiting distance nearest to the actual limiting distance. Interpolation for limiting distance is also acceptable and may result in a slightly larger permitted area of glazed openings. Interpolation can only be used for limiting distances greater than 1.2 m.

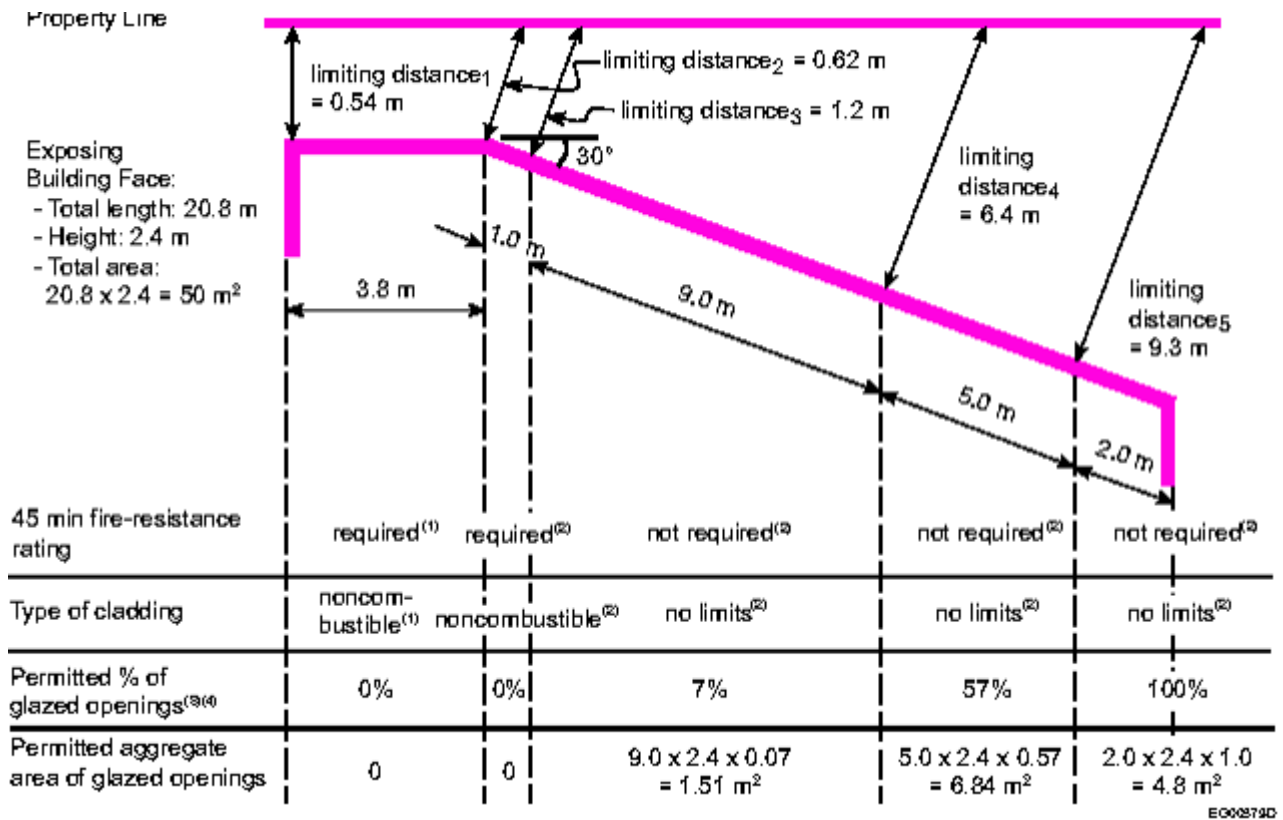


Figure A-9.10.15.4.(2)-C

Example of determination of criteria for the exposing building face of a house with a different arbitrary division of the wall (plan view)

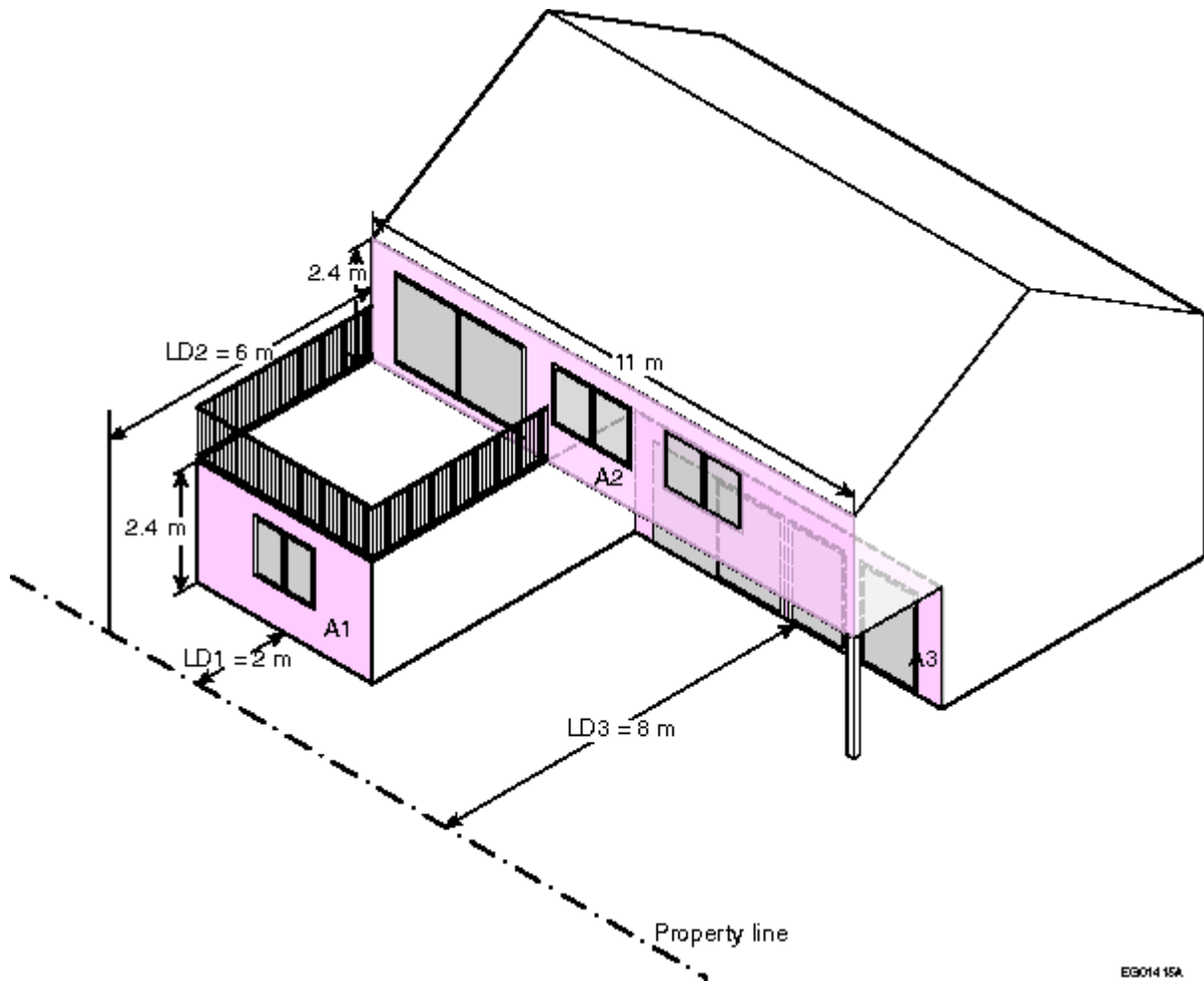
**Notes to Figure A-9.10.15.4.(2)-C:**

- (1) See Sentence 9.10.15.5.(2).
- (2) See Sentence 9.10.15.5.(3).
- (3) See Table 9.10.15.4., Subclause 9.10.15.2.(1)(b)(iii) and Sentence 9.10.15.4.(2).
- (4) To simplify the calculations, choose the column for the lesser limiting distance nearest to the actual limiting distance. Interpolation for limiting distance is also acceptable and may result in a slightly larger permitted area of glazed openings. Interpolation can only be used for limiting distances greater than 1.2 m.

Table A-9.10.15.4.(2)

**Example of Determination of Maximum Area of Glazed Openings for the Exposing Building Face (EBF) of a House with a Setback Wall Using Figure A-9.10.15.4.(2)-D**

Portion of EBF	Area of Each Portion of EBF	Limiting Distance of Each Portion of EBF	Permitted % of Glazed Openings Based on Total Area of EBF (52.8 m <sup>2</sup> ) and Limiting Distance of Each Portion of EBF Using Table 9.10.15.4.	Permitted Area of Glazed Openings for Each Portion of EBF
A1	4 m x 2.4 m = 9.6 m <sup>2</sup>	LD1 = 2 m	10%	9.6 m <sup>2</sup> x 10% = 0.96 m <sup>2</sup>
A2	11 m x 2.4 m = 26.4 m <sup>2</sup>	LD2 = 6 m	57%	26.4 m <sup>2</sup> x 57% = 15.05 m <sup>2</sup>
A3	7 m x 2.4 m = 16.8 m <sup>2</sup>	LD3 = 8 m	100%	16.8 m <sup>2</sup> x 100% = 16.8 m <sup>2</sup>



EG9014 15A

**Figure A-9.10.15.4.(2)-D**

**Example of determination of criteria for the exposing building face of a house with a setback wall (perspective view)**

**Note to Figure A-9.10.15.4.(2)-D:**

(1) LD = limiting distance; A = area.

**A-9.10.15.4.(11) Small Attached Carports or Garages Ancillary to a Residential Building** An attached carport or open-air storage garage located beneath building floor area and supporting the storage of vehicles form a part of the building regardless of whether or not this is substantially open. As such, they are required to comply with the spatial separation requirements of the Building By-law, typically Division B, Subsections 9.10.14. or 9.10.15.

These types of storage garages are typically small, and serve small multiplex and duplex buildings, located on a small site with severe competition for ground level access. Where these types of garages can be shown to serve a limited number of vehicles and are substantially open, the Chief Building Official may permit 100% unprotected openings where the design incorporates the additional fire safety features described in Sentence 9.10.15.4.(11).

#### Cross Ventilation

The fire protection requirements of Sentence 9.10.15.4.(11) recognize that the open-air nature of attached carports or open-air storage garages, which are not typically subject to the same degree

of fire intensity and smoke entrapment they are within an enclosed interior space. This assumption is dependent upon the degree of openness and the availability of cross-ventilation in order to ensure that the products of combustion are not confined, and which could increase the severity of a fire. Consequently, the arrangement of the parking should be such that it avoids the creation of barriers that would impede the free movement of the products of combustion resulting from a fire.

### Spatial Separation

Multiplex buildings are fully residential, and generally contain a small number of suites with a combined floor area consistent with traditional detached houses or duplexes. Sprinklers are already required under covered areas where storage is expected by NFPA 13 and its derivative standards. The provisions of Sentence 9.10.15.4.(11) provide for supplemental minimum water delivery requirements that are broadly consistent with the protection of storage garages in other larger multi-family residential buildings. This is intended to contain a fire and its effect to the area of origin, thereby reducing the concerns related to unprotected openings.

### Resiliency and Subsidiary Uses

The enhanced fire separation and sprinkler requirements espoused by these provisions are intended to limit the likelihood of fire spread into the attached residential units. This is intended to provide greater containment of a fire until the fire department can arrive and begin suppression operations and may also reduce the likelihood of occupants being displaced following a fire.

**A-9.10.19.3.(1) Location of Smoke Alarms.** There are two important points to bear in mind when considering where to locate smoke alarms in dwelling units:

- The most frequent point of origin for fires in dwelling units is the living area.
- The main concern in locating smoke alarms is to provide warning to people asleep in bedrooms.

A smoke alarm located in the living area and wired so as to sound another smoke alarm located near the bedrooms is the ideal solution. However, it is difficult to define exactly what is meant by “living area.” It is felt to be too stringent to require a smoke alarm in every part of a dwelling unit that could conceivably be considered a “living area” (living room, family room, study, etc.). Sentence 9.10.19.3.(1) addresses these issues by requiring at least one smoke alarm on every storey containing a sleeping room. Thus, in a dwelling unit complying with Sentence 9.10.19.3.(1), every living area will probably be located within a reasonable distance of a smoke alarm. Nevertheless, where a choice arises as to where on a storey to locate the required smoke alarm or alarms, one should be located as close as possible to a living area, provided the requirements related to proximity to bedrooms are also satisfied.

A smoke alarm is not required on each level in a split-level dwelling unit as each level does not count as a separate storey. Determine the number of storeys in a split-level dwelling unit and which levels are part of which storey as follows:

1. establish grade, which is the lowest of the average levels of finished ground adjoining each exterior wall of a building;
2. identify the first storey, which is the uppermost storey having its floor level not more than 2 m above grade;
3. identify the basement, which is the storey or storeys located below the first storey;
4. identify the second storey and, where applicable, the third storey.

As a minimum, one smoke alarm is required to be installed in each storey, preferably on the upper level of each one. As noted above, however, when the dwelling unit contains more than one sleeping area, an alarm must be installed to serve each area. Where the sleeping areas are on two levels of a single storey in a split-level dwelling unit, an additional smoke alarm must be installed so that both areas are protected. See Figure A-9.10.19.3.(1).

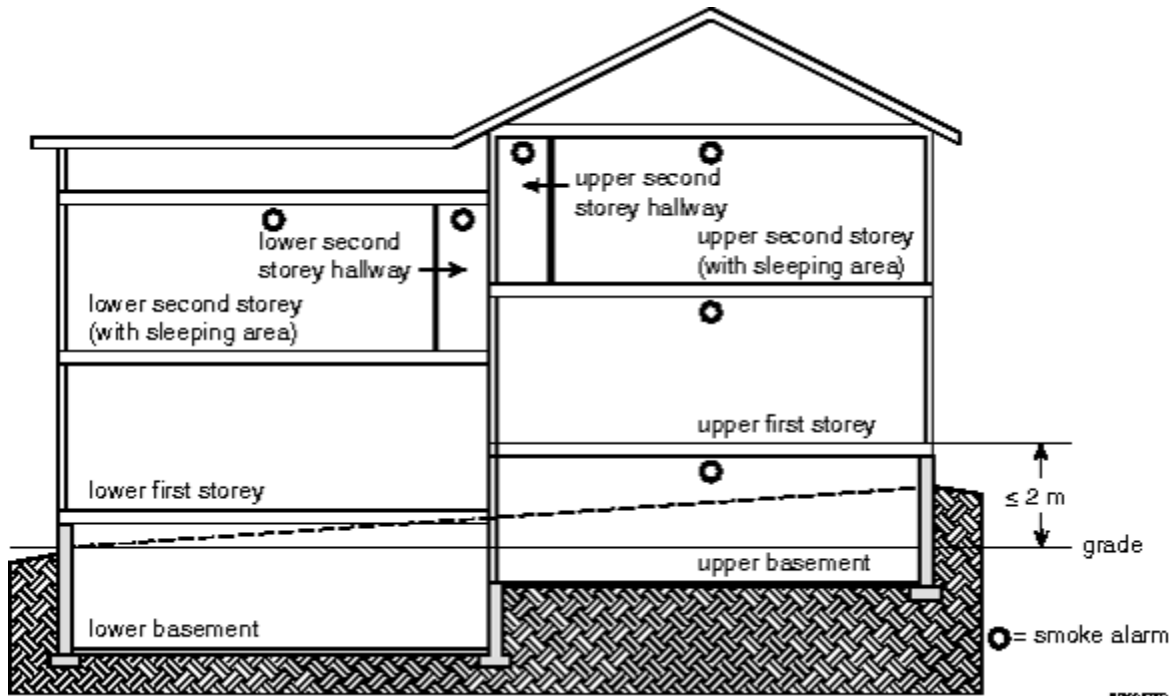


Figure A-9.10.19.3.(1)

**Location of smoke alarms in a two-storey split-level dwelling unit**

**Notes to Figure A-9.10.19.3.(1):**

- (1) One smoke alarm required for each of the basement, first storey and second storey.
- (2) An additional smoke alarm is required on the lower level of the second storey outside the sleeping rooms.

**A-9.10.20.3.(1) Fire Department Access Route Modification.** In addition to other considerations taken into account in the planning of fire department access routes, special variations could be permitted for a house or residential building that is protected with an automatic sprinkler system. The sprinkler system must be designed in accordance with the appropriate NFPA standard and there must be assurance that water supply pressure and quantity are unlikely to fail. These considerations could apply to buildings that are located on the sides of hills and are not conveniently accessible by roads designed for firefighting equipment and also to infill housing units that are located behind other buildings on a given property.

**A-9.10.22. Clearances from Gas, Propane and Electric Cooktops.** CSA C22.1, "Canadian Electrical Code, Part I," and CSA B149.1, "Natural gas and propane installation code," address clearances directly above, in front of, behind and beside the appliance. Where side clearances are zero, the standards do not address clearances to building elements located both above the level of the cooktop elements or burners and to the side of the appliance. Through reference to the above noted regulations and their adopted standards, and the requirements in Articles 9.10.22.2. and 9.10.22.3., the NBC addresses all clearances. Where clearances are addressed by the British

Columbia Building Code and the above noted regulations and their adopted standards, conformance with all relevant criteria is achieved by compliance with the most stringent criteria.

Figure A-9.10.22. illustrates the minimum clearances addressed in Subsection 9.10.22.

### Installation of Microwave Ovens Over Cooktops

The minimum vertical clearances stated in Article 9.10.22.2. apply only to combustible framing, finishes and cabinets. They do not apply to microwave ovens installed over cooktops nor to range hoods. The "Canadian Electrical Code, Part I" requires that microwave ovens comply with CAN/CSA-C22.2 No. 150, "Microwave Ovens." This standard includes tests to confirm that the appliance will not present a hazard when installed according to the manufacturer's instructions.

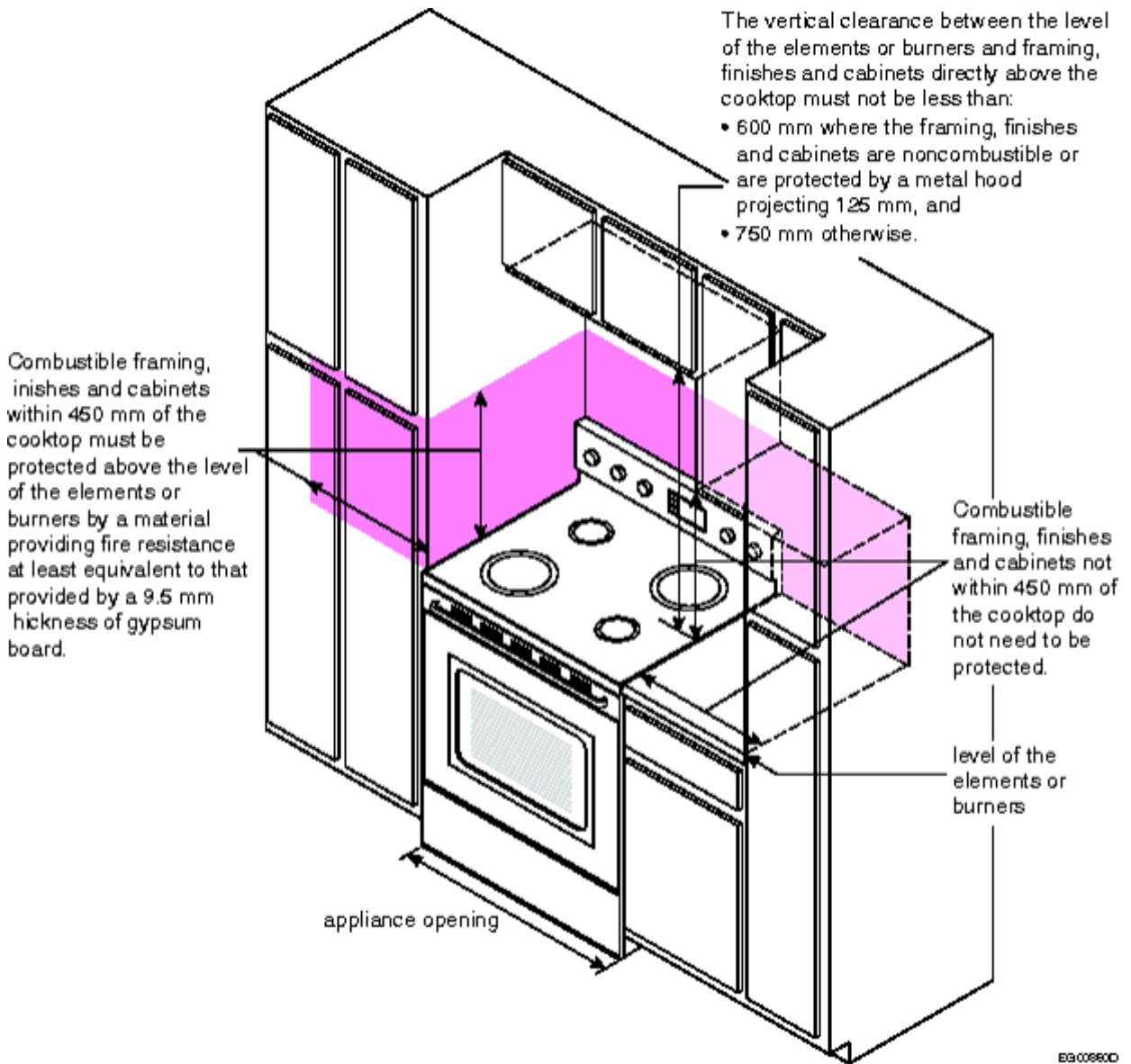


Figure A-9.10.22.

Minimum clearances from cooktops and protection of walls and cabinetry



## A-9.11. Sound Transmission.

### Airborne Sound

Airborne sound is transmitted between adjoining spaces directly through the separating wall, floor and ceiling assemblies and via the junctions between these separating assemblies and the flanking assemblies.

The Sound Transmission Class (STC) rating describes the performance of the separating wall or floor/ceiling assembly, whereas the Apparent Sound Transmission Class (ASTC) takes into consideration the performance of the separating element as well as the flanking transmission paths. Therefore, from the occupants' point of view, the best indicator of noise protection between two spaces is the ASTC rating.

As a key principle, it is important to follow a “whole-system” approach when designing or constructing assemblies that separate dwelling units because the overall sound performance of walls and floors is also influenced by fire protection measures and the structural design of the assemblies. Likewise, changes to the construction of assemblies to meet sound transmission requirements may have fire and structural implications. Another key principle is that enhancing the performance of the separating element does not automatically enhance the system's performance.

For horizontally adjoining spaces, the separating assembly is the intervening wall and the pertinent flanking surfaces include those of the floor, ceiling, and side wall assemblies that have junctions with the separating wall assembly, normally at its four edges. For each of these junctions, there is a set of sound transmission paths. Figure A-9.11.-A illustrates the horizontal sound transmission paths at the junction of a separating wall with flanking floor assemblies.

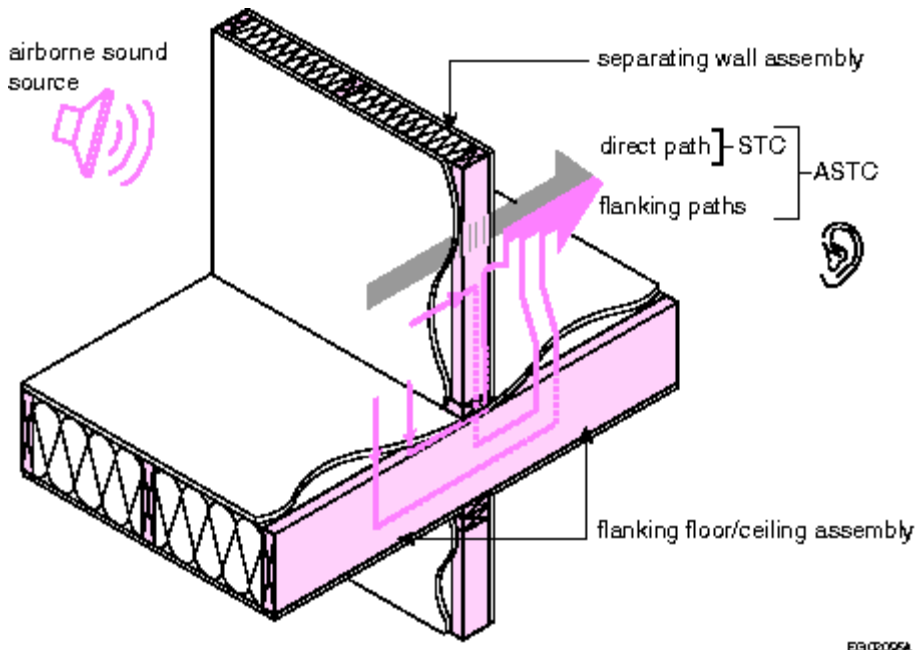


Figure A-9.11.-A

### Horizontal sound transmission paths at floor/wall junction

For vertically adjoining spaces, the separating assembly is the intervening floor/ceiling and the pertinent flanking surfaces include those of the side wall assemblies in the upper and lower

rooms that have junctions with the separating floor/ceiling assembly at its edges, of which there are normally four. For each of these junctions, there is a set of sound transmission paths. Figure A-9.11.-B illustrates the vertical sound transmission paths at the junction of a separating floor/ceiling assembly with two flanking wall assemblies.

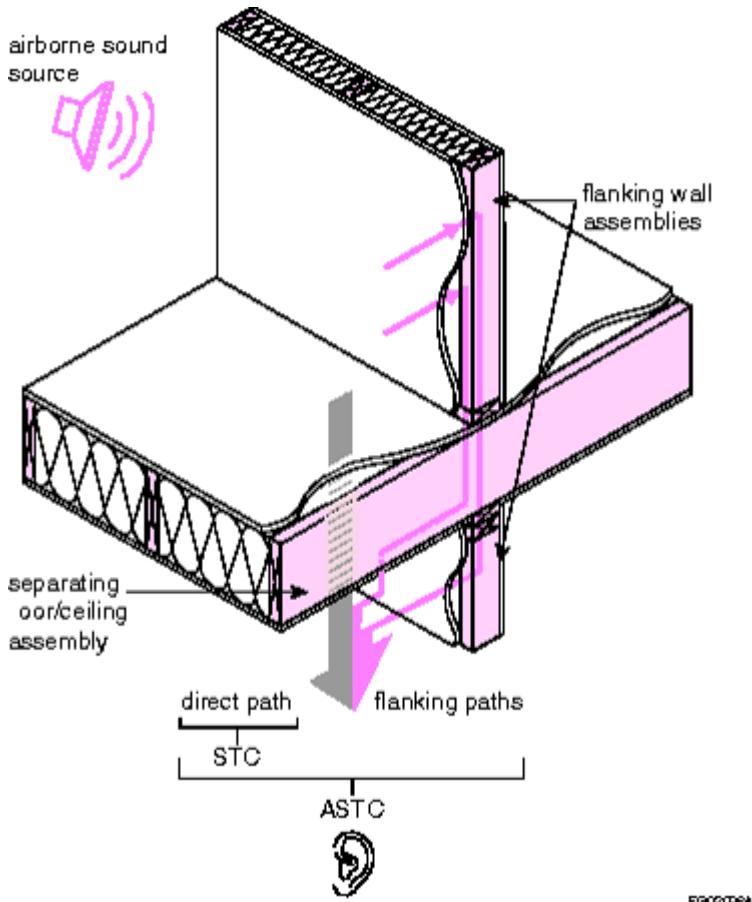


Figure A-9.11.-B

### Vertical sound transmission paths at wall/floor junction

#### Control of Sound Leaks

The metrics used to characterize the sound transmission performance of assemblies separating dwelling units do not account for the adverse effects of air leaks in those assemblies, which can transfer sound. Sound leaks can occur where a wall meets another wall, the floor, or the ceiling. They can also occur where wall finishes are cut to allow the installation of equipment or services. The following are examples of measures for controlling sound leaks:

- avoid back-to-back electrical outlets or medicine cabinets;
- carefully seal cracks or openings so structures are effectively airtight;
- apply sealant below the plates in stud walls, between the bottom of gypsum board and the structure behind, around all penetrations for services and, in general, wherever there is a crack, a hole or the possibility of one developing;
- include sound-absorbing material inside the wall if not already required

The reduction of air leakage is also addressed to some extent by the smoke tightness requirements in the Code.

The NRC report entitled “Best Practice Guide on Fire Stops and Fire Blocks and their Impact on Sound Transmission,” provides additional information regarding the possible impacts of fire protection measures on sound transmission.

The calculation of and laboratory testing for STC and ASTC ratings are performed on intact assemblies having no penetrations or doors. When measuring ASTC ratings in the field, openings can be blocked with insulation and drywall.

To verify that the required acoustical performance is being achieved, a field test can be done at an early stage of construction. ASTM E336, “Standard Test Method for Measurement of Airborne Sound Attenuation between Rooms in Buildings,” gives a complete measurement. A simpler and less expensive method is presented in ASTM E597, “Practice for Determining a Single Number Rating of Airborne Sound Insulation for Use in Multi-Unit Building Specifications.” The rating derived from this test is usually within 2 points of the STC obtained from ASTM E336. It is useful for verifying performance and finding problems during construction. Alterations can then be made prior to project completion.

### **Impact Noise**

Section 9.11. has no requirements for the control of impact noise transmission. However, footsteps and other impacts can cause severe annoyance in multifamily residences. Builders concerned about quality and reducing occupant complaints will ensure that floors are designed to minimize impact transmission. A recommended criterion is that bare floors (tested without a carpet) should achieve an impact insulation class (IIC) of 55. Some lightweight floors that satisfy this requirement may still elicit complaints about low frequency impact noise transmission. Adding carpet to a floor will always increase the IIC rating but will not necessarily reduce low frequency noise transmission. Good footstep noise rejection requires fairly heavy floor slabs or floating floors.

The most frequently used test methods for impact noise are ASTM E492, “Standard Test Method for Laboratory Measurement of Impact Sound Transmission Through Floor-Ceiling Assemblies Using the Tapping Machine,” and ASTM E1007, “Standard Test Method for Field Measurement of Tapping Machine Impact Sound Transmission Through Floor-Ceiling Assemblies and Associated Support Structures.”

### **Machinery Noise**

Elevators, garbage chutes, plumbing, fans, and heat pumps are common sources of noise in buildings. To reduce annoyance from these, they should be placed as far as possible from sensitive areas. Vibrating parts should be isolated from the building structure using resilient materials such as neoprene or rubber.

A-9.11.1.1.(2) Sound Transmission in Houses with a Secondary Suite. Controlling sound transmission between dwelling units is important to the occupants' health and well-being. Although this may be difficult to achieve in an existing building, it is nevertheless necessary that a minimum level of sound transmission protection be provided between the dwelling units in a house with a secondary suite. A somewhat reduced level of performance is acceptable in the case of secondary suites because the occupants of the house containing a secondary suite are only affected by the sound of one other unit and, in many cases, it is the owner of the house who will decide on the desired level of protection. Sound resistance can be improved by selecting furnishings and finishings that absorb sound, such as carpet.

**A-9.11.1.3.(2)(b) Control of Airborne Noise in Buildings.** Tables 9.10.3.1.-A and 9.10.3.1.-B present separating assemblies that comply with Section 9.11. However, selecting an appropriate separating assembly is only one part of the solution for reducing airborne sound transmission between adjoining spaces: to fully address the sound performance of the whole system, flanking assemblies must be connected to the separating assembly in accordance with Article 9.11.1.4.

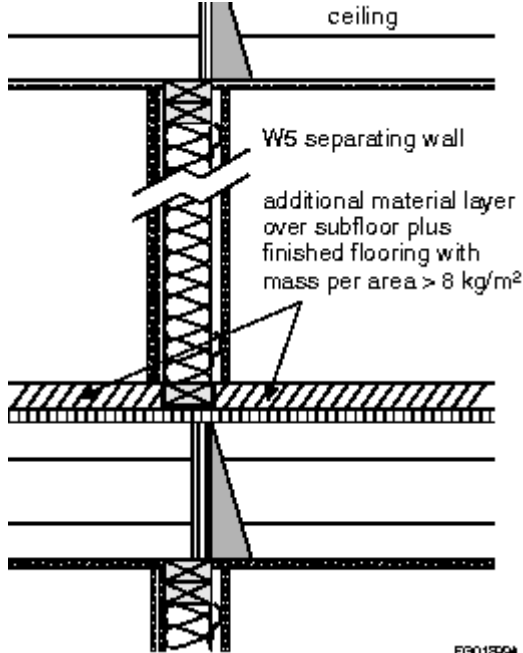
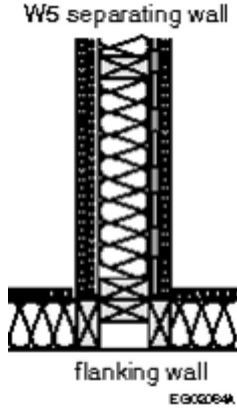
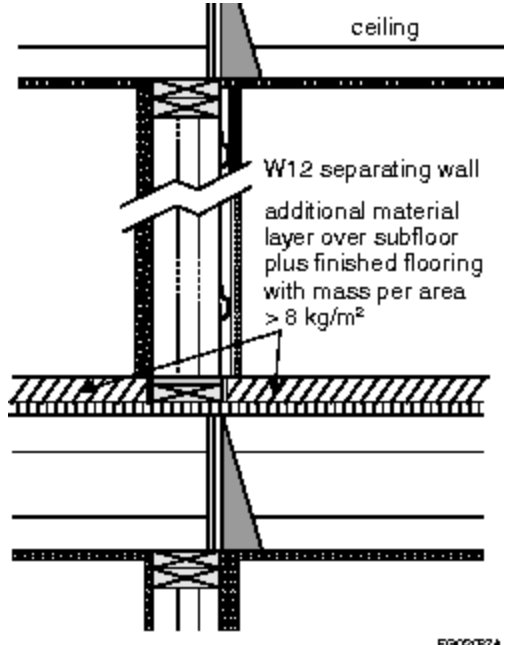
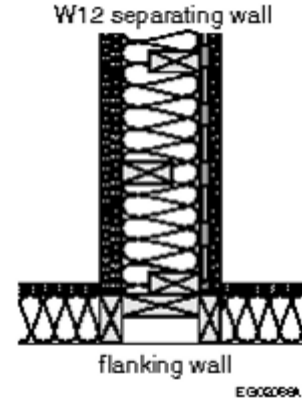
**A-9.11.1.4. Adjoining Constructions.** Tables A-9.11.1.4.-A to A-9.11.1.4.-D present generic options for the design and construction of junctions between separating and flanking assemblies. Constructing according to these options is likely to meet or exceed an ASTC rating of 47. Other designs may be equally acceptable if their sound resistance can be demonstrated to meet the minimum ASTC rating or better on the basis of tests referred to in Article 9.11.1.2., or if they comply with Subsection 5.8.1. However, some caution should be applied when designing solutions that go beyond the options provided in these Tables: for example, adding more material to a wall could negatively impact its sound performance or have no effect at all.

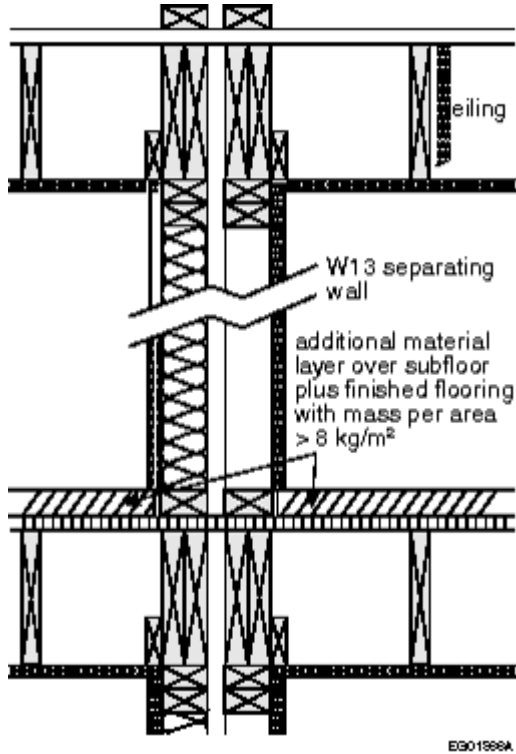
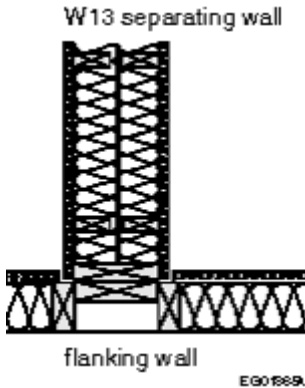
Table A-9.11.1.4.-A presents compliance options for the construction of separating wall assemblies with flanking floor, ceiling and wall assemblies in horizontally adjoining spaces.

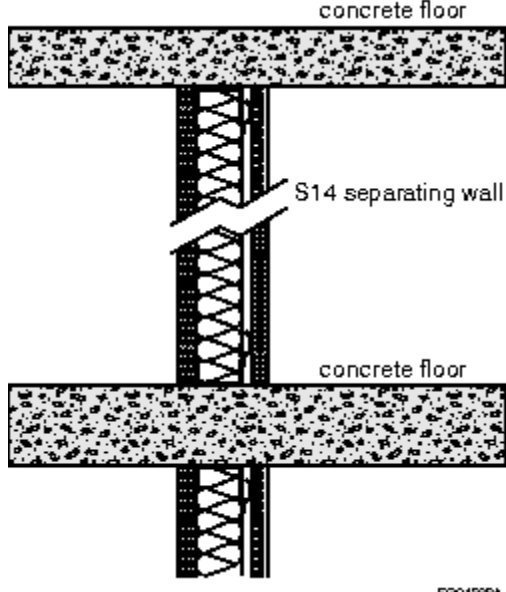
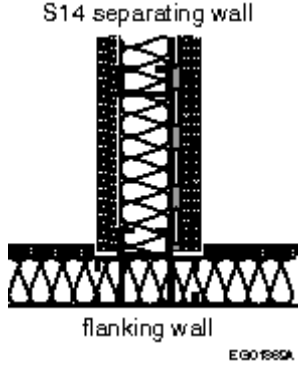
**Table A-9.11.1.4.-A**

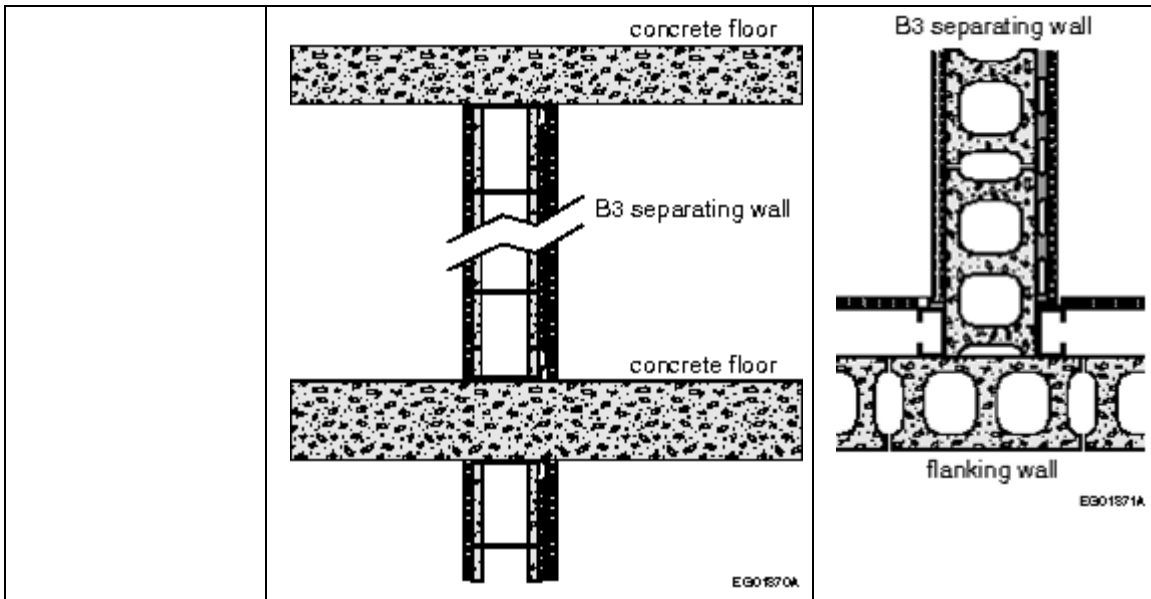
**Options for the Design and Construction of Junctions and Flanking Surfaces Between Separating Wall Assemblies in Horizontally Adjoining Spaces for Compliance with Clause 9.11.1.1.(1)(b)**

Type of Separating Wall Assembly with $STC \geq 50$ from Table 9.10.3.1.-A	Options for Design and Construction of Junctions and Flanking Surfaces <sup>(a)</sup> to Address Horizontal Sound Transmission Paths		
	Bottom Junction (between separating wall and flanking floors)	Top Junction (between separating wall and flanking ceiling)	Side Junctions (between separating wall and flanking walls)
W4, W5, W6 (single stud) W8, W9, W10, W11, W12 (staggered studs)	<ul style="list-style-type: none"> <li>for additional material layer and finished flooring, see Table 9.11.1.4.</li> <li>subfloor on both sides of wall is plywood, OSB, waferboard (15.5 mm thick) or tongue and groove lumber (<math>\geq 17</math> mm thick)</li> <li>floor is framed with wood joists, wood I-joists or wood trusses spaced <math>\geq 400</math> mm o.c., with or without absorptive material<sup>(a)</sup> in cavities</li> <li>floor joists or trusses are oriented parallel to separating wall (non-loadbearing case) or perpendicular to separating wall but are not continuous across junction (loadbearing case)</li> </ul>	<ul style="list-style-type: none"> <li>ceiling is framed with wood joists, wood I-joists, or wood trusses, with or without absorptive material<sup>(a)</sup> in cavities</li> <li>ceiling joists or trusses are oriented perpendicular to separating wall but are not continuous across junction (loadbearing case) or parallel to junction (non-loadbearing case)</li> <li>gypsum board ceiling is fastened directly to bottom of ceiling framing or on resilient metal channels<sup>(a)</sup></li> </ul>	<ul style="list-style-type: none"> <li>gypsum board on flanking walls ends or is cut at separating wall and is fastened directly to framing or on resilient metal channels<sup>(a)</sup></li> <li>flanking wall is framed with single row of wood studs, staggered studs on a single 38 mm <math>\times</math> 140 mm plate, or 2 rows of 38 mm <math>\times</math> 89 mm wood studs on separate 38 mm <math>\times</math> 89 mm plates, with or without absorptive material<sup>(a)</sup> in cavities</li> <li>flanking wall framing is structurally connected to separating wall and terminates where it butts against framing of separating wall or is continuous across junction</li> </ul>
	Example Showing Side View of Bottom and Top Junctions		Example Showing Plan View of Side Junctions

	 <p>ceiling</p> <p>W5 separating wall</p> <p>additional material layer over subfloor plus finished flooring with mass per area <math>&gt; 8 \text{ kg/m}^2</math></p> <p>EG01504A</p>	 <p>W5 separating wall</p> <p>flanking wall</p> <p>EG00064A</p>
	<p>Example Showing Side View of Bottom and Top Junctions</p>  <p>ceiling</p> <p>W12 separating wall</p> <p>additional material layer over subfloor plus finished flooring with mass per area <math>&gt; 8 \text{ kg/m}^2</math></p> <p>EG02037A</p>	<p>Example Showing Plan View of Side Junctions</p>  <p>W12 separating wall</p> <p>flanking wall</p> <p>EG02038A</p>
<p>W13, W14, W15</p>	<ul style="list-style-type: none"> <li>• for additional material layer and finished flooring, see Table 9.11.1.4.</li> <li>• subfloor on both sides of wall is plywood, OSB, waferboard (15.5 mm thick) or tongue and groove lumber (<math>\geq 17 \text{ mm}</math> thick)</li> <li>• wood joists, wood I-joists or wood trusses are oriented perpendicular or parallel to separating wall, with or without absorptive material<sup>(a)</sup> in cavities</li> <li>• joist framing at junction is supported on near leaf of separating wall</li> </ul>	<ul style="list-style-type: none"> <li>• flanking wall framing is fastened to adjacent leaf of separating wall</li> <li>• flanking wall is framed with single row of wood studs, staggered studs on a single <math>38 \text{ mm} \times 140 \text{ mm}</math> plate, or 2 rows of <math>38 \text{ mm} \times 89 \text{ mm}</math> wood studs on separate <math>38 \text{ mm} \times 89 \text{ mm}</math> plates,</li> </ul>

	<ul style="list-style-type: none"> <li>• floor is framed with wood joists, wood I-joists or wood trusses spaced <math>\geq 400</math> mm o.c., with or without absorptive material<sup>(2)</sup> in cavities</li> <li>• floor joists or trusses are oriented parallel to separating wall (non-loadbearing case) or perpendicular to separating wall but are not continuous across junction (loadbearing case)</li> <li>• near leaf of separating wall is supported on "designated" joist</li> </ul>	<ul style="list-style-type: none"> <li>• gypsum board ceiling panels end at wall framing and are fastened directly to bottom of ceiling framing or on resilient metal channels<sup>(3)</sup></li> </ul>	<ul style="list-style-type: none"> <li>with or without absorptive material<sup>(2)</sup> in cavities</li> <li>• gypsum board panels on flanking walls ends or is cut at framing of separating wall and is fastened on resilient metal channels<sup>(3)</sup> or directly to framing of flanking wall if that framing and any sheathing are not continuous across the junction</li> </ul>
	<p>Example Showing Side View of Bottom and Top Junctions</p> 		<p>Example Showing Plan View of Side Junctions</p> 
<p>S1 to S15</p>	<ul style="list-style-type: none"> <li>• F1 concrete floor assembly from Table 9.10.3.1.-B with mass per area not less than <math>300 \text{ kg/m}^2</math> (e.g. normal-weight concrete with average thickness of 130 mm)</li> <li>• with or without an additional material layer or finished flooring</li> </ul>	<ul style="list-style-type: none"> <li>• F1 concrete floor assembly from Table 9.10.3.1.-B with mass per area not less than <math>300 \text{ kg/m}^2</math> (e.g. normal-weight concrete with average thickness of 130 mm)</li> <li>• with or without gypsum board ceiling suspended below concrete floor</li> </ul>	<ul style="list-style-type: none"> <li>• flanking wall framing is structurally connected to separating wall and terminates where it butts against framing of separating wall or is continuous across junction</li> <li>• gypsum board on flanking walls ends or is cut at separating wall and is fastened directly to framing or on resilient metal channels<sup>(3)</sup></li> </ul>

		<ul style="list-style-type: none"> <li>flanking wall consists of steel framing (loadbearing or non-loadbearing steel studs) or concrete blocks with mass per area not less than 200 kg/m<sup>2</sup> (e.g. normal-weight hollow core concrete block units<sup>2</sup>) with a gypsum board lining supported on framing providing a cavity not less than 50 mm deep)</li> <li>with or without absorptive material<sup>2</sup> in cavities behind gypsum board of flanking walls</li> </ul>	
	<p>Example Showing Side View of Bottom and Top Junctions</p> 	<p>Example Showing Plan View of Side Junctions</p> 	
B1 to B10	<ul style="list-style-type: none"> <li>same options as stated above for walls S1 to S15</li> </ul>	<ul style="list-style-type: none"> <li>same options as stated above for walls S1 to S15</li> <li>junction at top of concrete block assembly is loadbearing or non-loadbearing resilient joint</li> </ul>	<ul style="list-style-type: none"> <li>same options as stated above for walls S1 to S15</li> </ul>
	<p>Example Showing Side View of Bottom and Top Junctions</p>	<p>Examples Showing Plan View of Side Junctions</p>	



**Notes to Table A-9.11.1.4.-A:**

- (1) See also Table A-9.11.1.4.-B.
- (2) Sound absorptive material is porous (closed-cell foam was not tested) and includes fibre processed from rock, slag, glass or cellulose fibre with a maximum density of 32 kg/m<sup>3</sup>. See Table Notes (5) and (8) of Table 9.10.3.1.-A and Table Note (5) of Table 9.10.3.1.-B for additional information.
- (3) Resilient metal channels are formed from steel having a maximum thickness of 0.46 mm (25 gauge) with slits or holes in the single “leg” between the faces fastened to the framing and to the gypsum board (see Figure A-9.10.3.1.-D). ASTM C754, “Standard Specification for Installation of Steel Framing Members to Receive Screw-Attached Gypsum Panel Products,” describes the installation of resilient metal channels.
- (4) Normal-weight concrete block units conforming to CSA A165.1, “Concrete block masonry units,” have aggregate with a density not less than 2 000 kg/m<sup>3</sup>; 190 mm hollow core units are 53% solid, providing a wall mass per area over 200 kg/m<sup>2</sup>; 140 mm hollow core units are 75% solid, providing a wall mass per area over 200 kg/m<sup>2</sup>.

Table A-9.11.1.4.-B presents options for improving the sound performance of separating wall systems beyond that achieved by implementing the options presented in Table A-9.11.1.4.-A. The suggested performance improvement options are listed in order of approximate acoustic priority and are interdependent, i.e., if options at the top of the list are not implemented, then options at the bottom of the list will have much lesser effect.

**Table A-9.11.1.4.-B**

**Options for the Construction of a Separating Wall System to Further Improve the Sound Insulation Performance Achieved with the Options in Table A-9.11.1.4.-A**

Type of Separating Wall Assembly with STC ≥ 50 from Table 9.10.3.1.-A	Performance Improvement Options for Junctions Between Separating Walls and Flanking Floor/Ceiling Assemblies
W4, W5, W6, W8, W9, W10, W11, W12	<ul style="list-style-type: none"> <li>• Increase mass per area of additional material layer and finished flooring over subfloor (e.g. concrete or gypsum concrete topping)</li> <li>• Choose separating wall assembly with higher STC rating</li> <li>• Orient floor and ceiling joists parallel to separating wall (non-loadbearing case)</li> </ul>



	<ul style="list-style-type: none"> <li>• Add resilient layer under additional material layer over subfloor or between additional material layer and finished flooring</li> <li>• Support gypsum board panels of ceiling on resilient metal channels<sup>(1)</sup></li> <li>• Support gypsum board panels of flanking walls on resilient metal channels<sup>(1)</sup></li> </ul>
W13, W14, W15	<ul style="list-style-type: none"> <li>• If seismic or other structural requirements permit, choose a fire block detail at floor/wall junction in accordance with Subsection 9.10.16. that does not provide a rigid connection between the two rows of framing of the separating wall (e.g. subfloor not continuous across junction and semi-rigid fibre insulation board filling the gap in accordance with Article 9.10.16.3.). In this case, an additional material layer would not be necessary. Also, choose separating wall assembly with higher STC rating (e.g. more absorptive material<sup>(2)</sup> in cavities and/or more gypsum board).</li> <li>• If having a rigid structural connection at the floor/wall junction (such as subfloor continuous across the junction) is required for seismic or other structural reasons, obtain a higher ASTC rating as follows: <ul style="list-style-type: none"> <li>• Increase combined mass per area of additional material layer over subfloor and finished flooring (e.g. concrete or gypsum concrete topping)</li> <li>• Choose separating wall assembly with higher STC rating (e.g. more absorptive material<sup>(2)</sup> and/or more gypsum board)</li> <li>• Support gypsum board panels of ceiling on resilient metal channels<sup>(1)</sup></li> <li>• Support gypsum board panels of flanking walls on resilient metal channels<sup>(1)</sup></li> <li>• Add resilient layer under additional material layer over subfloor or between additional material layer and finished flooring</li> </ul> </li> </ul>
S1 to S15	<ul style="list-style-type: none"> <li>• Choose separating wall assembly with higher STC rating</li> <li>• Increase thickness of concrete floor slab and/or add material layer and finished flooring over subfloor</li> <li>• Add gypsum board ceiling on framing supported under the floor above, with cavity not less than 100 mm deep</li> <li>• Add resilient layer under additional material layer over subfloor or between additional material layer and finished flooring</li> <li>• Support gypsum board panels of flanking walls on resilient metal channels<sup>(1)</sup> if steel studs are loadbearing type</li> </ul>
B1 to B10	<ul style="list-style-type: none"> <li>• Choose separating wall assembly with higher STC rating</li> <li>• Add gypsum board ceiling supported below concrete floor with cavity not less than 100 mm deep and sound absorptive material<sup>(2)</sup> in cavity</li> <li>• Increase thickness of concrete floor slab and/or add material layer and finished flooring over subfloor</li> <li>• Add resilient layer under additional material layer over subfloor or between additional material layer and finished flooring and increase mass per area of additional material layer and finished flooring (e.g. floating concrete or gypsum concrete topping)</li> <li>• Support gypsum board panels of flanking walls on resilient metal channels<sup>(1)</sup> if steel studs are loadbearing type</li> </ul>

**Notes to Table A-9.11.1.4.-B:**

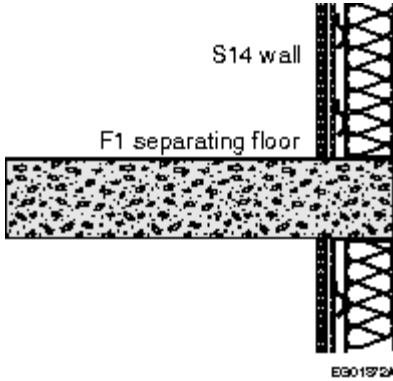
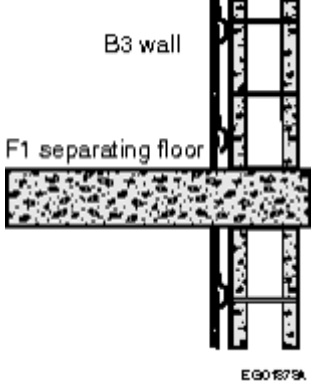
<sup>(1)</sup> Resilient metal channels are formed from steel having a maximum thickness of 0.46 mm (25 gauge) with slits or holes in the single “leg” between the faces fastened to the framing and to the gypsum board (see Figure A-9.10.3.1.-D). ASTM C754, “Standard Specification for Installation of Steel Framing Members to Receive Screw-Attached Gypsum Panel Products,” describes the installation of resilient metal channels.

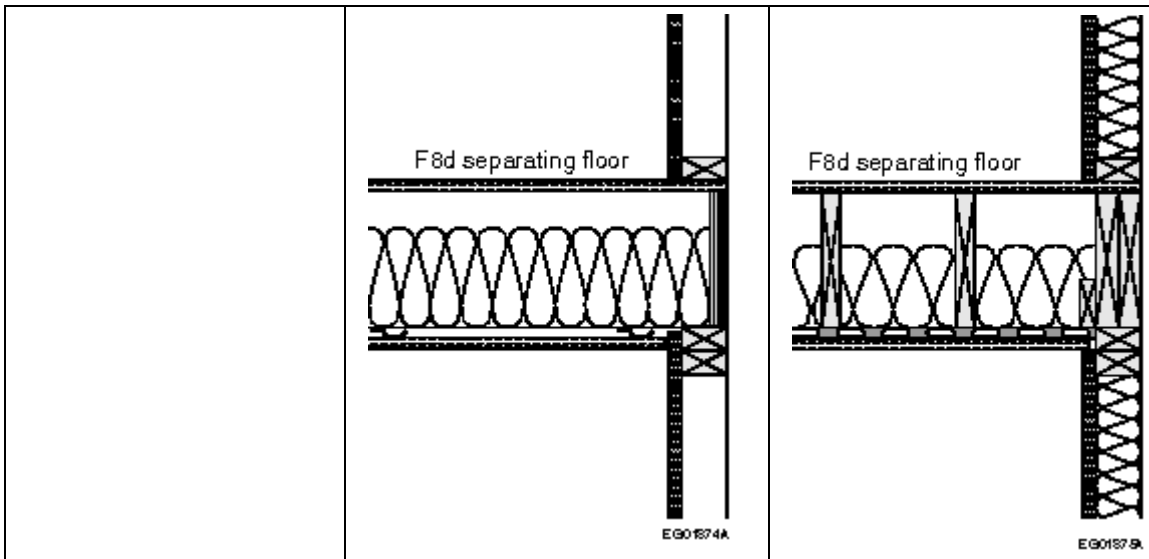
<sup>(2)</sup> Sound absorptive material is porous (closed-cell foam was not tested) and includes fibre processed from rock, slag, glass or cellulose fibre with a maximum density of 32 kg/m<sup>3</sup>. See Table Notes (5) and (8) of Table 9.10.3.1.-A and Table Note (5) of Table 9.10.3.1.-B for additional information.

Table A-9.11.1.4.-C presents compliance options for the construction of separating floor/ceiling assemblies with flanking wall assemblies in vertically adjoining spaces.

**Table A-9.11.1.4.-C**

**Options for the Design and Construction of Junctions and Flanking Surfaces Between Separating Floor/Ceiling Assemblies in Vertically Adjoining Spaces for Compliance with Clause 9.11.1.1.(1)(b)**

Type of Separating Floor/Ceiling Assembly with $STC \geq 50$ from Table 9.10.3.1.-B	Options for Design and Construction of Junctions and Flanking Surfaces <sup>(1)</sup> to Address Vertical Sound Transmission Paths	
F1 (with or without gypsum board ceiling)	Junctions with Flanking Steel-Framed Walls	Junctions with Flanking Concrete Walls
	<ul style="list-style-type: none"> <li>• floor ends at flanking wall assembly (T-junction) or extends beyond it (cross-junction)</li> <li>• steel framing of flanking walls is loadbearing or non-loadbearing, with a single row of steel studs, staggered studs, or 2 rows of studs, with studs spaced not less than 400 mm o.c., with or without absorptive material<sup>(2)</sup> in cavities</li> <li>• flanking wall structure is fastened to separating concrete floor but is not continuous across junction</li> <li>• gypsum board on flanking walls is not continuous across junction and is fastened directly to wall framing or on resilient metal channels<sup>(3)</sup></li> </ul>	<ul style="list-style-type: none"> <li>• floor ends at flanking wall assembly (T-junction) or extends beyond it (cross-junction)</li> <li>• one wythe of concrete blocks with mass per area not less than 200 kg/m<sup>2</sup> (e.g. normal-weight hollow core concrete block units<sup>(4)</sup>)</li> <li>• loadbearing (solid) or non-loadbearing (resilient) junction between top of flanking concrete block wall and floor structure</li> <li>• gypsum board lining is supported on wood or steel framing providing a cavity not less than 50 mm deep, with or without absorptive material<sup>(2)</sup> in cavities</li> <li>• gypsum board on flanking walls is not continuous across junction and is fastened directly to wall framing or on resilient metal channels<sup>(3)</sup></li> </ul>
Examples Showing Side View of Junctions		
	 <p>The diagram shows a side view of a junction between an S14 wall and an F1 separating floor. The floor is a thick, textured concrete slab. The wall is a steel-framed wall with vertical studs and horizontal plates. The floor ends at the wall assembly (T-junction). The diagram is labeled 'S14 wall' and 'F1 separating floor' and has the code 'EG01872A' at the bottom.</p>	 <p>The diagram shows a side view of a junction between a B3 wall and an F1 separating floor. The floor is a thick, textured concrete slab. The wall is a concrete block wall with vertical studs and horizontal plates. The floor ends at the wall assembly (T-junction). The diagram is labeled 'B3 wall' and 'F1 separating floor' and has the code 'EG01873A' at the bottom.</p>
F8 to F38	Junctions with Flanking Loadbearing or Non-Loadbearing Walls	
	<ul style="list-style-type: none"> <li>• wood studs of flanking wall are 38 mm × 89 mm or 38 mm × 140 mm and spaced 400 mm or 600 mm o.c.</li> <li>• flanking wall framing consists of single row of wood studs, staggered studs on a single 38 mm × 140 mm plate, or 2 rows of 38 mm × 89 mm wood studs on separate 38 mm × 89 mm plates, with or without absorptive material<sup>(2)</sup> in wall cavities</li> <li>• gypsum board on flanking walls ends or is cut near floor framing and is fastened directly to wall framing or supported on resilient metal channels<sup>(3)</sup></li> </ul>	
	Example Showing Side View of Junctions in Flanking Loadbearing Wall	Example Showing Side View of Junctions in Flanking Non-Loadbearing Wall



**Notes to Table A-9.11.1.4.-C:**

<sup>(1)</sup> See also Table A-9.11.1.4.-D.

<sup>(2)</sup> Sound absorptive material is porous (closed-cell foam was not tested) and includes fibre processed from rock, slag, glass or cellulose fibre with a maximum density of 32 kg/m<sup>3</sup>. See Table Notes (5) and (8) of Table 9.10.3.1.-A and Table Note (5) of Table 9.10.3.1.-B for additional information.

<sup>(3)</sup> Resilient metal channels are formed from steel having a maximum thickness of 0.46 mm (25 gauge) with slits or holes in the single “leg” between the faces fastened to the framing and to the gypsum board (see Figure A-9.10.3.1.-D). ASTM C754, “Standard Specification for Installation of Steel Framing Members to Receive Screw-Attached Gypsum Panel Products,” describes the installation of resilient metal channels.

<sup>(4)</sup> Normal-weight concrete block units conforming to CSA A165.1, “Concrete block masonry units,” have aggregate with a density not less than 2 000 kg/m<sup>3</sup>; 190 mm hollow core units are 53% solid, providing a wall mass per area over 200 kg/m<sup>2</sup>; 140 mm hollow core units are 75% solid, providing a wall mass per area over 200 kg/m<sup>2</sup>.

Table A-9.11.1.4.-D presents options for improving the sound performance of separating floor/ceiling assemblies beyond that achieved by implementing the options presented in Table A-9.11.1.4.-C. The suggested performance improvement options are listed in order of approximate acoustic priority and are interdependent, i.e., if options at the top of the list are not implemented, then options at the bottom of the list will have much lesser effect.

Table A-9.11.1.4.-D

Options for the Construction of a Separating Floor System<sup>3</sup> to Further Improve the Sound Insulation Performance Achieved with the Options in Table A-9.11.1.4.-C

Type of Separating Floor Assembly with STC ≥ 50 from Table 9.10.3.1.-B	Performance Improvement Options for Junctions Between Separating Floors and Flanking Wall Assemblies
F1 (with or without gypsum board ceiling)	<ul style="list-style-type: none"> <li>• Add heavier additional material layer over subfloor and/or resilient layer under additional material layer or between additional material layer and finished flooring</li> <li>• Add gypsum board ceiling supported at least 100 mm below concrete floor with minimal structural connection (e.g. ceiling framing supported resiliently) and sound absorptive material<sup>(1)</sup> in cavity</li> <li>• Support gypsum board of flanking walls of lower room on resilient metal channels<sup>(2)</sup> (if framed with loadbearing studs)</li> </ul>

F8 to F38	<ul style="list-style-type: none"> <li>• Add heavier additional material layer over subfloor and/or resilient layer under additional material layer or between additional material layer and finished flooring</li> <li>• Add more/heavier gypsum board to ceiling and increase spacing of resilient metal channels<sup>(2)</sup> to 600 mm o.c.</li> <li>• Support gypsum board of flanking loadbearing walls of lower room on resilient metal channels<sup>(2)</sup></li> <li>• Support gypsum board on flanking non-loadbearing walls of lower room on resilient metal channels<sup>(2)</sup></li> </ul>
-----------	---

**Notes to Table A-9.11.1.4.-D:**

<sup>(1)</sup> Sound absorptive material is porous (closed-cell foam was not tested) and includes fibre processed from rock, slag, glass or cellulose fibre with a maximum density of 32 kg/m<sup>3</sup>. See Table Notes (5) and (8) of Table 9.10.3.1.-A and Table Note (5) of Table 9.10.3.1.-B for additional information.

<sup>(2)</sup> Resilient metal channels are formed from steel having a maximum thickness of 0.46 mm (25 gauge) with slits or holes in the single “leg” between the faces fastened to the framing and to the gypsum board (see Figure A-9.10.3.1.-D). ASTM C754, “Standard Specification for Installation of Steel Framing Members to Receive Screw-Attached Gypsum Panel Products,” describes the installation of resilient metal channels.

**A-Table 9.11.1.4. Floor Treatments.** The sound insulation performance of lightweight framed floors can be improved by adding floor treatments, i.e., additional layers of material over the subfloor (e.g. concrete topping, OSB or plywood) and finished flooring or coverings (e.g., carpet, engineered wood). Table A-Table 9.11.1.4. presents the mass per area values based on thickness and density of a number of generic floor treatment materials (the values for proprietary products may be different; consult the manufacturer's current data sheets for their products' values).

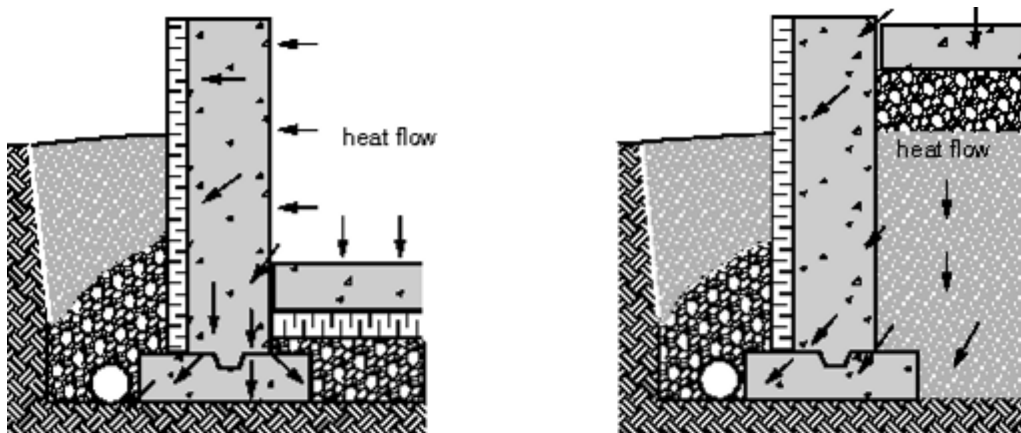
Table A-Table 9.11.1.4.

Mass per Area of Floor Treatment Materials

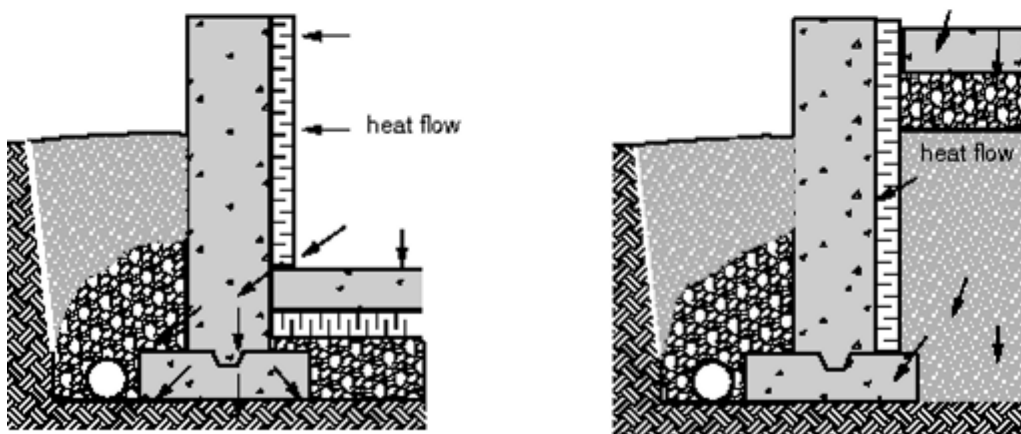
Floor Treatment Material	Thickness, mm	Density, kg/m <sup>3</sup>	Mass per Area, kg/m <sup>2</sup>
<b>Materials Typically Having a Mass per Area Less Than 8 kg/m<sup>2</sup></b>			
Medium-density fibreboard (MDF)	2.9–6.1	790–810	2.3–5.0
Plywood – generic softwood	12.5–13.3	450–500	5.6–6.6
	15.5–16.3		7.0–8.1
Ceramic tile	8.4	700–1 000	5.9–8.4
<b>Materials Typically Having a Mass per Area Greater Than 8 kg/m<sup>2</sup> but Less Than 16 kg/m<sup>2</sup></b>			
Particleboard	11.3–19.2	710–755	8.1–14.5
Medium-density fibreboard (MDF)	13.9–21.1	640–755	8.9–15.9
Oriented strandboard (OSB)	14.3–15.8	600–680	8.6–10.7
	17.3–18.8		10.4–12.8
Plywood – generic softwood	25.5	450–500	11.5–13.1
<b>Materials Typically Having a Mass per Area Greater Than 16 kg/m<sup>2</sup> but Less Than 32 kg/m<sup>2</sup></b>			
Medium-density fibreboard (MDF)	25.0–32.1	640–740	16.0–23.7
<b>Materials Typically Having a Mass per Area Greater Than 32 kg/m<sup>2</sup></b>			
Concrete	40.0–50.0	2 015–2 380	80.6–119.0
Gypsum concrete	25.0	1 840–1 870	46.1–46.7

A-Table 9.12.2.2. Minimum Depths of Foundations. The requirements for clay soils or soils not clearly defined are intended to apply to those soils that are subject to significant volume changes with changes in moisture content.

**A-9.12.2.2.(2) Depth and Insulation of Foundations.**



Insulated in a manner that will allow heat flow to the soil beneath the footings



Insulated in a manner that will reduce heat flow to the soil beneath the footings

EG008-1D

**Figure A-9.12.2.2.(2)**  
**Foundation insulation and heat flow to the soil beneath the footings**

**A-9.12.3.3.(1) Deleterious Material in Backfill.** The deleterious debris referred to in this provision includes, but is not limited to:

- organic material and other material subject to decomposition and compaction, which could have an adverse effect on grading around the building,
- materials that will off-gas and have the potential to pose a health hazard, and
- materials that are incompatible with materials used in the foundations, footings, drainage materials or components, or other elements of the building whose required performance would be adversely affected.

**A-9.13.2.5. Protection of Interior Finishes against Moisture.** Excess water from cast-in-place concrete and ground moisture tends to migrate toward interior spaces, particularly in the spring and summer. Where moisture-susceptible materials, such as finishes or wood members, are in contact with the foundation wall, the moisture needs to be controlled by installing a moisture

barrier on the interior surface of the foundation wall that extends from the underside of the interior finish up the face of the wall to a point just above the level of the ground outside.

The reason the moisture barrier on the interior surface of the foundation wall must be stopped near ground level is to allow any moisture that finds its way into the finished wall cavity from the interior space (through leaks in the air or vapour barrier) to diffuse to the exterior. If the vapour permeance of dampproofing membranes or coatings exceeds  $170 \text{ ng}/(\text{Pa}\times\text{s}\times\text{m}^2)$ , such moisture barriers may be carried full height; if their vapour permeance is less than that, this moisture risks being trapped on the interior surface of the moisture barriers. The permeance limit corresponds to the lower limit for breather-type membranes, such as asphalt-impregnated sheathing paper.

Some insulation products can also be used to protect interior finishes from the effects of moisture. They have shown acceptable performance when applied over the entire foundation wall because, in this case, they also provide vapour barrier and moisture barrier functions and possibly also the air barrier function. Where a single product provides all these functions, there is no risk of trapping moisture between two functional barriers with low water vapour permeance.

**A-9.13.4. Soil Gas Control.** Outdoor air entering a dwelling through above-grade leaks in the building envelope normally improves the indoor air quality in the dwelling by reducing the concentrations of pollutants and water vapour. It is only undesirable because it cannot be controlled. On the other hand, air entering a dwelling through below-grade leaks in the envelope may increase the water vapour content of the indoor air and may also bring in a number of pollutants picked up from the soil. This mixture of air, water vapour and pollutants is sometimes referred to as “soil gas.” One pollutant often found in soil gas is radon.

Sentence 9.13.4.2.(1), which requires the installation of an air barrier system, addresses the protection from all soil gases, while the remainder of Article 9.13.4.2. along with Article 9.13.4.3., which require the provision of the means to depressurize the space between the air barrier and the ground, specifically address the capability to mitigate high radon concentrations in the future, should this become necessary.

Radon is a colourless, odourless, radioactive gas that occurs naturally as a result of the decay of radium. It is found to varying degrees as a component of soil gas in all regions of Canada and is known to enter dwelling units by infiltration into basements and crawl spaces. The presence of radon in sufficient quantity can lead to an increased risk of lung cancer.

The potential for high levels of radon infiltration is very difficult to evaluate prior to construction and thus a radon problem may only become apparent once the building is completed and occupied. Therefore various sections of Part 9 require the application of certain radon exclusion measures in all dwellings. These measures are

- low in cost,
- difficult to retrofit, and
- desirable for other benefits they provide.

The principal method of resisting the ingress of all soil gases, a resistance which is required for all buildings (see Sentence 9.13.4.2.(1)), is to seal the interface between the soil and the occupied space, so far as is reasonably practicable. Sections 9.18. and 9.25. contain requirements for air and soil gas barriers in assemblies in contact with ground, including those in crawl spaces. Providing control joints to reduce cracking of foundation walls and airtight covers for sump pits (see Section 9.14.) are other measures that can help achieve this objective. The requirements provided in Subsection 9.25.3. are explained in Notes A-9.25.3.4. and 9.25.3.6. and A-9.25.3.6.(2) and (3).

The principal method of excluding radon is to ensure that the pressure difference across the ground/space interface is positive (i.e., towards the outside) so that the inward flow of radon through any remaining leaks will be minimized. The requirements provided in Article 9.13.4.3. are explained in Note A-9.13.4.3.

**A-9.13.4.2.(3) Exception for Buildings Occupied for a Few Hours a Day.** The criterion used by Health Canada to establish the guideline for acceptable radon concentration is the time that occupants spend inside buildings. Health Canada recommends installing a means for the future removal of radon in buildings that are occupied by persons for more than 4 hours per day. Sentence 9.13.4.2.(3) may therefore not apply to buildings or portions of buildings that are intended to be occupied for less than 4 hours a day. Addressing a radon problem in such buildings in the future, should that become necessary, can also be achieved by providing a means for increased ventilation at times when these buildings are occupied.

#### **A-9.13.4.3. Providing Performance Criteria for the Depressurization of the Space Between the Air Barrier System and the Ground**

Article 9.13.4.3. contains two sets of requirements: Sentence (2) describes the criteria for subfloor depressurization systems using performance-oriented language, while Sentence (3) describes one particular acceptable solution using more prescriptive language.

In some cases, subfloor depressurization requires a solution other than the one described in Sentence (3), for example, where compactable fill is installed under slab-on-grade construction.

#### **Completion of a Subfloor Depressurization System**

The completion of a subfloor depressurization system may be necessary to reduce the radon concentration to a level below the guideline specified by Health Canada.

Further information on protection from radon ingress can be found in the following Health Canada publications:

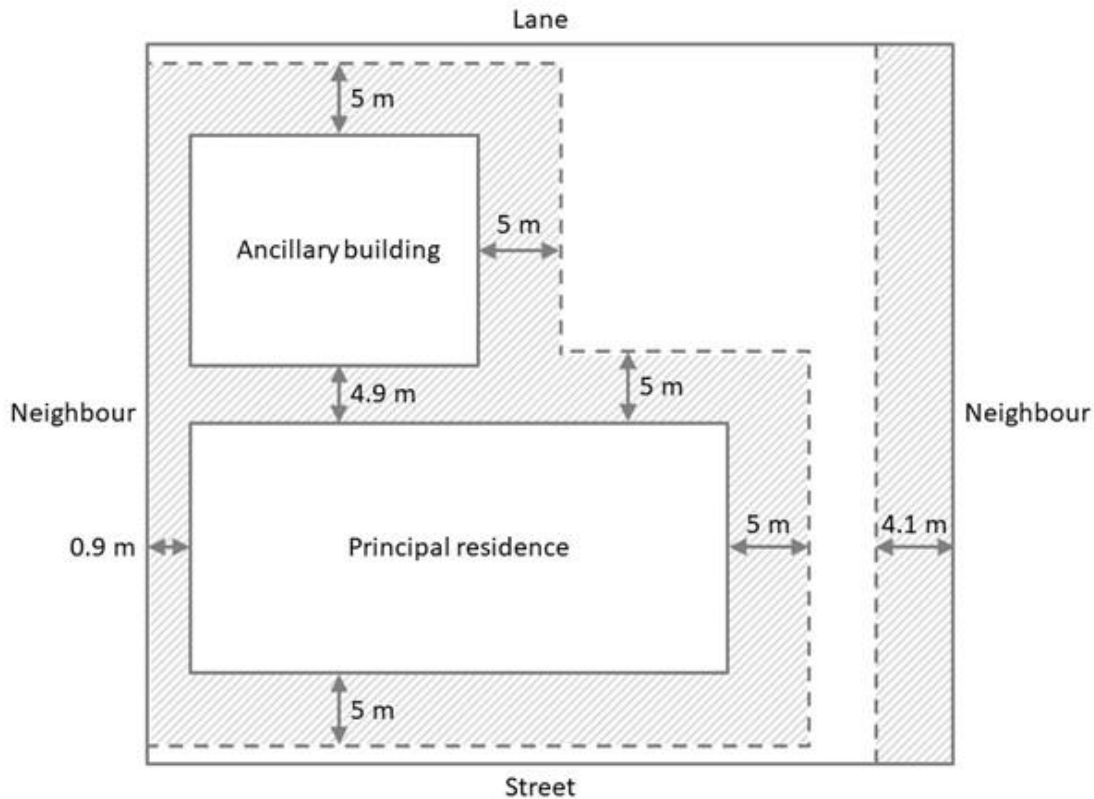
- “Radon: A Guide for Canadian Homeowners” (CMHC/HC), and
- “Guide for Radon Measurements in Residential Dwellings (Homes).”

**A-9.13.4.3.(2)(b) and (3)(b) Effective Depressurization.** To allow effective depressurization of the space between the air barrier and the ground, the extraction opening (the pipe) should not be blocked and should be arranged such that air can be extracted from the entire space between the air barrier and the ground. This will ensure that the extraction system can maintain negative pressure underneath the entire floor (or in heated crawl spaces underneath the air barrier). The arrangement and location of the extraction system inlet(s) may have design implications where the footing layout separates part of the space underneath the floor. If an area is segregated by a footing (for example), a through-footing pipe can join the area so that a single suction point can depressurize both areas. However, for large buildings, it may be preferable to have multiple suction points.

**A-9.14.2.1.(2)(a) Insulation Applied to the Exterior of Foundation Walls.** In addition to the prevention of heat loss, some types of mineral fibre insulation, such as rigid glass fibre, are installed on the exterior of basement walls for the purpose of moisture control. This is sometimes used instead of crushed rock as a drainage layer between the basement wall and the surrounding soil in order to facilitate the drainage of soil moisture. Water drained by this drainage layer must be carried away from the foundation by the footing drains or the granular drainage layer in order to prevent it from developing hydro-static pressure against the wall. Provision must be made to permit the drainage of this water either by extending the insulation or crushed rock to the drain or by the installation of granular material connecting the two. The installation of such drainage

layer does not eliminate the need for normal waterproofing or dampproofing of walls as specified in Section 9.13.

**A-9.14.5.3.(2) Siting Requirements for On-Site Infiltration Systems.** Figure A-9.14.5.3.(2) shows minimum setbacks for on-site infiltration systems from buildings and neighbouring properties. Also shown is the 0.9 m firefighters' access to an ancillary residential building (see Sentence 9.10.20.3.(3)) and the 4.9 m separation between a laneway home and the principal residence (see Zoning and Development By-law section 11.3.8). Setbacks from the street, lane and utilities infrastructure are at the discretion of the City Engineer and other authorities. (This figure is not a comprehensive summary of all potentially applicable setback regulations.)



**Figure A-9.14.5.3.(2) Minimum setbacks for on-site infiltration systems from buildings and neighbouring properties.** Not to scale.

The intent of this requirement is to limit harm to persons and damage to buildings from excessive moisture loading on foundation walls, basement floors and the soil immediately beneath footings.

The minimum setbacks apply to any system to which water is directed for infiltration, such as infiltration trenches, swales and basins; rain gardens; rock and soak-away pits; and proprietary modular units designed for subsurface infiltration. The setbacks do not apply to landscaping. Certain ancillary buildings need not conform to the drainage requirements of Section 9.14 when Sentence 9.35.3.3.(1) applies.

An overflow is required for infiltration systems.

Professionals should be consulted when infiltration constraints exist such as contaminated soils, unstable soils, peat, shallow bedrock or cemented layers in soils, steep slopes, a high water table, a land use with a groundwater pollution risk, a nearby drinking water well, or an area of



protected habitat. For drainage requirements near retaining walls, EGBC's "Professional Practice Guidelines – Retaining Wall Design" should be consulted.

**A-9.15.1.1. Application of Footing and Foundation Requirements to Decks and Similar Constructions.** Because decks, balconies, verandas and similar platforms support occupancies, they are, by definition, considered as buildings or parts of buildings. Consequently, the requirements in Section 9.15. regarding footings and foundations apply to these constructions.

**A-9.15.1.1.(1)(c) and 9.20.1.1.(1)(b) Flat Insulating Concrete Form Walls.** Insulating concrete form (ICF) walls are concrete walls that are cast into manufactured insulating forms, which remain in place after the concrete has cured.

Flat wall insulating concrete forms do not fall within the scope of CSA S269.1, "Falsework and formwork," which addresses temporary falsework for concrete structures.

Flat ICF walls are solid ICF walls where the concrete is of uniform thickness over the height and width of the wall.

**A-9.15.2.4.(1) Preserved Wood Foundations – Design Assumptions.** Tabular data and figures in CSA S406, "Specification of permanent wood foundations for housing and small buildings," are based upon the general principles provided in CSA O86, "Engineering design in wood," with the following assumptions:

- soil bearing capacity: 75 kPa or more,
- clear spans for floors: 5 000 mm or less,
- floor loadings: 1.9 kPa for first floor and suspended floor, and 1.4 kPa for second storey floor,
- foundation wall heights: 2 400 mm for slab floor, 3 000 mm for suspended wood floor,
- top of granular layer to top of suspended wood floor: 600 mm,
- lateral load from soil pressure: equivalent to fluid pressure of 4.7 kPa per metre of depth,
- ground snow load: 3 kPa,
- basic snow load coefficient: 0.6,
- roof loads are carried to the exterior wall,
- dead loads:

roof	0.50 kPa
floor	0.47 kPa
wall (with siding)	0.32 kPa
wall (with masonry veneer)	1.94 kPa
foundation wall	0.27 kPa
partitions	0.20 kPa

**A-9.15.3.4.(2) Footing Sizes.** The footing sizes in Table 9.15.3.4. are based on typical construction consisting of a roof, not more than 3 storeys, and centre bearing walls or beams. For this reason, Clause 9.15.3.3.(1)(b) stipulates a maximum supported joist span of 4.9 m.

It has become common to use flat wood trusses or wood I-joists to span greater distances in floors of small buildings. Where these spans exceed 4.9 m, minimum footing sizes may be based on the following method:

- (a) Determine for each storey the span of joists that will be supported on a given footing. Sum these lengths (sum<sub>1</sub>).
- (b) Determine the product of the number of storeys times 4.9 m (sum<sub>2</sub>).
- (c) Determine the ratio of sum<sub>1</sub> to sum<sub>2</sub>.
- (d) Multiply this ratio by the minimum footing sizes in Table 9.15.3.4. to get the required minimum footing size.

Example: A 2-storey house is built using wood I-joists spanning 6 m.

- (a)  $\text{sum}_1 = 6 + 6 = 12 \text{ m}$
- (b)  $\text{sum}_2 = 4.9 \times 2 = 9.8 \text{ m}$
- (c)  $\text{ratio } \text{sum}_1/\text{sum}_2 = 12/9.8 = 1.22$
- (d) required minimum footing size =  $1.22 \times 350 \text{ mm}$  (minimum footing size provided in Table 9.15.3.4.) = 427 mm.

**A-Table 9.15.4.2.-A Flat Insulating Concrete Form Walls as Foundation Walls.** Article 9.15.4.2. allows insulating concrete forms (ICFs) to be used to form both laterally supported and laterally unsupported flat, plain (unreinforced) concrete foundation walls intended to support wood-frame walls, floors and roofs under the conditions stipulated in Table 9.15.4.2.-A. Where the limits stated in the Table are exceeded, or where the ICF foundation wall is intended to support one or two storeys of concrete walls formed with flat wall ICFs above ground, Article 9.15.4.5. applies.

**A-9.16.2.1.(1) Drainage Layer Beneath Floors-on-Ground.** A drainage layer required by Sentence 9.16.2.1.(1) shall also be gas-permeable and conform to Article 9.13.4.3. in buildings to which that Article applies.

**A-9.17.2.2.(2) Lateral Support of Columns.** Because the NBC does not provide prescriptive criteria to describe the minimum required lateral support, constructions are limited to those that have demonstrated effective performance over time and those that are designed according to Part 4. Verandas on early 20th century homes provide one example of constructions whose floor and roof are typically tied to the rest of the building to provide effective lateral support. Large decks set on tall columns, however, are likely to require additional lateral support even where they are connected to the building on one side.

**A-9.17.3.4. Design of Steel Columns.** The permitted live floor loads of 2.4 kPa and the spans described for steel beams, wood beams and floor joists are such that the load on columns could exceed 36 kN, the maximum allowable load on columns prescribed in CAN/CGSB-7.2, "Adjustable Steel Columns." In the context of Part 9, loads on columns are calculated from the supported area times the live load per unit area, using the supported length of joists and beams. The supported length is half of the joist spans on each side of the beam and half the beam span on each side of the column.

Dead load is not included based on the assumption that the maximum live load will not be applied over the whole floor. Designs according to Part 4 must consider all applied loads.

**A-9.18.7.1.(4) Protection of Ground Cover in Warm Air Plenums.** The purpose of the requirement is to protect combustible ground cover from smouldering cigarette butts that may

drop through air registers. The protective material should extend beyond the opening of the register and have up-turned edges, as a butt may be deflected sideways as it falls.

**A-9.19.1.1.(1) Venting of Attic or Roof Spaces.** Controlling the flow of moisture by air leakage and vapour diffusion into attic or roof spaces is necessary to limit moisture-induced deterioration. Given that imperfections normally exist in the vapour barriers and air barrier systems, recent research indicates that venting of attic or roof spaces is generally still required. The exception provided in Article 9.19.1.1. recognizes that some specialized ceiling-roof assemblies, such as those used in some factory-built buildings, have, over time, demonstrated that their construction is sufficiently tight to prevent excessive moisture accumulation. In these cases, ventilation would not be required.

Further, the use of spray-in-place foam (SPF) insulation may also be considered sufficiently tight to prevent excessive moisture accumulation provided that acceptable procedures, material requirements, location restraints, installation requirements and inspection documentation has been met. The exception for SPF is for a 'typical' indoor environment. The exception shall not be used for high humidity interior environments such as ceilings above indoor hot tubs, etc. Caution should also be given to the use of SPF in ceilings above kitchens and bathrooms, where the incorrect use of venting equipment could create high humidity conditions for extended periods of time. For installations where the ceiling-roof assembly has a slope of less than 2-in-12, additional attention should be given to the roof membrane. More frequent monitoring and maintenance is recommended. Where possible, it is recommended that the vapour be allowed to transfer to the top side of the assembly, in other words, consideration should be given for cross ventilation above the roof sheathing.

**A-9.19.2.1.(1) Access to Attic or Roof Space.** The term "open space" refers to the space between the insulation and the roof sheathing. Sentence 9.19.2.1.(1) requires the installation of an access hatch where the open space in the attic or roof is large enough to allow visual inspection. Although the dimensions of an uninsulated attic or roof space may meet the size that triggers the requirement for an access hatch to be installed, most of that space will actually be filled with insulation and may therefore not be easily inspected, particularly in smaller buildings or under low-sloped roofs. See also Article ~~9.36.2.6~~ 10.2.2.6.

**A-9.20.1.2. Seismic Information.** Information on spectral acceleration values for various locations can be found in Appendix C.

A-9.20.5.1.(1) Masonry Support. Masonry veneer must be supported on a stable structure in order to avoid cracking of the masonry due to differential movement relative to parts of the support. Wood framing is not normally used as a support for the weight of masonry veneer because of its shrinkage characteristics. Where the weight of masonry veneer is supported on a wood structure, as is the case for the preserved wood foundations referred to in Sentence 9.20.5.1.(1) for example, measures must be taken to ensure that any differential movement that may be harmful to the performance of masonry is minimized or accommodated. The general principle stated in Article 9.4.1.1., however, makes it possible to support the weight of masonry veneer on wood framing, provided that engineering design principles prescribed in Part 4 are followed to ensure that the rigidity of the support is compatible with the stiffness of the masonry being supported and that differential movements between the support and masonry are accommodated.

**A-9.20.8.5.(1) Projection of Masonry Beyond Supporting Members.**

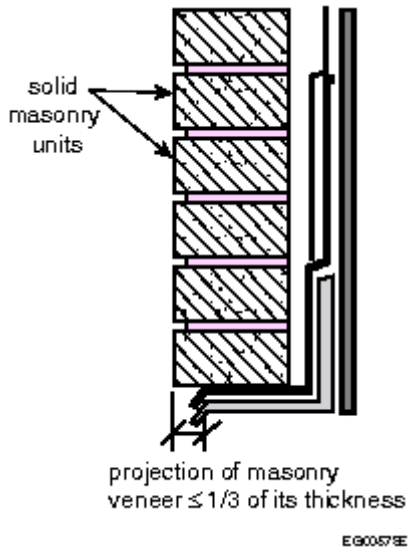


Figure A-9.20.8.5.(1)

**Maximum projection of masonry veneer beyond its support**

A-9.20.12.2.(2) Corbelling of Masonry Foundation Walls.

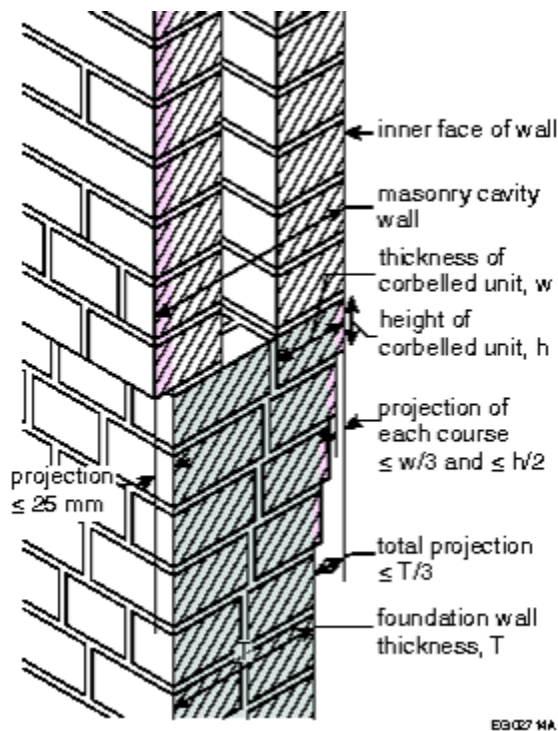


Figure A-9.20.12.2.(2)

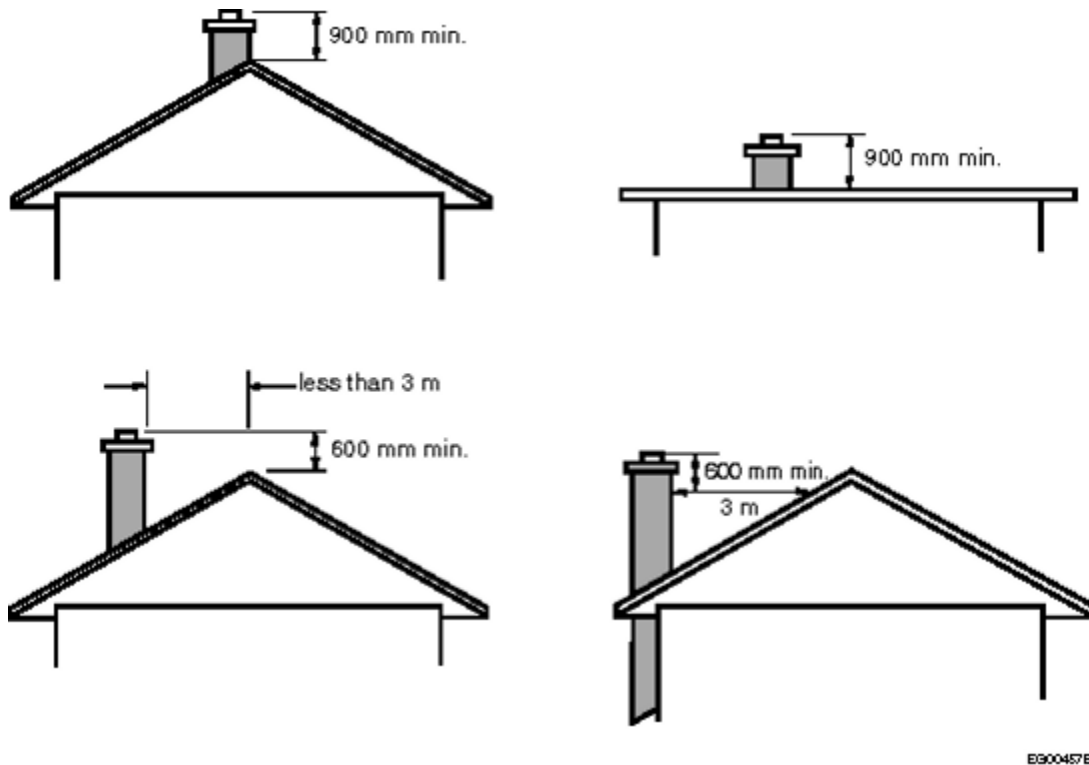
**Maximum corbel dimensions**

A-9.20.13.9.(3) **Dampproofing of Masonry Walls.** The reason for installing a sheathing membrane behind masonry walls is to prevent rainwater from reaching the interior finish if it should leak past the masonry. The sheathing membrane intercepts the rainwater and leads it to

the bottom of the wall where the flashing directs it to the exterior via weep holes. If the insulation is a type that effectively resists the penetration of water, and is installed so that water will not collect behind it, then there is no need for a sheathing membrane. If water that runs down between the masonry and the insulation is able to leak out at the joints in the insulation, such insulation will not act as a substitute for a sheathing membrane. If water cannot leak through the joints in the insulation but collects in cavities between the masonry and insulation, subsequent freezing could damage the wall. Where a sheathing membrane is not used, the adhesive or mortar should therefore be applied to form a continuous bond between the masonry and the insulation. If this is not practicable because of an irregular masonry surface, then a sheathing membrane is necessary.

**A-9.21.3.6.(2) Metal Chimney Liners.** Under the provisions of Article 1.2.1.1. of Division A, masonry chimneys with metal liners may be permitted to serve solid-fuel-burning appliances if tests show that such liners will provide an equivalent level of safety.

**A-9.21.4.4.(1) Location of Chimney Top.**



**Figure A-9.21.4.4.(1)**

**Vertical and horizontal distances from chimney top to roof**

**A-9.21.4.5.(2) Lateral Support for Chimneys.** Where a chimney is fastened to the house framing with metal anchors, in accordance with CAN/CSA-A370, "Connectors for masonry," it is considered to have adequate lateral support. The portion of the chimney stack above the roof is considered as free standing and may require additional lateral support.

**A-9.21.5.1.(1) Clearance from Combustible Materials.** For purposes of this Sentence, an exterior chimney can be considered to be one which has at least one surface exposed to the outside atmosphere or unheated space over the majority of its height. All other chimneys should be considered to be interior.

**A-9.23.1.1. Constructions Other than Light Wood-Frame Constructions.** The prescriptive requirements in Section 9.23. apply only to standard light wood-frame construction. Other constructions, such as post, beam and plank construction, plank frame wall construction, and log construction must be designed in accordance with Part 4.

**A-9.23.1.1.(1) Application of Section 9.23.** In previous editions of the Code, Sentence 9.23.1.1.(1) referred to “conventional” wood-frame construction. Over time, conventions have changed and the application of Part 9 has expanded.

The prescriptive requirements provided in Section 9.23. still focus on lumber beams, joists, studs and rafters as the main structural elements of “wood-frame construction.” The requirements recognize—and have recognized for some time—that walls and floors may be supported by components made of material other than lumber; for example, by foundations described in Section 9.15. or by steel beams described in Article 9.23.4.3. These constructions still fall within the general category of wood-frame construction.

With more recent innovations, alternative structural components are being incorporated into wood-frame buildings. Wood I-joists, for example, are very common. Where these components are used in lieu of lumber, the requirements in Section 9.23. that specifically apply to lumber joists do not apply to these components: for example, limits on spans and acceptable locations for notches and holes. However, requirements regarding the fastening of floor sheathing to floor joists still apply, and the use of wood I-joists does not affect the requirements for wall or roof framing.

Similarly, if steel floor joists are used in lieu of lumber joists, the requirements regarding wall or roof framing are not affected.

Conversely, Sentence 9.23.1.1.(1) precludes the installation of precast concrete floors on wood-frame walls since these are not “generally comprised of ... small repetitive structural members ... spaced not more than 600 mm o.c.”

Thus, the reference to “engineered components” in Sentence 9.23.1.1.(1) is intended to indicate that, where an engineered product is used in lieu of lumber for one part of the building, this does not preclude the application of the remainder of Section 9.23. to the structure, provided the limits to application with respect to cladding, sheathing or bracing, spacing of framing members, supported loads and maximum spans are respected.

**A-9.23.2.4.(3) Dry Interior Environment for Interior Construction.** Interior construction, which includes sill plates, that is not in contact with the ground, but is exposed to occasional sources of moisture, is considered to be a dry interior environment for the purpose of Sentence 9.23.2.4.(3).

**A-9.23.3.1.(2) Alternative Nail Sizes.** Where power nails or nails with a diameter smaller than that required by Tables 9.23.3.1. or 9.23.3.5.-C are used to connect framing, the following equations can be used to determine the required spacing or required number of nails.

The maximum spacing can be reduced using the following equation:

$$S_{\text{adj}} = S_{\text{table}} \times (D_{\text{red}}/D_{\text{table}})^2$$

where

$S_{\text{adj}}$  = adjusted nail spacing  $\geq 20 \times$  nail diameter,

$S_{\text{table}}$  = nail spacing required by Table 9.23.3.4. or 9.23.3.5.-A to 9.23.3.5.-C,

$D_{\text{red}}$  = nail diameter smaller than that required by Table 9.23.3.1., or 9.23.3.5.-C, and

$D_{\text{table}}$  = nail diameter required by Table 9.23.3.1. or 9.23.3.5.-C.

The number of nails can be increased using the following equation:

$$N_{adj} = N_{table} \times (D_{table}/D_{red})^2$$

where

$N_{adj}$  = adjusted number of nails,

$N_{table}$  = number of nails required by Table 9.23.3.4. or 9.23.3.5.-A to 9.23.3.5.-C,

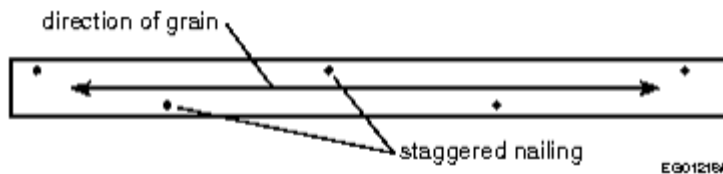
$D_{table}$  = nail diameter required by Table 9.23.3.1. or 9.23.3.5.-C, and

$D_{red}$  = nail diameter smaller than that required by Table 9.23.3.1. or 9.23.3.5.-C.

Note that nails should be spaced no less than 55 mm apart – to avoid splitting of framing lumber.

**A-9.23.3.1.(3) Standard for Screws.** The requirement that wood screws conform to ASME B18.6.1, “Wood Screws (Inch Series),” is not intended to preclude the use of Robertson head screws. The requirement is intended to specify the mechanical properties of the fastener, not to restrict the means of driving the fastener.

**A-9.23.3.3.(1) Prevention of Splitting.** Figure A-9.23.3.3.(1) illustrates the intent of the phrase “staggering the nails in the direction of the grain.”



**Figure A-9.23.3.3.(1)**

### Staggered nailing

**A-Table 9.23.3.5.-B Alternative Nail Sizes.** Where power nails or nails having a different diameter than the diameters listed in CSA B111, “Wire Nails, Spikes and Staples,” are used to connect the edges of the wall sheathing to the wall framing of wood-sheathed braced wall panels, the maximum spacing should be as shown in Table A-Table 9.23.3.5.-B.

**Table A-Table 9.23.3.5.-B  
Alternative Nail Diameters and Spacing**

Element	Nail Diameter, mm <sup>(1)</sup>	Maximum Spacing of Nails Along Edges of Wall Sheathing, mm o.c.
Plywood, OSB or waferboard	2.19–2.52	75
	2.53–2.82	100
	2.83–3.09	125
	>3.09	150

**Notes to Table A-Table 9.23.3.5.-B:**

<sup>(1)</sup> For alternative nail lengths of 63 mm or longer.

Note A-Table 9.23.3.5.-C Factored Shear Resistances and Framing Adjustment Factors. Table 9.23.3.5.-C describes the fastening of sheathing elements for each reference framing type available for use as a braced wall panel. There are three categories of framing type: wood-sheathed braced wall panels (WSP), diagonal (lumber) wood boards (DWB), and gypsum board (GWB). Table A-9.23.3.5.-C provides the factored shear resistances as per CSA O86 and framing adjustment

factors of the framing types listed in Table 9.23.3.5.-C, and can be used to calculate the minimum required length of braced wall panels using the alternative calculation procedures in Note A-9.23.13.7.(3) and A- 9.23.13.7.(4).

**Table A-Table 9.23.3.5.-C**  
**Factored Shear Resistances and Framing Adjustment Factors of Framing Types**

Reference Framing Type	Minimum Sheathing Element <sup>(1)</sup> and maximum stud spacing	Minimum Specification of Fasteners, mm		Minimum Number or Maximum Spacing of Fasteners <sup>(2)</sup> at Panel Edges to Framing	K <sub>Wframe</sub> <sup>(3)</sup>	K <sub>Sframe</sub> <sup>(4)</sup>	Factored shear resistance, kN/m
		Common, Spiral or Ring Thread	Screws				
GWB-O (interior side of WSP framing types)	12.5 mm gypsum for 600 mm stud spacing	2.48 mm diameter ring thread with 20 mm penetration into support framing <sup>(5)</sup>	3.45 mm shank diameter Type W with 20 mm penetration into support framing <sup>(6)</sup>	200 mm o.c. for nail 300 mm o.c. for screw	n/a	n/a	0.61 <sup>(7)</sup>
GWB-A	12.5 mm gypsum for 600 mm stud spacing			200 mm o.c. for nail 300 mm o.c. for screw	2.85	4.28	1.15 <sup>(8)</sup>
GWB-B	12.5 mm gypsum for 400 mm stud spacing			150 mm o.c. Or 200 mm o.c. for blocked	1.65	2.148	1.98 <sup>(8)</sup>
GWB-C	12.5 mm gypsum for 400 mm stud spacing or 12.5 mm gypsum for 600 mm stud spacing, blocked <sup>(9)</sup>			150 mm o.c. or 200 mm o.c. for blocked	1.23	1.84	2.67 <sup>(8)</sup>
GWB-D	12.5 mm gypsum for 400 mm stud spacing			100 mm o.c.	1.00	1.50	3.28 <sup>(8)</sup>
WSP-A	9.5 mm plywood, OSB or waferboard for 400 mm stud spacing	2.84 mm x 51 mm <sup>(10)</sup>	NP <sup>(11)</sup>	150 mm o.c.	1.00	1.00	3.28 <sup>(7)</sup>
WSP-B	11 mm plywood, OSB or waferboard,	3.25 mm x 63 mm <sup>(10)</sup>	NP <sup>(11)</sup>	150 mm o.c.	0.53	0.53	6.22 <sup>(7)</sup>



	blocked <sup>(9)</sup> for 600 mm stud spacing						
WSP-C	11 mm plywood, OSB or waferboard, blocked <sup>(9)</sup> for 600 mm stud spacing	3.25 mm x 63 mm <sup>(10)</sup>	NP <sup>(10)</sup>	100 mm o.c.	0.46	0.46	7.15 <sup>(7)</sup>
WSP-D	11 mm plywood, OSB or waferboard, blocked <sup>(9)</sup> for 600 mm stud spacing	3.25 mm x 63 mm <sup>(10)</sup>	NP <sup>(11)</sup>	75 mm o.c.	0.42	0.42	7.85 <sup>(7)</sup>
WSP-E	15,5 mm plywood, OSB or waferboard, blocked <sup>(9)</sup> for 600 mm stud spacing	3.66 mm x 63 mm <sup>(10)</sup>	NP <sup>(11)</sup>	75 mm o.c.	0.38	0.38	8.71 <sup>(7)</sup>
DWB	19 mm diagonal lumber board	3.25 mm x 63 mm <sup>(10)</sup>	3.25 mm x 51 mm <sup>(11)</sup>	2 per support framing where lumber width ≤ 184 mm 3 per support framing where lumber width > 184 mm	0.57	0.57	5.77 <sup>(7)</sup>

**Notes to Table A-Table 9.23.3.5.-C:**

<sup>(1)</sup> Plywood, OSB, waferboard and board lumber may be installed vertically or horizontally and shall conform to the material standards specified in Subsection 9.23.17. Gypsum sheathing shall meet the requirements of gypsum board in Subsection 9.29.5.

<sup>(2)</sup> For plywood, OSB or waferboard panel sheathing, the maximum fastener spacing along intermediate supports shall be 300 mm o.c. For gypsum sheathing, the maximum spacing along intermediate supports shall conform to Sentence 9.29.5.8.(4) for nails and Sentence 9.29.5.9.(4) for screws.

<sup>(3)</sup> See A-9.23.13.7.(3).

<sup>(4)</sup> See A-9.23.13.7.(4).

<sup>(5)</sup> Nails for GWB framing types shall meet the requirements of Article 9.29.5.6.

<sup>(6)</sup> Screws for GWB framing types shall meet the requirements of Article 9.29.5.7.

<sup>(7)</sup> All framing types are based on resistances derived from CSA O86. Factored shear resistances of WSP and DWB framing types include a contribution of 0.61 kN/m from GWB-O on opposite face of the *braced wall panel*. DWB resistance based on Spruce-Pine-Fir (SPF) studs and Northern Species diagonal lumber boards. Compared to CSA O86, WSP-C was reduced by a factor of 0.20, WSP-D was reduced by a factor of 0.30, and WSP-E was reduced by a factor of 0.40, to account for no hold-downs.

<sup>(8)</sup> GWB framing types are derived from allowable stress shear resistances (average peak shear divided by safety factor of 3) and soft converting to specified shear resistances consistent with practice used in CSA O86. The resulting factored resistance value is determined same as WSP framing types, except a resistance factor of 0.7 is applied for GWB instead of 0.8 applicable to WSP. The  $K_{sframe}$  factor also accounts for difference in seismic force modifiers for WSP ( $R_d = 3$ ) and GWB ( $R_d = 2$ ).

<sup>(9)</sup> Where blocking is required, horizontal panel sheathing joints shall occur over and be fastened to blocking of not less than 38 mm x 89 mm lumber oriented either edgewise or flatwise.

<sup>(10)</sup> Nails for WSP and DWB framing types shall meet the requirements of Article 9.23.3.1.

<sup>(11)</sup> NP = Not permitted

**A-9.23.4.2. Span Tables for Wood Joists, Rafters and Beams.** In these span tables the term “rafter” refers to a sloping wood framing member which supports the roof sheathing and encloses an attic space but does not support a ceiling. The term “roof joist” refers to a horizontal or sloping wood framing member that supports the roof sheathing and the ceiling finish but does not enclose an attic space.

Where rafters or roof joists are intended for use in a locality having a higher specified roof snow load than shown in the tables, the maximum member spacing may be calculated as the product of the member spacing and specified snow load shown in the span tables divided by the specified snow load for the locality being considered. The following examples show how this principle can be applied:

- (a) For a 3.5 kPa specified snow load, use spans for 2.5 kPa and 600 mm o.c. spacing but space members 400 mm o.c.
- (b) For a 4.0 kPa specified snow load, use spans for 2.0 kPa and 600 mm o.c. spacing but space members 300 mm o.c.

The maximum spans in the span tables are measured from the inside face or edge of support to the inside face or edge of support.

In the case of sloping roof framing members, the spans are expressed in terms of the horizontal distance between supports rather than the length of the sloping member. The snow loads are also expressed in terms of the horizontal projection of the sloping roof. Spans for odd size lumber may be estimated by straight line interpolation in the tables.

These span tables may be used where members support a uniform live load only. Where the members are required to be designed to support a concentrated load, they must be designed in conformance with Subsection 4.3.1.

Supported joist length in Span Tables 9.23.4.2.-H, 9.23.4.2.-I and 9.23.4.2.-J means half the sum of the joist spans on both sides of the beam. For supported joist lengths between those shown in the tables, straight line interpolation may be used in determining the maximum beam span.

Span Tables 9.23.4.2.-A to 9.23.12.3.-D cover only the most common configurations. Especially in the area of floors, a wide variety of other configurations is possible: glued subfloors, concrete toppings, machine stress rated lumber, etc. The Canadian Wood Council publishes “The Span Book,” a compilation of span tables covering many of these alternative configurations. Although these tables have not been subject to the formal committee review process, the Canadian Wood Council generates, for the CCBFC, all of the **By-law**'s span tables for wood structural components; thus **By-law** users can be confident that the alternative span tables in “The Span Book” are consistent with the span tables in the **By-law** and with relevant Code requirements.

Spans for wood joists, rafters and beams which fall outside the scope of these tables, including those for U.S. species and individual species not marketed in the commercial species combinations described in the span tables, can be calculated in conformance with CSA O86, “Engineering design in wood.”

**A-9.23.4.2.(2) Numerical Method to Establish Vibration-Controlled Spans for Wood-Frame Floors.** In addition to the normal strength and deflection analyses, the calculations on which the floor joist span tables are based include a method of ensuring that the spans are not so long that floor vibrations could lead to occupants perceiving the floors as too “bouncy” or “springy.” Limiting deflection under the normal uniformly distributed loads to 1/360 of the span does not provide this assurance.

Normally, vibration analysis requires detailed dynamic modeling. However, the calculations for the span tables use the following simplified static analysis method of estimating vibration-acceptable spans:

- The span which will result in a 2 mm deflection of a single joist supporting a 1 kN concentrated midpoint load is calculated.
- This span is multiplied by a factor, K, to determine the “vibration-controlled” span for the entire floor system. If this span is less than the strength- or deflection-controlled span under uniformly distributed load, the vibration-controlled span becomes the maximum span.
- The K factor is determined from the following relationship:

$$\ln(K) = A - B \times \ln(S_i/S_{184}) + G$$

where

A, B = constants, the values of which are determined from Tables A-9.23.4.2.(2)-A or A-9.23.4.2.(2)-B,

G = constant, the value of which is determined from Table A-9.23.4.2.(2)-C,

$S_i$  = span which results in a 2 mm deflection of the joist in question under a 1 kN concentrated midpoint load,

$S_{184}$  = span which results in a 2 mm deflection of a 38 × 184 mm joist of same species and grade as the joist in question under a 1 kN concentrated midpoint load.

For a given joist species and grade, the value of K shall not be greater than  $K_3$ , the value which results in a vibration-controlled span of exactly 3 m. This means that for vibration-controlled spans 3 m or less, K always equals  $K_3$ , and for vibration-controlled spans greater than 3 m, K is as calculated.

Note that, for a sawn lumber joist, the ratio  $S_i/S_{184}$  is equivalent to its depth (mm) divided by 184.

Due to rounding differences, the method, as presented here, might produce results slightly different from those produced by the computer program used to generate the span tables.

**Table A-9.23.4.2.(2)-A**

**Constants A and B for Calculating Vibration-Controlled Floor Joist Spans – General Cases**

Subfloor Thickness, mm	With Strapping <sup>(1)</sup>			With Bridging			With Strapping and Bridging		
	Joist Spacing, mm			Joist Spacing, mm			Joist Spacing, mm		
	300	400	600	300	400	600	300	400	600
Constant A									
15.5	0.30	0.25	0.20	0.37	0.31	0.25	0.42	0.35	0.28
19.0	0.36	0.30	0.24	0.45	0.37	0.30	0.50	0.42	0.33
Constant B									
	0.33			0.38			0.41		

**Notes to Table A-9.23.4.2.(2)-A:**

<sup>(1)</sup> Gypsum board attached directly to joists can be considered equivalent to strapping.

**Table A-9.23.4.2.(2)-B**

### Constants A and B for Calculating Vibration-Controlled Floor Joist Spans – Special Cases

Subfloor Thickness, mm	Joists with Ceiling Attached to Wood Furring <sup>(1)</sup>						Joists with Concrete Topping <sup>(2)</sup>		
	Without Bridging			With Bridging			With or Without Bridging		
	Joist Spacing, mm			Joist Spacing, mm			Joist Spacing, mm		
	300	400	600	300	400	600	300	400	600
	Constant A								
15.5	0.39	0.33	0.24	0.49	0.44	0.38	0.58	0.51	0.41
19.0	0.42	0.36	0.27	0.51	0.46	0.40	0.62	0.56	0.47
	Constant B								
	0.34			0.37			0.35		

**Notes to Table A-9.23.4.2.(2)-B:**

<sup>(1)</sup> Wood furring means 19 × 89 mm boards not more than 600 mm o.c., or 19 × 64 mm boards not more than 300 mm o.c. For all other cases, see Table A-9.23.4.2.(2)-A.

<sup>(2)</sup> 30 mm to 51 mm normal weight concrete (not less than 20 MPa) placed directly on the subflooring.

**Table A-9.23.4.2.(2)-C**

### Constant G for Calculating Vibration-Controlled Floor Joist Spans

Floor Description	Constant G
Floors with nailed <sup>(1)</sup> subfloor	0.00
Floor with nailed and field-glued <sup>(2)</sup> subfloor, vibration-controlled span greater than 3 m	0.10
Floor with nailed and field-glued <sup>(2)</sup> subfloor, vibration-controlled span 3 m or less	0.15

**Notes to Table A-9.23.4.2.(2)-C:**

<sup>(1)</sup> Common wire nails, spiral nails or wood screws can be considered equivalent for this purpose.

<sup>(2)</sup> Subfloor field-glued to floor joists with elastomeric adhesive complying with CAN/CGSB-71.26-M, "Adhesive for Field-Gluing Plywood to Lumber Framing for Floor Systems."

Additional background information on this method can be found in the following publications:

- Onysko, D.M. "Deflection Serviceability Criteria for Residential Floors." Project 43-10C-024. Forintek Canada Corp., Ottawa, Canada 1988.
- Onysko, D.M. "Performance and acceptability of wood floors – Forintek studies." Proceedings of Symposium/Workshop on Serviceability of Buildings, Ottawa, May 16-18, National Research Council of Canada, Ottawa, 1988.

**A-9.23.4.3.(1) Maximum Spans for Steel Beams Supporting Floors in Dwellings.** A beam may be considered to be laterally supported if wood joists bear on its top flange at intervals of 600 mm or less over its entire length, if all the load being applied to this beam is transmitted through the joists and if 19 mm by 38 mm wood strips in contact with the top flange are nailed on both sides of the beam to the bottom of the joists supported. Other additional methods of positive lateral support are acceptable.

For supported joist lengths intermediate between those in the table, straight line interpolation may be used in determining the maximum beam span.

A-Table 9.23.4.3. Spans for Steel Beams. The spans provided in Table 9.23.4.3. reflect a balance of engineering and acceptable proven performance. The spans have been calculated based on the following assumptions:

- simply supported beam spans
- laterally supported top flange
- yield strength 350 MPa
- deflection limit  $L/360$
- live load: first floor = 1.9 kPa; second floor = 1.4 kPa
- dead load: 1.5 kPa (0.5 kPa floor + 1.0 kPa partition)

The calculation used to establish the specified maximum beam spans also applies a revised live load reduction factor to account for the lower probability of a full live load being applied over the supported area in Part 9 buildings.

**A-9.23.4.4. Concrete Topping.** Vibration-controlled spans given in Span Table 9.23.4.2.-B for concrete topping are based on a partial composite action between the concrete, subflooring and joists. Normal weight concrete having a compressive strength of not less than 20 MPa, placed directly on the subflooring, provides extra stiffness and results in increased capacity. The use of a bond breaker between the topping and the subflooring, or the use of lightweight concrete topping limits the composite effects.

Where either a bond breaker or lightweight topping is used, Span Table 9.23.4.2.-A may be used but the additional dead load imposed by the concrete must be considered. The addition of 51 mm of concrete topping can impose an added load of 0.8 to 1.2 kPa, depending on the density of the concrete.

#### Example 1

Assumptions:

- basic dead load	= 0.5 kPa
- topping dead load	= 0.8 kPa
- total dead load	= 1.3 kPa
- live load	= 1.9 kPa
- vibration limit	per Note A-9.23.4.2.(2)
- deflection limit	= $1/360$
- ceiling attached directly to joists, no bridging	

The spacing of joists in the span tables can be conservatively adjusted to allow for the increased load by using the spans in Span Table 9.23.4.2.-A for 600 mm spacing, but spacing the joists 400 mm apart. Similarly, floor beam span tables can be adjusted by using 4.8 m supported length spans for cases where the supported length equals 3.6 m.

#### A-9.23.6.1.(3) Anchorage of Building Frames.

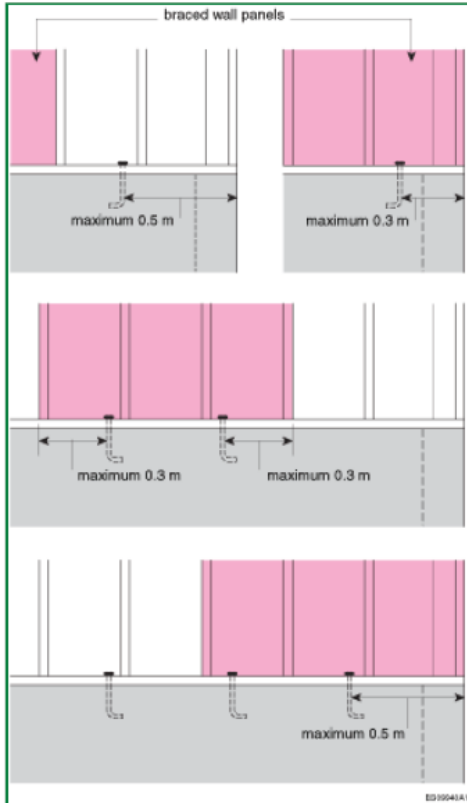


Figure A-9.23.6.1.(3)

Anchorage of Building Frames

A-9.23.8.3. Joint Location in Built-Up Beams.

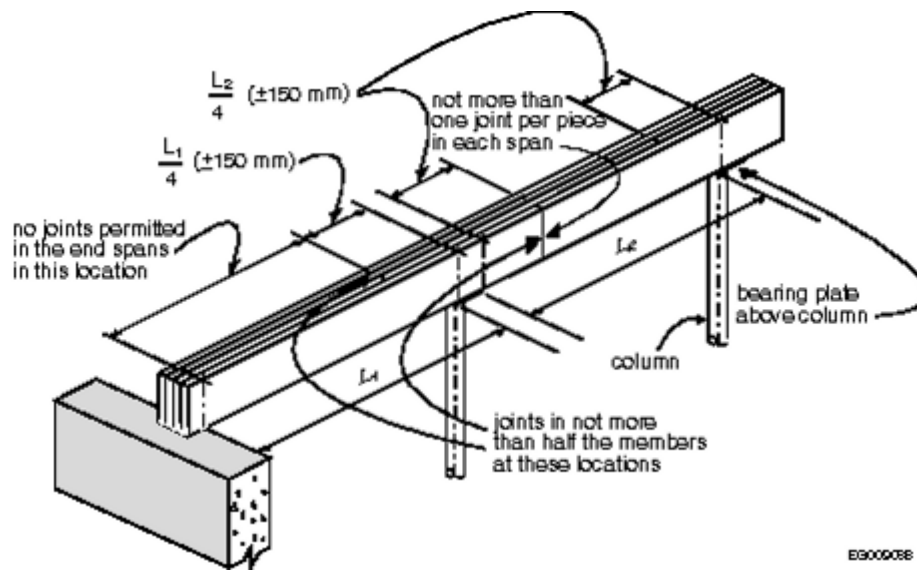
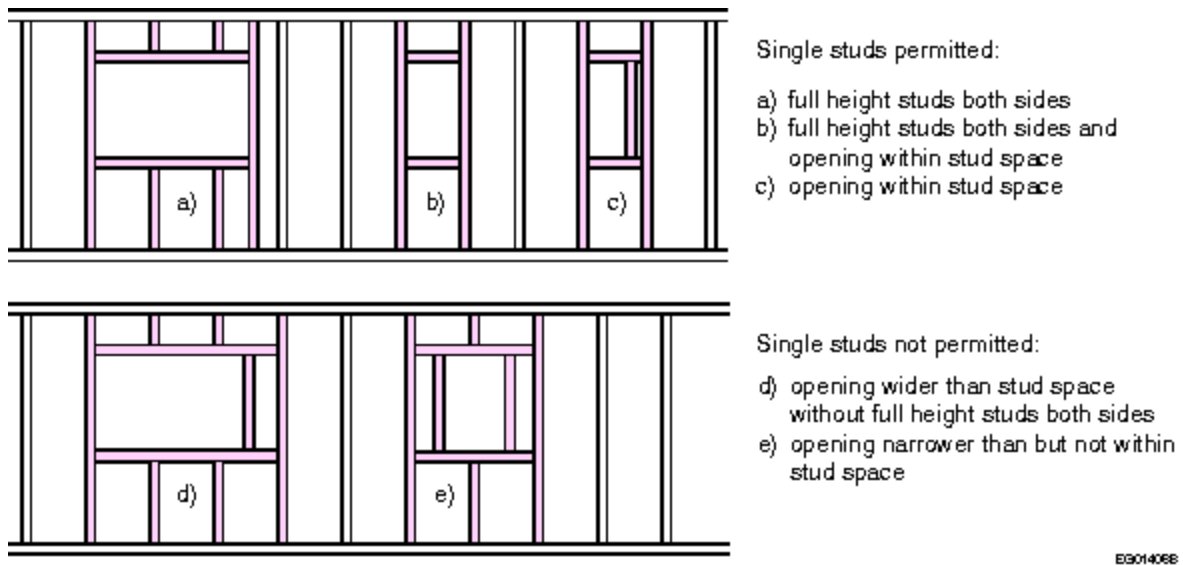


Figure A-9.23.8.3.

Joint location in built-up beams

**A-9.23.10.4.(1) Fingerjoined Lumber.** NLGA 2017, “Standard Grading Rules for Canadian Lumber,” referenced in Article 9.3.2.1., refers to two special product standards, SPS-1, “Fingerjoined Structural Lumber,” and SPS-3, “Fingerjoined “Vertical Stud Use Only” Lumber,” produced by NLGA. Material identified as conforming to these standards is considered to meet the requirements in this Sentence for joining with a structural adhesive. Lumber fingerjoined in accordance with SPS-3 should be used as a vertical end-loaded member in compression only, where sustained bending or tension-loading conditions are not present, and where the moisture content of the wood will not exceed 19%. Fingerjoined lumber may not be visually regraded or remanufactured into a higher stress grade even if the quality of the lumber containing fingerjoints would otherwise warrant such regrading.

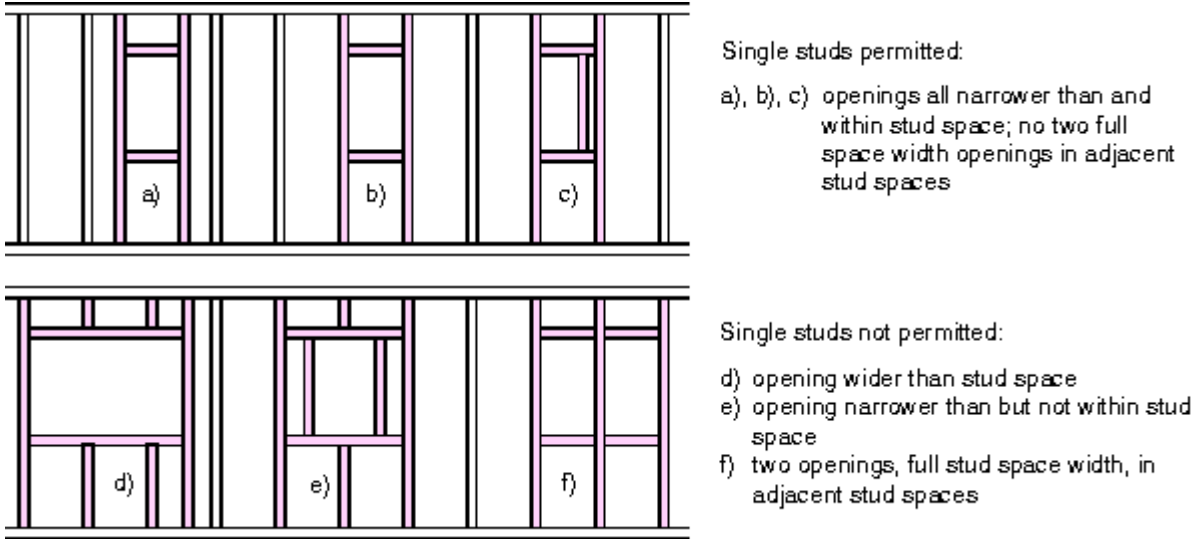
**A-9.23.10.6.(3) Single Studs at Sides of Openings.**



EG014068

Figure A-9.23.10.6.(3)-A

Single studs on sides of openings in non-loadbearing interior walls not required to have a fire-resistance rating



E9014068

Figure A-9.23.10.6.(3)-B

**Single studs on sides of openings in all other walls**

**A-9.23.13. Bracing for Resistance to Lateral Loads.** Subsection 9.23.13. along with Articles 9.4.2.5., 9.23.3.4., 9.23.3.5., 9.23.6.1., 9.23.9.8., 9.23.11.4., 9.23.15.5., 9.29.5.8., 9.29.5.9., 9.29.6.3. and 9.29.9.3. contain design and bracing provisions that address the resistance of light wood-frame structures and non-structural components to wind and earthquake loads.

The bracing provisions were developed based on a combination of performance history and engineering calculations, as are most Part 9 provisions. The placement and construction methods for braced walls were determined by the following approach. The lateral forces were analyzed in accordance with Part 4 for various configurations of buildings in different locations across Canada. The lateral resistance of walls was established using an approach adapted from CSA O86, "Engineering Design in Wood." Construction details and required lengths for braced walls were determined based on location, building height, wind exposed class and construction weight. This approach relied on the following assumptions:

- A short-term load duration factor, KD, of 1.25 was used for the calculation of resistance to wind and seismic shear forces.
- The ductility- and overstrength-related seismic force modification factors, Rd and Ro, were assumed to have the values listed in the following table:

Seismic Force Resisting System (SFRS)	R <sub>d</sub>	R <sub>o</sub>
Nailed or screwed wood-based shear walls in combination with gypsum board	3.0	1.7
Nailed or screwed diagonal lumber board shear walls in combination with gypsum board	3.0	1.7
Nailed or screwed gypsum board shear walls	2.0	1.7

- A level of resistance of up to 50% of the wind or seismic lateral load demand was assumed to be provided by interior partitions, and other non-structural components, such as cabinetry and cladding.



It is important to note that not all buildings satisfying the bracing provisions will have the configurations or details assumed in the calculations, which are necessary to provide adequate resistance against lateral loads. For example, buildings that have limited interior partitions and other non-structural components may have a lower lateral resistance than predicted. In such cases, the Part 9 provisions for bracing to resist lateral loads may not be adequate to satisfy the objectives of the British Columbia Building Code, and bracing requirements should instead be determined in accordance with Part 4. See Note A-9.4.2.5. for more information on the seismic design parameter,  $S_{max}$ , used in the seismic design provisions.

#### **A-9.23.13.1.**

##### **Bracing to Resist Lateral Loads in Low Load Locations**

**For** locations identified in Appendix C, where the seismic spectral acceleration,  $S_a(0.2)$ , is less than or equal to 0.70 and the 1-in-50 hourly wind pressure is less than 0.80, Sentence 9.23.13.1.(2) requires only that exterior walls be braced using the acceptable materials and fastening specified. There are no spacing or dimension requirements for braced wall panels in these buildings.

##### **Structural Design for Lateral Wind and Earthquake Loads**

In cases where lateral load design is required, CWC 2014, "Engineering Guide for Wood Frame Construction," provides acceptable engineering solutions as an alternative to Part 4. The CWC Guide also contains alternative solutions and provides information on the applicability of the Part 9 prescriptive structural requirements to further assist designers and building officials to identify the appropriate design approach.

#### **A-9.23.13.2.(3) Weights of Construction.**

##### **Normal Weight Construction**

Normal-weight floor construction (0.5 kPa) accommodates ceramic tile, hardwood, carpet and other finishes weighing no more than 0.25 kPa. Normal-weight roof construction (0.5 kPa) accommodates asphalt shingles, wood shingles, steel roofing and other roofing weighing no more than 0.12 kPa. Normal-weight wall construction (0.4 kPa) accommodates fibre cement board, wood, vinyl, lightweight metal panels weighing no more than 0.10 kPa.

These cladding weights are based on the typical light wood frame construction:

- Floor assembly: plywood subfloor, 2×2 lumber floor joists at 400 mm o.c. and gypsum board ceiling;
- Roof assembly: plywood roof sheathing, trusses, R60 insulation, gypsum board ceiling;
- Wall assembly: OSB exterior sheathing, strapping, 2×6 studs at 400 mm o.c., insulation, gypsum board interior finish

##### **Heavy Weight Construction**

In a building of "heavy weight construction," the average dead weight per storey of floors, roof or exterior walls is permitted to exceed the value stated in Clause 9.23.13.2.(3)(a), but must not exceed the maximum average dead weights per storey stated in Clause 9.23.13.2.(3)(b). The heavy weight floor construction provisions account for an additional total dead load of 1.0 kPa compared to the normal weight floor construction, accommodating, for example, a 38 mm normal-weight concrete topping. Heavy-weight roof construction, accommodates lighter roofing materials to be replaced with slate or clay tile shingles weighing up to 0.65 kPa (provided the heavy roofing is not installed over existing normal weight roofing). The heavy-weight roof construction provisions also accommodate the installation of solar panels over normal weight

roofing such as asphalt shingles. Solar panels add approximately 0.12 kPa to the roof. Heavy-weight wall construction provisions account for cladding weighing up to 0.85 kPa, when this heavier cladding replaces normal weight cladding. This accommodates cementitious stucco, heavier weight metal panels, and, if averaged with lighter claddings, adhered manufactured or natural stone veneer. Heavy weight wall construction does not accommodate masonry or stone veneer except where advantage can be made of “Area-weighted Average”. The maximum average dead weights per storey for the three cases are listed in Table A- 9.23.13.2.(3).

**Table A-9.23.13.2.(3)**  
**Maximum Average Dead Weights per Storey for Heavy Weight Construction**  
**Forming Part of Note A-9.23.13.2.(3)**

Description of Heavy Weight Construction	Maximum Average Dead Weight per Storey, kPa			
	Floors	Partitions and Interior Walls	Roof	Exterior Walls
Normal weight floors and roof with heavy weight exterior walls	0.5	0.5	0.5	1.2
Normal weight floors and exterior walls with heavy weight roof	0.5	0.5	1.0	0.4
Normal weight exterior walls and roof with heavy weight floors	1.5	0.5	0.5	0.4

#### Masonry and Stone Veneer Wall Cladding

Braced wall panels that run perpendicular to masonry- and stone veneered walls are required to have a comparatively higher lateral strength to resist increased lateral loading due to the relatively higher wall mass of the masonry. The effects of mass are accounted for using the  $K_{weight}$  factor listed in Table 9.23.13.7-D. Under seismic action, lateral load due to the mass of a masonry or stone veneer is transferred into the wall immediately behind the veneer, which under the load path and by diaphragm action, is transferred into the roof and floors and is resisted by the braced wall panels oriented parallel to the seismic motion (perpendicular to the veneer). Therefore, only braced wall panels running perpendicular to the masonry or stone veneered walls are required to be adjusted by the  $K_{weight}$  adjustment factor. If the entire building is clad with masonry or stone veneer, all braced wall panels are required to be adjusted by the appropriate masonry or stone “both faces”  $K_{weight}$  adjustment factor. If only two parallel faces of a four-sided building are clad with masonry or stone veneer, only the side-yard braced wall panels are required to be adjusted using the appropriate masonry or stone “both faces”  $K_{weight}$  adjustment factor. If only one face of the building is clad with masonry or stone veneer, the side-yard braced wall panels are required to be adjusted with the “one face”  $K_{weight}$  adjustment factor.

For buildings clad with masonry veneer, the following veneer products with a bed thickness of not more than 90 mm are considered to meet the weight limit of 1.9 kPa:

- clay brick masonry veneer
- concrete block masonry veneer
- concrete brick masonry veneer
- concrete stone masonry veneer
- calcium silicate masonry veneer

For buildings clad with stone veneers, natural stone veneer of limestone and sandstone, excluding granite, with a bed thickness of not more than 125 mm are considered to meet the weight limit of 3.2 kPa.

## Area-weighted Average

The concept of area-weighted average is an important consideration for cost-effective construction and wall bracing compliance. Depending upon the relative weights and areas of materials, less rigorous bracing requirements could apply to the structure using the concept of 'area-weighted average'. It is based on averaging the cumulative sum of material weights over their respective areas. Averaging of material weights applies per assembly. Using area-weighted average, for example, wall cladding weights can be averaged for the entire building's wall areas to determine if normal or heavy construction apply under the per storey average dead weight limits stated in Table A-9.23.13.2.(3). A building with walls partially clad with comparatively heavier materials may qualify as normal weight construction if the area-weight contribution of the normal weight cladding materials combined with that of heavy weight cladding materials, such as stucco, masonry veneer or stone veneer, does not exceed the average dead weight limit of 0.4 kPa for normal weight construction. Similarly, a building with walls partially clad with masonry or stone veneer may qualify as heavy weight construction if the area-weighted average contribution of the normal or heavy weight cladding materials combined with that of masonry or stone veneer does not exceed the average dead weight limit of 1.2 kPa for heavy weight construction. This same concept applies to floor and roof assemblies.

Example: Area-weighted average floor calculation

For example, if a building has 400 m<sup>2</sup> of floor area, and 25 m<sup>2</sup> of that floor area has a concrete topping (floor assembly = 1.25 kPa), and the remaining 375 square metres has hardwood floors (floor assembly = 0.45 kPa), the area-weighted average dead weight is:

$$\frac{(1.25 \text{ kPa})(25 \text{ m}^2) + (0.45 \text{ kPa})(375 \text{ m}^2)}{400 \text{ m}^2} = 0.5 \text{ kPa}$$

Therefore, qualifies as normal weight construction.

A-9.23.13.4. Braced Wall Bands. Article 9.23.13.4. specifies the required characteristics of braced wall bands and their position in the building. Figures A-9.23.13.4.-A, A-9.23.13.4.-B and A-9.23.13.4.-C illustrate these requirements.

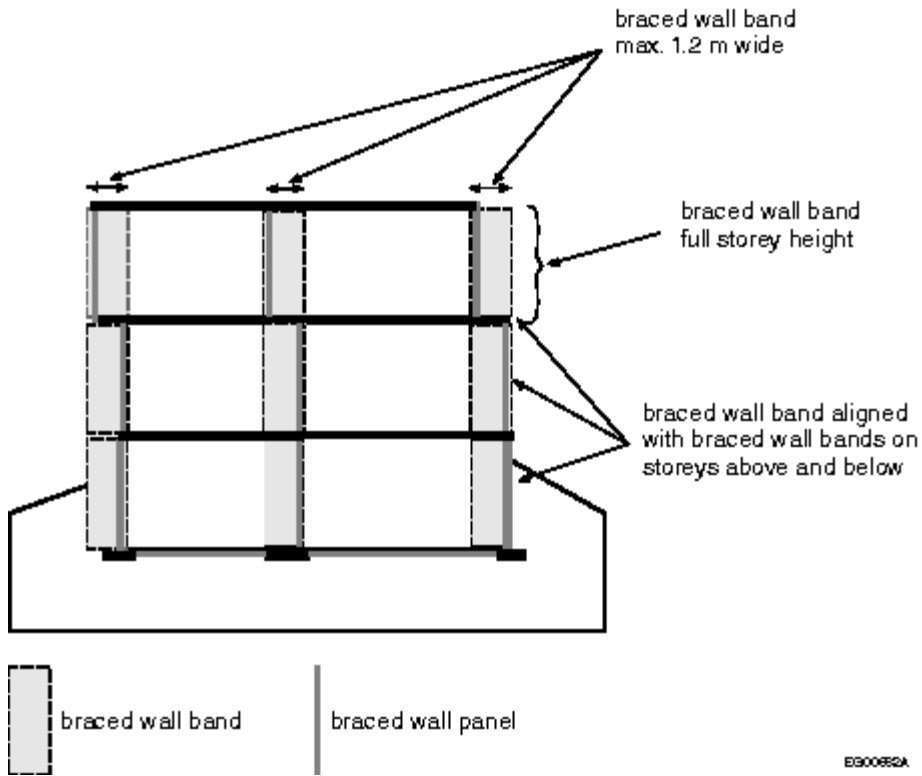


Figure A-9.23.13.4.-A

Braced wall bands in an example building section [ Clauses (a), (b), (c) and (d)]

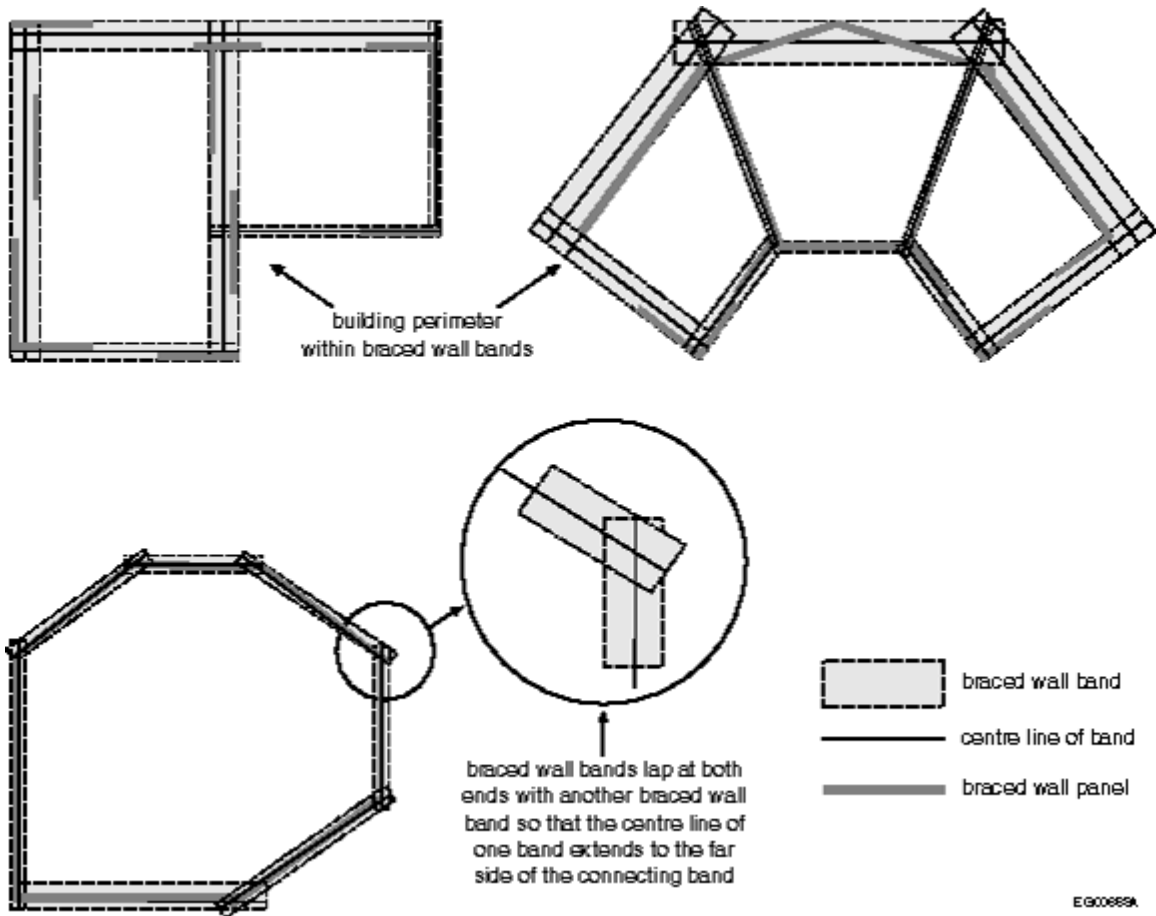


Figure A-9.23.13.4.-B

Lapping bands and building perimeter within braced wall bands [Clauses 9.23.13.4.(1)(a) and (c)]

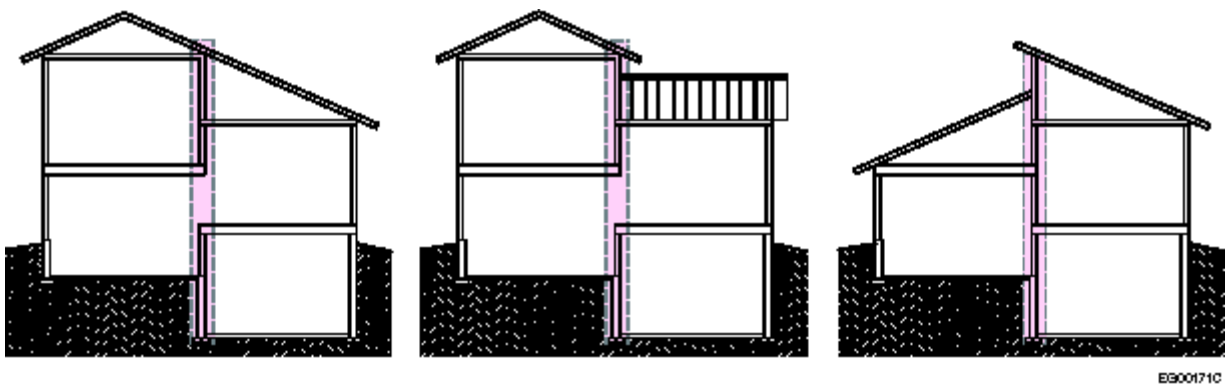
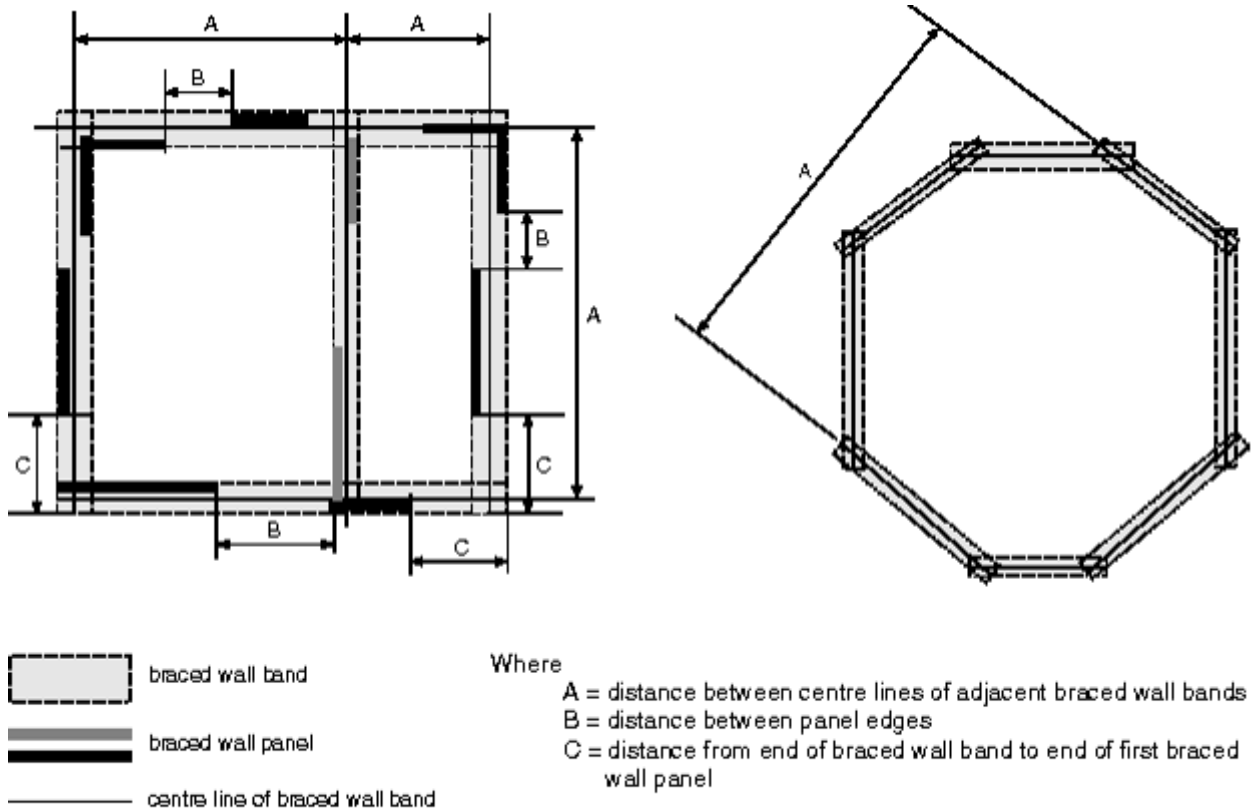


Figure A-9.23.13.4.-C

Braced wall bands at changes in floor level in split-level buildings [Sentence 9.23.13.4.(2)]

**A-Table 9.23.13.5. Spacing of Braced Wall Bands and Braced Wall Panels.** Identifying adjacent braced wall bands and determining the spacing of braced wall panels and braced wall bands is not complicated where the building plan is orthogonal or there are parallel braced wall bands: the adjacent braced wall band is the nearest parallel band. Figure Table A-9.23.13.5.-A illustrates spacing.



EG0084A

**Figure Table A-9.23.13.5.-A**

**Spacing of parallel braced wall bands and spacing of braced wall panels**

**Identifying and Spacing Adjacent Non-Parallel Braced Wall Bands**

Identifying the adjacent braced wall band and the spacing between braced wall bands is more complicated where the building plan is not orthogonal.

Where the plan is triangular, all braced wall bands intersect with the subject braced wall band. The prescriptive requirements in Part 9 do not apply to these cases and the building must be designed according to Part 4 with respect to lateral load resistance.

Where the braced wall bands are not parallel, the adjacent band is identified as follows using Figure Table A-9.23.13.5.-B as an example:

1. Determine the mid-point of the centre line of the subject braced wall band (A);
2. Project a perpendicular line from this mid-point (B);
3. The first braced wall band encountered is the adjacent braced wall band (C);

4. Where the projected line encounters an intersection point between two braced wall bands, either wall band may be identified as the adjacent braced wall band (complex cases).

The spacing of non-parallel braced wall bands is measured as the greatest distance between the centre lines of the bands.

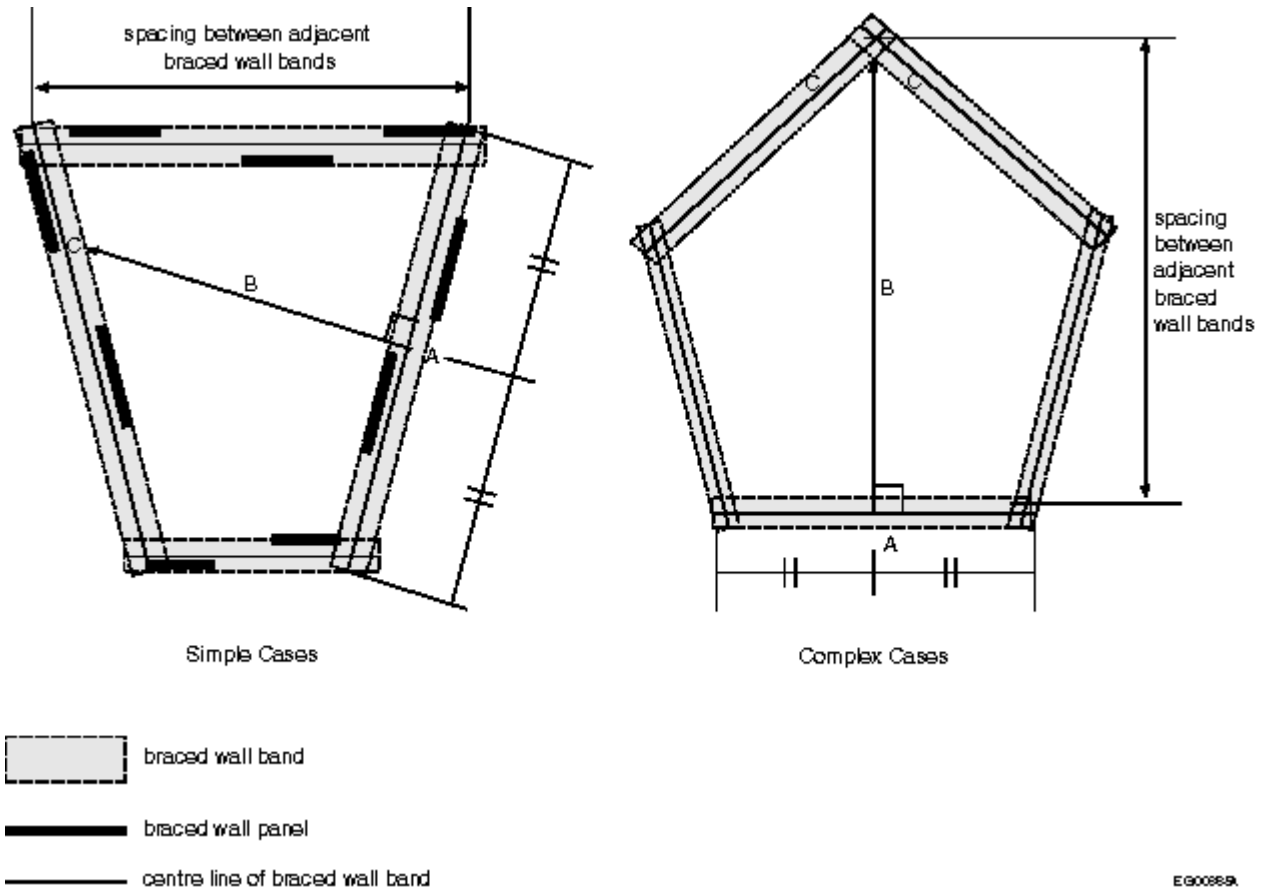


Figure Table A-9.23.13.5.-B

**Identification and spacing of adjacent non-parallel braced wall bands**

**A-9.23.13.5.(2) Perimeter Foundation Walls.** Where the perimeter foundation walls in basements and crawl spaces extend from the footings to the underside of the supported floor, these walls perform the same function as braced wall bands with braced wall panels. All other braced wall bands in the basement or crawl space that align with bands with a wood-based bracing material on the upper floors need to be constructed with braced wall panels, which must be made of a wood-based bracing material, masonry or concrete. See Figure A-9.23.13.5.(2).

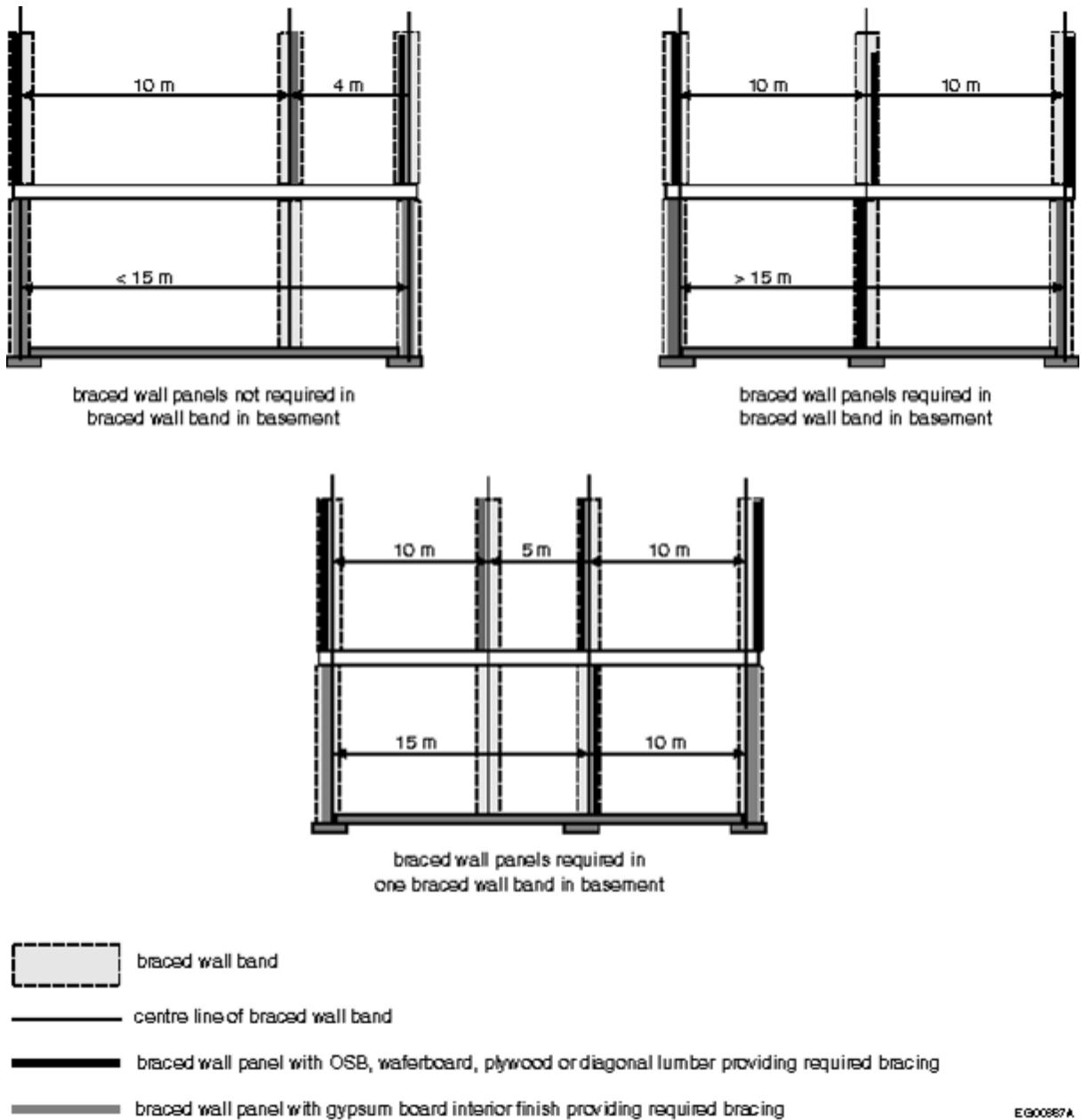


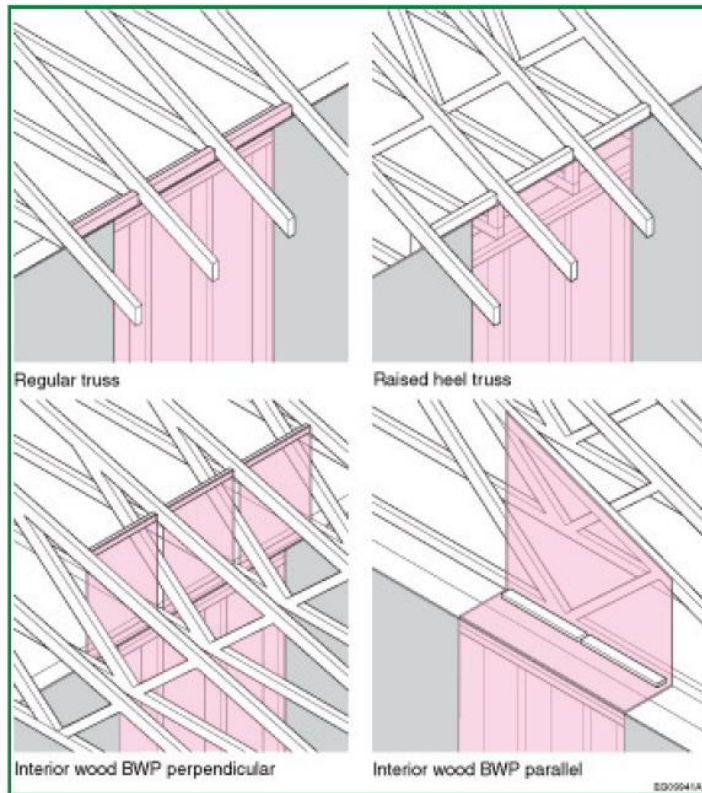
Figure A-9.23.13.5.(2)

**Braced wall bands in basements or crawl spaces with optional and required braced wall panels**

**A-9.23.13.5.(3) and (4) Connection of Braced Wall Panels to Roof Framing.** Braced wall panels that are sheathed with gypsum board alone have a significantly lower lateral resistance than woodsheathed braced wall panels. For gypsum-sheathed braced wall panels, the typical lateral bracing of trusses is usually adequate to transfer the lateral loads from the bottom chords to the top chords of the truss.



The connection of interior gypsum-sheathed braced wall panels to trusses also needs to accommodate vertical movement of the roof framing in order to facilitate “truss uplift” and to prevent the gypsum board from cracking.



**Figure A-9.23.13.5.(3) and (4)**

**Wood-sheathed braced wall panel to roof framing connection details (Sentence 9.23.13.5.(3)(a) and (b))**

**A-9.23.13.6.(1) Materials in Braced Wall Panels.** Clause 9.23.13.6.(1)(a) describes wood-based exterior braced wall panels, which includes gypsum board on the interior, ‘regularly attached’ according to Subsection 9.29.5. This corresponds with framing types WSP-A, WSP-B, WSP-C, WSP-D, WSP F and DWB, with GWB-O on the interior, as described in 9.23.3.5.(3). Clause 9.23.13.6.(1)(b) describes exterior braced wall panels sheathed with gypsum board only, typically applied to the interior side of the exterior walls, accommodating the option of no wood-based structural sheathing on the exterior side of the braced walls. This corresponds to framing types GWB-O, GWB-A, GWB-B, GWB-F, and GWB-H.

**A-9.23.13.6.(3) Use of Gypsum Board to Provide Required Bracing.** Braced wall panels constructed with gypsum board alone provide less resistance to lateral loads than panels constructed with OSB, waferboard, plywood or diagonal lumber board; Sentence 9.23.13.6.(3) limits the use of gypsum board to interior walls. Sentence (6) further limits its use to provide the required lateral resistance by requiring that walls in basements and crawl spaces be constructed with braced wall panels made of wood-based sheathing at braced wall band intervals of not more than 15 m apart. See Figure A-9.23.13.6.(3).

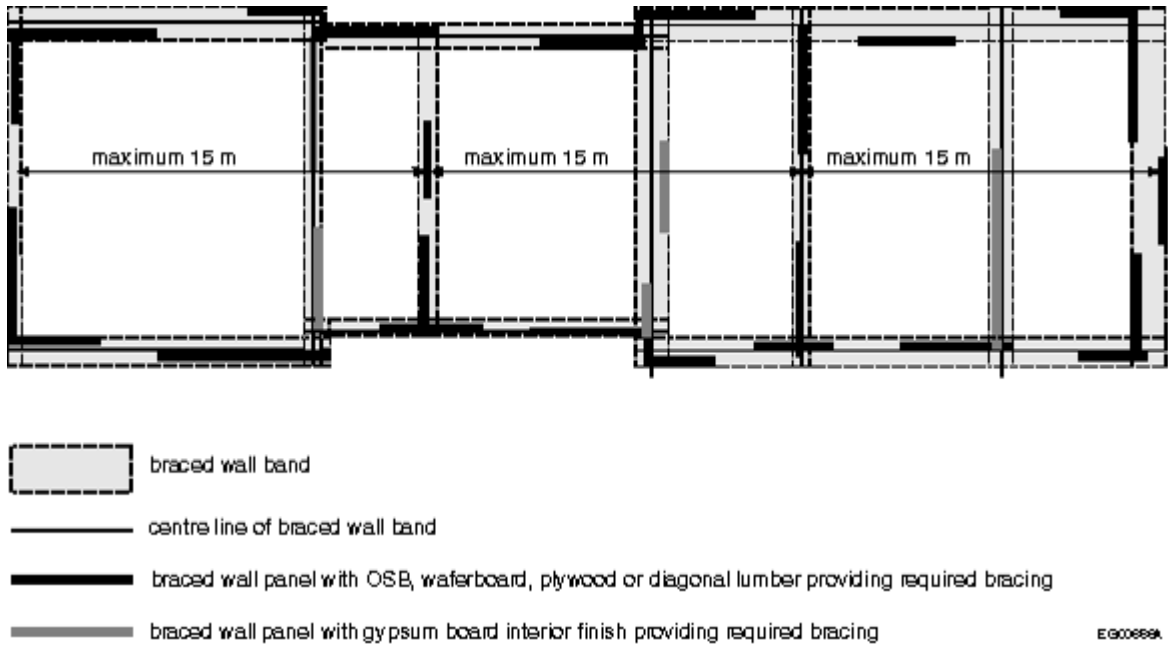


Figure A-9.23.13.6.(3)

**Braced wall panels constructed of wood-based material**

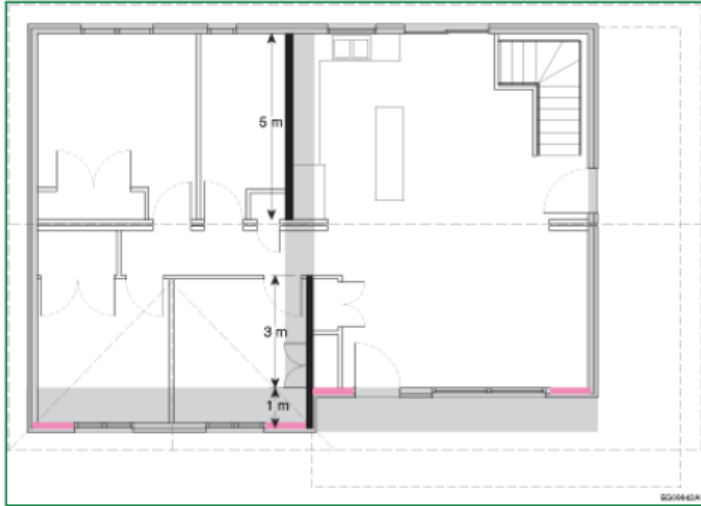
**A-9.23.13.6.(5) Mixed Braced Wall Panel Framing Types in Braced Wall Bands.**

The primary reason for mixed braced wall panel framing types is to accommodate where an interior GWB-sheathed braced wall panel framing type aligns with an exterior WSP braced wall panel framing type, along the same braced wall panel as shown in the plan view below. This permission is restricted to GWB- and 'low strength' WSP-sheathed framing types A and B. Mixing high strength or very stiff walls with low strength or less stiff walls has not been sufficiently studied and therefore requires analysis based on engineering principles.

This appendix note provides examples of complying with the requirements of Sentence 9.23.13.6.(5) when mixed braced wall panels are present along a braced wall band. Example 1 is the reference case without mixed sheathing types. Compliance to requirements in Clause 9.23.13.6.(5)(a) is demonstrated in Example 2, for the same braced wall band in Example 1.

**Example 1 - One sheathing type in all braced wall panels**

A braced wall band (B) consists of an exterior wall of 1 meter (at braced wall band 2) which continues into the building as an interior wall of 3 m and another interior wall 5 m for a total length = 1 + 3 + 5 = 9 m. The wall construction along B qualifies as GWB-B braced wall panel type. It is determined that a total braced wall panel length of 8 m is required if constructed as GWB-B. Therefore, there is sufficient wall length for the GWB-B braced wall panel along braced wall band B.

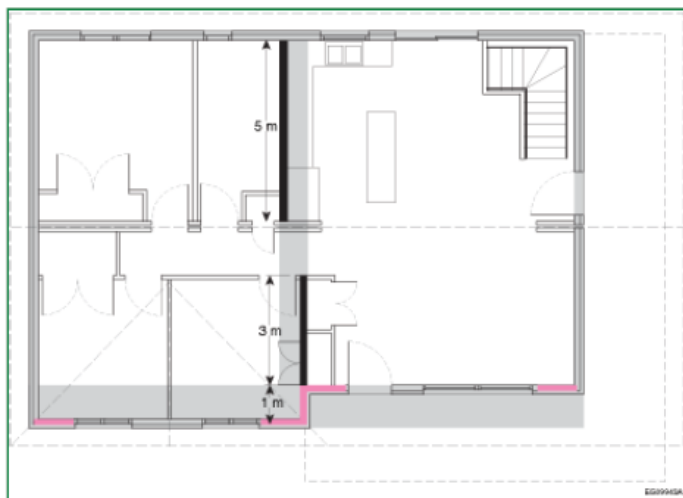


**Figure A-9.23.13.6.(5)-A**

**One sheathing type in all braced wall panels**

Example 2 - Mixed sheathing types in all braced wall panels using direct length substitution approach

The exterior walls are constructed with wood sheathing, and qualify as WSP-A braced wall panels. The builder would like to substitute the 1m portion of GWB-B braced wall panel construction with WSP-A exterior braced wall panel. Clause 9.23.13.6.(5)(a) permits a direct substitution, determined using the longest calculated braced wall panel length of all sheathing types in the braced wall band. In this case, the required length of braced wall panel is 8 m of GWB-B or 5.5 m of WSP-A. Therefore in this scenario, 5 m (GWB-B) + 3 m (GWB-B) + 1 m (WSP-A) = 9 m > 8 m, meets the requirement in Clause 9.23.13.6.(5)(a).



**Figure A-9.23.13.6.(5)-B**

**Mixed sheathing types in all braced wall panels using direct length substitution approach**

**A-9.23.13.7.(3) Alternate Procedure to Calculate Wind-related Required Braced Wall Panel Length.** To facilitate calculations of prescribed braced wall panel lengths, the wind-related minimum total unadjusted braced wall panel lengths,  $L_{uw}$ , are provided in Table 9.23.13.7.-A for categories of 1-in-50-year hourly wind pressure (HWP). The values provided within each HWP category are based on the highest HWP in the category, and must be adjusted by the factors provided in Table 9.23.13.7.-C. In lieu of the method given in Sentence 9.23.13.7.(3), the minimum required total braced wall length for wind,  $L_w$  is permitted to be calculated directly using the following equation:

$$L_w = C_{Wstorey} K_{Wframe} HWP (K_{exp} K_{roof} K_{Wspacing} K_{Wnumber} K_{gyp} K_{sheath}) \geq BWP_{min}$$

Where:

- $C_{Wstorey}$  = coefficient for storey location, for wind
  - = 3.84 for braced wall panels supporting roof only
  - = 7.89 for braced wall panels supporting roof + 1 floor
  - = 11.93 for braced wall panels supporting roof + 2 floors
- $K_{Wframe}$  = adjustment factor for framing type used in lieu of the unadjusted length for wind braced  $L_{uw}$ , given in Table A-9.23.13.7.(3)
- HWP = 1-in-50 year hourly wind pressure, kPa
- $K_{exp}$  = wind exposure adjustment
  - = 1.0 for 7.6 m braced wall band spacing
- $K_{roof}$  = roof eave-to-ridge height adjustment, for wind
  - = 1.0 for 3 m
- $K_{Wspacing}$  = braced wall band spacing adjustment for wind per building plan direction
  - = 1.0 for 7.6 m braced wall band spacing
- $K_{Wnumber}$  = number of braced wall bands adjustment for wind per building plan direction
  - = 1.0 for no intermediate braced wall bands between exterior walls
- $K_{gyp}$  = interior gypsum board adjustment
  - = 1.0 for braced wall panels with interior gypsum board
- $K_{sheath}$  = intermittent braced wall panels adjustment
  - = 1.0 for braced wall bands with continuously wood-sheathed exterior walls
- $BWP_{min}$  = Minimum length of individual braced wall panels as per Table 9.23.13.5.

Values for adjustment factors,  $K_{exp}$ ,  $K_{roof}$ ,  $K_{Wspacing}$ ,  $K_{Wnumber}$ ,  $K_{gyp}$  and  $K_{sheath}$  are provided in Table 9.23.13.7.-B

**Table A-9.23.13.7.(3)**  
**Wind-related Framing Adjustment Factor,  $K_{Wframe}$**

Reference Framing Type	$K_{Wframe}$
GWB-O	5.36
GWB-A	3.59

GWB-B	3.06
GWB-C	2.88
GWB-D	2.71
GWB-E	2.54
GWB-F	2.04
GWB-G	1.96
GWB-H	1.72
WSP-A	1.00
WSP-B	0.53
WSP-C	0.37
WSP-D	0.29
WSP-E	0.25
WSP-F	0.23
DWB	0.61

When wind acts on the building width, the length of the building (dimension parallel to the wind) is irrelevant to determining the bracing required to resist that wind force. A short building receives the same wind force as a long building with an equivalent width. This concept is illustrated in Figure A-9.23.13.7.(3)-A. As a result, in calculating the length of required wind bracing, the input is the braced wall band spacing (the building width), regardless of building length.

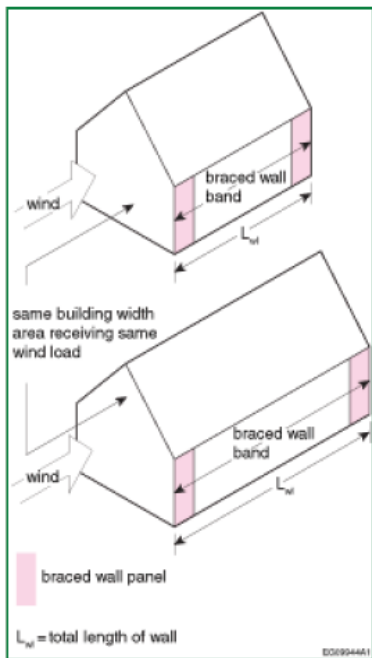
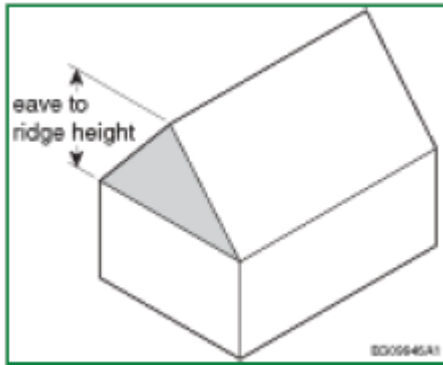


Figure A-9.23.13.7.(3)-A

#### Wind Force on Different Length Buildings

The equation provided in Sentence 9.23.13.7.(3) is used to calculate the required length of braced wall panels,  $L_w$ , within a braced wall band to resist wind acting on the surface perpendicular to the wall line. The unadjusted length,  $L_{uw}$ , provided in Table 9.23.13.7.-A, refers to a reference building with an eave-to-ridge height of 3 m and two exterior braced wall bands spaced 7.6 m apart, located in an urban location. Adjustment factors are applied to account for deviations from the reference building. These adjustment factors are explained below and their values are provided in Table 9.23.13.7.-B.



**Figure A-9.23.13.7.(3)-B**

**Eave-to-ridge Height**

$K_{roof}$  accounts for the effect of eave-to-ridge height, as defined in Figure A-9.23.13.7.(3)-B.

$K_{exp}$  adjusts for wind loading on a building caused by the effects of local terrain. Wind blows at a lower speed in rough terrain and a higher speed in smooth terrain. Rough terrain, such as an urban or suburban setting or wooded terrain extending upwind for a least one km, offers a comparatively sheltered exposure for a building. For rough terrain,  $K_{exp}$  is assigned the value 1.0 and no exposure adjustment is needed for a building located in rough terrain. A building located in an open terrain, sheltered from wind only by the presence of adjacent scattered trees and buildings or other obstacles, or located near open water or shorelines, will experience a higher wind load than would the same building located in rough terrain.

$K_{Wspacing}$  accounts for the change in lateral load resistance when the spacing between braced wall bands,  $X$ , differs from 7.6 m. When more than two braced wall bands resist lateral load, the increase in resistance is not directly proportional to the increase in the number of braced wall bands.

$K_{Wnumber}$  accounts for the distribution of forces when more than two braced wall bands resist wind load, Figure A-9.23.13.5.(3)-C. The same explanation in Note A-9.23.13.7.(4) for  $K_{Snumber}$  applies here for  $K_{Wnumber}$ , except that under wind load the forces are not evenly distributed due to the critical load case occurring when the wind blows at an angle to the building. As a result,  $K_{Wnumber}$  factor differs slightly from the  $K_{Snumber}$  factor. When the spacing of the parallel braced wall bands is not uniform, the average spacing value, as illustrated in Figure A-9.23.13.7.(3)-D, shall be used. Refer to  $K_{Snumber}$  for additional information.

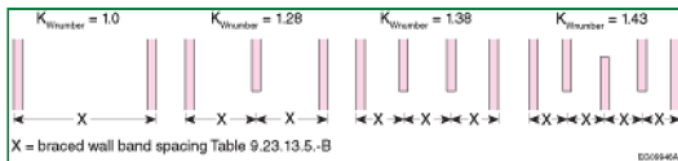


Figure A-9.23.13.7.(3)-C

Adjustment for number of braced wall bands resisting wind load

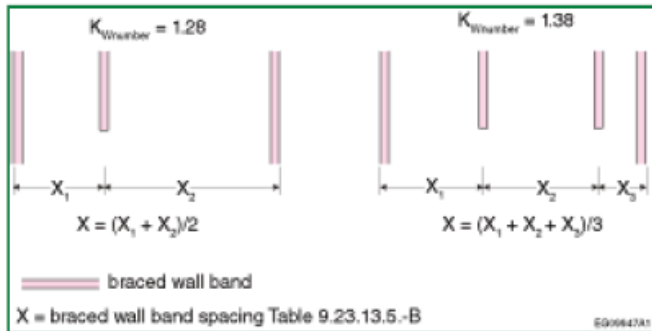


Figure A-9.23.13.7.(3)-D

Calculation of mean braced wall band spacing for wind when the spacings between adjacent braced wall bands are not uniform

Where the braced wall band is intermittently sheathed, the lengths of braced wall panels listed in Table 9.23.13.7.-A. shall be increased by the  $K_{\text{sheath}}$  factor. Braced wall bands with intermittent braced wall panels permit the use of nonstructural sheathing in areas of the wall where bracing is not required. This factor accounts for a lack of additional resistance otherwise provided by structural sheathing above and below openings and on other non-designated braced wall panels within the braced wall band (Figure A-9.23.13.7.(3)-E), as there would be when the entire braced wall line is continuously sheathed (Figure A-9.23.13.7.(3)-F).

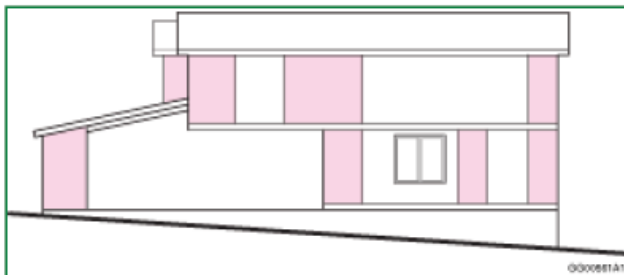
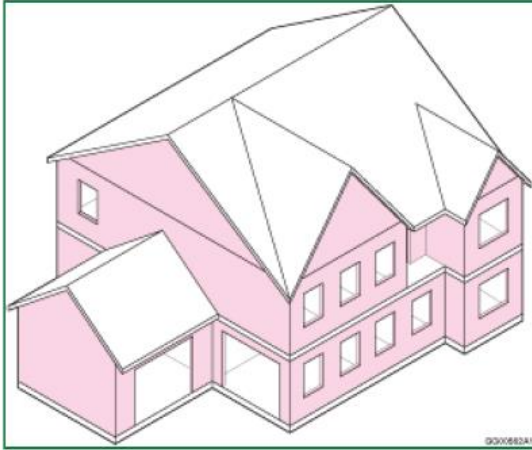


Figure A-9.23.13.7.(3)-E

Intermittent braced wall panels (Source: A guide to 2018 Wood Wall Bracing Provisions.)



**Figure A-9.23.13.7.(3)-F**

Continuously sheathed braced wall panels (default) (Source: A guide to 2018 Wood Wall Bracing Provisions.)

Non-designated wall segments within continuously-sheathed braced wall bands are required to be constructed with wood sheathing, but are not required to use the same sheathing and fastening as used in the designated braced wall panels along the braced wall band. Instead, the non-designated wall segments may be constructed with any of the plywood, OSB, or waferboard element options and corresponding fastening in accordance with Table 9.23.3.5.-A, and anchored in accordance with Sentence 9.23.6.1.(2). Note that when the calculated  $L_w$  exceeds the available length of the wall line, a stronger framing type or a closer braced wall band spacing may be considered.

**A-9.23.13.7.(4) Alternative Procedure to Calculate the Seismic-related Braced Wall Panel Length.** To facilitate calculations of prescribed braced wall panel lengths, the seismic-related minimum total unadjusted braced wall panel lengths,  $L_{us}$ , are provided in Table 9.23.13.7.-C for categories of the seismic design parameter,  $S_{max}$ . The values provided within each  $S_{max}$  category are based on the highest  $S_{max}$  in the category, and must be adjusted by the factors provided in Table 9.23.13.7.-D. In lieu of the method given in Sentence 9.23.13.7.(4), the adjusted braced wall panel length, the minimum required total braced wall length for seismic,  $L_s$ , is permitted to be calculated directly using the following equation:

$$L_s = (C_{sstorey} C_{walls} C_{roof} S) (K_{sframe} S_{max} K_{weight} K_{spacing} K_{number} K_{gyp} K_{sheath}) \geq BWP_{min}$$

where:

- $C_{sstorey}$  = coefficient of storey location, for seismic
  - = 1 for braced wall panels supporting roof only
  - = 3 for braced wall panels supporting roof + 1 floor
  - = 5 for braced wall panels supporting roof + 2 floors
- $C_{walls}$  = coefficient accounting for the seismic weight based on the depth of the building, for walls, given in Table A-9.23.13.7.(4)-A
- $C_{roof}$  = coefficient accounting for the seismic weight based on the depth of the building, for roof, given in Table A-9.23.13.7.(4)-A
- $S$  = specified roof snow load, kPa (See Article 9.4.2.2)
- $K_{sframe}$  = adjustment factor for framing type given in Table A-9.23.13.7.(4)-B



- $S_{max}$  = seismic design parameter, listed in Table 9.4.1.1
- $K_{weight}$  = weight of construction and cladding adjustment, for seismic  
= 1.0 for normal weight construction (See Sentence 9.23.13.2.(3))
- $K_{snow}$  = roof snow load adjustment, for seismic  
= 1.0 for 2 kPa roof snow load (as calculated in accordance with Article 9.4.2.2.)
- $K_{spacing}$  = braced wall band spacing adjustment for seismic per building plan direction (See Sentence 9.23.13.7.(5))  
= 1.0 for 7.6 m braced wall band spacing
- $K_{number}$  = number of braced wall bands adjustment for seismic per building plan direction  
= 1.0 for no intermediate braced wall bands between exterior walls
- $K_{gyp}$  = interior gypsum board adjustment
- $K_{sheath}$  = intermittent braced wall panels adjustment  
= 1.0 for continuously wood-sheathed braced wall bands
- $BWP_{min}$  = minimum length of individual braced wall panels as per Table 9.23.13.5.

**Table A-9.23.13.7.(3)-A**

**Seismic Related Coefficients,  $C_{walls}$  and  $C_{roof}$**

Building dimension parallel to braced wall band, m	$C_{walls}^{(1)}$	$C_{roof}$
3.1	0.38	0.09
6.1	0.60	0.17
9.1	0.83	0.26
12.2	1.06	0.35
15.5	1.29	0.43
18.3	1.52	0.52

Note to Table A-9.23.13.7.(4)-A :

<sup>(1)</sup> Linear interpolation is permitted

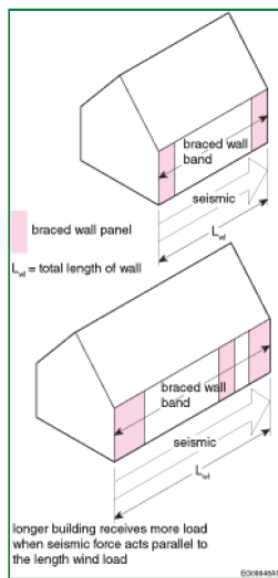
**Table A-9.23.13.7.(4)-B**

**Seismic Related Framing Adjustment Factor,  $K_{Sframe}$**

Reference Framing Type	$K_{Wframe}$
GWB-O	8.04
GWB-A	5.39
GWB-B	4.58
GWB-C	4.32
GWB-D	4.07
GWB-E	3.81
GWB-F	3.07
GWB-G	2.95

GWB-H	2.58
WSP-A	1.00
WSP-B	0.53
WSP-C	0.46
WSP-D	0.42
WSP-E	0.41
WSP-F	0.38
DWB	0.57

The force demand exerted on a building by seismic motion is directly proportional to the mass of the building. When determining the amount of bracing required to resist seismic forces, the length of the building parallel to the direction of loading is the most important consideration, because mass is generally evenly distributed along the length and width of a building. For a given building width, a longer building has more mass – and thus receives greater seismic forces – than a shorter building. As a result, the longer building requires a greater amount of bracing. For this reason, in the seismic bracing table, Table 9.23.13.7.-C, the amount of braced wall panel required in a wall line is dependent on the available building depth parallel to the braced wall band being considered, and is less dependent of the width of the building (perpendicular to the direction of the seismic force). This is illustrated in Figure A-9.23.13.7.(4)-A.



**Figure A-9.23.13.7.(4)-A**

#### **Seismic Force on Different Length Buildings**

The equation provided in Sentence 9.23.13.7.(4) is used to calculate the total required length of braced wall panels,  $L_s$ , within a braced wall band to resist seismic force applied in that direction. The unadjusted length,  $L_{us}$ , provided in Table 9.23.13.7.-C, refers to a reference building with an eave-to-ridge height of 3 m and two braced wall bands spaced 7.6 m apart, with a roof snow load of 2 kPa. Adjustment factors are applied to account for construction that deviates from the

reference building. The values of the adjustment factors are presented in Table 9.23.13.7.-D. The adjustment factors are explained below.

$K_{\text{snow}}$  accounts for specified roof snow load larger than 2 kPa.

$K_{\text{spacing}}$  accounts for the change in lateral load resistance when the spacing between braced wall bands differs from 7.6 m. When more than two braced wall bands resist lateral load, the increase in resistance is not directly proportional to the increase in the number of braced wall bands.

$K_{\text{number}}$  accounts for the distribution of forces when more than two braced wall bands resist seismic load, Figure A-9.23.13.7.(4)-B. At first glance, it may seem counter-intuitive for the factor to increase when there are additional braced wall bands. However, since the braced wall panel lengths are determined based on the braced wall band spacing, the factor is needed to account for the actual distributed loads. Consider a 15 m building with a uniform seismic load of 10 kN/m horizontally applied to the width of a building with two exterior braced wall bands and one interior braced wall band. Equally distributing the seismic load to the three braced wall bands results in an actual force distribution of  $(15 \text{ m} \times 10 \text{ kN/m}) / 3$  braced wall bands = 50 kN per braced wall band. However, based on the braced wall band spacing, each braced wall band would receive only  $(10 \text{ kN/m} \times 7.5 \text{ m braced wall band spacing}) / 2$  braced wall bands = 37.5 kN.  $K_{\text{number}}$  corrects the calculated braced wall panel length by applying, for 3 braced wall bands, a factor of  $50 \text{ kN} / 37.5 \text{ kN} = 1.33$ . Note that in this case,  $K_{\text{number}}$  is applied to the unadjusted braced wall panel length for a 7.5 m braced wall band spacing to obtain the total braced wall panel length for each of the three braced wall bands in the 15 m wide building. As the amount of braced wall bands increases, the effect diminishes, and therefore the highest  $K_{\text{number}}$  factor applied to 5 braced wall bands is also sufficient for more than 5 braced wall bands. When the spacing of the parallel braced wall bands is not uniform, the average spacing value, as illustrated in Figure A.9.23.13.7.(4)-C, may be used in lieu of the largest spacing.

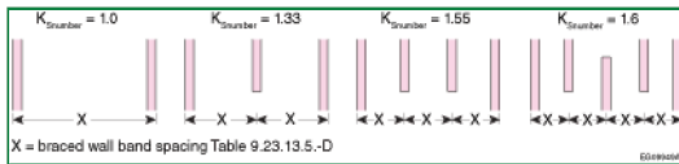


Figure A-9.23.13.7.(4)-B

#### Adjustment for Number of Braced Wall Bands Resisting Seismic Load

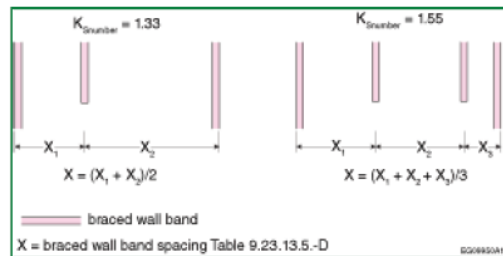
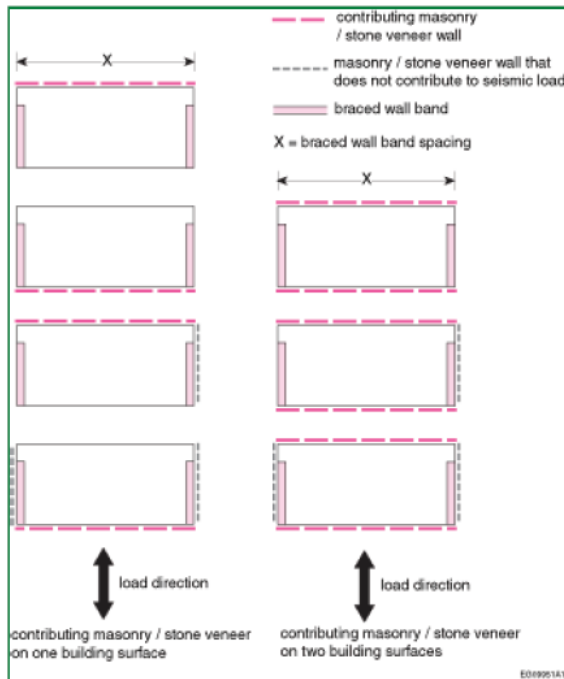


Figure A-9.23.13.7.(4)-C

#### Calculation of Mean Braced Wall Band Spacing for Seismic When the Spacings between Adjacent Braced Wall Bands are Not Uniform

As stated above, heavy buildings generate high seismic loads. For buildings that have construction weights higher than normal construction, the total length of braced wall panels

needs to be adjusted by the weight of construction factor,  $K_{weight}$ . The value of  $K_{weight}$  depends on whether the building is classified as heavy construction, or it is clad with masonry veneer or stone veneer on one or two building faces, as illustrated in Figure A-9.23.13.7.(4)-D. Note that in the case of masonry veneer or stone veneer clad buildings, only the veneer located on the building faces perpendicular to the direction of seismic load are assumed to contribute to the seismic mass.



**Figure A-9.23.13.7.(4)-D**

### **Masonry Veneer or Stone Veneer Walls that Contribute to Seismic Force Applied on a Building**

The minimum braced wall panel lengths provided in Table 9.23.13.7.-D assume that gypsum board is attached to the interior face of braced wall panels. If gypsum board is omitted, the braced wall panels are to be adjusted by the  $K_{gyp}$  factor.

Where the braced wall band is intermittently sheathed, the minimum lengths of braced wall panels listed in Table 9.23.13.7.-C must be increased by the  $K_{sheath}$  factor. Braced wall bands with intermittent braced wall panels permit the use of non-structural sheathing in areas of the wall where bracing is not required. This factor accounts for a lack of additional resistance otherwise provided by structural sheathing above and below openings and on other non-designated braced wall panels within the braced wall band (Figure A-9.23.13.7.(3)-E), as there would be when the entire braced wall band is continuously wood-sheathed (Figure A-9.23.13.7.(3)-F).

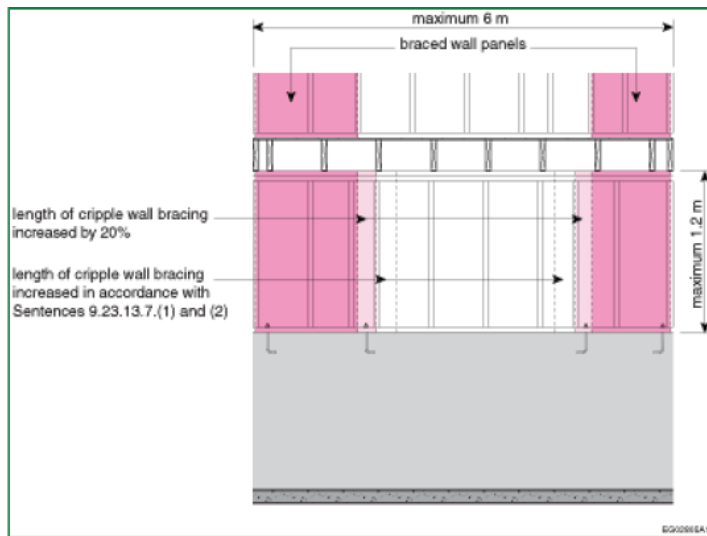
Non-designated wall segments within continuously-sheathed braced wall bands are required to be constructed with wood sheathing, but are not required to use the same sheathing and fastening as used in the designated braced wall panels along the braced wall band. Instead, the non-designated wall segments may be constructed with any of the plywood, OSB, or waferboard element options and corresponding fastening in accordance with Table 9.23.3.5.-A, and anchored in accordance with Sentence 9.23.6.1.(2).

The calculation procedure provided in this appendix note may be used to determine the minimum total required braced wall panel lengths for those cases designated as design required (DR) in Table 9.23.13.7.-C. Note that when the calculated  $L_s$  exceeds the available length of the wall line, a stronger framing type or a closer braced wall band spacing may be considered.

**A-9.23.13.8. Foundation Cripple Walls.** Cripple walls are also known as “pony walls” or “knee walls.” In Section 9.23., the term “cripple walls” refers to short wood-frame stud walls extending from the top of the foundation wall to the underside of the lowest floor framing.

Studies have demonstrated that wood-frame foundation walls with low racking resistance, such as unbraced or insufficiently braced cripple walls, do not have adequate capacity to resist seismic loading. Such walls have led to the failure of buildings in earthquakes. Where cripple walls do not meet the conditions of Sentences 9.23.13.8.(2) to (4), they need to be considered as an additional storey, or designed in accordance with Part 4 to ensure that they resist both in-plane and out-of-plane forces. Information on cripple walls can be found in the Commentary entitled Design for Seismic Effects in the “Structural Commentaries (User’s Guide – NBC 2020: Part 4 of Division B).”

**A-9.23.13.8.(2) Foundation Cripple Walls Where  $S_{max} \leq 0.60$  .**



**Figure A-9.23.13.8.(2)**

**Foundation cripple wall where  $S_{max} \leq 0.60$**

**A-9.23.13.8.(3). Foundation Cripple Walls Where  $S_{max} > 0.60$ .**

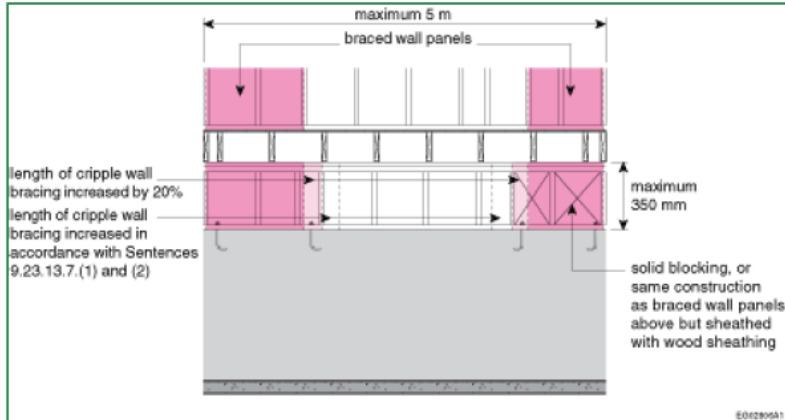


Figure A-9.23.13.8.(3)

**Foundation cripple wall where  $S_{max} > 0.60$**

**A-9.23.13.9.(1) Cripple Walls in Stepped Foundations.** The conditions of Sentence 9.23.13.9.(1) are intended to establish whether the stepped foundation provides sufficient bracing for the braced wall band it supports. If the bracing is not considered to be sufficient, the provisions of Sentences 9.23.13.8.(2) to (4) for the appropriate value of  $S_{max}$  apply.

Where the foundation is less than 2.4 m in length, the attachment to the foundation is insufficient to complete the lateral load path for the first-storey braced wall band. In this case, the cripple wall needs to be braced, and there is no need for the top plate to be anchored to the foundation, although it would be good practice.

Where the foundation is at least 2.4 m in length and the top plate of the cripple wall is adequately anchored to the foundation wall, the cripple wall itself does not need to be braced, provided its height does not exceed 1.2 m.

Where the cripple wall exceeds 1.2 m in height, it must be considered as a storey or designed in accordance with Part 4 (see Sentence 9.23.13.8.(1)), regardless of the adequacy of the bracing it provides.

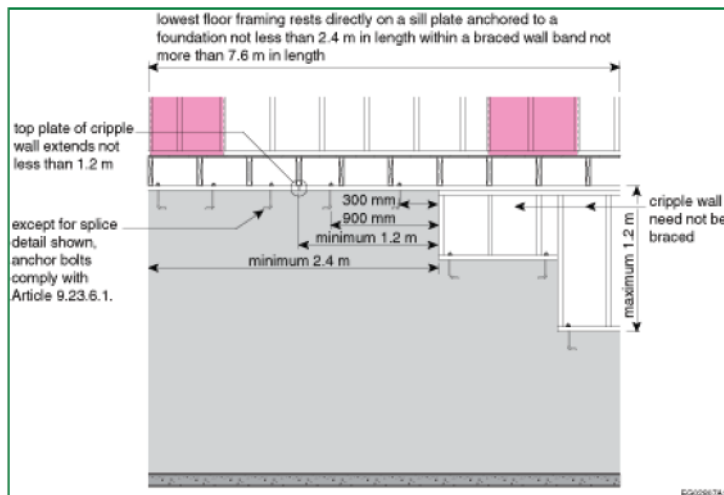


Figure A-9.23.13.9.(1)

**Cripple wall in a stepped foundation**

A-9.23.13.10.(2) Attachment of a Porch Roof to Exterior Wall Framing.

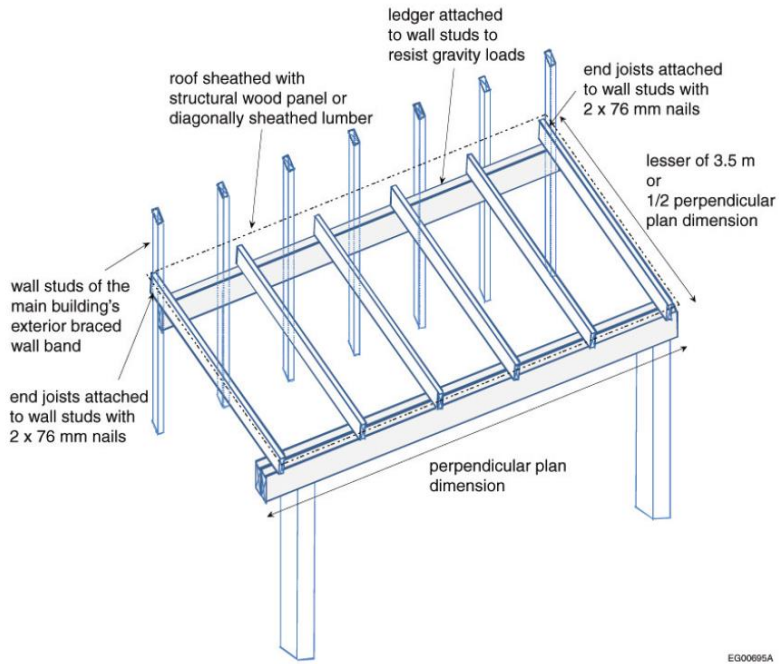


Figure A-9.23.13.10.(2)-A

Framing perpendicular to plane of wall (balloon construction)

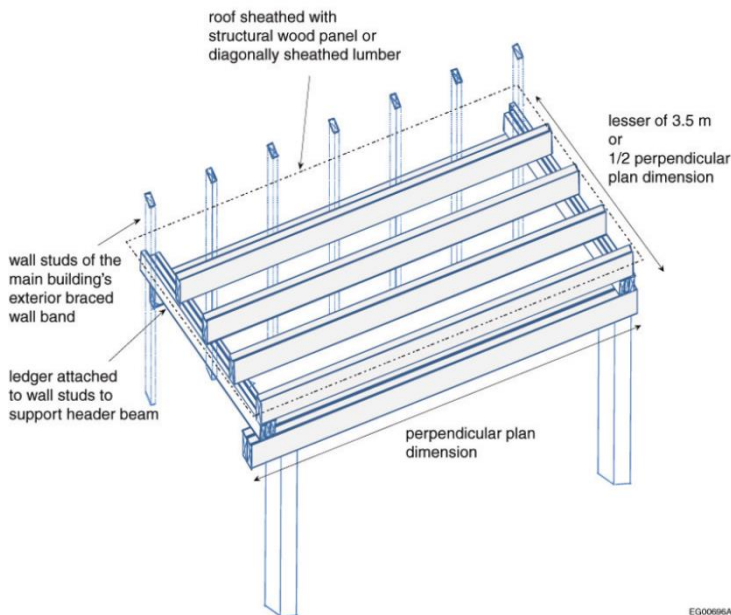


Figure A-9.23.13.10.(2)-B

Framing parallel to plane of wall

**A-9.23.14.11.(2) Wood Roof Truss Connections.** Sentence 9.23.14.11.(2) requires that the connections used in wood roof trusses be designed in conformance with Subsection 4.3.1. and Sentence 2.2.1.2.(1) of Division C, which applies to all of Part 4, requires that the designer be a professional engineer or architect skilled in the work concerned. This has the effect of requiring that the trusses themselves be designed by professional engineers or architects. Although this is a departure from the usual practice in Part 9, it is appropriate, since wood roof trusses are complex structures which depend on a number of components (chord members, web members, cross-bracing, connectors) working together to function safely. This complexity precludes the standardization of truss design into tables comprehensive enough to satisfy the variety of roof designs required by the housing industry.

**A-9.23.15.2.(4) Water Absorption Test.** A method for determining water absorption is described in ASTM D1037, "Standard Test Methods for Evaluating Properties of Wood-Base Fiber and Particle Panel Materials." The treatment to reduce water absorption may be considered to be acceptable if a 300 mm × 300 mm sample when treated on all sides and edges does not increase in weight by more than 6% when tested in the horizontal position.

**A-9.23.15.4.(2) OSB.** CSA O437.0, "OSB and Waferboard," requires that Type O (aligned or oriented) panels be marked to show the grade and the direction of face alignment.

**A-9.24.3.2.(3) Framing Above Doors in Steel Stud Fire Separations.**

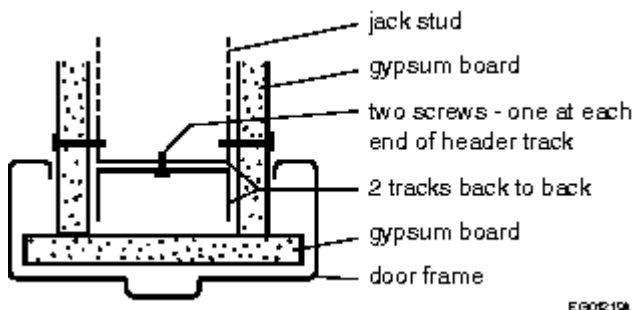


Figure A-9.24.3.2.(3)

#### Steel stud header detail

**A-9.25.1.1.(2) Difference Between a Vapour Barrier and an Air Barrier.** It is important to understand the difference between the functions of a vapour barrier and an air barrier. Some materials perform both functions, while others are only intended to perform one of the two.

Vapour barrier materials are intended to restrict the movement of water vapour due to vapour pressure differentials, which are created by differences in temperature and moisture content, while air barrier materials are intended to restrict the movement of air due to air pressure differentials.

A vapour barrier does not have to be continuous or sealed to perform its function of reducing the amount of water vapour that moves across an assembly, but an air barrier must be continuous and fully sealed to prevent the movement of air across the assembly.

Further information can be found in "The difference between a vapour barrier and an air barrier," by Quirouette, R. L., Building Performance Section, Division of Building Research, National Research Council Canada, BPN 54, July 1985.

**A-9.25.2.2.(2) Flame-Spread Ratings of Insulating Materials.** Part 9 has no requirements for flame-spread ratings of insulation materials since these are seldom exposed in parts of buildings



where fires are likely to start. Certain of the insulating material standards referenced in Sentence 9.25.2.2.(1) do include flame-spread rating criteria. These are included either because the industry producing the product wishes to demonstrate that their product does not constitute a fire hazard or because the product is regulated by authorities other than building authorities (e.g., "Hazardous Products Act" ). However, the Code cannot apply such requirements to some materials and not to others. Hence, these flame-spread rating requirements are excepted in referencing these standards.

**A-9.25.2.3.(3) Position of Insulation.** For thermal insulation to be effective, it must not be short-circuited by convective airflow through or around the material. If low-density fibrous insulation is installed with an air space on both sides of the insulation, the temperature differential between the warm and cold sides will drive convective airflow around the insulation. If foamed plastic insulation is spot-adhered to a backing wall or adhered in a grid pattern to an air-permeable substrate, and is not sealed at the joints and around the perimeter, air spaces between the insulation and the substrate will interconnect with spaces behind the cladding. Any temperature or air pressure differential across the insulation will again lead to short circuiting of the insulation by airflow. Thermal insulation must therefore be installed in full and continuous contact with the air barrier or another continuous component with low air permeance. (See Note A-9.25.5.1.(1) for examples of low-air-permeance materials.)

**A-9.25.2.4.(3) Loose-Fill Insulation in Existing Wood-Frame Walls.** The addition of insulation into exterior walls of existing wood-frame buildings increases the likelihood of damage to framing and cladding components as a result of moisture accumulation. Many older homes were constructed with little or no regard for protection from vapour transmission or air leakage from the interior. Adding thermal insulation will substantially reduce the temperature of the siding or sheathing in winter months, possibly leading to condensation of moisture at this location.

Defects in exterior cladding, flashing and caulking could result in rain entering the wall cavity. This moisture, if retained by the added insulation, could initiate the process of decay.

Steps should be taken therefore, to minimize these effects prior to the retrofit of any insulation. Any openings in walls that could permit leakage of interior heated air into the wall cavity should be sealed. The inside surface should be coated with a low-permeability paint to reduce moisture transfer by diffusion. Finally, the exterior siding, flashing and caulking should be checked and repaired if necessary to prevent rain penetration.

**A-9.25.2.4.(5) Loose-Fill Insulation in Masonry Walls.** Typical masonry cavity wall construction techniques do not lend themselves to the prevention of entry of rainwater into the wall space. For this reason, loose-fill insulation used in such space must be of the water repellent type. A test for water-repellency of loose-fill insulation suitable for installation in masonry cavity walls can be found in ASTM C516, "Standard Specification for Vermiculite Loose Fill Thermal Insulation."

**A-9.25.3.1.(1) Air Barrier Systems for Control of Condensation.** The majority of moisture problems resulting from condensation of water vapour in walls and ceiling/attic spaces are caused by the leakage of moist interior heated air into these spaces rather than by the diffusion of water vapour through the building envelope.

Protection against such air leakage must be provided by a system of air-impermeable materials joined with leak-free joints. Generally, air leakage protection can be provided by the use of air-impermeable sheet materials, such as gypsum board or polyethylene of sufficient thickness, when installed with appropriate structural support. However, the integrity of the airtight elements in the air barrier system can be compromised at the joints and here special care must be taken in design and construction to achieve an effective air barrier system.

Although Section 9.25. refers separately to vapour barriers and airtight elements in the air barrier system, these functions in a wall or ceiling assembly of conventional wood-frame construction are often combined as a single membrane that acts as a barrier against moisture diffusion and the movement of interior air into insulated wall or roof cavities. Openings cut through this membrane, such as for electrical boxes, provide opportunities for air leakage into concealed spaces, and special measures must be taken to make such openings as airtight as possible. Attention must also be paid to less obvious leakage paths, such as holes for electric wiring, plumbing installations, wall-ceiling and wall-floor intersections, and gaps created by shrinkage of framing members.

In any case, air leakage must be controlled to a level where the occurrence of condensation will be sufficiently rare, or the quantities accumulated sufficiently small, and drying sufficiently rapid, to avoid material deterioration and the growth of mould and fungi.

Generally the location in a building assembly of the airtight element of the air barrier system is not critical; it can restrict air leakage whether it is located near the outer surface of the assembly, near the inner surface or at some intermediate location. However, if a material chosen to act as an airtight element in the air barrier system also has the characteristics of a vapour barrier (i.e., low permeability to water vapour), its location must be chosen more carefully in order to avoid moisture problems. (See Notes A-9.25.5.1.(1) and A-9.25.4.3.(2).)

In some constructions, an airtight element in the air barrier system is the interior finish, such as gypsum board, which is sealed to framing members and adjacent components by gaskets, caulking, tape or other methods to complete the air barrier system. In such cases, special care in sealing joints in a separate vapour barrier is not critical. This approach often uses no separate vapour barrier but relies on appropriate paint coatings to give the interior finish sufficient resistance to water vapour diffusion that it can provide the required vapour diffusion protection.

The wording in Section 9.25. allows for such innovative techniques, as well as the more traditional approach of using a continuous sheet, such as polyethylene, to act as an “air/vapour barrier.”

Further information can be found in CBD 231, “Moisture problems in houses” (Canadian Building Digest 231), by A.T. Hansen, which is available from NRC.

**A-9.25.3.4. and 9.25.3.6. Air Leakage and Soil Gas Control in Floors-on-ground.** The requirement in Sentence 9.25.3.3.(6) regarding the sealing of penetrations of the air barrier also applies to hollow metal and masonry columns penetrating the floor slab. Not only the perimeters but also the centres of such columns must be sealed or blocked.

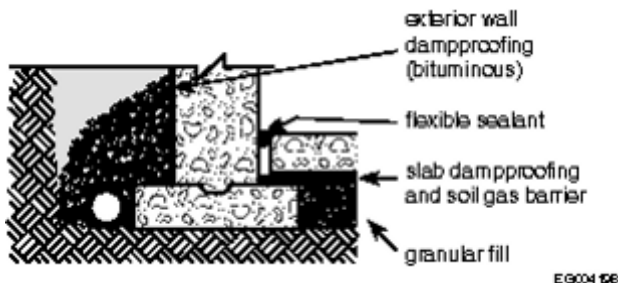


Figure A-9.25.3.4. and 9.25.3.6.-A

#### Dampproofing and soil gas control at foundation wall/floor junctions with solid walls

The requirement in Sentence 9.25.3.6.(6) regarding drainage openings in slabs can be satisfied with any of a number of proprietary devices that prevent the entry of radon and other soil gases

through floor drains. Some types of floor drains incorporate a trap that is connected to a nearby tap so that the trap is filled every time the tap is used. This is intended to prevent the entry of sewer gas but would be equally effective against the entry of radon and other soil gases.

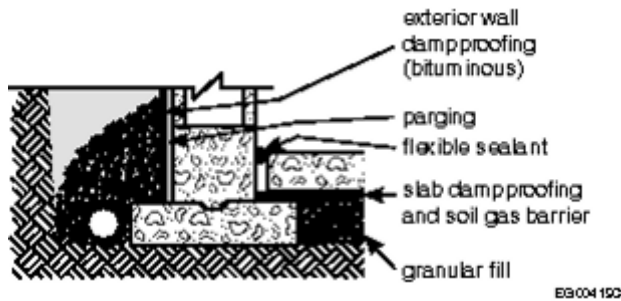


Figure A-9.25.3.4. and 9.25.3.6.-B

### Dampproofing and soil gas control at foundation wall/floor junctions with hollow walls

**A-9.25.3.6.(2) and (3) Polyethylene Air Barriers under Floors-on-Ground.** Floors-on-ground separating conditioned space from the ground must be constructed to reduce the potential for the entry of air, radon or other soil gases. In most cases, this will be accomplished by placing 0.15 mm polyethylene under the floor.

Finishing a concrete slab placed directly on polyethylene can, in many cases, cause problems for the inexperienced finisher. A rule of finishing, whether concrete is placed on polyethylene or not, is to never finish or "work" the surface of the slab while bleed water is present or before all the bleed water has risen to the surface and evaporated. If finishing operations are performed before all the bleed water has risen and evaporated, surface defects such as blisters, crazing, scaling and dusting can result. In the case of slabs placed directly on polyethylene, the amount of bleed water that may rise to the surface and the time required for it to do so are increased compared to a slab placed on a compacted granular base. Because of the polyethylene, the excess water in the mix from the bottom portion of the slab cannot bleed downward and out of the slab and be absorbed into the granular material below. Therefore, all bleed water, including that from the bottom of the slab, must now rise through the slab to the surface. Quite often in such cases, finishing operations are begun too soon and surface defects result.

One solution that is often suggested is to place a layer of sand between the polyethylene and the concrete. However, this is not an acceptable solution for the following reason: it is unlikely that the polyethylene will survive the slab pouring process entirely intact. Nevertheless, the polyethylene will still be effective in retarding the flow of soil gas if it is in intimate contact with the concrete; soil gas will only be able to penetrate where a break in the polyethylene coincides with a crack in the concrete. The majority of concrete cracks will probably be underlain by intact polyethylene. On the other hand, if there is an intervening layer of a porous medium, such as sand, soil gas will be able to travel laterally from a break in the polyethylene to the nearest crack in the concrete and the total system will be much less resistant to soil gas penetration.

To reduce and/or control the cracking of concrete slabs, it is necessary to understand the nature and causes of volume changes of concrete and in particular those relating to drying shrinkage. The total amount of water in a mix is by far the largest contributor to the amount of drying shrinkage and resulting potential cracking that may be expected from a given concrete. The less total amount of water in the mix, the less volume change (due to evaporation of water), which means the less drying shrinkage that will occur. To lessen the volume change and potential cracking due to drying shrinkage, a mix with the lowest total amount of water that is practicable should always be used. To lower the water content of a mix, superplasticizers are often added to

provide the needed workability of the concrete during the placing operation. Concretes with a high water-to-cementing-materials ratio usually have high water content mixes. They should be avoided to minimize drying shrinkage and cracking of the slab. The water-to-cementing-materials ratio for slabs-on-ground should be no higher than 0.55.

**A-9.25.4.2.(2) Vapour Barrier Materials in Foundation Wall Assemblies Enclosing Basements or Heated Crawl Spaces.** In the summer, solar heating can cause condensation to form on the wall-facing side of polyethylene membranes that are installed on the warm side of foundation wall assemblies enclosing a basement or heated crawl space. Moisture in the foundation wall due to wind-driven rain is driven to the interior when the above-ground portion of the wall is exposed to solar heating. Variable-permeance vapour barrier materials allow moisture to dissipate into the basement or heated crawl space during the summer and have thus been shown to minimize the formation of condensation in foundation wall assemblies. These materials have proven effective whether installed continuously over the full area of the foundation wall or continuously over not less than the top half of the full height of the wall area, starting from the above-ground portion, with a polyethylene membrane installed over the remaining bottom portion.

Sentence 9.25.4.2.(2) is not intended to preclude the use of variable-permeance vapour barriers in above-grade wall assemblies. However, when contemplating their use in such an application, consideration should be given to the climatic conditions at the building's location.

**A-9.25.4.2.(3) Normal Conditions.** The requirement for a  $60 \text{ ng}/(\text{Pa}\times\text{s}\times\text{m}^2)$  vapour barrier stated in Sentence 9.25.4.2.(1) is based on the assumption that the building assembly is subjected to conditions that are considered normal for typical residential occupancies, and business and personal services occupancies.

However, where the intended use of an occupancy includes facilities or activities that will generate a substantial amount of moisture indoors during the heating season, such as swimming pools, greenhouses, laundromats, and any continuous operation of hot tubs and saunas, the building envelope assemblies would have to demonstrate acceptable performance levels in accordance with the requirements in Part 5.

**A-9.25.4.2.(6) Protection of Vapour Barriers.** The requirements of CAN/CGSB-51.33-M, "Vapour Barrier Sheet, Excluding Polyethylene, for Use in Building Construction," were developed for paper-based vapour barriers, which are not susceptible to deterioration under prolonged exposure to direct ultraviolet (UV) radiation. Since the publication of the last edition of this standard in 1989, non-polyethylene vapour barriers have become available that are susceptible to UV-induced deterioration. These vapour barriers must be protected by a covering or installed in locations where they will not be exposed to direct UV radiation after the completion of construction. In addition, the vapour barrier manufacturer's guidance regarding the maximum allowable time of exposure to direct UV radiation should be followed where provided. Exposure to direct UV radiation most commonly occurs around window openings.

**A-9.25.4.3.(2) Location of Vapour Barriers.** Assemblies in which the vapour barrier is located partway through the insulation meet the intent of this Article provided it can be shown that the temperature of the vapour barrier will not fall below the dew point of the heated interior air.

#### **A-9.25.5.1. Location of Low Permeance Materials.**

##### **Low Air- and Vapour-Permeance Materials and Implications for Moisture Accumulation**

The location in a building assembly of a material with low air permeance is generally not critical; the material can restrict outward movement of indoor air whether it is located near the outer surface of the assembly, near the inner surface, or at some intermediate location, and such restriction of air movement is generally beneficial, whether or not the particular material is

designated as part of the air barrier system. However, if such a material also has the characteristics of a vapour barrier (i.e. low permeability to water vapour), its location must be chosen more carefully in order to avoid moisture accumulation.

Any moisture from the indoor air that diffuses through the inner layers of the assembly or is carried by air leakage through those layers may be prevented from diffusing or being transferred through the assembly by a low air- and vapour-permeance material. This moisture transfer will usually not cause a problem if the material is located where the temperature is above the dew point of the indoor air: the water vapour will remain as vapour, the humidity level in the assembly will come to equilibrium with that of the indoor air, further accumulation of moisture will cease or stabilize at a low rate, and no harm will be done.

But if the low air- and vapour-permeance material is located where the temperature is below the dew point of the air at that location, water vapour will condense and accumulate as water or ice, which will reduce the humidity level and encourage the movement of more water vapour into the assembly. If the temperature remains below the dew point for any length of time, significant moisture could accumulate. When warmer weather returns, the presence of a material with low water vapour permeance can retard drying of the accumulated moisture. Moisture that remains into warmer weather can support the growth of decay organisms.

Due consideration should be given to the properties and location of any material in the building envelope, including paints, liquid-applied or sprayed-on and trowelled-on materials. It is recognized that constructions that include low air- and vapour-permeance materials are acceptable, but only where these materials are not susceptible to damage from moisture or where they can accommodate moisture, for example insulated concrete walls. Further information on the construction of basement walls can be found in "Performance Guidelines for Basement Envelope Systems and Materials," published by NRC.

### Cladding

Different cladding materials have different vapour permeances and different degrees of susceptibility to moisture deterioration. They are each installed in different ways that are more or less conducive to the release of moisture that may accumulate on the inner surface. Sheet or panel-type cladding materials, such as metal sheet, have a vapour permeance less than  $60 \text{ ng}/(\text{Pa}\times\text{s}\times\text{m}^2)$ . Sheet metal cladding that has lock seams also has a low air leakage characteristic and so must be installed outboard of a drained and vented air space. Assemblies clad with standard residential vinyl or metal strip siding do not require additional protection as the joints are not so tight as to prevent the dissipation of moisture.

### Sheathing

Like cladding, sheathing materials have different vapour permeances and different degrees of susceptibility to moisture deterioration.

Low-permeance sheathing may serve as the vapour barrier if it can be shown that the temperature of the interior surface of the sheathing will not fall below that at which saturation will occur. This may be the case where insulating sheathing is used.

### Thermal Insulation

Where low-permeance foamed plastic is the sole thermal insulation in a building assembly, the temperature of the inner surface of this element will be close to the interior temperature. If the foamed plastic insulation has a permeance below  $60 \text{ ng}/(\text{Pa}\times\text{s}\times\text{m}^2)$ , it can fulfill the function of a vapour barrier to control condensation within the assembly due to vapour diffusion. However, where low-permeance thermal insulating sheathing is installed on the outside of an insulated frame wall, the temperature of the inner surface of the insulating sheathing may fall below the

dew point; in this case, the function of vapour barrier has to be provided by a separate building element installed on the warm side of the assembly.

#### Normal Conditions

The required minimum ratios given in Table 9.25.5.2. are based on the assumption that the building assembly is subjected to conditions that are considered normal for typical residential occupancies, and business and personal services occupancies.

However, where the intended use of an occupancy includes facilities or activities that will generate a substantial amount of moisture indoors during the heating season, such as swimming pools, greenhouses, the operation of a laundromat or any continuous operation of hot tubs and saunas, the building envelope assemblies would have to demonstrate acceptable performance levels in accordance with the requirements in Part 5.

**A-9.25.5.1.(1) Air and Vapour Permeance Values.** The air leakage characteristics and water vapour permeance values for a number of common materials are given in Table A-9.25.5.1.(1). These values are provided on a generic basis; proprietary products may have values differing somewhat from those in the Table (consult the manufacturers' current data sheets for their products' values).

The values quoted are for the material thickness listed. Water vapour permeance is inversely proportional to thickness: therefore, greater thicknesses will have lower water vapour permeance values.

**Table A-9.25.5.1.(1)**  
**Air and Vapour Permeance Values<sup>(1)</sup>**

Material	Air Leakage Characteristic, L/(s×m²) at 75 Pa (Air Permeance)	Water Vapour Permeance, (Dry Cup) ng/(Pa×s×m²)
Sheet and panel-type materials		
12.7-mm gypsum board	0.02	2600
• painted (1 coat primer)	negligible	1300
• painted (1 coat primer + 2 coats latex paint)	negligible	180
12.7-mm foil-backed gypsum board	negligible	negligible
12.7-mm gypsum board sheathing	0.0091	1373
6.4-mm plywood	0.0084	23 – 74
11-mm oriented strandboard	0.0108	44 (range)
12.5-mm cement board	0.147	590
plywood (from 9.5 mm to 18 mm)	negligible – 0.01	40 – 57
fibreboard sheathing	0.012 – 1.91	100 – 2900
17-mm wood sheathing	high – depends on no. of joints	982
Insulation		
27-mm foil-faced polyisocyanurate	negligible	4.3
27-mm paper-faced polyisocyanurate	negligible	61.1
25-mm extruded polystyrene	negligible	23 – 92
25-mm expanded polystyrene (Type 2)	0.0214	86 – 160
fibrous insulations	very high	very high

25-mm polyurethane spray foam – low density	0.011	894 – 3791
25-mm polyurethane spray foam – medium density	negligible	96 <sup>(2)</sup>
Membrane-type materials		
asphalt-impregnated paper (10 min paper)	0.0673	370
asphalt-impregnated paper (30 min paper)	0.4	650
asphalt-impregnated paper (60 min paper)	0.44	1800
water-resistive barriers (9 materials)	negligible – 4.3	30 – 1200
0.15-mm polyethylene	negligible	1.6 – 5.8
asphalt-saturated felt (#15)	0.153	290
building paper	0.2706	170 – 1400
spun-bonded polyolefin film (expanded)	0.9593	3646
Other materials		
brick (6 materials)	negligible	102 – 602
metal	negligible	negligible
mortar mixes (4 materials)	negligible	13 – 690
stucco	negligible	75 – 240
50-mm reinforced concrete (density: 2 330 kg/m <sup>3</sup> )	negligible	23

**Notes to Table A-9.25.5.1.(1):**

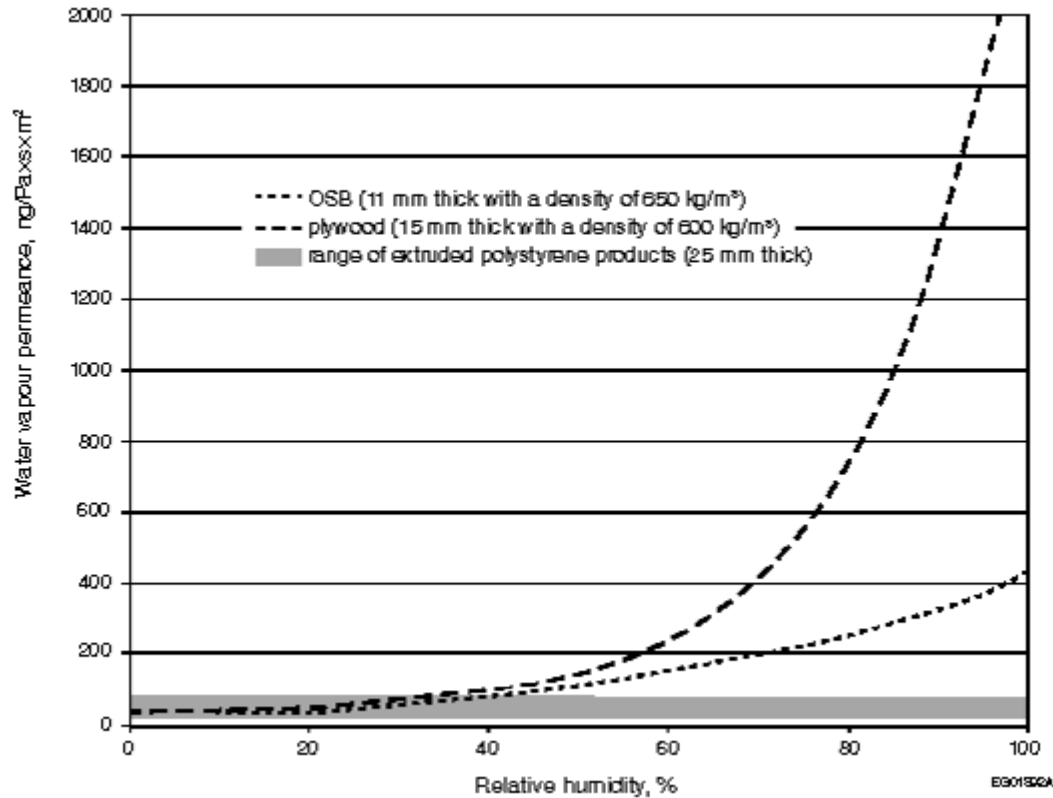
<sup>(1)</sup> Air leakage and vapour permeance values derived from:

- Bombaru, D., Jutras, R. and Patenaude, A. “Air Permeance of Building Materials.” Summary Report prepared by AIR-INS Inc. for Canada Mortgage and Housing Corporation, Ottawa, 1988. Values indicate properties of tested materials only; values for specific products may vary significantly.
- “Details of Air Barrier Systems for Houses.” Taron Warranty Corporation (formerly Ontario New Home Warranty Program), Toronto, 1993.
- Kumaran, M.K., et al., ASHRAE Research Report 1018 RP, A Thermal and Moisture Transport Property Database for Common Building and Insulating Materials.
- Kumaran, M.K., Lackey, J., Normandin, N., van Reenen, D., Tariku, F., Summary Report from Task 3 of MEWS Project at the Institute for Research in Construction-Hygrothermal Properties of Several Building Materials, IRC-RR-110, March 2002.
- Mukhopadhyaya, P., Kumaran, M.K., et al., Hygrothermal Properties of Exterior Claddings, Sheathings Boards, Membranes and Insulation Materials for Building Envelope Design, Proceedings of Thermal Performance of the Exterior Envelopes of Whole Building X, Clearwater, Florida, December 2-7, 2007, pp. 1-16 (NRCC-50287).

<sup>(2)</sup> This water vapour permeance value is for a 25-mm-thick core layer of medium-density polyurethane spray foam. When installed in the field, a low permeance resin layer forms where the foam is in contact with the substrate. The water vapour permeance of the installed foam, were it measured including the resin layer, would therefore likely be lower than the value listed in the Table.

**A-9.25.5.1.(1)(a)(ii) Reduced Potential for Condensation in the Building Envelope.** The requirements in Article 9.25.5.2. aim to reduce the risk of condensation being introduced into wall assemblies due to the water vapour permeance of the outboard materials. Research has confirmed that the reduced condensation potential of exterior continuous insulation with a thermal resistance of at least 0.7 (m<sup>2</sup>×K)/W and a water vapour permeance between 30 and 1 800 ng/(Pa×s×m<sup>2</sup>) compares to reference assemblies without exterior insulation in a given geographic location and climatic exposure.

**A-9.25.5.1.(3) Wood-based Sheathing Materials.** Wood-based sheathing materials, such as plywood and OSB, that are not more than 12.5 mm thick are exempt from complying with Sentence 9.25.5.1.(1) because wood has an adaptive vapour permeance based on relative humidity: it has a low vapour permeance in an environment with low relative humidity and a higher vapour permeance in an environment with high relative humidity (see Figure A-9.25.5.1.(3)).



**Figure A-9.25.5.1.(3)**

**Adaptive water vapour permeance of wood-based sheathing materials**

This adaptive vapour permeance means that wood-based materials located on the outboard side of an assembly in winter, where the RH is typically 75% or higher, are relatively vapour-open, thus allowing greater vapour movement. The same wood-based material located on the inboard side of an assembly, where the RH is typically much lower in winter, has a low vapour permeance, thus mitigating the movement of vapour.

**A-9.25.5.2. Assumptions Followed in Developing Table 9.25.5.2.** Article 9.25.5.2. specifies that a low air- and vapour-permeance material must be located on the warm face of the assembly, outboard of a vented air space, or within the assembly at a position where its inner surface is likely to be warm enough for most of the heating season such that no significant accumulation of moisture will occur. This last position is defined by the ratio of the thermal resistance values outboard and inboard of the innermost impermeable surface of the material in question.

The design values given in Table 9.25.5.2. are based on the assumption that the building includes a mechanical ventilation system (between 0.3 and 0.5 air changes per hour), a 60 ng/(Pa·s·m²) vapour barrier, and an air barrier (values between 0.024 and 0.1 L/sm² through the assembly



were used). The moisture generated by occupants and their use of bathrooms, cleaning, laundry and kitchen appliances was assumed to fall between 7.5 and 11.5 L per day.

It has been demonstrated through modeling under these conditions that assemblies constructed according to the requirements in Table 9.25.5.2. do not lead to moisture accumulation levels that may lead to deterioration as long as the average monthly vapour pressure difference between the exterior and interior sides over the heating season does not increase above 750 Pa, which would translate into an interior relative humidity of 35% in colder climates and 60% in mild climates.

Health Canada recommends an indoor relative humidity between 35% and 50% for healthy conditions. ASHRAE accepts a 30% to 60% range. Environments that are much drier tend to exacerbate respiratory problems and allergies; more humid environments tend to support the spread of microbes, moulds and dust mites, which can adversely affect health.

In most of Canada in the winter, indoor RH is limited by the exterior temperature and the corresponding temperature on the inside of windows. During colder periods, indoor RH higher than 35% will cause significant condensation on windows. When this occurs, occupants are likely to increase the ventilation to remove excess moisture. Although indoor RH may exceed 35% for short periods when the outside temperature is warmer, the criteria provided in Table 9.25.5.2. will still apply. Where higher relative humidities are maintained for extended periods in these colder climates, the ratios listed in the Table may not provide adequate protection. Some occupancies require that RH be maintained above 35% throughout the year, and some interior spaces support activities such as swimming that create high relative humidities. In these cases, Table 9.25.5.2. cannot be used and the position of the materials must be determined according to Part 5.

It should be noted that Part 9 building envelopes in regions with colder winters have historically performed acceptably when the interior RH does not exceed 35% over most of the heating season. With tighter building envelopes, it is possible to raise interior RH levels above 35%. There is no information, however, on how

Part 9 building envelopes will perform when exposed to these higher indoor RH levels for extended periods during the heating season over many years. Operation of the ventilation system, as intended to remove indoor pollutants, will maintain the lower RH levels as necessary.

### **Calculating Inboard to Outboard Thermal Resistance**

The method of calculating the inboard to outboard thermal resistance ratio is illustrated in Figure A-9.25.5.2. The example wall section shows three planes where low air- and vapour-permeance materials have been installed. A vapour barrier, installed to meet the requirements of Subsection 9.25.4., is on the warm side of the insulation consistent with Clause 9.25.5.2.(1)(a) and Sentences 9.25.4.1.(1) and 9.25.4.3.(2). The vinyl siding has an integral drained and vented air space consistent with Clause 9.25.5.2.(1)(c). The position of the interior face of the low-permeance insulating sheathing, however, must be reviewed in terms of its thermal resistance relative to the overall thermal resistance of the wall, and the climate where the building is located.

Comparing the RSI ratio from the example wall section with those in Table 9.25.5.2. indicates that this wall would be acceptable in areas with Celsius degree-day values up to 7999, which includes, for example, Whitehorse, Fort McMurray, Yorkton, Flin Flon, Geraldton, Val-d'Or and Wabush. (Degree-day values for various locations in Canada are provided in Appendix C.)

A similar calculation would indicate that, for a similar assembly with a 140 mm stud cavity filled with an RSI 3.52 batt, the ratio would be 0.28. Thus such a wall could be used in areas with Celsius degree-day values up to 4999, which includes, for example, Cranbrook, Lethbridge, Ottawa, Montreal, Fredericton, Sydney, Charlottetown and St. John's.

Similarly, if half the thickness of the same low-permeance sheathing were used, the ratio with an 89 mm cavity would be 0.25, permitting its use in areas with Celsius degree-day values up to 4999. The ratio with a 140 mm cavity would be 0.16; thus this assembly could not be used anywhere, since this ratio is below the minimum permitted in Table 9.25.5.2.

Table A-9.25.5.2. shows the minimum thicknesses of low-permeance insulating sheathing necessary to satisfy Article 9.25.5.2. in various degree-day zones for a range of resistivity values of insulating sheathing. These thicknesses are based on the detail shown in Figure A-9.25.5.2. but could also be used with cladding details, such as brick veneer or wood siding, which provide equal or greater outboard thermal resistance.

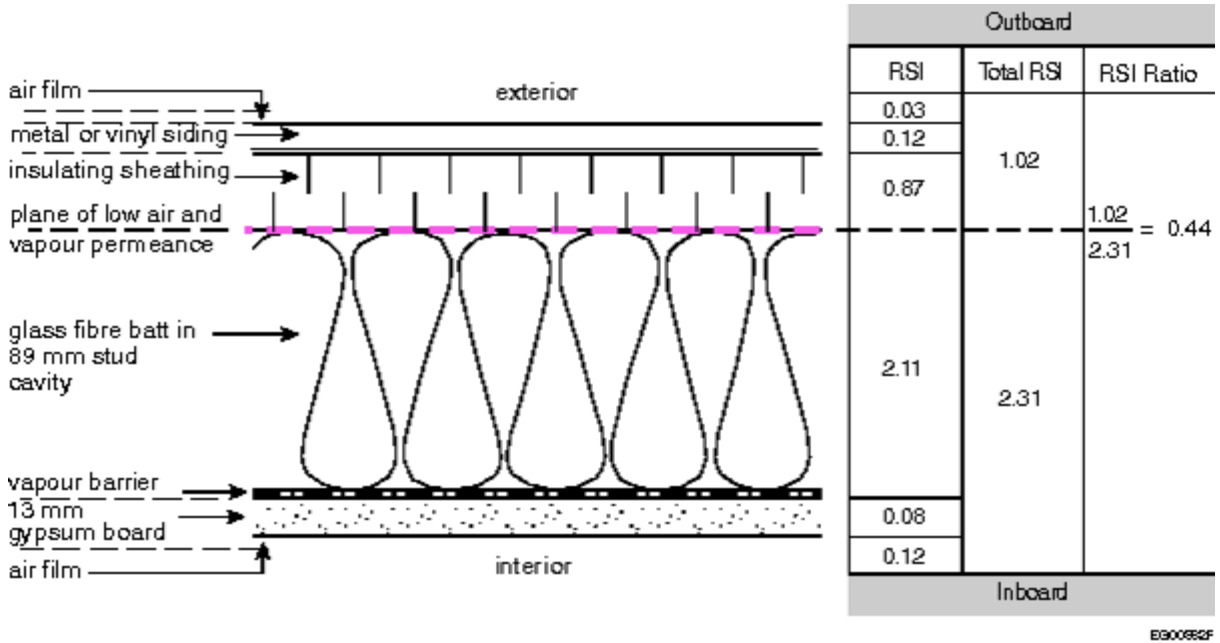


Figure A-9.25.5.2.

Example of a wall section showing thermal resistance inboard and outboard of a plane of low air and vapour permeance

Table A-9.25.5.2.

Minimum Thicknesses of Low-Permeance Insulating Sheathing											
Celsius Heating Degree-days	Min. RSI Ratio	38 × 89 Framing				38 × 140 Framing					
		Min. Outboard Thermal Resistance, RSI	Min. Sheathing Thickness, mm				Min. Outboard Thermal Resistance, RSI	Min. Sheathing Thickness, mm			
			Sheathing Thermal Resistance, RSI/mm					Sheathing Thermal Resistance, RSI/mm			
			0.0300	0.0325	0.0350	0.0400		0.0300	0.0325	0.0350	0.0400
≤ 4999	0.20	0.46	10	10	9	8	0.72	19	17	16	14
5000 to 5999	0.30	0.69	18	17	16	14	1.07	31	28	26	23

6000 to 6999	0.35	0.81	22	20	19	16	1.25	37	34	32	28
7000 to 7999	0.40	0.92	26	24	22	19	1.43	43	39	37	32
8000 to 8999	0.50	1.16	34	31	29	25	1.79	55	50	47	41
9000 to 9999	0.55	1.27	37	34	32	28	1.97	61	56	52	45
10000 to 10999	0.60	1.39	41	38	35	31	2.15	67	61	57	50
11000 to 11999	0.65	1.50	45	42	39	34	2.33	73	67	62	54
≥ 12000	0.75	1.73	53	49	45	40	2.69	85	78	72	63

## References

(1) "Exposure Guidelines for Residential Indoor Air Quality," Environmental Health Directorate, Health Protection Branch, Health Canada, Ottawa, April 1987 (Revised July 1989).

(2) ANSI/ASHRAE 62, "Ventilation for Acceptable Indoor Air Quality."

**A-9.26.1.1.(1) Platforms that Effectively Serve as Roofs.** Decks, balconies, exterior walkways and similar exterior surfaces effectively serve as roofs where these platforms do not permit the free drainage of water through the deck. When water is driven by wind across the deck (roof) surface, it can be driven upward when it encounters an interruption.

**A-9.26.2.3.(4) Fasteners for Treated Shingles.** Where shingles or shakes have been chemically treated with a preservative or a fire retardant, the fastener should be of a material known to be compatible with the chemicals used in the treatment.

**A-9.26.4.1. Junctions between Roofs and Walls or Guards.** Drainage of water from decks and other platforms that effectively serve as roofs will be blocked by walls, and blocked or restricted by guards where significant lengths and heights of material are connected to the deck. Without proper flashing at such roof-wall junctions or roof-guard junctions, water will generally leak into the adjoining constructions and can penetrate into supporting constructions below. Exceptions include platforms where waterproof curbs of sufficient height are cast-in or where the deck and wall or guard are unit-formed. In these cases, the monolithic deck-wall or deck-guard junctions will minimize the likelihood of water ingress. (See also Note A-9.26.1.1.(1).)

**A-9.26.17.1.(1) Installation of Concrete Roof Tiles.** Where concrete roof tiles are to be installed, the dead load imposed by this material should be considered in determining the minimum sizes and maximum spans of the supporting roof members.

**A-9.26.18.3.(1) Overflow Outlets.** Where a roof or balcony is entirely enclosed by parapet walls there is a likelihood of drains becoming obstructed with materials such as leaves falling during heavy autumn rains. It is recommended that a secondary means of drainage such as scuppers be provided. Overflow outlets should be installed in the parapet walls in sufficient number and at

an appropriate height to drain the roof or balcony, to avoid water backing up into moisture sensitive assemblies, and to prevent structural collapse from ponding.

**A-9.27.1.1.(5) EIFS on Walls with Cold-Formed Steel Stud Framing.** While Part 9 permits the installation of exterior insulation finish systems on walls with cold-formed steel stud framing, the design of loadbearing steel walls is outside the scope of Part 9 and is addressed in Part 4 (see Sentence 9.24.1.1.(2)).

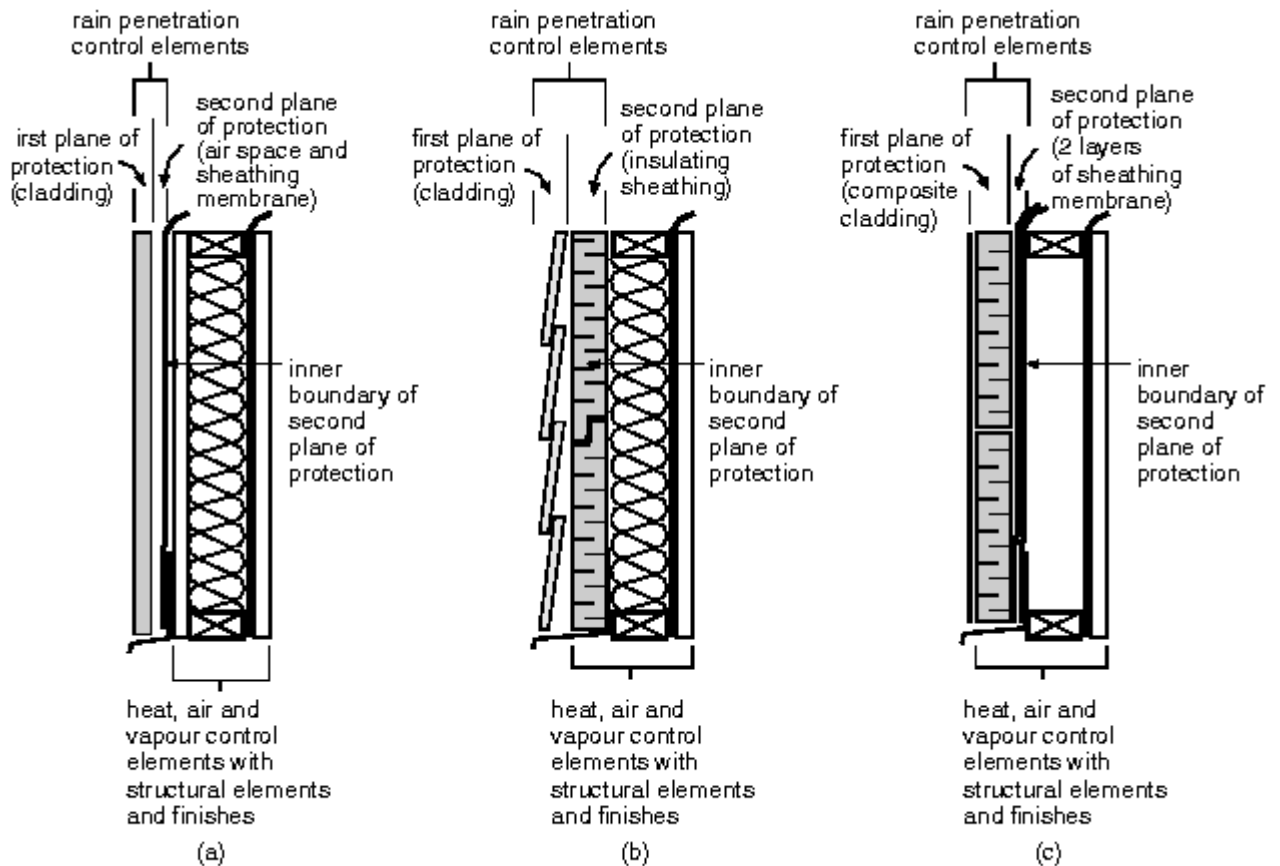
**A-9.27.2. Required Protection from Precipitation.** Part 5 and Part 9 of the Building By-law recognize that mass walls and face-sealed, concealed barrier and rainscreen assemblies have their place in the Canadian context.

Mass walls are generally constructed of cast-in-place concrete or masonry. Without cladding or surface finish, they can be exposed to precipitation for a significant period before moisture will penetrate from the exterior to the interior. The critical characteristics of these walls are related to thickness, mass, and moisture transfer properties, such as shedding, absorption and moisture diffusivity.

Face-sealed assemblies have only a single plane of protection. Sealant installed between cladding elements and other envelope components is part of the air barrier system and is exposed to the weather. Face-sealed assemblies are appropriate where it can be demonstrated that they will provide acceptable performance with respect to the health and safety of the occupants, the operation of building services and the provision of conditions suitable for the intended occupancy. These assemblies, however, require more intensive, regular and ongoing maintenance, and should only be selected on the basis of life-cycle costing considering the risk of failure and all implications should failure occur. Climate loads such as wind-driven rain, for example, should be considered. Face-sealed assemblies are not recommended where the building owner may not be aware of the maintenance issue or where regular maintenance may be problematic.

Concealed barrier assemblies include both a first and second plane of protection. The first plane comprises the cladding, which is intended to handle the majority of the precipitation load. The second plane of protection is intended to handle any water that penetrates the cladding plane. It allows for the dissipation of this water, primarily by gravity drainage, and provides a barrier to further ingress.

Like concealed barrier assemblies, rainscreen assemblies include both a first and second plane of protection. The first plane comprises the cladding, which is designed and constructed to handle virtually all of the precipitation load. The second plane of protection is designed and constructed to handle only very small quantities of incidental water; composition of the second plane is described in Note A-9.27.3.1. In these assemblies, the air barrier system, which plays a role in controlling precipitation ingress due to air pressure difference, is protected from the elements. (See Figure A-9.27.2.)



EG0260A

**Figure A-9.27.2.**

**Generic rainscreen assemblies**

The cladding assembly described in Sentence 9.27.2.2.(4) is a basic rainscreen assembly. This approach is required for residential buildings where a higher level of ongoing performance is expected without significant maintenance. This approach, however, is recommended in all cases.

The cladding assemblies described in Sentence 9.27.2.2.(5) are also rainscreen assemblies. The assembly described in Clause 9.27.2.2.(1)(c) is again a basic rainscreen assembly. A wall with a capillary break as described in Clause 9.27.2.2.(1)(a) is an open rainscreen assembly. Walls with a capillary break as described in Clause 9.27.2.2.(1)(b) have been referred to as drainscreen assemblies.

**A-9.27.2.1.(1) Minimizing Precipitation Ingress.** The total prevention of precipitation ingress into wall assemblies is difficult to achieve and, depending on the wall design and construction, may not be absolutely necessary. The amount of moisture that enters a wall, and the frequency with which this occurs, must be limited. The occurrence of ingress must be sufficiently rare, accumulation sufficiently small and drying sufficiently rapid to prevent the deterioration of moisture-susceptible materials and the growth of fungi.

**A-9.27.2.2. Required Levels of Protection from Precipitation.** Precursors to Part 9 and all editions of the Building By-law containing a Part 9 applying to housing and small buildings included a performance-based provision requiring that cladding provide protection from the weather for inboard materials. Industry requested that Part 9 provide additional guidance to assist in determining the minimum levels of protection from precipitation to be provided by

cladding assemblies. As with all requirements in the Building By-law, the new requirements in Article 9.27.2.2. describe the minimum cladding assembly configuration. Designers must still consider local accepted good practice, demonstrated performance and the specific conditions to which a particular wall will be exposed when designing or selecting a cladding assembly.

### **Capillary Breaks**

The properties that are necessary for a material or assembly to provide a capillary break, and quantitative values for those properties, have not been defined. Among the material properties that need to be addressed are water absorption and susceptibility to moisture-related deterioration. Among the assembly characteristics to be considered are bridging of spaces by water droplets, venting and drainage.

Clause 9.27.2.2.(1)(a) describes the capillary break configuration typical of open rainscreen construction. The minimum 10 mm will avoid bridging of the space by water droplets and allow some construction tolerance.

Clause 9.27.2.2.(1)(b) describes a variation on the typical open rainscreen configuration. Products used to provide the capillary break include a variety of non-moisture-susceptible, open-mesh materials.

Clause 9.27.2.2.(1)(c) describes a configuration that is typical of that provided by horizontal vinyl and metal siding, without contoured insulating backing. The air space behind the cladding components and the loose installation reduce the likelihood of moisture becoming trapped and promote drying by airflow.

Clause 9.27.2.2.(1)(d) recognizes the demonstrated performance of masonry cavity walls and masonry veneer walls.

### **Moisture Index**

The moisture index (MI) for a particular location reflects both the wetting and drying characteristics of the climate and depends on

- annual rainfall, and
- the temperature and relative humidity of the outdoor ambient air.

MI values are derived from detailed research and calculations.

Due to a lack of definitive data, the MI values identified in Sentence 9.27.2.2.(5), which trigger exceptions to or additional precipitation protection, are based on expert opinion. Designers should consider local experience and demonstrated performance when selecting materials and assemblies for protection from precipitation. For further information on MI, see Appendix C.

A-9.27.3.1. Second Plane of Protection. As specified in Sentence 9.27.3.1.(1), the second plane of protection consists of a drainage plane with an appropriate material serving as the inner boundary and flashing to dissipate rainwater or meltwater to the exterior.

### **Drainage Plane**

Except for masonry walls, the simplest configuration of a drainage plane is merely a vertical interface between materials that will allow gravity to draw the moisture down to the flashing to allow it to dissipate to the exterior. It does not necessarily need to be constructed as a clear drainage space (air space).

For masonry walls, an open rainscreen assembly is required; that is, an assembly with first and second planes of protection where the drainage plane is constructed as a drained and vented air space. Such construction also constitutes best practice for walls other than masonry walls.

Section 9.20. requires drainage spaces of 25 mm for masonry veneer walls and 50 mm for cavity walls. In other than masonry walls, the drainage space in an open rainscreen assembly should be at least 10 mm deep. Drainage holes must be designed in conjunction with the flashing.

### **Sheathing Membrane**

The sheathing membrane described in Article 9.27.3.2. is not a waterproof material. When installed to serve as the inner boundary of the second plane of protection, and when that plane of protection includes a drainage space at least 9.5 mm deep, the performance of the identified sheathing membrane has been demonstrated to be adequate. This is because the material is expected to have to handle only a very small quantity of water that penetrates the first plane of protection.

If the 9.5 mm drainage space is reduced or interrupted, the drainage capacity and the capillary break provided by the space will be reduced. In these cases, the material selected to serve as the inner boundary may need to be upgraded to provide greater water resistance in order to protect moisture-susceptible materials in the backing wall.

### **Appropriate Level of Protection**

It is recognized that many cladding assemblies with no space or with discontinuous space behind the cladding, and with the sheathing membrane material identified in Article 9.27.3.2., have provided acceptable performance with a range of precipitation loads imposed on them. Vinyl and metal strip siding, and shake and shingle cladding, for example, are installed with discontinuous drained spaces, and have demonstrated acceptable performance in most conditions. Lapped wood and composite strip sidings, depending on their profiles, may or may not provide discontinuous spaces, and generally provide little drainage. Cladding assemblies with limited drainage capability that use a sheathing membrane meeting the minimum requirements are not recommended where they may be exposed to high precipitation loads or where the level of protection provided by the cladding is unknown or questionable. Local practice with demonstrated performance should be considered. (See also Article 9.27.2.2. and Note A-9.27.2.2.)

**A-9.27.3.4.(2) Detailing of Joints in Exterior Insulating Sheathing.** The shape of a joint is critical to its ability to shed water. Tongue and groove, and lapped joints can shed water if oriented correctly. Butt joints can drain to either side and so should not be used unless they are sealed. However, detailing of joints requires attention not just to the shape of the joint but also to the materials that form the joint. For example, even if properly shaped, the joints in insulating sheathing with an integral sheathing membrane could not be expected to shed water if the insulating material absorbs water, unless the membrane extends through the joints.

**A-9.27.3.5.(1) Sheathing Membranes in lieu of Sheathing.** Article 9.23.17.1. indicates that sheathing must be installed only where the cladding requires intermediate fastening between supports (studs) or where the cladding requires a solid backing. Cladding such as brick or panels would be exempt from this requirement and in these cases a double layer of sheathing membrane would generally be needed. The exception (Article 9.27.3.6.) applies only to those types of cladding that provide a face seal to the weather.

**A-9.27.3.6. Sheathing Membrane under Face Sealed Cladding.** The purpose of sheathing membrane on walls is to reduce air infiltration and to control the entry of wind-driven rain. Certain types of cladding consisting of very large sheets or panels with well-sealed joints will perform this function, eliminating the need for sheathing membrane. This is true of the metal cladding with lock-seamed joints sometimes used on mobile homes. However, it does not apply to metal or plastic siding applied in narrow strips which is intended to simulate the appearance of lapped wood siding. Such material does not act as a substitute for sheathing membrane since it

incorporates provision for venting the wall cavity and has many loosely-fitted joints which cannot be counted on to prevent the entry of wind and rain.

Furthermore, certain types of sheathing systems can perform the function of the sheathing membrane. Where it can be demonstrated that a sheathing material is at least as impervious to air and water penetration as sheathing membrane and that its jointing system results in joints that are at least as impervious to air and water penetration as the material itself, sheathing membrane may be omitted.

#### A-9.27.3.8.(1) Required Flashing.

##### Horizontal Offsets

Where a horizontal offset in the cladding is provided by a single cladding element, there is no joint between the offset and the cladding above. In this case, and provided the cladding material on the offset provides effective protection for the construction below, flashing is not required.

##### Changes in Substrate

In certain situations, flashing should be installed at a change of substrate: for example, where stucco cladding is installed on a wood-frame assembly, extending down over a masonry or cast-in-place concrete foundation and applied directly to it. Such an application does not take into account the potential for shrinkage of the wood frame and cuts off the drainage route for moisture that may accumulate behind the stucco on the frame construction.

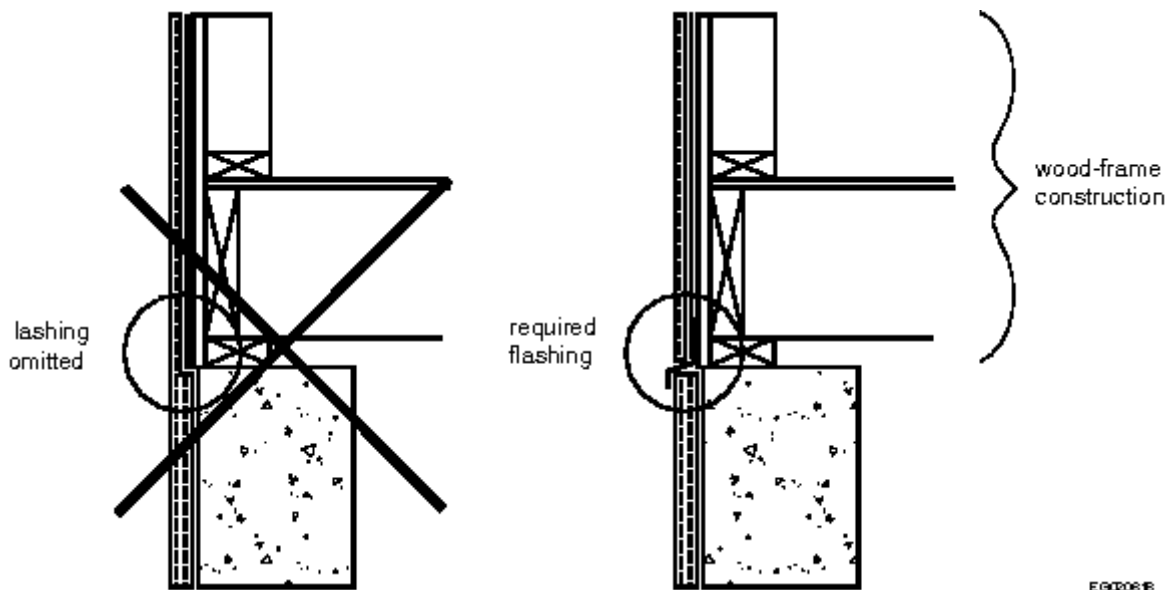


Figure A-9.27.3.8.(1)

##### Flashing at change in substrate

A-9.27.3.8.(3) Flashing over Curved-Head Openings. The requirement for flashing over openings depends on the vertical distance from the top of the trim over the opening to the bottom of the eave compared to the horizontal projection of the eave. In the case of curved-head openings, the vertical distance from the top of the trim increases as one moves away from the centre of the opening. For these openings, the top of the trim must be taken as the lowest height before the trim becomes vertical. (See Figure A-9.27.3.8.(3).)



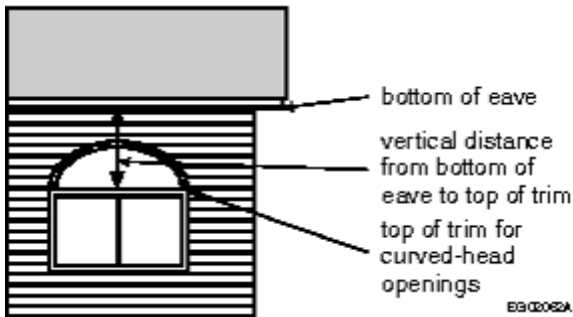


Figure A-9.27.3.8.(3)

**Flashing over curved-head openings**

A-9.27.3.8.(4) Flashing Configuration and Positive Drainage.

**Flashing Configuration**

A 6% slope is recognized as the minimum that will provide effective flashing drainage. The 10 mm vertical lap over the building element below and the 5 mm offset are prescribed to reduce transfer by capillarity and surface tension. Figure A-9.27.3.8.(4) illustrates two examples of flashing configurations.

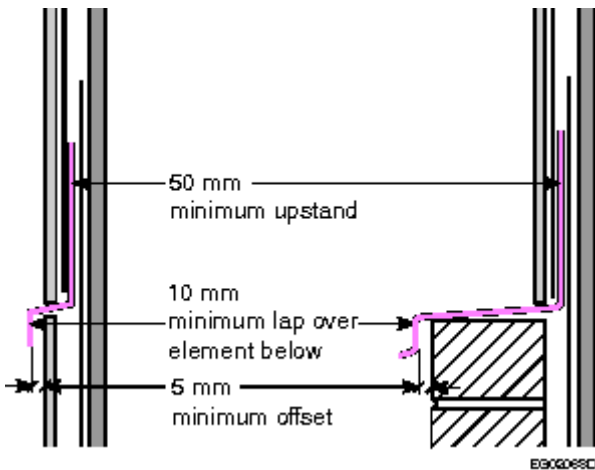


Figure A-9.27.3.8.(4)

**Examples of flashing configurations showing upstands, horizontal offsets and vertical laps**

**Maintaining Positive Slope**

Sentence 9.27.3.8.(4) requires that the minimum 6% flashing slope remain after expected shrinkage of the building frame. Similarly, Sentence 9.26.3.1.(4) requires that a positive slope remain on roofs and similar constructions after expected shrinkage of the building frame.

For Part 9 wood-frame constructions, expected wood shrinkage can be determined based on the average equilibrium moisture content (MC) of wood, within the building envelope assembly, in various regions of the City (see Table A-9.27.3.8.(4)).

**Table A-9.27.3.8.(4)**

**Equilibrium Moisture Content for Wood**

Regions	Equilibrium MC, % <sup>(1)</sup>
---------	----------------------------------

British Columbia and Atlantic Canada	10
Ontario and Quebec	8
Prairies and the North	7

**Notes to Table A-9.27.3.8.(4):**

<sup>(1)</sup> CWC 2000, "Wood Reference Handbook."

For three-storey constructions to which Part 9 applies, cumulative longitudinal shrinkage is negligible. Shrinkage need only be calculated for horizontal framing members using the following formula (from CWC 1997, "Introduction to Wood Building Technology" ):

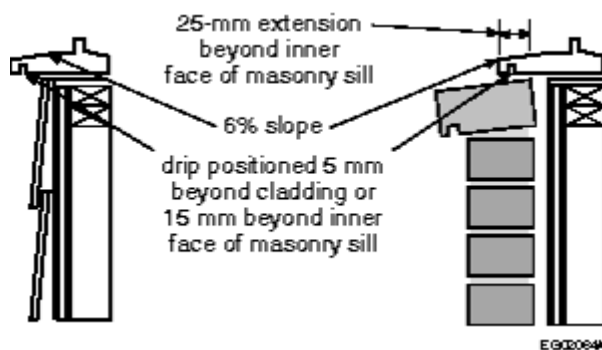
$$\text{Shrinkage} = (\text{total horizontal member height}) \times (\text{initial MC} - \text{equilibrium MC}) \times (.002)$$

**A-9.27.3.8.(5) Protection against Precipitation Ingress at the Sill-to-Cladding Joint.** Many windows are configured in such a way that a line of sealant is the only protection against water ingress at the sill-to-cladding joint—a location that is exposed to all of the water that flows down the window. In the past, many windows were constructed with self-flashing sills—sills that extend beyond the face of the cladding and have a drip on the underside to divert water away from the sill-to-cladding joint. This sill configuration was considered to be accepted good practice and is recognized today as providing a degree of redundancy in precipitation protection.

Self-flashing sills are sills that

- slope toward the exterior where the sills have an upward facing surface that extends beyond the jambs,
- where installed over a masonry sill, extend not less than 25 mm beyond the inner face of that sill,
- incorporate a drip positioned not less than 5 mm outward from the outer face of the cladding below or not less than 15 mm beyond the inner edge of a masonry sill, and
- terminate at the jambs or, where the face of the jambs is not at least flush with the face of the cladding and the sills extend beyond the jambs, incorporate end dams sufficiently high to protect against overflow in wind-driven rain conditions.

A wind pressure of 10 Pa can raise water 1 mm. Thus, for example, if a window is exposed to a driving rain wind pressure of 200 Pa, end dams should be at least 20 mm high.



**Figure A-9.27.3.8.(5)**

**Examples of configurations of self-flashing sills**

**A-9.27.4.2.(1) Selection and Installation of Sealants.** Analysis of many sealant joint failures indicates that the majority of failures can be attributed to improper joint preparation and deficient installation of the sealant and various joint components. The following ASTM

guidelines describe several aspects that should be considered when applying sealants in unprotected environments to achieve a durable application:

- ASTM C1193, “Standard Specification for Use of Joint Sealants,”
- ASTM C1299, “Standard Guide for Use in Selection of Liquid-Applied Sealants,” and
- ASTM C1472, “Standard Guide for Calculating Movement and Other Effects When Establishing Sealant Joint Width.”

The sealant manufacturer's literature should always be consulted for recommended procedures and materials.

**A-9.27.5.4.(2) Attachment of Cladding to Flat Wall ICF Units where the 1-in-50 HWP Exceeds 0.60 kPa.** For locations where the 1-in-50 hourly wind pressure is greater than 0.60 kPa, the results of testing fasteners to ASTM D1761, “Standard Test Methods for Mechanical Fasteners in Wood and Wood-Based Materials,” must be obtained from a testing facility or from the insulating concrete form manufacturer to confirm their ultimate strengths for both direct withdrawal and lateral shear. In accordance with limit states design as described in Subsection 4.1.3., the factored resistances of the fastener must be equal to or greater than the factored loads on the fastener at the spacing proposed by the designer. In order to align with the limit states design procedures used to develop Table 9.27.5.4.-B, the factored resistances must be calculated by applying a reduction factor of  $\Phi = 0.35$  to the fastener's ultimate strengths, and the factored loads must lie within the area under the line of linear interaction in a diagram that plots the factored lateral shear resistance of the fastener against its factored direct withdrawal resistance.

**A-9.27.5.7. Penetration of Fasteners.** Where cladding is applied to sheathing that is not suitable for fastening, the fastener length must be increased to maintain the minimum fastener penetration depth into the nail-holding base substrate, as specified in Article 9.27.5.7.

**A-9.27.9.2.(2) Grooves in Hardboard Cladding.** Grooves deeper than that specified may be used in thicker cladding, provided they do not reduce the thickness to less than the required thickness minus 1.5 mm.

**A-9.27.10.2.(2) Thickness of Grade O-2 OSB.** In using Table 9.27.8.2. to determine the thickness of Grade O-2 OSB cladding, substitute “face orientation” for “face grain” in the column headings.

**A-9.27.11.1.(1) Steel Sheet Products.** The minimum thickness of 0.33 mm stated in Sentence 9.27.11.1.(1) refers to the total thickness of the materials, i.e., the combination of the minimum thickness of the base steel (0.29 mm) and the minimum coating thickness required by CSSBI 23M, “Standard for Residential Steel Cladding.” Note that the terms “siding” and “cladding” are often used interchangeably.

**A-9.27.11.1.(2) and (3) Material Standards for Aluminum Cladding.** Compliance with Sentence 9.27.11.1.(2) and CAN/CGSB-93.2-M, “Prefinished Aluminum Siding, Soffits, and Fascia, for Residential Use,” is required for aluminum siding that is installed in horizontal or vertical strips. Compliance with Sentence 9.27.11.1.(3) and CAN/CGSB-93.1-M, “Sheet, Aluminum Alloy, Prefinished, Residential,” is required for aluminum cladding that is installed in large sheets.

**A-9.27.14.1.(1) Geometrically Defined Drainage Cavity.** “Geometrically defined drainage cavity” (GDDC) refers to the channels, grooves or profiles cut into the insulation backing of an EIFS panel for the purpose of providing a way for water that gets behind the system to drain out. The channels, grooves or profiles of one panel need to connect to the channels, grooves or profiles of adjacent panels in order for drainage to occur consistently and uniformly across the entire EIFS. While the size of a channel, groove or profile can be verified by inspecting a single

panel, the intent of Sentence 9.27.14.1.(1) is that the required drainage capacity be achieved across the entire system.

Additional information on the design and installation of EIFS can be found in

- the “EIFS Practice Manual,” published by the EIFS Council of Canada, and
- the manufacturer's literature.

A-9.27.14.2.(2)(a) Substrates for Exterior Insulation Finish Systems. The list of acceptable substrates for each type of EIFS can be found in a system's respective test report to CAN/ULC-S716.1, “Standard for Exterior Insulation and Finish Systems (EIFS) - Materials and Systems” ; however, the following substrates are generally considered acceptable:

- minimum 11 mm thick exposure 1 OSB classified as PS2 exterior wall sheathing
- minimum 11 mm thick exterior-rated plywood sheathing
- minimum 12.7 mm thick exterior gypsum sheathing conforming to ASTM C1177/C1177M, “Standard Specification for Glass Mat Gypsum Substrate for Use as Sheathing”
- cementitious panels
- fibre-cement panels
- concrete block
- clay masonry
- cast-in-place concrete

Note that, in some cases, the list of acceptable substrates may be limited by the EIFS manufacturer.

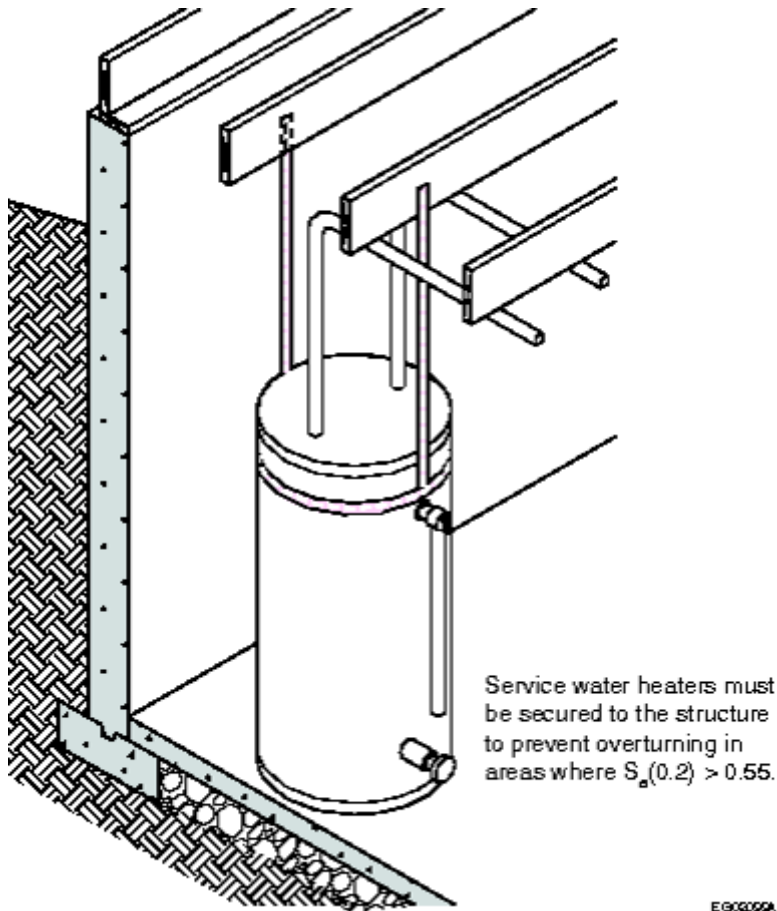
**A-Table 9.28.4.3. Stucco Lath.** Paper-backed welded wire lath may also be used on horizontal surfaces provided its characteristics are suitable for such application.

**A-9.29.5.1.(3) Application of Gypsum Board to Flat ICF Walls.** ASTM C840, “Standard Specification for Application and Finishing of Gypsum Board,” specifies requirements for the anchorage of gypsum board panels to flat wall ICF units in the section on System XVI. While the standard practice for the application of gypsum board panels over traditional vertical wood studs or metal framing members is to align the vertical joints of the panels on a supporting member, ASTM C840 requires that the vertical joints between the panels be positioned halfway between the web fastening strips of the flat wall ICF units to minimize damage to the edges of the panels during screw anchorage. The full surface of the flat wall ICF insulation panels (backed by the concrete cores) provides solid, continuous support of the taped gypsum board panel joints, which protects them from potential deflection, cracking and impact damage.

A-9.30.1.2.(1) Water Resistance. In some areas of buildings, water and other substances may frequently be splashed or spilled onto the floor. It is preferable, in such areas, that the finish flooring be a type that will not absorb moisture or permit it to pass through; otherwise, both the flooring itself and the subfloor beneath it may deteriorate. Also, particularly in food preparation areas and bathrooms, unsanitary conditions may be created by the absorbed moisture. Where absorbent or permeable flooring materials are used in these areas, they should be installed in such a way that they can be conveniently removed periodically for cleaning or replacement, i.e., they should not be glued or nailed down. Also, if the subfloor is a type that is susceptible to moisture damage (this includes virtually all of the wood-based subfloor materials used in wood-frame construction), it should be protected by an impermeable membrane placed between the finish flooring and the subfloor. The minimum degree of impermeability required by

Sentence 9.30.1.2.(1) would be provided by such materials as polyethylene, aluminum foil, and most single-ply roofing membranes (EPDM, PVC).

**A-9.31.6.2.(3) Securement of Service Water Heaters.**



**Figure A-9.31.6.2.(3)**

**Securement of service water heater using strapping fastened to floor joists overhead**

**Seismic Bracing of Hot Water Tank**

“Guidelines for Earthquake Bracing of Residential Water Heaters” is available from the California Office of the State Architect and provides more detail and alternate methods of bracing hot water tanks to resist earthquakes.

**A-9.32.1.2.(2) Application of Subsection 9.32.3. and Ventilation of Houses Containing a Secondary Suite.**

**Ventilation for Smoke Control**

The control of smoke transfer between dwelling units in a house with a secondary suite, or between the dwelling units and other spaces in the house, is a critical safety issue. Although providing a second ventilation system to serve the two dwelling units is expensive – and potentially difficult in an existing building – it is an ideal solution for achieving a minimum acceptable level of fire safety.

Other solutions to providing separate ventilation systems for the dwelling units must address smoke control. Although smoke dampers restrict the spread of smoke by automatically closing in the event of a fire, their installation in a ventilation system that serves both dwelling units in a house with a secondary suite is not considered to be an ideal solution because they are very expensive, require regular inspection and maintenance, and must be reset after every activation.

### **Ventilation for Air Exchange**

The provision of a ventilation system for the purpose of maintaining acceptable indoor air quality is a critical health issue. However, Sentence 9.32.1.2.(3) allows exits and public corridors in houses with a secondary suite to be unventilated. Lack of active ventilation of these spaces is considered acceptable because occupants do not spend long periods of time there and because exits are somewhat naturally ventilated when doors are opened.

Considering the cost of installing separate ventilation systems, Sentence 9.32.1.2.(4) also exempts ancillary spaces in houses with a secondary suite from the requirement to be ventilated, provided that make-up air is supplied in accordance with Article 9.32.3.4.

**A-9.32.1.3.(2) Venting of Laundry-Drying Equipment.** Sentence 9.32.1.3.(2) applies to the piping and ducting located within the wall assembly and not to the often flexible duct used to connect the appliance to the rigid exhaust vent duct.

**A-9.32.3. Heating-Season Mechanical Ventilation.** While ventilation strategies can have a significant impact on energy performance, ventilation is primarily a health and safety issue. Inadequate ventilation can lead to mold, high concentrations of CO<sub>2</sub>, and other indoor air pollutants, which can lead to adverse health outcomes. Previous editions of the Building By-law relied on ventilation through the building envelope in combination with a principal exhaust fan. However, with the increased attention on the continuity of the air barrier system in buildings, builders can no longer rely on uncontrolled ventilation through the building envelope. In most buildings, mechanical systems will be required to provide adequate ventilation for occupants.

As described in Article 9.32.3.3., every dwelling unit must include a principal ventilation system. A principal ventilation system is the combination of an exhaust fan and a supply fan (or passive supply in some instances: see Sentence 9.32.3.4.(6)).

The principal ventilation system exhaust fan is separate from the requirements for a fan in every bathroom and kitchen. While a bathroom fan may be used to satisfy both the requirements for the principal ventilation exhaust fan and the requirements for a bathroom fan, the requirements for each must be met. If the fan provides this combined function of the principal ventilation exhaust fan and the bathroom fan, it will also need to have controls that conform to Sentences 9.32.3.5.(3) and (4). Unlike other bathroom fans, the principal ventilation exhaust fan is required to run continuously and should not have a control switch in a location where it may be turned off inadvertently.

#### **A-9.32.3.1.(1) Required Ventilation.**

##### **Performance Approach [Clause 9.32.3.1.(1)(a)]**

CAN/CSA-F326-M, "Residential Mechanical Ventilation Systems," is a comprehensive performance standard. It gives experienced ventilation system designers the flexibility to design a variety of residential ventilation systems that satisfy those requirements.

##### **Prescriptive Approach [Clause 9.32.3.1.(1)(b)]**

The prescriptively described systems are intended to provide a level of performance approaching that provided by systems complying with CAN/CSA-F326-M, "Residential Mechanical Ventilation Systems." They are included in the Building By-law for use by those less experienced in ventilation system design. Code users who do not find these prescriptively described systems

satisfactory for their purposes, or who find them too restrictive, are free to use any other type of ventilation system that satisfies the performance requirements of CAN/CSA-F326-M.

**A-9.32.3.2.(4) Duct Systems Serving More Than One Space.** Sentence 9.32.3.2.(4) requires heating or ventilation duct systems that serve any space in addition to a single dwelling unit to prevent the circulation of smoke upon a signal from a duct-type smoke detector. A duct system that serves a dwelling unit and a common space must be designed and installed to prevent the circulation of smoke.

**A-9.32.3.4. Principle Ventilation System Supply Air.**

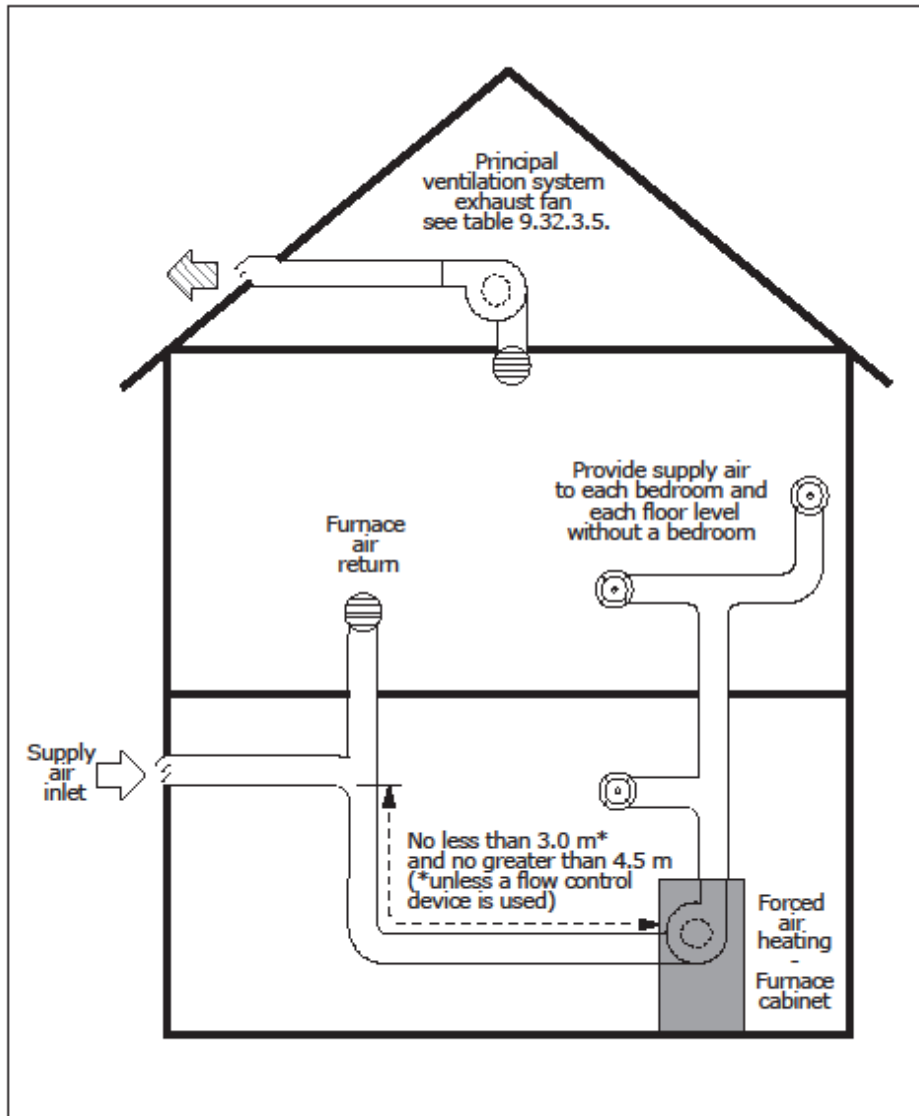


Figure A-9.32.3.4.(2)  
Forced-Air Heating System Supply Air Distribution

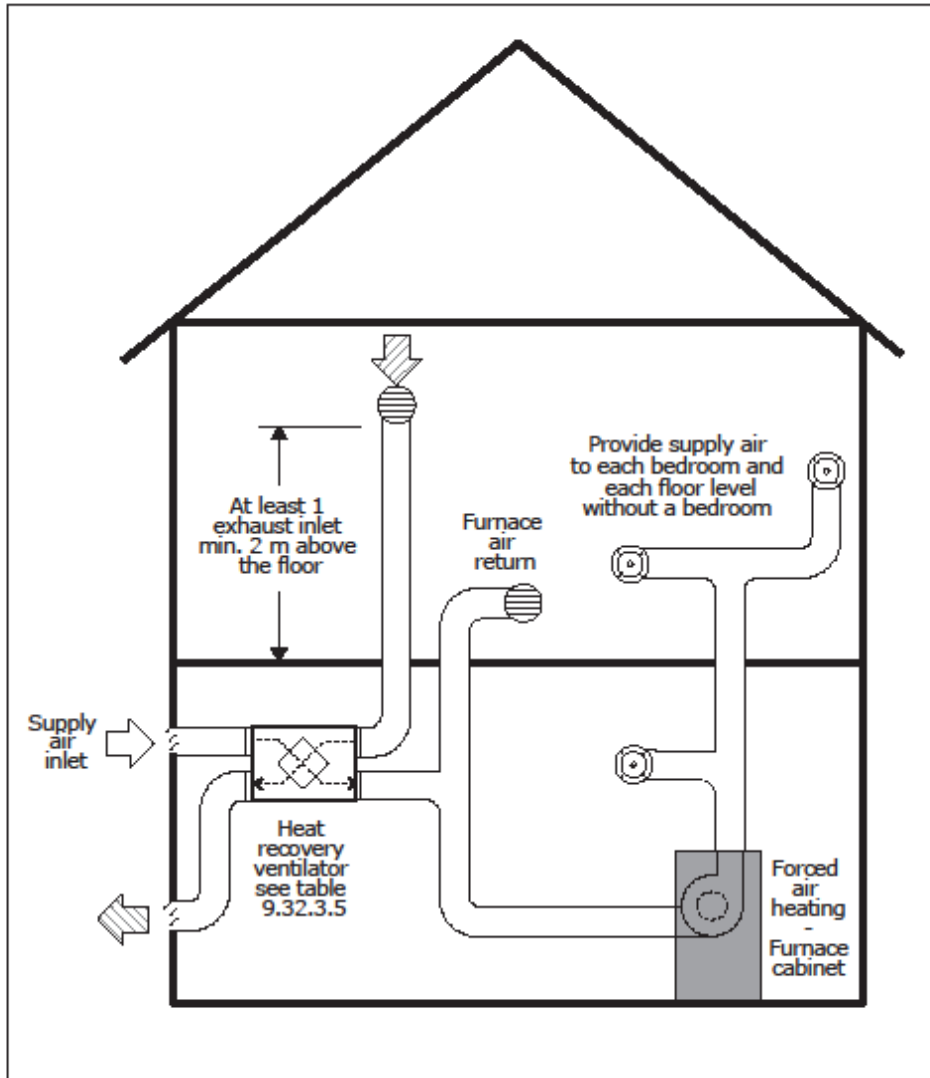


Figure A-9.32.3.4.(3)  
 Forced-Air Heating System with Heat Recovery Ventilator Supply Air Distribution



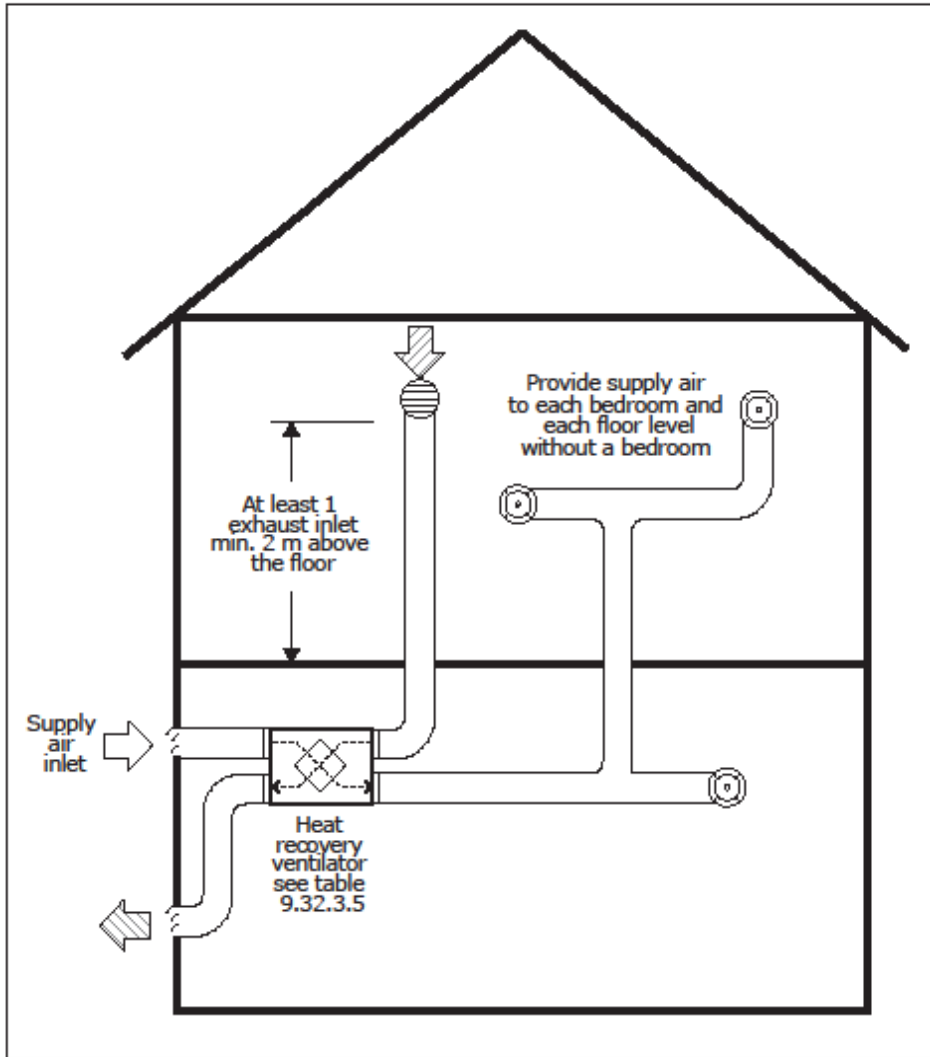


Figure A-9.32.3.4.(4)  
Heat Recovery Ventilator Supply Air Distribution

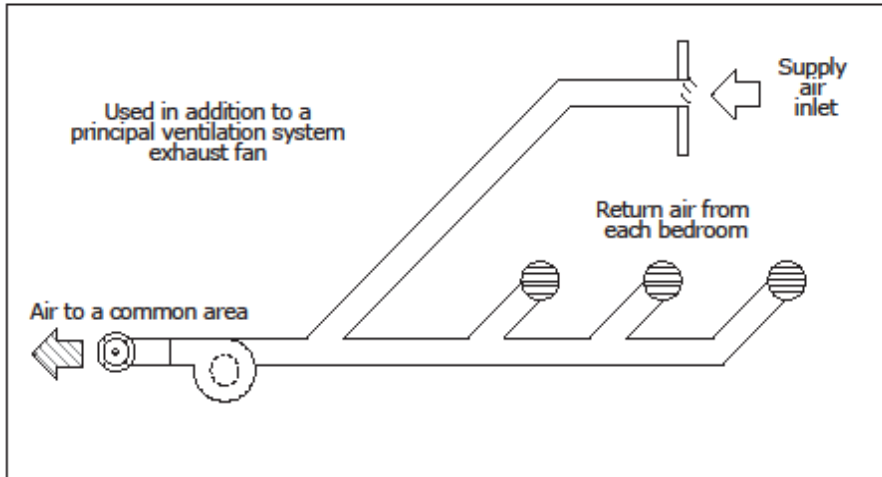


Figure A-9.32.3.4.(5)(b)(i)  
 Central Recirculation System Supply Air Distribution

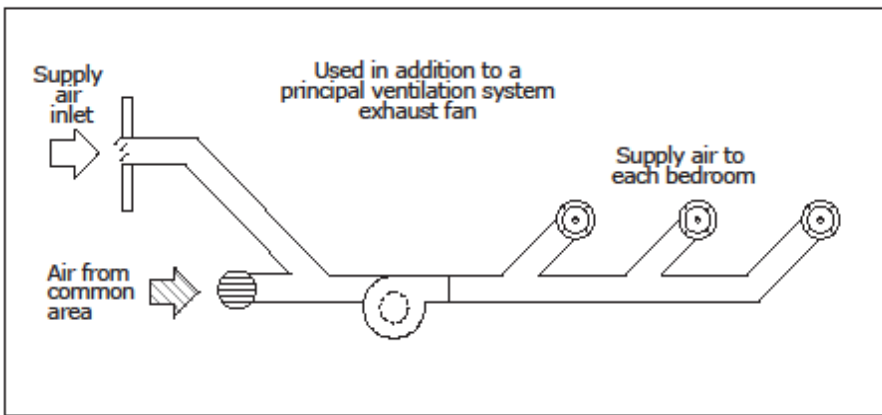


Figure A-9.32.3.4.(5)(b)(ii)  
 Central Recirculation System Supply Air Distribution

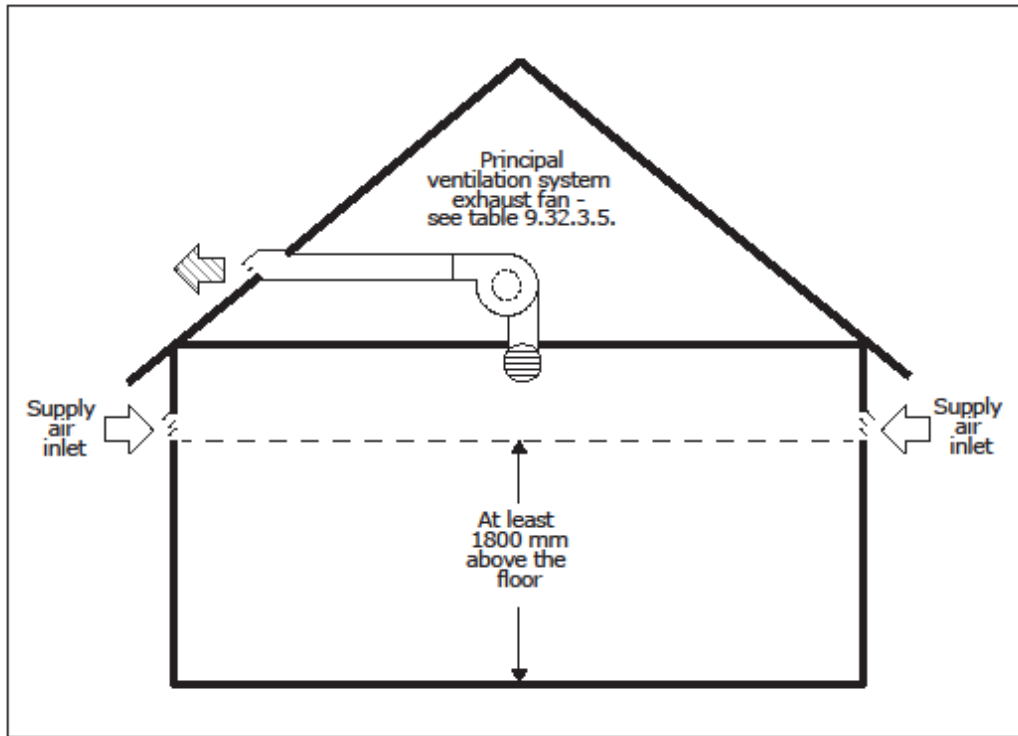


Figure A-9.32.3.4.(6)  
Passive Supply Air Distribution

**A-9.32.3.4.(6)(a)(ii) Floor Area Calculation for Passive Supply Air Distribution.** The floor area to be calculated for Subclause 9.32.3.4.(6)(a)(ii) does not include sun porches, enclosed verandas, vestibules, attached garages, or other spaces that are outside the building envelope and do not require ventilation supply air.

**A-9.32.4.1. Naturally Aspirating Fuel-Fired Vented Appliance (NAFFVA).** NAFFVA, typically appliances with draft hoods, are subject to back drafting when a negative pressure condition occurs in the dwelling. The following tables describe the conditions under which Sentence 9.32.4.1.(1) applies:

**Table A-9.32.4.1.(1)A.**  
**Vent Safety – Natural Gas and Propane**

Fuel Type	Natural Gas and Propane			
Vent Type	Power Vent <sup>(3)</sup>	Direct Vent <sup>(3)</sup>	Thermal Buoyancy Chimney <sup>(2)</sup>	
Appliance Type	Furnace Boiler HWT Fireplace	HWT Fireplace Heater	Mid-Efficient F/A Furnace or Boiler <sup>(5)</sup>	Drafthood Boiler HWT <sup>(4)</sup>
Special Conditions				Located in Air-Barriered Room <sup>(1)</sup>
Classification	Non-NAFFVA		NAFFVA	Non-NAFFVA
9.32.4.1.(1) Applies	No		Yes	No

**Notes to Table A-9.32.4.1.(1)A.:**

- (1) Mechanical room must be air-barriered from remainder of house with no access from within house. Room must be lined with panel products with sealed joints and all pipe and wire penetrations sealed. Effectively, the room must be finished before equipment is installed and holes drilled for pipes and wires. This option is not available for forced air furnaces as it is not possible to effectively seal the ducts.
- (2) Thermal buoyancy chimneys must be within the heated envelope of the house to provide acceptable venting performance.
- (3) Any power vented appliance with pressurized vent (1 pipe) or sealed combustion (2 pipe) or direct vent appliance (fireplace, heater or HWT) are non-NAFFVA.
- (4) Mid-efficient (draft induced) appliances are considered NAFFVA with the exception of a boiler or HWT located in an air-barriered room.
- (5) This category applies only to
  - (a) mid-efficient forced air furnaces equipped with induced draft fans and exhaust proving switch, and
  - (b) boilers equipped with induced draft fans and exhaust proving switch.

**Table A-9.32.4.1.(1)B.  
Vent Safety — Oil and Solid Fuel**

Fuel Type	Oil			Solid		
Vent Type	Thermal Buoyancy Chimney <sup>(2)</sup>		Direct Vent	Thermal Buoyancy Chimney <sup>(2)</sup>		Any
Appliance Type	Boiler HWT <sup>(4)</sup>	F/A Furnace Boiler HWT <sup>(3), (4)</sup>	F/A Furnace Boiler HWT	Boiler	F/A Furnace Boiler HWT Fireplace Heat Stove	Outside Boiler
Special Conditions	Located in Air-Barriered Room <sup>(1)</sup>			Located in Air-Barriered Room <sup>(1)</sup>		
Classification	Non-NAFFVA	NAFFVA	Non-NAFFVA	Non-NAFFVA	NAFFVA <sup>(5)</sup>	N/A
9.32.4.1.(1) Applies	No	Yes	No	No	Yes <sup>(5)</sup>	No

**Notes to Table A-9.32.4.1.(1)B.:**

- (1) Mechanical room must be air-barriered from remainder of house with no access from within house. Room must be lined with panel products with sealed joints and all pipe and wire penetrations sealed. Effectively, the room must be finished before equipment is installed and holes drilled for pipes and wires. This option is not available for forced air furnaces as it is not possible to effectively seal the ducts.
- (2) Thermal buoyancy chimneys must be within the heated envelope of the house to provide acceptable venting performance.
- (3) Oil-fired HWT, boilers and furnaces equipped with blocked vent switches.
- (4) Sealed combustion kits can be added to oil-fired appliances but they switch to interior combustion air if intake is blocked and rely on barometrically dampered thermal buoyancy chimneys so they are considered NAFFVA.
- (5) Wood-burning appliances certified for use in mobile homes and installed to mobile home installation standards are considered non-NAFFVA and Sentence 9.32.4.1.(1) does not apply to them.

**A-9.32.4.2. Carbon Monoxide Alarms.** Carbon monoxide (CO) is a colourless, odourless gas that can build up to lethal concentrations in an enclosed space without the occupants being aware of it. Thus, where an enclosed space incorporates or is near a potential source of CO, it is prudent to provide some means of detecting its presence.

Dwelling units have two common potential sources of CO:

- fuel-fired space- or water-heating equipment within the dwelling unit or in adjacent spaces within the building, and
- attached storage garages.

Most fuel-fired heating appliances do not normally produce CO and, even if they do, it is normally conveyed outside the building by the appliance's venting system. Nevertheless, appliances can malfunction and venting systems can fail. Therefore, the provision of

appropriately placed CO alarms in the dwelling unit is a relatively low-cost back-up safety measure.

Similarly, although Article 9.10.9.18. requires that the walls and floor/ceiling assemblies separating attached garages from dwelling units incorporate an air barrier system, there have been several instances of CO from garages being drawn into houses, which indicates that a fully gas-tight barrier is difficult to achieve. When the attached storage garage is located at or below the elevation of the living space, winter season stack action will generate a continuous pressure between the garage and the dwelling unit. This pressure is capable of transferring potentially contaminated air into the house. The use of exhaust fans in the dwelling unit may further increase this risk.

**A-9.33.1.1.(2) Combustion Air and Tight Houses.** The operation of an air exhaust system or of a fuel-burning appliance removes the air from a house, creating a slight negative pressure inside. In certain cases the natural flow of air up a chimney can be reversed, leading to a possible danger of carbon monoxide poisoning for the inhabitants.

Newer houses are generally more tightly constructed than older ones because of improved construction practices, including tighter windows, weather stripping and caulking. This fact increases the probability that infiltration may not be able to supply enough air to compensate for simultaneous operation of exhaust fans, fireplaces, clothes dryers, furnaces and space heaters. It is necessary, therefore, to introduce outdoor air to the space containing the fuel-burning appliance. Information regarding combustion air requirements for various types of appliances can be found in the installation standards referenced in Sentences 6.2.1.5.(1) and 9.33.5.2.(1). In the case of solid-fuel-burning stoves, ranges and space heaters, CSA B365, "Installation Code for Solid-Fuel-Burning Appliances and Equipment," suggests that the minimum size of openings be determined by trial and error to accommodate the flue characteristics, the firing rate, the building characteristics, etc., and that, as a guide, the combustion air opening should be 0.5 times the flue collar area.

Further information can be found in CBD 222, "Airtight houses and carbon monoxide poisoning," which is available from NRC.

**A-9.33.2.1.(2) Cooling.** Passive cooling designs can also be used to help reduce cooling loads to achieve the indoor design temperature specified in Sentence 9.33.3.1.(2).

**A-9.33.4.3.(1) Heating System Controls.** Where a single heating system serves two dwelling units and common spaces in a house with a secondary suite, it must be possible for the occupants to control the temperature in their own suites. Sentence 9.33.4.3.(1), which applies only to electric, fuel-fired or unitary heaters and hydronic heating systems, specifies that separate temperature controls must be provided in each dwelling unit in a house with a secondary suite; however, the controls for shared spaces may be located in those spaces or in one of the suites.

**A-9.33.4.4. Access to Equipment.** Mechanical equipment installed into a building is typically expected to undergo regular maintenance and testing so that the equipment remains at peak operational efficiency and can maintain a healthy air quality. Such maintenance may include flushing and cleaning, filter and part replacement, lubrication of moving components, and various safety checks. Building equipment should be located and oriented to provide adequate space for maintenance personnel to conduct all regular maintenance work without unreasonable effort. Confined spaces should be avoided, as should the creation of conditions that would dissuade regular maintenance, and sufficient clearances and headroom should be provided to reduce the risk of injury.

**A-9.33.5.3. Design, Construction and Installation Standard for Solid-Fuel-Burning Appliances.** CSA B365, "Installation Code for Solid-Fuel-Burning Appliances and Equipment," is essentially an installation standard, and covers such issues as accessibility, air for combustion and ventilation, chimney and venting, mounting and floor protection, wall and ceiling clearances, installation of ducts, pipes, thimbles and manifolds, and control and safety devices. But the standard also includes a requirement that solid-fuel-burning appliances and equipment satisfy the requirements of one of a series of standards, depending on the appliance or equipment, therefore also making it a design and construction standard. It is required that cooktops and ovens as well as stoves, central furnaces and other space heaters be designed and built in conformity with the relevant referenced standard.

**A-9.33.6.13. Return Air System.** It is a common practice to introduce outdoor air to the house by means of an outdoor air duct connected to the return air plenum of a forced air furnace. This is an effective method and is a component of one method of satisfying the mechanical ventilation requirements of Subsection 9.32.3. However, some caution is required. If the proportion of cold outside to warm return air is too high, the resulting mixed air temperature could lead to excessive condensation in the furnace heat exchanger and possible premature failure of the heat exchanger. CAN/CSA-F326-M, "Residential Mechanical Ventilation Systems," requires that this mixed air temperature not be below 15.5°C when the outdoor temperature is at the January 2.5% value. It is also important that the outdoor air and the return air mix thoroughly before reaching the heat exchanger. Note A-9.32.3. provides some guidance on this.

**A-9.33.10.2.(1) Factory-Built Chimneys.** Under the provisions of Article 1.2.1.1. of Division A, certain solid-fuel-burning appliances may be connected to factory-built chimneys other than those specified in Sentence 9.33.10.2.(1) if tests show that the use of such a chimney will provide an equivalent level of safety.

**A-9.34.2. Lighting Outlets.** The "Canadian Electrical Code, Part I" contains requirements relating to lighting that are similar to those in the Building By-law. However, the Electrical Code requirements apply only to residential occupancies, whereas many of the requirements in the Building By-law apply to all Part 9 buildings. By-law users must therefore be careful to ensure that all applicable provisions of the Building By-law are followed, irrespective of the limitations in the Electrical Code.

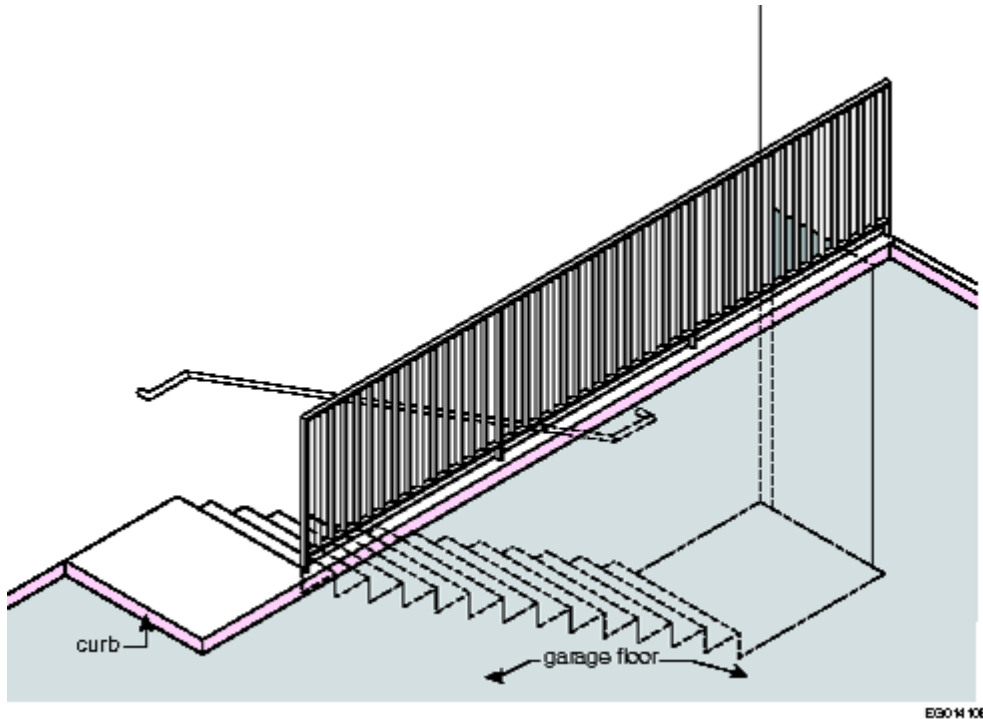
**A-9.35.2.2.(1) Garage Floor.** Sources of ignition, such as electrical wiring and appliances, can set off an explosion if exposed to gases or vapours such as those that can be released in garages. This provision applies where the frequency and concentration of such releases are low. Where the garage can accommodate more than 3 vehicles, and where wiring is installed within 50 mm of the garage floor, the "Canadian Electrical Code, Part I" should be consulted as it specifies more stringent criteria for wiring.

The capacity of the garage is based on standard-size passenger vehicles such as cars, mini-vans and sport utility vehicles, and half-ton trucks. In a typical configuration, the capacity of the garage is defined by the width of the garage doors – generally single or double width – which correlates to the number of parking bays.

In many constructions, floor areas adjacent to the garage are either above the garage floor level or separated from it by a foundation wall. Where the foundation wall is cast-in-place concrete and rises at least 50 mm above the garage floor, it can serve as the airtight curb. Where the foundation wall is block or preserved wood, extra measures may be needed to provide airtightness. In many instances, the construction will be required to be airtight to conform with Sentence 9.25.3.1.(1), and in any case, must comply with Sentences 9.10.9.18.(4) and (5).

Where the space adjacent to the garage is at the same level as the garage, a 50 mm curb or partition is not needed if the wall complies with Sentences 9.10.9.18.(4) and (5), and there is no

connecting door. Where there is a connecting door, if the garage is not sloped towards the exterior, it must be raised at least 50 mm off the floor or be installed so it closes against the curb. This requirement does not preclude the installation of a ramp leading from the garage floor up to the door.



**Figure A-9.35.2.2.(1)**

**Curb around garage floor at stairs**

In some instances, access to the basement is via a stair from the garage. In such cases, a curb must be installed at the edge of the stair well and must be sealed to the foundation wall, curb or partition between the garage and adjacent spaces.

See Figure A-9.35.2.2.(1).